

PRELIMINARY PLAT PORTOFINO LANDINGS

PLAT BOOK _____
PAGE _____

A PARCEL OF LAND LYING IN SECTION 19, TOWNSHIP 35 SOUTH, RANGE 40 EAST, CITY OF FORT PIERCE, ST. LUCIE COUNTY, FLORIDA.

DESCRIPTION

A PARCEL OF LAND LYING IN SECTION 19, TOWNSHIP 35 SOUTH, RANGE 40 EAST, ST. LUCIE COUNTY, FLORIDA, BEING MORE PARTICULARLY DESCRIBED AS FOLLOWS:

COMMENCE AT THE NORTHEAST CORNER OF SAID SECTION 19, THENCE N01°28'11"E ALONG THE EAST LINE OF SECTION 18, TOWNSHIP 35 SOUTH RANGE 40 EAST, A DISTANCE OF 357.41 FEET TO THE POINT OF INTERSECTION WITH THE NORTHERLY RIGHT-OF-WAY LINE OF OKEECHOBEE ROAD (AKA S.R. 70); THENCE S52°29'55"W ALONG SAID NORTHERLY RIGHT-OF-WAY LINE A DISTANCE OF 2102.04 FEET; THENCE CONTINUE ALONG THE AFORESAID NORTHERLY RIGHT-OF-WAY LINE FOR THE FOLLOWING THREE COURSES: S55°45'47"W, A DISTANCE OF 210.34 FEET; THENCE S52°29'33"W A DISTANCE OF 71.28 FEET; THENCE S52°26'41"W A DISTANCE OF 175.01 FEET TO THE POINT OF BEGINNING;

THENCE CONTINUE ALONG SAID NORTHERLY RIGHT-OF-WAY LINE S52°29'55"W A DISTANCE OF 50.00 FEET; THENCE DEPARTING SAID NORTHERLY RIGHT-OF-WAY LINE N37°30'05"W A DISTANCE OF 188.00 FEET; THENCE S52°29'55"W A DISTANCE OF 710.00 FEET TO THE EAST LINE OF A ROAD EASEMENT KNOWN AS PARCEL Q AS RECORDED IN OFFICIAL RECORD BOOK 874, PAGE 801, PUBLIC RECORDS OF ST. LUCIE COUNTY, FLORIDA; THENCE N37°30'05"W ALONG SAID EAST LINE A DISTANCE OF 29.99 FEET; THENCE N52°29'51"E A DISTANCE OF 719.99 FEET; THENCE N37°30'09"W A DISTANCE OF 480.50 FEET; THENCE S52°29'51"W A DISTANCE OF 715.50 FEET TO SAID EAST ROAD EASEMENT LINE AND A POINT ON THE ARC OF A CIRCULAR CURVE TO THE RIGHT AT WHICH A RADIAL LINE BEARS N65°10'05"E; THENCE NORTHERLY ALONG THE ARC OF SAID CURVE AND SAID EAST LINE, HAVING A RADIUS OF 595.00 FEET THROUGH A CENTRAL ANGLE OF 29°52'53", A DISTANCE OF 310.30 FEET TO A POINT OF COMPOUND CURVATURE OF A CIRCULAR CURVE TO THE RIGHT; THENCE NORTHERLY ALONG THE ARC OF SAID CURVE AND ALONG SAID EAST ROAD EASEMENT LINE, HAVING A RADIUS OF 2043.43 FEET AND A CENTRAL ANGLE OF 14°32'43", A DISTANCE OF 518.75 FEET TO A POINT OF TANGENCY; THENCE N19°35'36"E A DISTANCE OF 212.57 FEET TO A POINT OF INTERSECTION WITH THE SOUTHERLY RIGHT-OF-WAY LINE OF NORTH ST. LUCIE RIVER WATER CONTROL DISTRICT CANAL 37, AN 81.00 FOOT WIDE RIGHT-OF-WAY; THENCE ALONG SAID SOUTHERLY RIGHT-OF-WAY LINE FOR THE FOLLOWING TWO COURSES, FIRST N89°01'36"E A DISTANCE OF 315.07 FEET; THENCE N89°04'21"E, A DISTANCE OF 552.73 FEET TO A POINT OF INTERSECTION WITH THE WESTERLY RIGHT-OF-WAY LINE OF THE NORTH ST. LUCIE RIVER WATER CONTROL DISTRICT CANAL 29, A 131.00 FOOT WIDE RIGHT-OF-WAY; THENCE ALONG SAID WESTERLY RIGHT-OF-WAY LINE FOR THE FOLLOWING TWO (2) COURSES, FIRST S24°04'49"E A DISTANCE OF 10.27 FEET; THENCE S13°01'22"E A DISTANCE OF 469.48 FEET TO THE BEGINNING OF A TANGENT CIRCULAR CURVE TO THE LEFT, HAVING A RADIUS OF 443.72 FEET; THENCE SOUTHEASTERLY ALONG THE ARC OF SAID CURVE THROUGH A CENTRAL ANGLE OF 30°23'39", A DISTANCE OF 235.38 FEET; THENCE S78°53'23"W A DISTANCE OF 69.88 FEET TO A POINT OF CURVATURE OF A CIRCULAR CURVE TO THE RIGHT; THENCE NORTHERLY ALONG THE ARC OF SAID CURVE, HAVING A RADIUS OF 85.00 FEET AND A CENTRAL ANGLE OF 72°51'03", A DISTANCE OF 108.08 FEET TO A POINT OF TANGENCY; THENCE N28°15'34"W A DISTANCE OF 42.13 FEET TO A POINT OF CURVATURE OF A CIRCULAR CURVE TO THE RIGHT; THENCE NORTHERLY ALONG THE ARC OF SAID CURVE, HAVING A RADIUS OF 85.00 FEET AND A CENTRAL ANGLE OF 10°43'05", A DISTANCE OF 15.90 FEET; THENCE S76°13'19"W A DISTANCE OF 109.98 FEET; THENCE S52°26'19"W A DISTANCE OF 84.86 FEET; THENCE N37°24'29"W A DISTANCE OF 101.02 FEET; THENCE S52°35'31"W A DISTANCE OF 149.75 FEET; THENCE S37°24'29"E A DISTANCE OF 337.85 FEET; THENCE N52°29'33"E A DISTANCE OF 185.54 FEET; S37°30'27"E A DISTANCE OF 33.20 FEET; THENCE S52°29'55"W A DISTANCE OF 175.00 FEET; THENCE S37°30'05"E A DISTANCE OF 188.00 FEET TO THE POINT OF BEGINNING;

CONTAINING 18.851 ACRES (821,161 SQUARE FEET) MORE OR LESS.

DEDICATION

STATE OF _____
COUNTY OF _____

LANDINGS FORT PIERCE, LLC BY CREATIVE HOMES USA, LLC ITS GENERAL PARTNER DO HEREBY CERTIFY THAT THEY ARE THE OWNERS OF THE PROPERTY DESCRIBED HEREON AND HAVE CAUSED THE SAME TO BE SURVEYED AND PLATTED, AS SHOWN HEREON, AND DOES HEREBY DEDICATE AS FOLLOWS:

- 1) THE INSTALLATION AND MAINTENANCE OF THE LANDSCAPING WITHIN THE ROAD RIGHTS-OF-WAY SHALL REMAIN THE RESPONSIBILITY OF LANDINGS FORT PIERCE, LLC BY CREATIVE HOMES USA, LLC, IT'S SUCCESSORS AND/OR ASSIGNS.
- 2) THE DRAINAGE EASEMENTS (D.E.) AS SHOWN HEREON, ARE HEREBY DEDICATED TO LANDINGS FORT PIERCE, LLC BY CREATIVE HOMES USA, LLC, OR COMMUNITY DEVELOPMENT DISTRICT (C.D.D.), IT'S SUCCESSORS AND/OR ASSIGNS, AS A PRIVATE DRAINAGE EASEMENT FOR THE PURPOSE OF INSTALLATION OF DRAINAGE FACILITIES, AND ARE THE MAINTENANCE RESPONSIBILITY OF SAID OWNERS OR C.D.D.
- 3) THE WATER MANAGEMENT TRACTS (WMT) AS SHOWN HEREON, ARE HEREBY DEDICATED TO LANDINGS FORT PIERCE, LLC BY CREATIVE HOMES USA, LLC, OR COMMUNITY DEVELOPMENT DISTRICT (C.D.D.), IT'S SUCCESSORS AND/OR ASSIGNS, FOR WATER MANAGEMENT PURPOSES AND FOR WATER MANAGEMENT MAINTENANCE PURPOSES, AND ARE THE MAINTENANCE RESPONSIBILITY OF SAID OWNERS OR C.D.D.
- 4) THE INGRESS-EGRESS EASEMENT, AS SHOWN HEREON, IS HEREBY DEDICATED TO LANDINGS FORT PIERCE, LLC BY CREATIVE HOMES USA, LLC, OR COMMUNITY DEVELOPMENT DISTRICT (C.D.D.), IT'S SUCCESSORS AND/OR ASSIGNS, FOR ACCESS PURPOSES, AND IS THE MAINTENANCE RESPONSIBILITY OF SAID OWNERS OR C.D.D.
- 5) THE LIFT STATION EASEMENT, AS SHOWN HEREON IS HEREBY DEDICATED TO LANDINGS FORT PIERCE, LLC BY CREATIVE HOMES USA, LLC, OR COMMUNITY DEVELOPMENT DISTRICT (C.D.D.), IT'S SUCCESSORS AND/OR ASSIGNS, AS AN EXCLUSIVE EASEMENT FOR THE PURPOSES OF INSTALLATION OF WATER AND WASTEWATER FACILITIES AND IS THE MAINTENANCE RESPONSIBILITY OF SAID OWNERS OR C.D.D. SAID EASEMENT AS SHOWN HEREON IS ALSO DEDICATED IN FAVOR OF FORT PIERCE UTILITIES AUTHORITY (F.P.U.A.), ITS SUCCESSORS AND/OR ASSIGNS, FOR ACCESS TO, AND INSTALLATION AND MAINTENANCE OF PUBLIC UTILITY FACILITIES INCLUDING WATER AND WASTEWATER LINES AND APPURTENANT FACILITIES. THE F.P.U.A. SHALL NOT BE RESPONSIBLE FOR MAINTENANCE OBLIGATIONS FOR SAID EASEMENT EXCEPT AS SHALL RELATE TO THE SERVICING OF SUCH PUBLIC UTILITIES BY THE F.P.U.A.

DEDICATION (CONTINUED)

6) THE LANDSCAPE BUFFER EASEMENTS (LBE) AS SHOWN HEREON, ARE HEREBY DEDICATED TO LANDINGS FORT PIERCE, LLC BY CREATIVE HOMES USA, LLC, OR COMMUNITY DEVELOPMENT DISTRICT (C.D.D.), IT'S SUCCESSORS AND/OR ASSIGNS, FOR LANDSCAPE BUFFER PURPOSES AND ARE THE MAINTENANCE RESPONSIBILITY OF SAID OWNERS OR C.D.D.

LANDINGS FORT PIERCE, LLC

SIGNED AND SEALED THIS _____ DAY OF _____ 2017,
ON BEHALF OF LANDINGS FORT PIERCE, LLC BY CREATIVE HOMES USA, LLC ITS GENERAL PARTNER, BY ITS VICE PRESIDENT.

BY: LANDINGS FORT PIERCE, LLC BY CREATIVE HOMES USA, LLC ITS GENERAL PARTNER.

BY: _____
SALOMON SUTTON, MANAGER

PORTOFINO LANDINGS COMMUNITY DEVELOPMENT DISTRICT

SIGNED AND SEALED THIS _____ DAY OF _____ 2017,
ON BEHALF OF PORTOFINO LANDINGS COMMUNITY DEVELOPMENT DISTRICT

BY: PORTOFINO LANDINGS COMMUNITY DEVELOPMENT DISTRICT

BY: _____
TITLE:

ACKNOWLEDGMENT

STATE OF FLORIDA

COUNTY OF BROWARD

THE FORGOING INSTRUMENT WAS ACKNOWLEDGED BEFORE ME BY SALOMON SUTTON, MANAGER OF LANDINGS FORT PIERCE, LLC BY CREATIVE HOMES USA, LLC ITS GENERAL PARTNER. HE IS PERSONALLY KNOWN TO ME.

WITNESS MY HAND AND OFFICIAL SEAL IN THE COUNTY AND STATE LAST AFORESAID

THIS _____ DAY OF _____, 2017.

NOTARY PUBLIC
STATE OF FLORIDA

MY COMMISSION EXPIRES: TYPED, PRINTED, OR STAMPED NAME OF
NOTARY PUBLIC

ACKNOWLEDGMENT

STATE OF FLORIDA

COUNTY OF _____

THE FORGOING INSTRUMENT WAS ACKNOWLEDGED BEFORE ME BY _____ OF PORTOFINO LANDINGS COMMUNITY DEVELOPMENT DISTRICT, ITS _____ HE IS PERSONALLY KNOWN TO ME.

WITNESS MY HAND AND OFFICIAL SEAL IN THE COUNTY AND STATE LAST AFORESAID

THIS _____ DAY OF _____, 2017.

NOTARY PUBLIC
STATE OF FLORIDA

MY COMMISSION EXPIRES: TYPED, PRINTED, OR STAMPED NAME OF
NOTARY PUBLIC

SURVEYORS REVIEW CERTIFICATE

IT IS HEREBY CERTIFIED THAT THE UNDERSIGNED SURVEYOR AND MAPPER DULY LICENSED IN THE STATE OF FLORIDA HAS REVIEWED THIS PLAT FOR CONFORMITY WITH THE REGULATIONS OF CHAPTER 177, FLORIDA STATUTES.

THIS _____ DAY OF _____, 2017.

GREGORY S. FLEMING
PROFESSIONAL SURVEYOR & MAPPER
FLORIDA CERTIFICATE NO. 4350

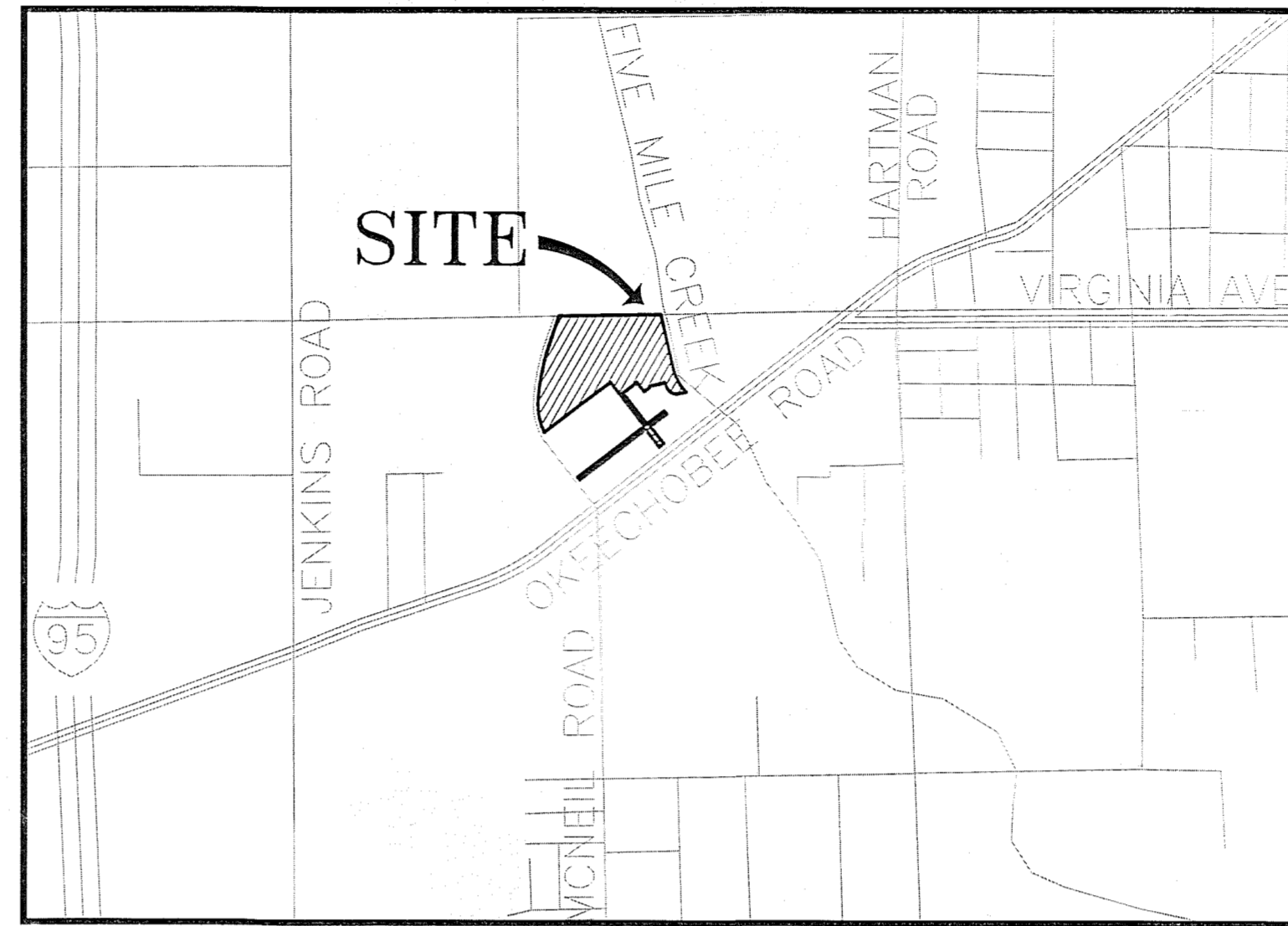
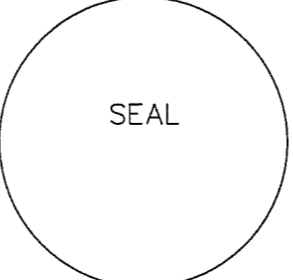

VICINITY MAP
NO SCALE

CITY COMMISSION CERTIFICATE

STATE OF FLORIDA
COUNTY OF ST. LUCIE SS

PURSUANT TO THE PROVISIONS OF THE FORT PIERCE CITY COMMISSION THIS PLAT WAS GIVEN FINAL APPROVAL BY THE CITY COMMISSION AT A MEETING HELD ON THIS _____ DAY OF _____ 2017. THIS PLAT HAS BEEN REVIEWED FOR CONFORMITY TO CHAPTER 177.011-177.151 FLORIDA STATUTES BY A PROFESSIONAL SURVEYOR AND MAPPER EMPLOYED BY OR UNDER CONTRACT WITH THE CITY OF FORT PIERCE, FLORIDA.

THIS _____ DAY OF _____, 2017.

FORT PIERCE CITY COMMISSION

BY: _____
LINDA COX
CITY CLERK

CLERK OF CIRCUIT COURT

STATE OF FLORIDA
COUNTY OF ST. LUCIE

I, JOSEPH E. SMITH, CLERK OF THE CIRCUIT COURT OF ST. LUCIE COUNTY, FLORIDA, DO HEREBY CERTIFY THAT THIS PLAT HAS BEEN EXAMINED AND THAT IT COMPLIES IN FORM WITH ALL THE REQUIREMENTS OF THE LAWS OF FLORIDA PERTAINING TO MAPS AND PLATS, AND THAT THIS PLAT HAS BEEN FILED OF RECORD IN PLAT BOOK _____ PAGES _____ OF THE PUBLIC RECORDS OF ST. LUCIE COUNTY, FLORIDA, THIS _____ DAY OF _____, 2017.

BY: _____
JOSEPH E. SMITH
CLERK OF THE CIRCUIT COURT
ST. LUCIE COUNTY, FLORIDA

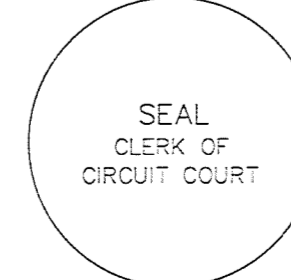

SURVEYORS CERTIFICATE

I, MICHAEL T. OWEN, DO HEREBY CERTIFY THAT (A) THIS PLAT OF PORTOFINO LANDINGS IS TRUE AND CORRECT AND WAS PREPARED FROM AN ACTUAL SURVEY OF THE PROPERTY MADE BY ME OR UNDER MY RESPONSIBLE DIRECTION AND SUPERVISION; (B) SAID SURVEY IS TRUE AND CORRECT TO THE BEST OF MY KNOWLEDGE AND BELIEF; (C) ALL PERMANENT REFERENCE MONUMENTS SHOWN HEREON ACTUALLY EXIST AND THEIR LOCATION, SIZE, TYPE, AND MATERIAL ADHERE TO THE REQUIREMENTS OF CHAPTER 177, FLORIDA STATUTES; AND (D) THE SURVEY DATA COMPLIES WITH ALL THE REQUIREMENTS OF CHAPTER 177, FLORIDA STATUTES, AS AMENDED, AND THE ORDINANCES OF THE CITY OF FT. PIERCE AND ST. LUCIE COUNTY, FLORIDA.

DATED THIS _____ DAY OF _____, 2017.

MICHAEL T. OWEN
PROFESSIONAL SURVEYOR & MAPPER
FLORIDA CERTIFICATE NO. 5556
CULPEPPER & TERPENING, INC.
2980 SOUTH 25TH STREET
FT. PIERCE, FL 34981

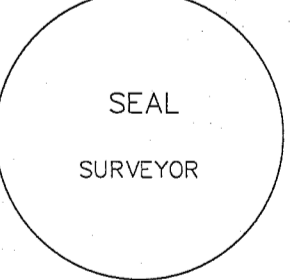

NOTES:

1. NOTICE: THIS PLAT, AS RECORDED IN ITS GRAPHIC FORM, IS THE OFFICIAL DEPICTION OF THE SUBDIVIDED LANDS DESCRIBED HEREIN AND WILL IN NO CIRCUMSTANCES BE SUPPLANTED IN AUTHORITY BY ANY OTHER GRAPHIC OR DIGITAL FORM OF THE PLAT. THERE MAY BE ADDITIONAL RESTRICTIONS THAT ARE NOT RECORDED ON THE PLAT THAT MAY BE FOUND IN THE PUBLIC RECORDS OF ST. LUCIE COUNTY, FLORIDA.
2. BEARINGS SHOWN HEREON ARE RELATIVE TO THE SOUTHWESTERLY RIGHT-OF-WAY LINE OF N.S.L.R.W.C.D. CANAL NO. 29 HAVING A BEARING OF N44°53'31"W.
3. PLAT CONTAINS 18.851 ACRES (821,161 SQUARE FEET), MORE OR LESS.
4. AN IRON ROD AND CAP, LB8098 HAS BEEN SET AT ALL LOT CORNERS AND CHANGES OF DIRECTION.

PREPARED BY MICHAEL T. OWEN
FLORIDA PROFESSIONAL SURVEYOR AND MAPPER No. 5556

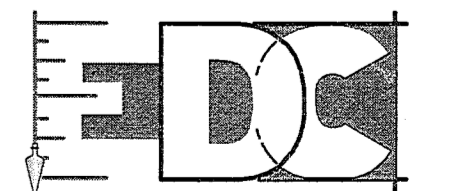

ENGINEERS SURVEYORS ENVIRONMENTAL

PORT SAINT LUCIE
10250 SW VILLAGE PARKWAY SUITE 201
PORT SAINT LUCIE, FL 34987
772-340-4990
www.edo-inc.com

F.B.P.E. CERTIFICATE OF AUTHORIZATION 9935
L.E. CERTIFICATE OF AUTHORIZATION 8098

EDC PROJECT #5-16-223

PRELIMINARY PLAT PORTOFINO LANDINGS

PLAT BOOK _____
PAGE _____

A PARCEL OF LAND LYING IN SECTION 19, TOWNSHIP 35 SOUTH, RANGE 40 EAST, CITY OF FORT PIERCE, ST. LUCIE COUNTY, FLORIDA.

NORTH

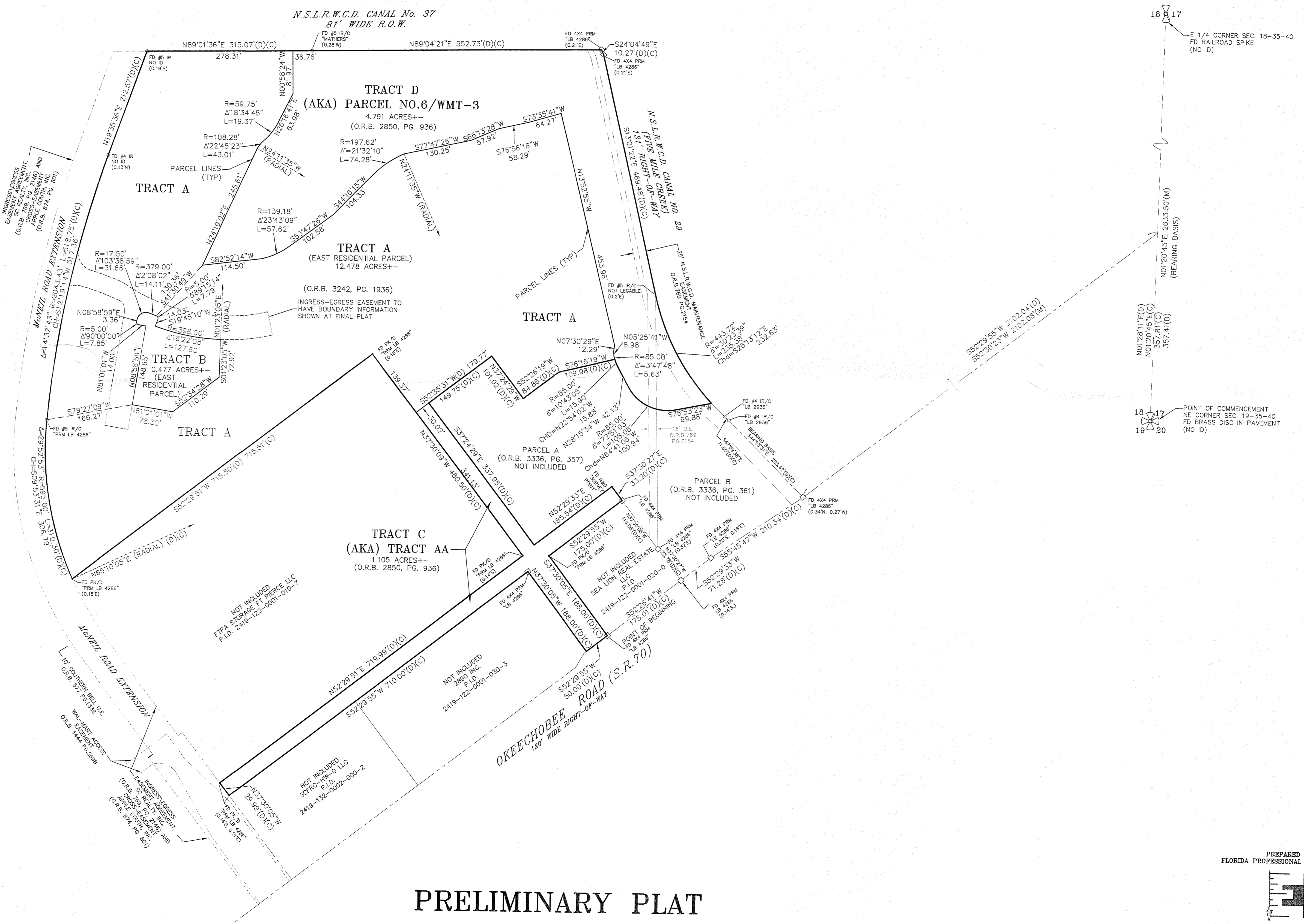
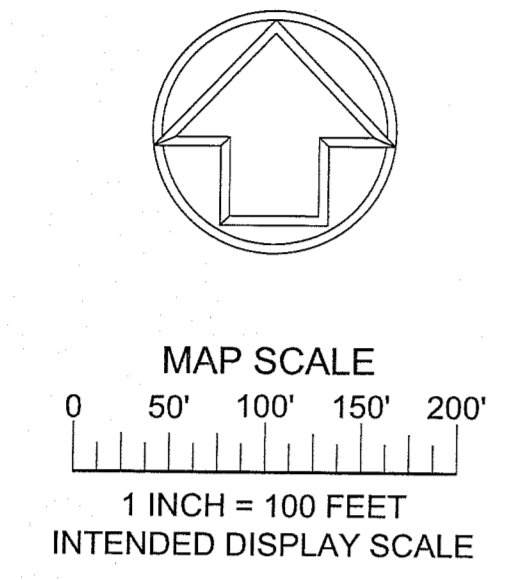

PRELIMINARY PLAT

PREPARED BY MICHAEL T. OWEN
FLORIDA PROFESSIONAL SURVEYOR AND MAPPER No. 5566

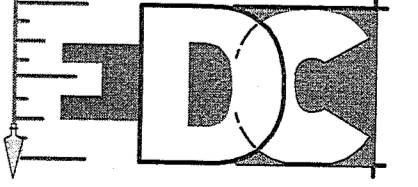

ENGINEERS SURVEYORS ENVIRONMENTAL
PORT SAINT LUCIE
10250 SW VILLAGE PARKWAY SUITE 201
PORT SAINT LUCIE, FL 34987
TEL 772-340-4990
WWW.EDC-INC.COM

F.P.E. CERTIFICATE OF AUTHORIZATION 9935
L.B. CERTIFICATE OF AUTHORIZATION 8098
EDC PROJECT #5-16-223 SHEET 2 OF 4

I:\EDC-Survey\Project Files\16-223 Portofino Landings\Drawings\16-223 PREP.PLT.dwg, 1/27/2017 2:28:04 PM, Mark

PRELIMINARY PLAT
PORTOFINO LANDINGS

A PARCEL OF LAND LYING IN SECTION 19, TOWNSHIP 35 SOUTH, RANGE 40 EAST, CITY OF FORT PIERCE, ST. LUCIE COUNTY, FLORIDA.

PLAT BOOK _____
PAGE _____

NORTH

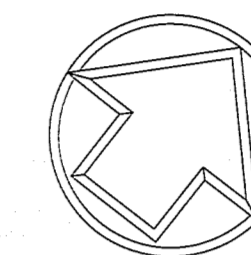

MAP SCALE
0 25' 50' 75' 100'
1 INCH = 50 FEET
INTENDED DISPLAY SCALE

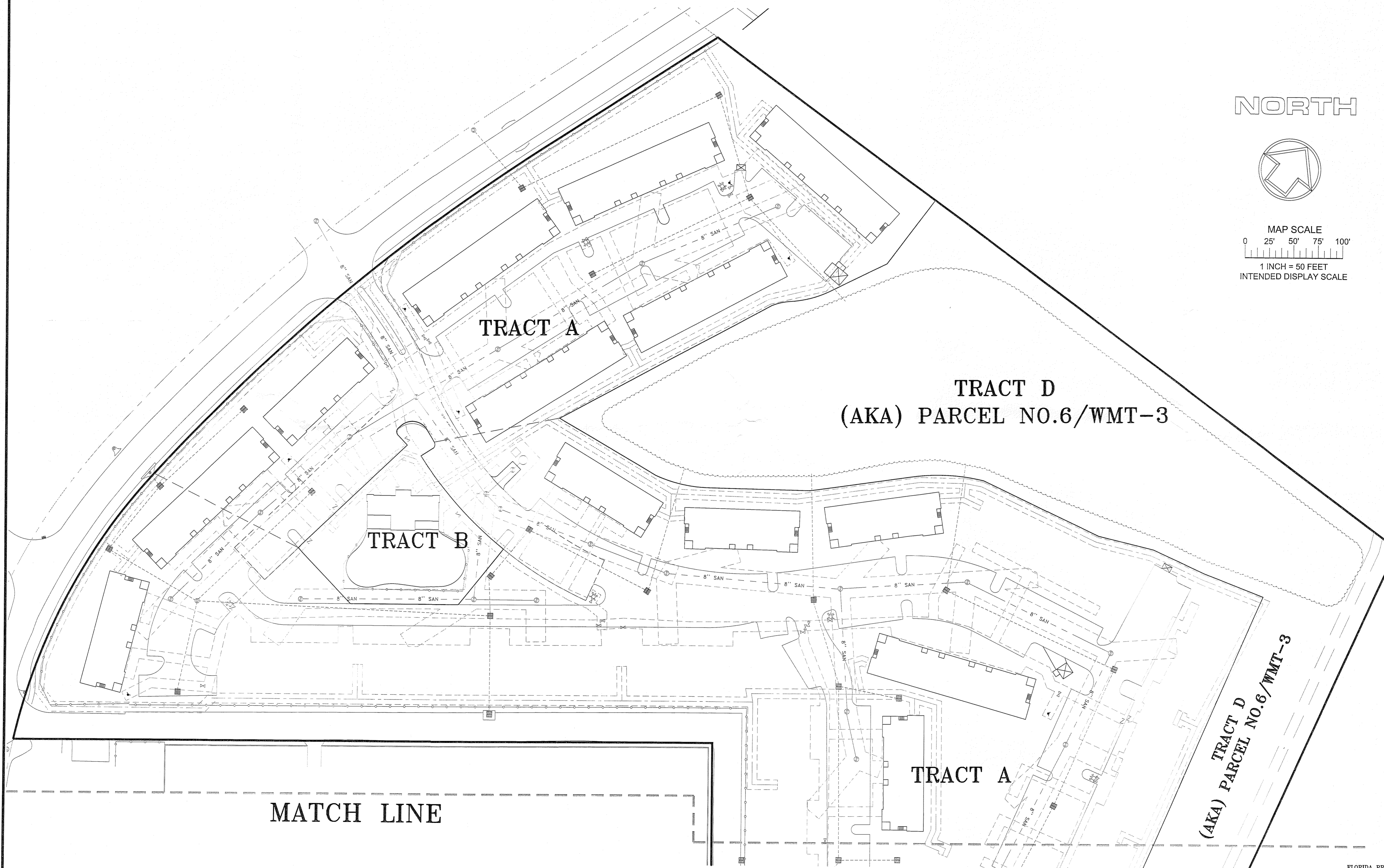

PREPARED BY MICHAEL T. OWEN
FLORIDA PROFESSIONAL SURVEYOR AND MAPPER No. 5556

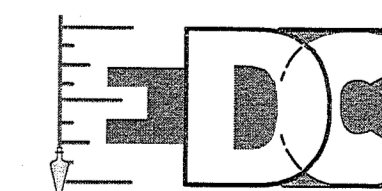

ENGINEERS • SURVEYORS • ENVIRONMENTAL

PORT SAINT LUCIE
10250 SW VILLAGE PARKWAY SUITE 201
PORT SAINT LUCIE, FL 34987
772-340-4990
www.edc-inc.com

F.S.P.E. CERTIFICATE OF AUTHORIZATION 8935
L.B. CERTIFICATE OF AUTHORIZATION 8098
EDC PROJECT #S-16-223

SHEET 3 OF 4

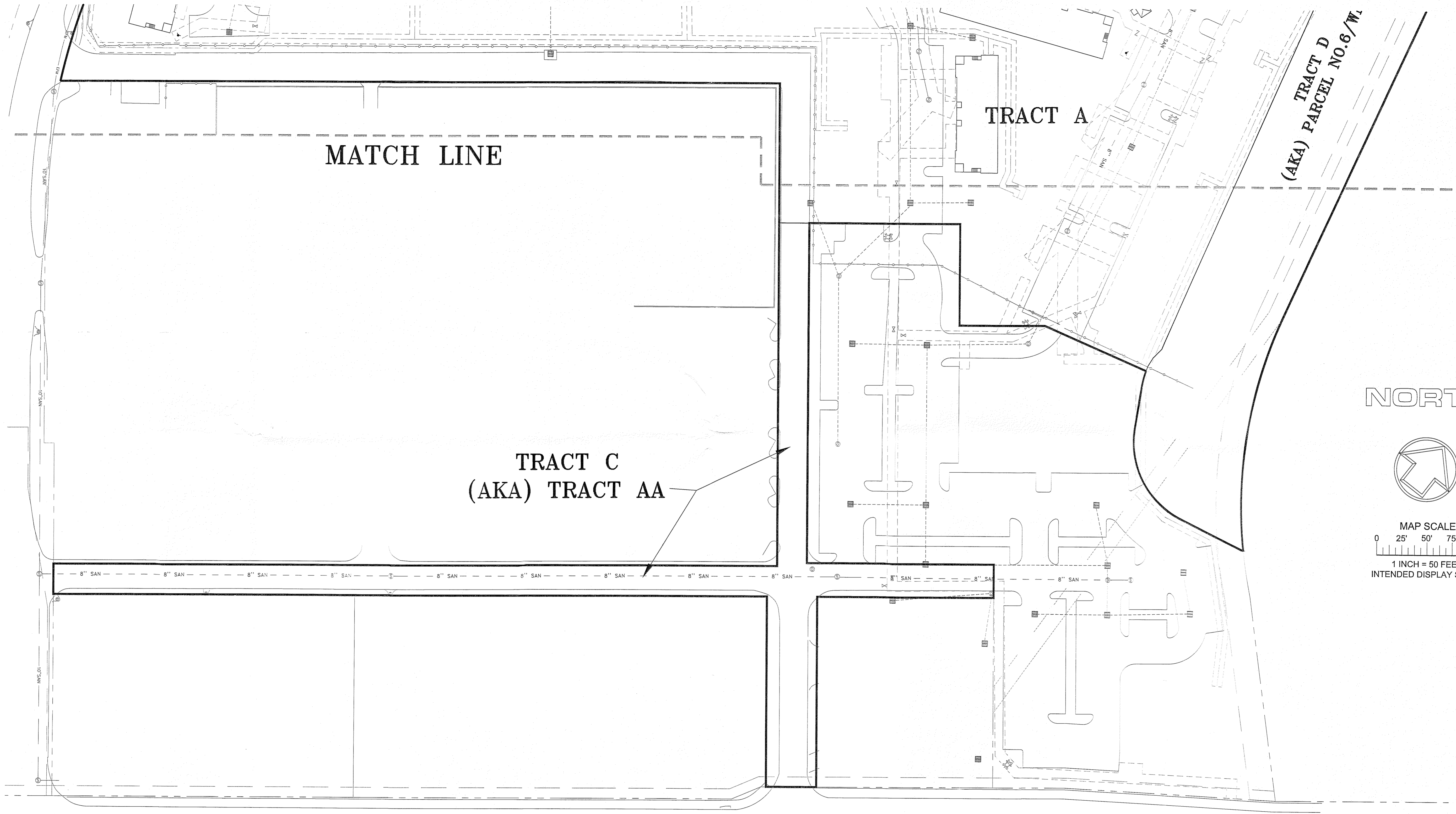

THIS DOCUMENT, TOGETHER WITH THE CONCEPTS AND DESIGNS PRESENTED HEREIN, AS AN INSTRUMENT OF SERVICE, IS INTENDED ONLY FOR THE SPECIFIC PURPOSE AND CLIENT FOR WHICH IT WAS PREPARED. REUSE OF AND IMPROPER RELIANCE ON THIS DOCUMENT WITHOUT WRITTEN AUTHORIZATION AND ADOPTION BY EDC, INC. SHALL BE WITHOUT LIABILITY TO EDC, INC.

NORTH

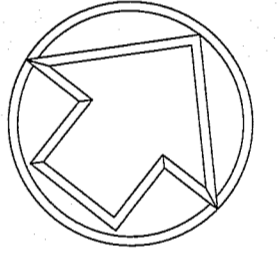

MAP SCALE
0 25' 50' 75' 100'
1 INCH = 50 FEET
INTENDED DISPLAY SCALE

PREPARED BY MICHAEL T. OWEN
FLORIDA PROFESSIONAL SURVEYOR AND MAPPER No. 5556

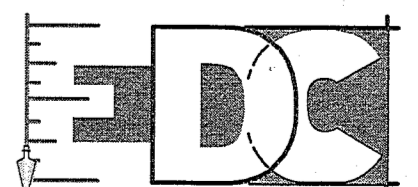

ENGINEERS SURVEYORS ENVIRONMENTAL

PORT SAINT LUCIE
10255 SW VILLAGE PARKWAY SUITE 201
PORT SAINT LUCIE, FL 34987
772-340-4990
www.edc-inc.com

F.B.P.E. CERTIFICATE OF AUTHORIZATION 9935
L.B. CERTIFICATE OF AUTHORIZATION 8098
EDC PROJECT #S-16-223

EDC Survey\Project Files\16-223 Portofino Landings\Drawings\Survey\16-223 PREPLAT.dwg, 1/27/2017 12:52:50 PM, Mark Jobe FDR:pc5