

PROJECT NARRATIVE & COVER LETTER
Flagship Storage
Development, Design, Concurrency & Conditional Use Review
 Revised November 16, 2021

REQUEST

On behalf of the Petitioner, Engineering Design & Construction, Inc. would like to request approval of a project known as Flagship Storage. The project includes the construction of approximately 111,517 sf of self-storage along with a covered 6,300 sf RV Storage area with associated site improvements. The subject parcels are noted below are located on the east side of Jenkins Road north of Okeechobee Road in the City of Fort Pierce, Florida.

SITE CHARACTERISTICS & PROJECT HISTORY

The subject parcels can be identified in the below table:

Petitioner Parcel ID:	Address:	Acreage:	FLU:	Zoning:
2419-603-0003-000-4	Jenkins Road (TBD)	3.23	GC	C-3
2419-603-0004-000-1	Jenkins Road (TBD)	1.50	GC	C-3

The subject parcels have a Future Land Use designation of General Commercial (GC) and an underlying Zoning designation of General Commercial Zone (C-3). The petitioner is proposing one (1) three (3) story self-storage building, five (5) single story self-storage buildings and a covered RV storage area with associated site improvement.

The current owner of the parcels is:

NNN/1031 # 16 Jenkins LLC
 2 Towne Square, Suite 900
 Southfield, MI 48076

The contract purchaser and developer for the proposed development is:

Flagship Companies Group, LLC
 1190 Business Center Drive, Suite 2000
 Lake Mary, FL 32746

To the north of the subject parcels lies an undeveloped commercial parcel. This parcel has a Future Land Use designation of General Commercial (GC) and an underling Zoning designation of General Commercial Zone (C-3).

To the south of the subject parcels lies developed commercial parcels. The southeast corner has a construction Walgreens and the southwest corner has a constructed Chick-Fil-A. These parcels have a Future Land Use designation of General Commercial (GC) and an underling Zoning designation of General Commercial Zone (C-3).

West of the subject parcels lies the right-of-way of S. Jenkins Road followed by a developed parcel that lies within the jurisdiction of St. Lucie County. This parcel has a Future Land Use designation of Mixed-Use Development (MXD) and an underlying Zoning designation of Commercial, General (CG).

Southeast of the subject parcels is a developed Starbucks that is located within the City of Fort Pierce. This parcel has a Future Land Use designation of General Commercial (GC) and an underlying Zoning designation of General Commercial Zone (C-3). To the north east are developed residential parcels that are located in the jurisdiction of St. Lucie County. These parcels have a Future Land Use designation of Commercial and an underlying Zoning designation of Commercial, Office (CO).

Development Review:

Section 125-313 outlines the requirements for approval of a Major Site Plan application. This submittal package includes the development, design and concurrency review application materials as required. Most of the items are included as part of this submittal.

- A pre-application meeting was held with City staff on June 2, 2021 to discuss the proposed development.
- A beach / dune system protection plan is not included as it is not applicable for the proposed project.

Design Narrative:

Section 125-314 outlines the requirements for Design Review. The design for building integrates various architectural elements to sub-divide the massing and scale of the self-storage use. The main entrance at the corner is emphasized with height and glass to portray a clear landmark for patrons and display the colorful doors within. The awning projection wraps around the corner and provides cover. Beyond the corner entry, the length of wall includes split face block at the first level with textured panels above and EIFS (stucco look) finish at the parapet level. The split face block relates to a human scale and texture at the first floor. The textured panels are a vertical orientation that span the two upper levels. The EIFS finish at the top continues as a horizontal banding. The pilasters project out from the face and rise above the main parapet level, providing depth, shadow and breaking up the length of the façade. The light fixtures located on these pilasters further highlight the rhythm.

Overall, there are four colors being utilized, but all within a related earth-tone neutral scheme. All the corners are highlighted with the darker tone to anchor the design. Glass and Metal awnings are additional materials that signify featured elements and function. The building height is varied as well.



There are a number of specimen trees and other natural vegetation that exist onsite. This application includes a tree inventory report and estimated cost of mitigation for review and approval. A boundary and topographic survey are included as part of this application also.

Adjacent to the proposed development are commercial and residential parcels. North of the subject parcel lies an undeveloped commercial site.



South of the subject parcel are developed commercial parcels. Walgreens is located to the southwest of the site which is at the corner of Jenkins Road and Okeechobee Road. To the southeast of the subject parcel is a developed Chick-fil-A.



Southeast of the subject parcels is a constructed Starbucks Coffee Shop. To the northeast of the parcels are two (2) residential homes. The residential parcels are located in St. Lucie County.



West of the subject parcels is a commercial parcel which includes a residential home. Commercial activity is present from the site photos obtained.



Concurrency Review:

Section 105.6 outlines the requirements for Concurrency Review. Included with this submittal, please find the completed capacity analysis which reviews impacts to water, wastewater, parks, schools, solid waste, stormwater and transportation for review and approval.

Conditional Use Review:

Section 125-236 outlines the application requirements for approval of a conditional use. Section 125-187 outlines the allowed uses within the C-3 Zoning designation. Self-Service Storage is allowed as a conditional use within this Zoning designation. This application includes the request for approval of self-storage as a conditional use.

Based on the above and attached information, the applicant respectfully requests approval of the attached applications.

Z:\EDC-2021\21-241 - Flagship Storage - Jenkins & Okeechobee\ENGINEERING\Documents\Submittal Documents\Justification Statement\2021-11-16_Revise\Flagship_Storage_Jenkins_Orange_Dev_Design_Concurrency_Justification_Strmt_21-241.docx



DEVELOPMENT REVIEW

Property address or Location Jenkins Road
 Parcel ID #(s) 2419-603-0003-000-4 and 2419-603-0004-000-1
 Project description Development includes a 3-story storage building totaling 93,840 sf, and five (5) one-story storage buildings totaling 11,377 sf with associated improvements. Site plan also proposes 6,300 sf of covered RV parking spaces.

NNN/1031 # 16 Jenkins LLC
 Property Owner(s)
2 Towne Square, Suite 900
 Street Address
Southfield MI 48076-3761
 City State Zip
541-630-6110
 Phone Number
kgeller@ramrealestate.com
 Email Address

Flagship Companies Group, LLC, Phillip C. Hollis, AuthAgent
 Applicant/Representative, Title, Company
1190 Business Center Drive #2000
 Street Address
Lake Mary FL 32746
 City State Zip
407.832.6444 (PCH) & 772.812.8264 BradCurrieEDC)
 Phone Number
Phillip@PMJS.com & bradcurrie@edc-inc.com
 Email Address

Note: Owner's Agent (Flagship) authorizes EDC, Inc, Brad Currie, VP as Agent's representative.

Property Owner(s) Acknowledgements: - This application will not be considered complete without the signature of all property owners of record, which shall serve as an acknowledgement of the submission of this application. The property owner's signature below shall also authorize the Applicant (if other than the property owner) and/or Representative to act in his/her behalf for the purposes of seeking approval for the application described herein. The undersigned consents to inspection and photographing of the subject property by the Planning staff for purposes of consideration of this Application and/or presentation to the Planning Board and City Commission.

[Signature]
 Property Owner(s) Signature(s)

STATE OF FLORIDA -- COUNTY

The foregoing instrument was acknowledged before me this 6th day of December, 2021, by

Bradley J. Currie who is personally known to me or has produced

as identification.

[Signature]
 Signature of Notary

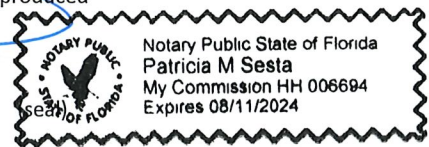

INTAKE MEETINGS ARE REQUIRED FOR ALL SUBMITTALS. CALL (772) 467-3729

TO BE COMPLETED BY STAFF

Zoning	Future Land Use	Total Acres	Historic District	Historic Designation
				Contributing Individual Non-Contributing None

Pre-Application Meeting Date _____ Fees _____ Control # _____ B. Permit # _____
 Intake Planner _____
 Planner Assigned _____
 Approved By _____ Date _____
 Comments _____

Intake Date Stamp



DEVELOPMENT REVIEW

General Information

- Incomplete application packets cannot be accepted.
- Site Plan approval is valid for one (1) year following City Commission approval. In order to maintain site plan approval, vertical improvements, permitted by the Building Department must commence prior to the 12-month expiration date, and building permits must be maintained until site plan is completed, per plans, or approval shall lapse.

Choose Application Type:

Application Type			
<input type="checkbox"/> Site Plan	<input checked="" type="checkbox"/> Conditional Use with New Const.	<input type="checkbox"/> Major Amendment	
<input type="checkbox"/> Conceptual Development Plan		<input type="checkbox"/> Minor Amendment	

Site Information:

111,517 sf

Non-Residential: Proposed Sq. Ft.: _____

Residential: Proposed Units: _____

Surrounding Uses: (i.e. single family home, retail, industrial, etc.)

North	South	East	West
Undeveloped	Walgreens/Chick-fil-A	Residential	Residential

Application Outlook



Site Plan submittal requirements:

Submit one (1) original & thirteen (13) hard copies and one (1) CD of the following. Additional copies will be required of subsequent submittals.

- Complete notarized application
- Warranty Deed
- SLC Property Record Card
- Statements of ownership & control of proposed development. Statement describing in detail: character & intended use.
- General location map (see Section 22-58.d.2)
- Survey (see Section 22-58.d.3)
- Site Plan (see Section 22-58.d.4)
- Landscaping Plan (see Section 22-187)
- Storm Drainage Plan (see Section 22-58.d.6)
- Environmental Impact Report
- Beach/Dune System protection plan, if applicable (see Section 22-58.d.7)
- Lighting Plan (see Section 22-58.d.8)
- Design Review submittals (see Design Review application)
- Traffic Impact Report
- Concurrency Review submittals (see Concurrency Review application)



Design Review

Property address or Location Jenkins Road, North of Okeechobee

Parcel ID #(s) 2419-603-0003-000-4 and 2419-603-0004-000-1

Project Description Development of a 3-story storage building totaling 93,840 sf and (5) five-(1) story storage buildings

totaling 11,377 sf and 6,300 sf of covered RV parking spaces with associated site improvements.

NNN/1031 # 16 Jenkins, LLC
Property Owner(s)

2 Towne Square, Suite 900
Street Address

Southfield MI 48076-3761
City State Zip

772.285.1674
Phone Number

Nicholas Roland <nroland@ramrealestate.com>
Email Address

Flagship Companies Group, LLC, Phillip C. Hollis, AuthAgent
Applicant/Representative, Title, Company

1190 Business Center Drive #2000
Street Address

Lake Mary FL 32746
City State Zip

407.832.6444 (PCH) & 772.812.8264 BradCurrieEDC
Phone Number

Phillip@PMJS.com & bradcurrie@edc-inc.com
Email Address

Note: Owner's Agent (Flagship) authorizes EDC, Inc, Brad Currie, VP as Agent's representative.
Property Owner(s) Acknowledgements: - This application will not be considered complete without the signature of all property owners of record, which shall serve as an acknowledgement of the submission of this application. The property owner's signature below shall also authorize the Application (if other than the property owner) and/or Representative to act in his/her behalf for the purposes of seeking approval for the application described herein.

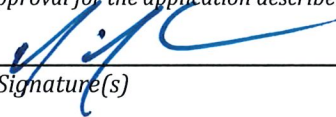
Property Owner(s) Signature(s)

STATE OF FLORIDA -- COUNTY
The foregoing instrument was acknowledged before me this 6th day of December, 20 21, by

Bradley J. Currie who is personally known to me or has produced
as identification.

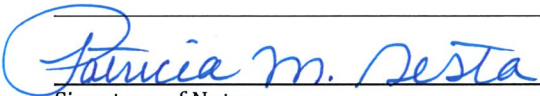
Signature of Notary



TO BE COMPLETED BY STAFF

Zoning	Future Land Use	Total Acres	Historic Districts	Historic Designation

Pre-Application Meeting Date _____ Fees _____ Control # _____ B. Permit _____

Intake Planner _____

Planner Assigned _____

Approved _____ Date _____

Comments _____

Intake Date Stamp

Design Review Application Checklist

(City Code of Ordinances 22-59)

Submittal for Administrative Approval

- a. A survey (1" = 30' minimum scale) of property lines, existing topography and the location of trees meeting the tree protection regulations of section 22-194, location of bordering streets and, if applicable, wetlands and beaches.
- b. A site analysis study to include a discussion of specimen trees and other natural vegetation, access, significant topography, wetlands, buffers, setbacks, views, orientation, the surrounding built environment and other site features that may influence design elements.
- c. A draft written narrative describing the design intent of the project, its goals and objectives and how it reflects the site analysis study results.
- d. Context photographs of neighboring uses and architectural styles.
- e. Photographs and/or drawings of architectural buildings or objects that serve as a precedent for the proposed building design. Models should be taken from local exemplary buildings, either existing or demolished. Documentation of such buildings is available in the city's planning department.
- f. Photographs of all existing structures located on the property. If existing structures on the property are more than fifty (50) years of age, documentation of these structures with data from the Florida Master Site File form is also required.
- g. Conceptual site plan (to scale) showing proposed location of all buildings, structures, parking areas, signs and landscaping.
- h. Landscape plan, at the same scale as the site plan. The planning director or designee may request enlarged plans of detailed planting areas. Planting schedule with sizes of proposed plantings must be included.
- i. Accurate color rendering of proposed signs showing dimensions, type of lettering, materials and actual color samples that demonstrates cohesiveness with the project design.
- j. Exterior elevations showing architectural character, external architectural features and streetscape of the proposed development, including materials, colors, shadow lines and landscaping. The street elevation shall encompass the entire proposed project and generally identify the major elements of the adjacent two (2) properties on either side of the site. If the adjacent properties are vacant or underutilized, a diagram shall be provided that identifies the mass and form that is allowable under current zoning. If the street elevation must be drawn at such a scale as to render architectural details of the building unreadable, drawings of individual buildings at a larger scale should be provided as well.
- k. Design review concurrent with conceptual development plan procedure according to subsection 22-58(e) is also available.

Submittal for Board Approval

- a. A written narrative describing how the project conforms to administrative approval and design review guidelines of this section.
- b. A final site plan meeting the requirements of section 22-58
- c. A final site lighting plan that meets the requirements of subsection 22-58(d)(8).
- d. A final landscape plan that meets the requirements of Article XII, Landscaping and Trees.
- e. Final floor plans and elevation drawings (1/8" = 1'-0" minimum scale), as detailed under administrative approval, showing exterior building materials and colors with architectural sections and details to adequately describe the project.
- f. A color board (11"x17" maximum) containing actual color samples of all exterior finishes, keyed to the elevations, and indicating the manufacturer's name and color designation.

NNN/1031 NO. 16 SR 70 JENKINS LLC
c/o Ram Realty Advisors LLC
4801 PGA Boulevard
Palm Beach Gardens, FL 33418

AGENT CONSENT FORM

Project Name: Jenkins & Okeechobee

Parcel ID: 2419-603-0003-000-4 and 2419-603-0004-000-1 ("Property")

BEFORE ME THIS DAY PERSONALLY APPEARED Keith L. Cummings, WHO BEING DULY SWORN, DEPOSES AND SAYS THE FOLLOWING:

I hereby give CONSENT to Phillip C. Hollis, as Agent for Flagship Companies Group, LLC ("Applicant") to act on my behalf, to submit or have submitted applications and all required material and documents, and to attend and represent me at all meetings and public hearings pertaining to all City, County and State permits for completion of a 100,000+ sf self-storage facility. Notwithstanding the foregoing, any and all terms and conditions which may arise as part of the approval of this application for the proposed use of a self-storage facility that will be binding on the Property or the Property Owner prior to the purchase of the Property by the Applicant shall require a separate written approval from Keith L. Cummings, as Manager of the Property Owner.

FURTHER AFFIANT SAYETH NOT.

The foregoing instrument was acknowledged before me by means of physical presence or online notarization, this 5th day of May, 2021, by Keith L. Cummings (Name of Person Acknowledging) who [XX] is personally known to me or who has produced _____ (type of identification) as identification and who did (did not) take an oath.



Notary Signature

Karen D. Geller

Printed Name of Notary

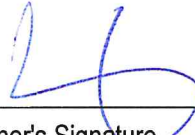

Owner's Signature

NNN/1031 NO. 16 SR 70 JENKINS LLC, a Florida limited liability company
By: Keith L. Cummings, Manager

Owner's Name

4801 PGA Boulevard

Street Address

Palm Beach Gardens, FL 33418

City, State, Zip

561-630-6110/ kgeller@ramrealestate.com

Telephone / Email

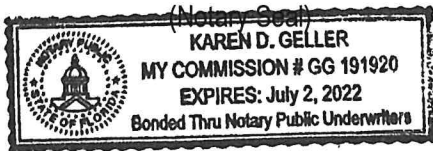

My commission expires

Flagship

COMPANIES GROUP

AGENT CONSENT FORM

Project Name: Jenkins & Okeechobee

Parcel ID: 2419-603-0003-000-4 and 2419-603-0004-000-1

BEFORE ME THIS DAY PERSONALLY APPEARED Phillip C. Hollis, Flagship Companies Group, LLC as Property's Owner's Agent, WHO BEING DULY SWORN, DEPOSES AND SAYS THE FOLLOWING:

I hereby give CONSENT to **Brad Currie, Engineering Design & Construction, Inc.** to act on my behalf, to submit or have submitted applications and all required material and documents, and to attend and represent me in my absence at all meetings and public hearings pertaining all City, County, State and Federal permits for completion of the project indicated above. Furthermore, upon consultation with me, I hereby give consent to the party designated above to agree to all terms and conditions which may arise as part of the approval of this Agent application for the proposed use of a 100,000 +/- sf self-storage / commercial development.

FURTHER AFFIANT SAYETH NOT.

The foregoing instrument was acknowledged before me this 29th day of June, 2021 by Phillip C. Hollis (Name of Person Acknowledging) who is personally known to me or who has produced _____ (type of identification) as identification and who ~~did~~ (did not) take an oath.

Carly Ervin
Notary Signature

Carly S. Ervin
Printed Name of Notary

Phillip C. Hollis
Owner's Agent Signature

**Phillip C. Hollis,
Flagship Companies Group, LLC
as Property's Owner's Agent**
Owner's Agent Name

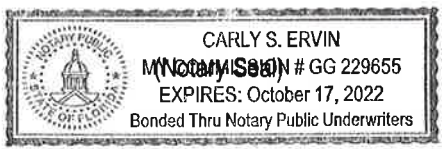

October 17, 2022
My commission expires

1190 Business Center Drive #2000
Street Address

Lake Mary, FL 32746
City, State, Zip

phillip@pmjs.com, 407-832-6444
Telephone / Email



Prepared by, record and return to:
Adrienne V. Schmitz, P.A.
12230 Forest Hill Blvd., Suite 102
Wellington, FL 33414

Tax Folio #: 2419-233-0001-000/5

[Space Above This Line For Recording Data]

Special Warranty Deed

This Special Warranty Deed made this 24th day of **May, 2006** between **JENKINS 70 PARTNERS, LLC, a Florida limited liability company**, whose post office address is 10505 S.W. 128th Terrace, Miami, FL 33176, grantor, and **NNN/1031 No. 16 SR 70 Jenkins LLC, a Florida limited liability company** whose post office address is 3399 PGA Blvd., Suite 450, Palm Beach Gardens, FL 33410, grantee:

(Whenever used herein the terms "grantor" and "grantee" include all the parties to this instrument and the heirs, legal representatives, and assigns of individuals, and the successors and assigns of corporations, trusts and trustees)

Witnesseth, that said grantor, for and in consideration of the sum of **TEN AND NO/100 DOLLARS (\$10.00)** and other good and valuable considerations to said grantor in hand paid by said grantee, the receipt whereof is hereby acknowledged, has granted, bargained, and sold to the said grantee, and grantee's heirs and assigns forever, the following described land, situate, lying and being in **St. Lucie County, Florida** to-wit:

See Exhibit "A" attached hereto and made a part hereof as if fully set forth herein.

Together with all the tenements, hereditaments and appurtenances thereto belonging or in anywise appertaining.

To Have and to Hold, the same in fee simple forever.

And the grantor hereby covenants with said grantee that the grantor is lawfully seized of said land in fee simple; that the grantor has good right and lawful authority to sell and convey said land; that the grantor hereby fully warrants the title to said land and will defend the same against the lawful claims of all persons claiming by, through, or under grantor, but none other; and that said land is free of all encumbrances, except taxes accruing subsequent to December 31, 2005, and that certain Annexation Agreement recorded in Official Records Book 943, Page 1496, public records of St. Lucie County, FL.

In Witness Whereof, grantor has hereunto set grantor's hand and seal the day and year first above written.

Signed, sealed and delivered in our presence:

[Signature]
 Witness Name: MARIA J. KIRSCHNER

[Signature]
 Witness Name: Olga L. Perez

GRANTOR:
JENKINS 70 PARTNERS, LLC, a Florida limited liability company

By: Mark Schwimmer
Mark Schwimmer, as Manager

State of Florida
County of Miami Dade

The foregoing instrument was acknowledged before me this 24th day of May, 2006 by Mark Schwimmer, as Manager of Jenkins 70 Partners, LLC, on behalf of said Company. He is personally known to me or [] has produced a driver's license as identification.

[Notary Seal]



[Signature]
Notary Public

Printed Name: Mary W. Kurlansik

My Commission Expires: _____

Exhibit "A"

(Jenkins 70 Partners LLC):

Begin at the Northeast corner of the Southwest 1/4 of the Southwest 1/4 of the Northwest 1/4 of Section 19, Township 35 South, Range 40 East, St. Lucie County, Florida and run South 00° 02' 33" East, a distance of 537.68 feet along the East line of the Southwest 1/4 of the Southwest 1/4 of the Northwest 1/4 of said Section 19, a distance of 537.68 feet to the Northerly Right-of-Way line of State Road 70;

thence run South 72° 44' 04" West along said Right-of-Way line a distance of 405.48 feet;

thence run North 01° 55' 27" East a distance of 195.18 feet;

thence run South 66° 42' 27" West a distance of 53.10 feet;

thence run North 00° 12' 27" East a distance of 265.00 feet;

thence run North 88° 47' 57" East, a distance of 1.00 feet;

thence run North 00° 12' 27" East a distance of 210 feet to the North line of aforesaid Southwest 1/4 of the Southwest 1/4 of the Northwest 1/4 of said Section 19;

thence run North 88° 47' 57" East a distance of 426.40 feet to the POINT OF BEGINNING.

TOGETHER WITH:

The South 95 feet of the North 380 feet of the East 194 feet of the West 234 feet of the Southwest 1/4 of the Southwest 1/4 of the Northwest 1/4 of Section 19, Township 35 South, Range 40 East; LESS Rights-of-Way for road and drainage canals; lying and being in St. Lucie County, Florida.

TOGETHER WITH:

South 75 feet of the North 285 feet of the East 194 feet of the West 234 feet of the Southwest 1/4 of the Southwest 1/4 of the Northwest 1/4 of Section 19, Township 35 South, Range 40 East; LESS and excepting there from all Rights-of-Way for public roads and drainage canals; lying and being in St. Lucie County, Florida.



Saint Lucie County Property Appraiser
 -Michelle Franklin CFA

Report generated: Thursday, April 8, 2021

Parcel Report

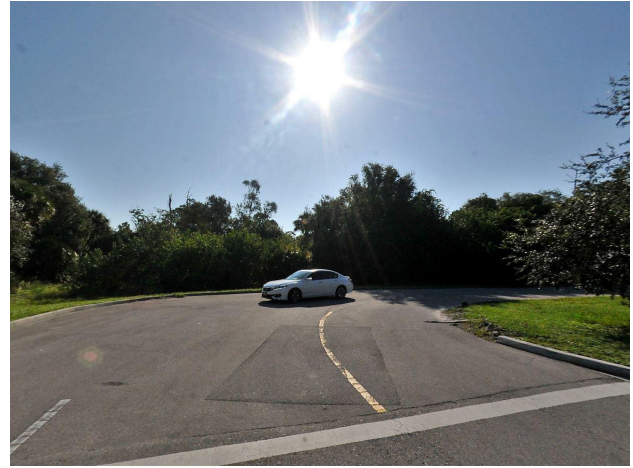

Parcel

PARCELNO: 2419-603-0003-000-4
Property ID: 175287
Owner1: NNN/1031 #16 Jenkins LLC
SiteAddress: JENKINS RD

Owner

Owner1: NNN/1031 #16 Jenkins LLC
Owner2:
Owner3:
MailingAddress: 2 Towne Sq Ste 900
 Southfield, MI 48076-3761

Overview

PrimaryLandUse: 1000 - Vac Comm
DistrictGroup: 0022 - Fort Pierce
Subdivision: Okeechobee Crossings
Just/Market Value: \$449,700
FinishedArea:
Acres: 3.226
TotalArea: 140,536

Legal Description

LegalDescription: OKEECHOBEE CROSSINGS-
 (PB 62-23) TRACT 3 LESS
 THAT PORTION FOR ROAD
 R/W AS IN OR 3629-89 (3.22
 AC - 140,536 SF)

Value History

Year	Just/Market Value	Building Value	Land Value	SFYI Value	Assessed Value	Exemption Amount	County Taxable	Save Our Home OR 10% Cap Differential	Ag Credi
2020	\$449,700	\$0	\$449,700	\$0	\$449,700	\$0	\$449,700	\$0	\$0
2019	\$449,700	\$0	\$449,700	\$0	\$449,700	\$0	\$449,700	\$0	\$0
2018	\$449,700	\$0	\$449,700	\$0	\$449,700	\$0	\$449,700	\$0	\$0

Tax Links

- [SLC Tax Collector's Office taxes for this parcel](#)
- [Download TRIM notice for this parcel](#)

Special Assessments

Description	Start Year	Units	Amount
North St. Lucie Water Management District	2014	3.22	\$59.57
Fort Pierce Stormwater Charge	2010	8.8	\$607.20

Improvements

Building	1
Sequence:	
Bedrooms:	0
Bathrooms:	0
Building Type:	-
Story Height:	
No of Living Units:	
Total Finished Area:	0
Gross Sketched Area:	0
Year Built:	
Effective Year:	
Primary Roof Cover:	
Primary Roof Structure:	
Primary Wall:	
A/C %:	0

Land Lines

Line Number	Units	Unit Type
1	140,536	SqFt

Sales History

Sale Date	Sale Price	Sale Code	Deed Type	Grantor	Book Page	View Document
05/24/2006	\$2,800,000	XX02	SP	Jenkins 70 Partners LLC	2582-2467	Clerk of Courts

Photos

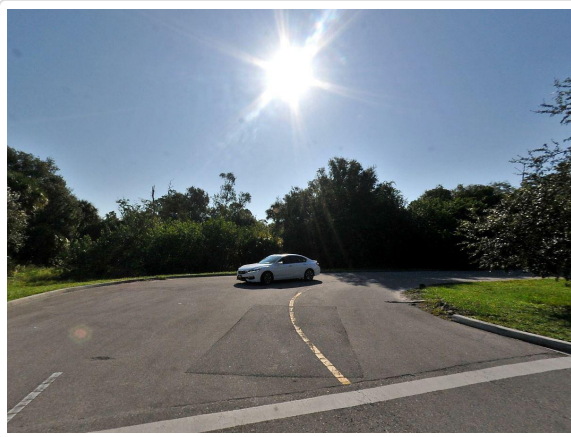



Saint Lucie County Property Appraiser
 -Michelle Franklin CFA

Report generated: Thursday, April 8, 2021

Progress bar
 Your report is loading.

Parcel Report



Parcel

PARCELNO: 2419-603-0004-000-1
Property ID: 175288
Owner1: NNN/1031 #16 Jenkins LLC
SiteAddress: JENKINS RD

Owner

Owner1: NNN/1031 #16 Jenkins LLC
Owner2:
Owner3:
MailingAddress: 2 Towne Sq Ste 900
 Southfield, MI 48076-3761

Overview

PrimaryLandUse: 1000 - Vac Comm
DistrictGroup: 0022 - Fort Pierce
Subdivision: Okeechobee Crossings
Just/Market Value: \$209,100
FinishedArea:
Acres: 1.5
TotalArea: 65,340

Legal Description

LegalDescription: OKEECHOBEE
 CROSSINGS-(PB 62-23)
 TRACT 4 (1.50 AC - 65,340
 SF)

Value History

Year	Just/Market Value	Building Value	Land Value	SFYI Value	Assessed Value	Exemption Amount	County Taxable	Save Our Home OR 10% Cap Differential	Ag Credi
2020	\$209,100	\$0	\$209,100	\$0	\$209,100	\$0	\$209,100	\$0	\$0
2019	\$209,100	\$0	\$209,100	\$0	\$209,100	\$0	\$209,100	\$0	\$0
2018	\$209,100	\$0	\$209,100	\$0	\$209,100	\$0	\$209,100	\$0	\$0

Tax Links

- [SLC Tax Collector's Office taxes for this parcel](#)
- [Download TRIM notice for this parcel](#)

Special Assessments

Description	Start Year	Units	Amount
North St. Lucie Water Management District	2013	1.5	\$27.75
Fort Pierce Stormwater Charge	2010	4.1	\$282.90

Improvements

Building	1
Sequence:	
Bedrooms:	0
Bathrooms:	0
Building Type:	-
Story Height:	
No of Living Units:	
Total Finished	0
Area:	
Gross Sketched	0
Area:	
Year Built:	
Effective Year:	
Primary Roof	
Cover:	
Primary Roof	
Structure:	
Primary Wall:	
A/C %:	0

AGREEMENT FOR SALE AND PURCHASE OF PROPERTY

NNN/1031 NO. 16 SR 70 Jenkins LLC / Flagship Companies Group, LLC
Jenkins Road, Fort Pierce, FL 34947 – 3.23 developable acres (Tract 3) and 1.50
nondevelopable acres (Tract 4 – Retention Area) – St. Lucie County, Florida.
Folio Nos.: 2419-603-0003-000-4; 2419-603-0004-000-1

THIS AGREEMENT FOR SALE AND PURCHASE OF PROPERTY ("Agreement") is made this 8th day of [REDACTED] NNN/1031 NO. 16 SR 70 Jenkins LLC the "Seller"), and Flagship Companies Group, LLC, or its assigns (the "Purchaser").

RECITALS

WHEREAS, Seller is the Owner of those certain parcels of real property situated at Jenkins Road, Fort Pierce, FL 34947 – 3.23 developable acres (Tract 3) and 1.50 nondevelopable acres (Tract 4 – Retention Area) – St. Lucie County, Florida; Folio Nos. 2419-603-0003-000-4 and 2419-603-0004-000-1 and more particularly described on Exhibit "A", hereto (together with all improvements and the other appurtenant rights thereto as described below, the "Property");

WHEREAS, the Purchaser desires to purchase, and Seller is willing to sell, the Property on the terms and conditions set forth herein;

NOW, THEREFORE, for ten dollars (\$10.00) and other good and valuable consideration, the receipt and sufficiency of which are hereby acknowledged, the parties agree as follows:

1. AGREEMENT TO SELL; PURCHASE PRICE

1.1 Agreement to Sell and Convey Property. Subject only to the conditions set forth in Section 5, below, Seller hereby agrees to sell and convey the Property to Purchaser, and Purchaser hereby agrees to purchase the Property from Seller. The Property to be conveyed hereunder shall include any and all buildings, infrastructure, utilities and other fixtures presently situated on the Property, all zoning entitlements, approvals, and permits related to the Property, and all easements, rights-of-way, or other appurtenances to the Property (specifically excluding therefrom any impact fee credits).

1.2 Purchase Price. The purchase price ("Purchase Price") to be paid for the Property shall be [REDACTED]. The Purchase Price shall be paid by Purchaser to Seller at Closing after credit for the Deposit (defined below) by federal wire transfer payable to the Purchaser's designated Escrow Agent (defined below) for the Closing.

1.3 Earnest Money Deposit. Within three (3) business days after the Effective Date (defined below) of this Agreement, Purchaser shall provide a [REDACTED] Dollar [REDACTED] earnest money deposit (the "Initial Deposit") to Kramer, Sopko and Copeland P.A., Trust Account, 411 SE Osceola Street, Suite 200, Stuart, FL 34994 ("Escrow Agent"). The Initial Deposit shall be fully refundable to Purchaser during the Inspection Period (defined below); however, if Purchaser does not terminate this Agreement prior to the expiration of the Inspection

Period, the Purchaser shall then provide an additional [REDACTED] deposit (the "Additional Deposit") to the Escrow Agent prior to the expiration of the Inspection Period (the Initial Deposit and the Additional Deposit totaling [REDACTED] are hereafter referred to as the "Deposit"). The Deposit then shall become non-refundable to Purchaser, except only for Seller's default, failure of Seller to convey title in accordance with Sections 2.1 and 2.2 and Purchaser's failure to get conditional use and site-plan approval for a 100,000+ square foot self-storage facility from the Town of Fort Pierce. The Deposit shall be applied to the Purchase Price at Closing.

2. SURVEY AND TITLE COMMITMENT; PERMITTED EXCEPTIONS

2.1 Title Commitment & Policy; Title Objections. Promptly after the Effective Date, Purchaser shall order a title search and title insurance commitment (the "Title Commitment") to issue and deliver to Purchaser at Closing an ALTA owner's title policy for the Property (the "Title Policy") and naming Purchaser as insured, with coverage in the amount of the Purchase Price for the Property from a nationally recognized title company selected by Purchaser to issue such Title Policy (the "Title Company"). Within sixty (60) days after the Effective Date, Purchaser shall give Seller written notice as to any conditions of title to which Purchaser objects that affect Purchaser's proposed use of the Property, as determined in the sole discretion of Purchaser ("Title Defects"). If Purchaser timely delivers the Title Defects notice to Seller, Seller shall notify Purchaser (the "Title Response") within seven (7) days after Seller's receipt of the Title Defects whether or not Seller (in its sole discretion) will attempt to cure any such Title Defect. If Seller fails to satisfy (or commit to satisfy) any such Title Defects or if Seller is unable or unwilling to cure any such Title Defects, then at the option of Purchaser, exercised by written notice to Seller within three (3) business days after receipt of Seller's notice, (i) this Agreement shall be null and void, and the Deposit shall be promptly returned to Purchaser, or (ii) Purchaser shall waive such Title Defects (which, together with those matters of title and survey to which Purchaser has not objected, shall thereafter become "Permitted Exceptions") and proceed to Closing without reduction in the Purchase Price. If Purchaser fails to timely deliver its written notice to Seller of its election of either (i) or (ii) in this Section 2.1, Purchaser shall be deemed to have elected (ii) in this Section 2.1. If the Title Response provides that Seller will attempt to cure any such Title Defects, then Seller will proceed to use good faith efforts to cure such Title Defects prior to Closing and will take such actions as are reasonably required; provided, however, Seller shall not be obligated to institute any litigation, including, without limitation, the payment of money with respect thereto, to cure such Title Defects. If five (5) business days prior to the Closing Date, Seller provides written notice to Purchaser of its failure to cure any Title Defects which Seller has agreed to attempt to cure, then Purchaser shall have the option, to be exercised in writing within three (3) business days after Purchaser's receipt of such written notice from Seller of either exercising (i) or (ii) in this Section 2.1. If Purchaser fails to timely deliver its written notice to Seller of its election of either (i) or (ii) in this Section 2.1, Purchaser shall be deemed to have elected (ii) in this Section 2.1. Seller agrees not to hereafter record any documents which may affect title to the Property without Purchaser's prior written consent, which consent shall not be unreasonably withheld, conditioned or delayed, and to procure the satisfaction, vacation or release of any mortgage liens upon the Property concurrent with Closing.

2.2 Survey; Objections; Deletion of Survey Exception. Seller shall provide any pre-existing survey for the Property to Purchaser within five (5) business days after the Effective Date of this Agreement. Purchaser at its election may either procure an updated, re-certified survey

of the Property, or a new certified survey. Any objection by Purchaser to any matter of survey shall be treated in the same manner as a Title Defect with the same objection and response timeline to apply, pursuant to Section 2.1, above.

3. PROVISIONS WITH RESPECT TO CLOSING

3.1 Closing Date; Potential Extension. The consummation of the transaction contemplated by this Agreement ("Closing") shall take place at the Escrow Agent's office or via a "mail away" closing (wherein executed documents shall be delivered to the Title Company via overnight delivery and the funds due from or on behalf of the Purchaser to effectuate the Closing are delivered to Seller via wire transfer no later than 2:00 p.m. Eastern Daylight Savings Time on the Closing Date), within One Hundred and Eighty (180) days after expiration of Purchaser's Inspection Period pursuant to Section 5.1. below; provided, however, that Purchaser may extend the Closing for three (3) additional thirty (30) day periods by providing notice to Seller not later than five (5) days prior to the above Closing Date or Extended Closing Date, in which event Purchaser shall provide an additional [REDACTED] earnest money deposit (the "Extension Deposit") to the Escrow Agent for each extension, for a total Deposit amount of [REDACTED] or respectively [REDACTED] to be applied to the Purchase Price at closing of the transaction.

3.2 Seller's Obligation at Closing. At Closing, Seller shall do the following:

(a) Execute, acknowledge, and deliver to Purchaser a Special Warranty Deed in form approved by the Title Company ("Deed") conveying fee simple title to the Property to Purchaser, subject only to the Permitted Exceptions. The legal description of the Property contained in the Deed shall be identical to the legal description of the Property as contained in the Survey and the Title Commitment (any discrepancy between the survey legal and title commitment legal shall be resolved and conformed by the Title Company and the surveyor); and

(b) Deliver to Title Company evidence satisfactory to it of Seller's authority to execute and deliver the documents necessary or advisable to consummate the transaction contemplated hereby; and

(c) Execute and deliver to Purchaser and Title Company an affidavit of no liens from the Seller satisfactory to Title Company as to cause Title Company to remove the mechanic's lien and parties in possession standard exceptions from the Title Commitment; and

(d) Execute and delivery to Title Company a certification duly executed by Seller ("FIRPTA Certificate") setting forth Owner's address and federal tax identification number and certifying that Owner is a "United States Person" and that Owner is not a "foreign person" in accordance with and/or for the purpose of the provisions of Section 7701 and 1445 (as may be amended) of the Internal Revenue Code of 1986, as amended, and any regulations promulgated thereunder; and

(e) Execute and delivery to the Title Company a Form 1099-S and any other tax information forms typically required for such real estate transactions; and

(f) Execute and deliver to Title Company and Purchaser the approved Closing Statement.

(g) Execute and deliver to Purchaser a Quit Claim Bill of Sale & General Assignment of all tangible personal property and intangible personal property rights that are appurtenant to the Property, as provided for in Section 1.1, above.

All documents shall be subject to the review and approval of the Title Company.

3.3 Purchaser's Obligations at Closing. Subject to the terms, conditions and provisions hereof and contemporaneously with the performance by Seller of its obligations set forth above, Purchaser shall deliver to Escrow Agent at Closing the following:

(a) Federal wire transfer in the amount of cash required to close pursuant to Paragraph 1.2 hereof, after credit for the Deposit; and

(b) A direction to the Escrow Agent to disburse the Deposit to the Title Company to be applied as provided in this Agreement and as a credit in favor of the Purchaser against the Purchase Price; and

(c) Execute and deliver to Seller and Title Company the approved Closing Statement; and

(d) Execute and deliver to the Title Company any other authorization documents required by it for the Closing; and

(e) Execute and deliver to a counterpart of the Quit Claim Bill of Sale & General Assignment of all tangible personal property and intangible personal property rights that are appurtenant to the Property, as provided for in Section 1.1, above.

3.4 Closing Costs.

(a) Seller shall pay the following costs and expenses in connection with the Closing:

- (i) The applicable documentary stamp/transfer taxes on the Deed;
- (ii) The costs of recording curative title documents, if any;
- (iii) Seller's attorney fees relating to the sale of the Property; and
- (iv) Seller's brokerage commissions payable to Broker incurred in connection with the sale of the Property to Purchaser, if and when the Closing occurs.

(b) Purchaser shall pay the following closing costs and expenses in connection with the Closing:

- (i) Recording fees for the Deed;
- (ii) The cost of the premium payable to the Title Company) for the Title Insurance Commitment and the owner's title insurance policy (collectively, the "Owner's Title Insurance");

- (iii) The cost of (i) endorsements requested by Purchaser to the Owner's Title Insurance, and (ii) insuring the mortgage of any lender of Purchaser and any searches and endorsements required by Purchaser's lender;
- (iv) Survey costs;
- (v) Escrow fees;
- (vi) All costs related to Purchaser's due diligence work and any financing (if procured by Purchaser); and
- (vii) Purchaser's attorney fees.

3.5 Proration of Taxes, Assessments. Ad valorem taxes, special assessments, and any certified assessments for the year of the Closing shall be prorated to the date of Closing with due allowance for the maximum discount rate allowable, based upon the most recent tax bill(s) for the Property. Such prorations shall be final.

4. NO REPRESENTATIONS AND WARRANTIES WITH RESPECT TO PROPERTY; "AS IS" PURCHASE.

4.1 AS-IS Purchase. Purchaser acknowledges that Seller has not made any representations or warranties whatsoever with respect to the Property. Purchaser will be responsible for its own due diligence and investigation with respect to the Property, and the purchase of the Property shall be "As-Is" with no representation or warranty from Seller, whatsoever.

5. CONDITIONS TO CLOSING

The Closing is conditional only upon the following matters:

5.1 Purchaser's Inspection Period. Purchaser shall have a period of [REDACTED] days after the Effective Date of this Agreement to conduct its due diligence with respect to the Property (the "Inspection Period"). In connection therewith, the Seller agrees to provide copies of the following documents related to the Property, to the extent they are in the possession of Seller, within five (5) business days after the Effective Date of this Agreement:

- (i) Copies of all governmental permits, inspection reports, governmental approvals and certificates of occupancy;
- (ii) Copies of all third-party reports including environmental assessments, geotechnical studies or reports;
- (iii) Schedule of all personal property to be conveyed pursuant to Section 1.1, above;
- (iv) Seller's title policy and existing survey;
- (v) All association documents; and
- (vi) Any other documents pertaining to the Property that affect its title to the Property, restrictions or encumbrances, zoning use or operation.

The Inspection Period shall be extended by one (1) day for each day beyond the five (5) business

days that is required for Seller to provide the foregoing documents to Purchaser. Purchaser shall have full right of access to and from the Property during all business hours from the Effective Date, through Closing, to perform its due diligence investigation, including any environmental, soils tests or other third-party tests desired by Purchaser ("Due Diligence Materials").

Notwithstanding the foregoing, no Phase II environmental testing or sampling or any other invasive or intrusive testing or sampling may be performed without Seller's prior written consent, which consent Seller agrees not to unreasonably withhold provided Seller has first received a detailed description of the contemplated scope of work. Purchaser will give Seller forty-eight (48) hours advance notice of its (and any of its consultants) entry onto the Property by prior notification

Purchaser hereby agrees to indemnify and hold Seller harmless from any damages, liabilities or claims for property damage or personal injury and mechanics liens solely caused by or exclusively arising from Purchaser and/or Purchaser's consultants in the conduct of such inspections and investigations. Purchaser shall also repair (or cause to be repaired) any damage to the Property (or any portion thereof) promptly and restore the Property to substantially the same condition as prior to such damage, at Purchaser's sole expense. Purchaser's obligations of repair, restoration and indemnity shall survive the Closing or early termination hereof. Seller shall reasonably cooperate with and assist Purchaser in making such inspections.



Purchaser shall notify Seller prior to expiration of the Inspection Period whether the Property is acceptable to Purchaser and suitable for Purchaser's use, in its sole and absolute discretion. If Purchaser does not notify Seller that Purchaser has accepted the Property and intends to proceed under this Agreement prior to expiration of the Inspection Period, then this Agreement shall be deemed to have automatically terminated, and the Deposit shall be returned by Escrow Agent to the Purchaser, without any further authorization or direction required from Seller. Should the contract be terminated by Purchaser, Purchaser will provide to Seller all Due Diligence Materials, including any and all plans and third party reports.



5.2 Title & Survey. Seller must provide fee simple title to the Property at Closing, subject only to the Permitted Exceptions and otherwise in accordance with the terms of Sections 2.1 and 2.2, above.

6. PROVISIONS WITH RESPECT TO DEFAULT

6.1 Default by Seller. In the event that Seller should be in breach or default of any of its obligations under this Agreement; Purchaser shall have the right to (i) enforce specific performance of this Agreement filed within sixty (60) days after the alleged default, or (ii) terminate this Agreement and receive the return of the Deposit, in which event the parties shall be relieved of any further obligations hereunder, which shall be the sole and exclusive remedies available to Purchaser hereunder.

6.2 Default by Purchaser. In the event that Purchaser should fail to consummate the transaction contemplated herein for any reason, except (i) default by Seller, (ii) the failure to deliver title as required by this Agreement, (iii) or the failure of any condition to Purchaser's required performance under this Agreement, then the Deposit paid hereunder shall be and become the property of the Seller, such sums being agreed upon as liquidated damages for the failure of Purchaser to perform the duties and obligations imposed upon it by the terms and provisions of this Agreement and because of the difficulty, inconvenience and uncertainty of ascertaining actual damages. Seller agrees to accept and take such Deposit as Seller's total damages and relief, and sole and exclusive remedy hereunder.

7. OTHER CONTRACTUAL PROVISIONS

7.1 Binding Effect; Assignment. This Agreement shall be binding upon and shall inure to the benefit of the parties hereto and their successors and assigns; provided, however, that any assignment by Purchaser must occur to an entity of which Purchaser or its principals have a majority and controlling equitable or beneficial interest. Notwithstanding such assignment, Purchaser shall continue to be liable under this Agreement until Closing. Any other assignment of this Agreement by Purchaser shall be ineffective without the prior written consent of Seller, which consent shall be within Seller's sole discretion. Upon any permitted assignment of this Agreement, the assignee shall assume in writing all obligations of Purchaser under this Agreement, and shall agree to execute all necessary documents which Purchaser is obligated to execute pursuant to the terms and provisions of this Agreement, and Seller shall have received a copy of such assignment not later than five (5) business days prior to the Closing Date.

7.2 Not later than ten (10) days prior to Closing, and Purchaser shall provide Escrow Agent and Title Company with the legal name, organizational documents, and other required authorizing resolutions for such new Purchaser entity at the time of such of the permitted assignment by Purchaser in accordance with Section 7.1 above, for preparation of the Title Commitment and Closing documents.

7.3 Escrow. The payment of the Deposit and all other funds provided hereunder and the delivery of all documents to the Escrow Agent is for the accommodation of the parties to this Agreement. The duties of the Escrow Agent shall be determined solely by the

express provisions of this Agreement. In the event Escrow Agent receives a written demand from either Seller or Purchaser for the Deposit or documents (which demand shall include an explanation setting forth the factual basis for such party's request for the Deposit or documents), Escrow Agent shall give three (3) business days' written notice to the other party of such demand and of Escrow Agent's intention to remit the Deposit or deliver the documents to the party making the demand on the stated date. If Escrow Agent does not receive a written objection within three (3) business days after such notice, Escrow Agent is hereby authorized to so remit the Deposit or deliver the documents. If, however, Escrow Agent actually receives written objection from the other party within three (3) business days after such notice, Escrow Agent shall continue to hold the Deposit or the documents until otherwise directed by joint written instructions from Seller and Purchaser, or until a final judgment of an appropriate court is issued. Purchaser and Seller authorize Escrow Agent, without creating any obligation on the part of Escrow Agent, in the event this Agreement, the Deposit or the documents become involved in litigation, to deposit the Deposit or the documents with the clerk of the court in which the litigation is pending and thereupon Escrow Agent shall be fully relieved and discharged of any further responsibility under this Agreement. The undersigned also authorize Escrow Agent, if it is threatened with litigation, to interplead all interested parties in any court of competent jurisdiction and to deposit the Deposit or the documents with the clerk of the court and thereupon Escrow Agent shall be fully relieved and discharged of any further responsibility hereunder. Escrow Agent shall not be liable for any mistake of fact or error of judgment or any acts or omissions of any kind unless caused by its own willful misconduct or gross negligence. Escrow Agent shall be entitled to rely on any instrument or signature believed by it to be genuine and may assume that any person purporting to give any writing, notice or instruction in connection with this Agreement is duly authorized to do so by the party on whose behalf such writing, notice, or instruction is given. Purchaser and Seller shall, and hereby agree to jointly and severally indemnify Escrow Agent for and hold it harmless against any loss, liability, or expense including reasonable attorneys' fees incurred on the part of Escrow Agent arising out of or in connection with the acceptance of, or the performance of its duties under, this Agreement, as well as the costs and expenses of defending against any claim or liability arising under this Agreement. Purchaser acknowledges that Escrow Agent is also acting as the Seller's attorney in this transaction, and irrevocably waives any conflict of interest related thereto. This provision shall survive the Closing or earlier termination of this Agreement.

7.4 Broker Commissions. Purchaser and Seller each represents and warrant to



7.5 Entire Agreement, Modification. This Agreement embodies and constitutes the entire understanding between the parties with respect to the transaction contemplated herein. All prior or contemporaneous agreements, understandings, representations, and statements, oral or written, are merged into this Agreement. Neither this Agreement nor any provision hereof may be waived, modified, amended, discharged, or terminated except by an instrument in writing signed by the party against which the enforcement of such waiver, modification, amendment, discharge or termination is sought, and then only to the extent set forth in such instrument.

7.6 Effective Date; Time. The Effective Date of this Agreement shall be the date it is last signed by Seller or Purchaser, as indicated below. Time is of the essence of this Agreement.

7.7 Counterparts. This Agreement may be executed in several counterparts, each constituting a duplicate original but all such counterparts constituting one and the same Agreement. Electronic or facsimile signatures shall constitute original signatures under this Agreement.

7.8 Exhibits. All exhibits attached hereto are hereby incorporated herein by this reference.

7.9 Possession. Possession of the Property shall be delivered to Purchaser immediately upon Closing.

7.10 Enforcement. In the event of any litigation related to this Agreement, exclusive jurisdiction and venue shall lie in St. Lucie County, Florida, where the property is located. In any such proceedings, the prevailing party shall recover reasonable attorney's fees and all costs, including expert witness fees, paralegal fees, and any of such fees or costs incurred on any appeal. This provision shall survive early termination or Closing of this transaction.

7.11 Notices. Any notice required or authorized under this Agreement shall be sent by overnight mail or by electronic mail, addressed as follows, and shall be deemed effective as of the date of receipt thereof by the party to whom it is addressed:



7.12 Cooperation: Seller agrees to cooperate with Purchaser in order for Purchaser to obtain a conditional use and site plan approval for 100,000+ square foot self-storage facility.

7.13 Confidentiality. All information furnished to the parties under this Agreement shall be treated as confidential and the parties shall take normal and reasonable precautions to preserve the

confidentiality of this information until Closing or the termination of this Agreement (as the case may be). If this Agreement is terminated, the parties shall return all documents and other materials containing, reflecting and referring to such information and shall take normal and reasonable precautions to preserve the confidentiality of this information. The parties' obligations under this Agreement shall not apply to any information which: (i) was already in its possession prior to the disclosure thereof by the disclosing party, (ii) was then generally known to the public, (iii) became known to the public through no fault of the receiving party or any of its agents or representatives, or (iv) was disclosed to a party to this Agreement by a third party unaffiliated with any party to this Agreement who was not bound by an obligation of confidentiality. The obligations hereunder shall survive the early termination of this Agreement.

7.14 JURY WAIVER. IN ANY CIVIL ACTION, COUNTERCLAIM, OR PROCEEDING, WHETHER AT LAW OR IN EQUITY, WHICH ARISES OUT OF, CONCERNS, OR RELATES TO THIS AGREEMENT, ANY AND ALL TRANSACTIONS CONTEMPLATED BY THIS AGREEMENT, THE PERFORMANCE OF THIS AGREEMENT, OR THE RELATIONSHIP CREATED BY THIS AGREEMENT, WHETHER SOUNDING IN CONTRACT, TORT, STRICT LIABILITY, OR OTHERWISE, TRIAL SHALL BE TO A COURT OF COMPETENT JURISDICTION AND NOT TO A JURY. EACH PARTY HEREBY IRREVOCABLY WAIVES ANY RIGHT IT MAY HAVE TO A TRIAL BY JURY. ANY PARTY MAY FILE AN ORIGINAL COUNTERPART OR A COPY OF THIS AGREEMENT WITH ANY COURT, AS WRITTEN EVIDENCE OF THE CONSENT OF THE PARTIES TO THIS AGREEMENT OF THE WAIVER OF THEIR RIGHT TO TRIAL BY JURY. NEITHER PARTY HAS MADE OR RELIED UPON ANY ORAL REPRESENTATIONS TO OR BY ANY OTHER PARTY REGARDING THE ENFORCEABILITY OF THIS PROVISION. EACH PARTY HAS READ AND UNDERSTANDS THE EFFECT OF THIS JURY WAIVER PROVISION. EACH PARTY ACKNOWLEDGES THAT IT HAS BEEN ADVISED BY ITS OWN COUNSEL WITH RESPECT TO THE TRANSACTION GOVERNED BY THIS AGREEMENT AND SPECIFICALLY WITH RESPECT TO THE TERMS OF THIS SECTION.

7.15 Patriot Act Compliance. Each party hereto acknowledges that it is (i) not, and will not be, a person or entity that is restricted from doing business under the Uniting and Strengthening America by Providing Appropriate Tools Required to Intercept and Obstruct Terrorism Act of 2001, H.R. 3162, Public Law 107-56 (commonly known as the "USA Patriot Act") and Executive Order Number 13224 on Terrorism Financing, effective September 24, 2001 and regulations promulgated pursuant thereto (collectively, "Anti-Terrorism Laws"), including without limitation persons and entities named on the Office of Foreign Asset Control ("OFAC") Specially Designated Nationals and Blocked Persons List, and (ii) currently in compliance with and at all times during the term of this Agreement shall be in compliance with the USA Patriot Act, the Anti-Terrorism Laws and all regulations or other governmental action relating thereto.

[NO FURTHER TEXT; SIGNATURE PAGES FOLLOW]

IN WITNESS WHEREOF, the parties hereto have executed this Agreement as of the dates specified below.

SELLER: NNN/1031 NO. 16 SR 70 Jenkins LLC
a Florida limited liability company

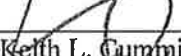
By: 
Keith L. Cummings, Manager

Date: 4/8/2021

PURCHASER: Flagship Companies Group, LLC

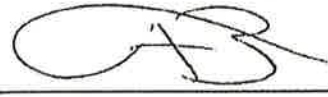
By: 

Ted Bolin
Title: CEO

Date: April 6, 2021

The Escrow Agent does hereby accept the duties of Escrow Agent as set forth in this Agreement, subject to receipt of the Deposit under the Agreement, and subject to clearance of funds.

ESCROW AGENT:

Kramer, Sopko and Copeland, P.A.

By:  Pres
Robert Kramer, Esquire

Date: 4/8/21

“Exhibit A”

Tracts 3 and 4 of Okeechobee Crossings, according to the Plat thereof recorded in Plat Book 62, Pages 23 and 24, of the Public Records of St. Lucie County, Florida.

manufacturing uses; however, any Tract may be used for any warehouse, office and so-called "flex" warehouse/office uses), any mining or mineral exploration or development except by non-surface means, a car wash, a carnival, amusement park or circus, an assembly hall, off track betting establishment, any use involving the use, storage, disposal or handling on of hazardous materials or underground storage tanks, any use which may require water and sewer services in excess of the capacities allocated to the Development by any governmental authority, a church, temple, synagogue, mosque, or other house of worship, any facility for the sale of paraphernalia for use with illicit drugs or any use which legally constitutes a nuisance under applicable codes, laws or ordinances.

4. **MAINTENANCE AND TAXES.**

Each Owner shall be responsible for Maintenance (as defined below), at its own cost, of its respective Tract in accordance with Laws and otherwise in a good, clean and sanitary order, free from infestation from insects, rodents, vermin and other pests and otherwise in a condition comparable to other substantially similar retail/commercial/office/warehouse/flex properties located in St. Lucie County, Florida. "Maintenance" includes (but is not limited to) sweeping, washing and removal of trash, litter and refuse, removal of snow and ice from pavement, parking areas and walkways, painting and striping of parking areas, repair and replacement of paving as necessary (including any portions of the Access Easement Area located within each Owner's Tract), repair and replacement of utilities and drainage exclusively serving such Tract, maintenance of landscaped areas (including replacement and replanting), and maintenance and repair of lighting, fixtures, signage, directional signs, lines and markers. Paved areas shall be maintained in a level, smooth and evenly-covered condition with the type of surfacing material originally installed or such substitute as shall be comparable in quality, use, and durability. Garbage, trash, rubbish and other refuse, will be stored in covered containers or compactors and removed at regular intervals, not less than weekly, at such Owner's expense.

The Owner of Tract 4, shall charge each of the other Owners its prorata share of all of the costs of owning, operating, repairing, replacing, monitoring, compliance with all applicable governmental requirements, permits, approvals, and maintaining the Drainage Pond and any associated Drainage Facilities, together with a reasonable management fee for all of the foregoing, and any reasonable attorneys fees associated therewith ("Drainage Fee"), to be charged by the Tract 4 Owner no less frequently than annually and paid by the other Tract Owners within no more than thirty (30) days from the date of receipt of any charge therefor, or may enter into a management contract with a management company to accomplish the foregoing without the consent of any of the other Tract Owners. "Prorata share" shall be deemed to mean the proportion of each Tract's total gross land square footage to the total gross land square footage of the Development, excluding Tract 4. Notwithstanding the foregoing, the Tract 1 acreage is approximately 1.72 acres, the Tract 2 acreage is approximately 1.81 acres, and the Tract 3 acreage is approximately 3.24 acres. Failure by any Owner to pay the Drainage Fee to the Tract 4 Owner within said 30-day period shall constitute a default by said Owner hereunder, entitling the Tract 4 Owner to all of the enforcement rights and remedies set forth in Section 10 hereinbelow. The Owners further acknowledge that such notice shall constitute sufficient notice as required under Section 15 herein to allow the Tract 4 Owner to avail itself of the rights, remedies and self help allowed under Section 10 herein for any Owner's failure to pay its prorata share within said thirty (30) day period, without further notice or demand by the Tract 4 Owner.

Notwithstanding the foregoing, however, the Owners agree that at any time the Tract 4 Owner may elect, without the consent of any of the other Owners, to convey the ownership of Tract 4, and the ownership of the Drainage Facilities, to a not-for profit property owner's association, to be formed at the cost of all of the Owners, and thereafter the reasonable costs of Maintenance, owning and operating Tract 4 and the Drainage Facilities, including without limitation, all of the reasonable costs of ownership, maintenance and monitoring, ad valorem taxes, liability insurance, and any governmental permits, approvals or other requirements by law of the Drainage Easement Area and Drainage Facilities located therein, or associated therewith, as defined in Sections 1.C. and 1.D. hereinabove ("Overall Drainage Maintenance and Operation"), shall be the sole responsibility of the not-for-profit property owner's association, to be formed by the Tract 4 Owner, which will own Tract 4 and the Drainage Facilities ("POA Association"), who shall perform such Overall Drainage Maintenance and Operation directly or may elect, in its reasonable discretion to employ maintenance or management persons or companies to perform same at a reasonable cost, and shall charge the Drainage Fee to all of the Owners as the Tract 4 Owner had done previously. The POA Association shall thereafter perform the Overall Maintenance and Operation and shall assess each Tract its prorata share of the Drainage Fee no less than annually by written notice and each Owner shall promptly remit its prorata share to the POA Association but in no event later than thirty (30) days from the date of receipt of same. The Owners further acknowledge that such notice shall constitute sufficient notice as required under Section 10 herein to allow the POA Association to avail itself of the rights, remedies and self help allowed in Section 10 for any Tract Owner's failure to pay its prorata share within said thirty (30) day period, without further notice or demand by the POA Association.

5. **CONSTRUCTION ACTIVITIES.**

Construction activities performed on the Development, or any portions thereof:

(a) shall be performed in a good and workmanlike manner so as not to unreasonably disturb the operation of any business conducted upon any Tract, or interfere with the Owner or Permitted Users of any Owner, and once commenced, such work will be diligently pursued to completion; and

(b) any grading which materially alters the flow of surface water or materially modifies the grading or drainage of the Access Easement Area or an adjoining Tract (as currently constructed) shall be repaired and restored as nearly as practicable to its prior existing condition in a prompt and workmanlike manner; and

(c) once constructed, the Access Easement Area or any portion thereof shall not be materially obstructed during the normal business hours of any Owner except as may be reasonably necessary to perform maintenance, repair and replacement or as may be reasonably necessary to prevent the dedication of the Access Easement Area to public use; and

(d) any construction on any Tract shall not in any way adversely affect the drainage, water storage, storm water retention and run off discharge to any other Tract. If the development of any of the Tracts in any way changes, alters or affects the current or any future rights or uses of the Development's stormwater retention, storage, drainage or discharge pursuant to that certain site plan approval for the Development to be obtained



Flagship Storage - Jenkins & Okeechobee

Location Map

City of Fort Pierce



NORTH



ENGINEERS SURVEYORS ENVIRONMENTAL

BOUNDARY & TOPOGRAPHIC SURVEY FOR: FLAGSHIP STORAGE

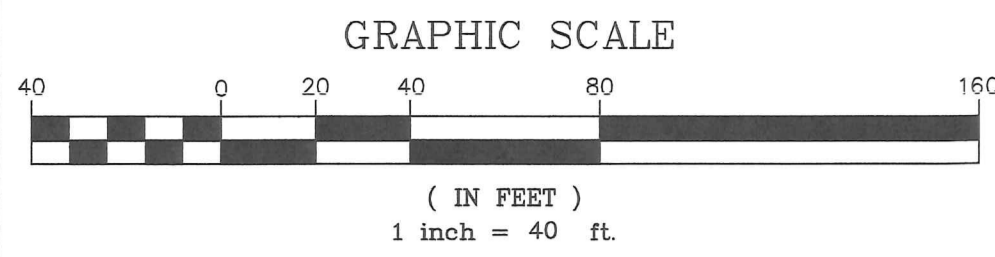

SITE
ST. LUCIE COUNTY, FLORIDA
VICINITY MAP
NO SCALE

EDC
ENGINEERS & SURVEYORS
ENVIRONMENTAL
10250 VILLAGE PARKWAY
UNIT 201
PORT ST. LUCIE, FL 34987
772-462-2455
www.edc-inc.com

F.P.E. CERTIFICATE OF AUTHORIZATION #595
L.S. CERTIFICATE OF AUTHORIZATION #098

LS	DATE
DRAWN BY	
MTO	
CHECKED BY	
IP	
FIELD CREW	
21-201	
FILENAME	
LAYOUT	
AS SHOWN	
SCALE	
Map 24, 2021	

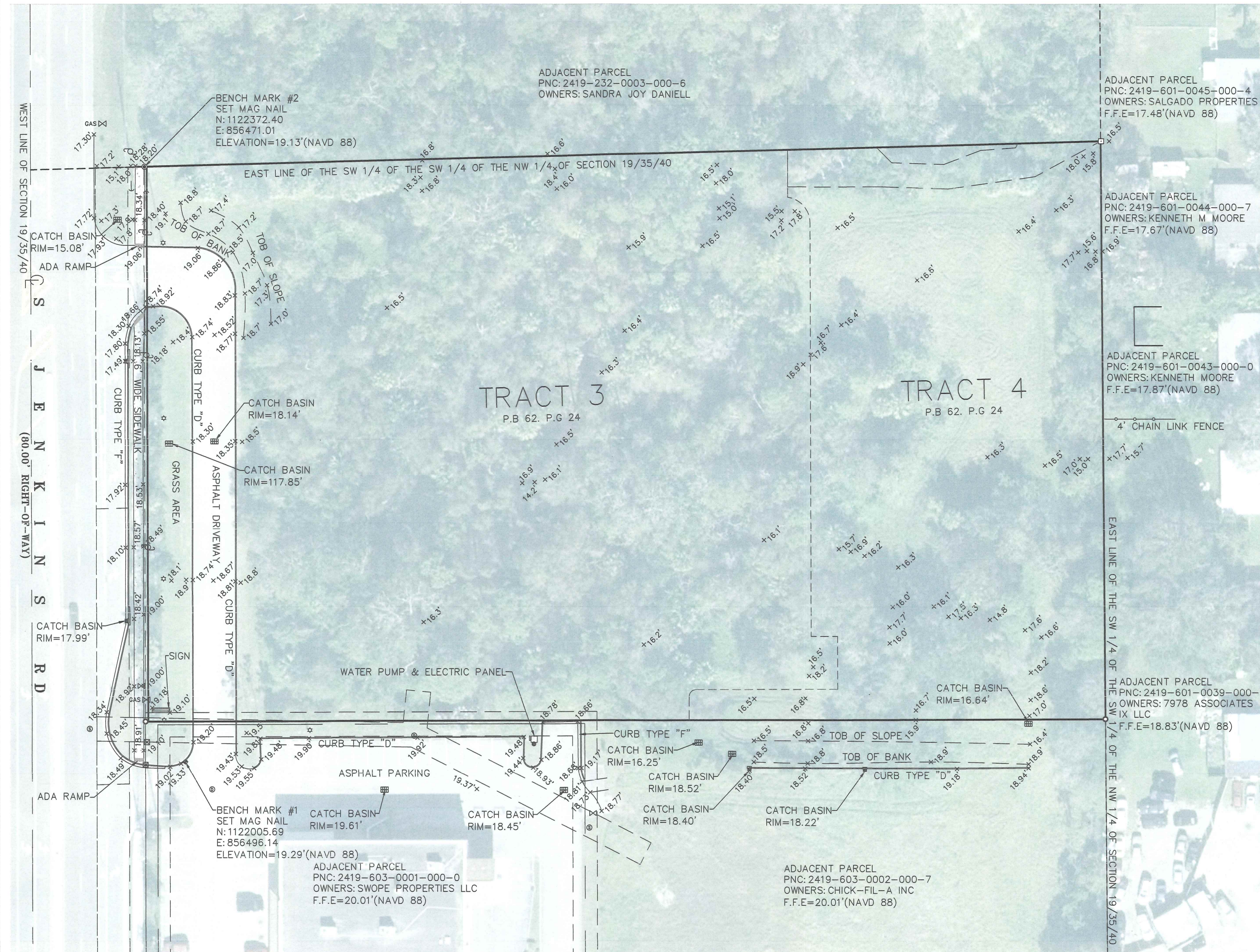

LEGAL DESCRIPTION:

PARCEL 1
TRACT 3, OF OKEECHOBEE CROSSINGS, ACCORDING TO THE PLAT THEREOF, RECORDED IN PLAT BOOK 62, AT PAGES 23 AND 24 OF THE PUBLIC RECORDS OF ST. LUCIE COUNTY, FLORIDA, LESS AND EXCEPT PROPERTY IN SPECIAL WARRANTY DEED RECORDED IN O.R. BOOK 3629, PAGE 89, PUBLIC RECORDS OF ST. LUCIE COUNTY, FLORIDA, DESCRIBED AS FOLLOWS:

A PORTION OF TRACT 3, OKEECHOBEE CROSSINGS, ACCORDING TO THE PLAT THEREOF, AS RECORDED IN PLAT BOOK 62, PAGE 23 OF THE PUBLIC RECORDS OF ST. LUCIE COUNTY, FLORIDA, LYING IN THE NORTHWEST 1/4 OF SECTION 19, TOWNSHIP 35 SOUTH, RANGE 40 EAST, ST. LUCIE COUNTY, FLORIDA; SAID PORTION BEING MORE PARTICULARLY DESCRIBED AS FOLLOWS:

BEGIN AT THE SOUTHWEST CORNER OF SAID TRACT 3, SAID POINT ALSO BEING ON THE EAST EXISTING RIGHT OF WAY LINE OF COUNTY ROAD 611 (JENKINS ROAD) AS SHOWN ON THE FLORIDA DEPARTMENT OF TRANSPORTATION RIGHT OF WAY MAP FOR ITEM/SEGMENT NO. 4289841, SECTION 9403-2516; THENCE NORTH 00°05'07" WEST, 341.52 FEET ALONG SAID EAST EXISTING RIGHT OF WAY LINE, BEING 70.00 FEET EAST OF AND PARALLEL WITH THE WEST LINE OF THE NORTHWEST 1/4 OF SAID SECTION 19 TO A POINT ON THE NORTHWEST CORNER OF SAID TRACT 3; THENCE NORTH 88°29'34" EAST, 1.75 FEET ALONG THE NORTH LINE OF SAID TRACT 3; THENCE SOUTH 00°05'07" EAST, 341.56 FEET ALONG A LINE BEING 71.75 FEET EAST OF AND PARALLEL WITH THE WEST LINE OF SAID NORTHWEST 1/4 TO A POINT ON THE SOUTH LINE OF SAID TRACT 3; THENCE SOUTH 89°54'41" WEST, 1.75 FEET ALONG SAID SOUTH LINE OF TRACT 3 TO THE POINT OF BEGINNING.

CONTAINING 3.23 ACRES, MORE OR LESS.

PARCEL 2
TRACT 4, OF OKEECHOBEE CROSSINGS, ACCORDING TO THE PLAT THEREOF, RECORDED IN PLAT BOOK 62, AT PAGES 23 AND 24 OF THE PUBLIC RECORDS OF ST. LUCIE COUNTY, FLORIDA,

CONTAINING 1.50 ACRES, MORE OR LESS.

SURVEYORS NOTES AND REPORT:

- REPRODUCTIONS OF THIS MAP ARE NOT VALID WITHOUT THE SIGNATURE AND ORIGINAL RAISED SEAL OF A FLORIDA LICENSED SURVEYOR AND MAPPER. THIS SURVEY CANNOT BE TRANSFERRED OR ASSIGNED WITHOUT THE SPECIFIC WRITTEN PERMISSION OF ENGINEERING, DESIGN AND CONSTRUCTION, INC. IT IS A VIOLATION OF CHAPTER 5J-17, FLORIDA ADMINISTRATIVE CODE, TO ALTER THIS SURVEY WITHOUT THE EXPRESS PRIOR WRITTEN CONSENT OF THE SURVEYOR. ADDITIONS AND/OR DELETIONS MADE TO THE FACE OF THIS SURVEY WILL MAKE THIS SURVEY INVALID.
- THE LAST DATE OF FIELD WORK WAS OCTOBER 5, 2020.
- CURRENT DESCRIPTION(S) SHOWN HEREON PROVIDED BY THE CLIENT. A TITLE SEARCH FOR THIS PROPERTY HAS NOT BEEN ABSTRACTED TO SHOW MATTERS OF RECORD SUCH AS EASEMENTS OR OTHER ENCUMBRANCES OR RESTRICTIONS.
- THE EXPECTED USE OF THE LAND, AS CLASSIFIED IN CHAPTER 5J-17.050-053, FLORIDA ADMINISTRATIVE CODE, IS "COMMERCIAL/HIGH RISK." THE MINIMUM RELATIVE DISTANCE ACCURACY FOR THIS TYPE OF BOUNDARY SURVEY IS 1 FOOT IN 10,000 FEET. THIS SURVEY EXCEEDS THE REQUIRED DISTANCE ACCURACY.
- THIS BOUNDARY SURVEY HAS BEEN REFERENCED TO THE FLORIDA STATE PLANE COORDINATE SYSTEM-EAST ZONE, NAD 83 (1990).
- SUB-SURFACE IMPROVEMENTS INCLUDING UNDERGROUND UTILITIES, UTILITY SERVICES, WERE NOT LOCATED AS PART OF THIS SURVEY.
- REVISIONS SHOWN HEREON DO NOT REPRESENT A "FIELD SURVEY UPDATE" UNLESS OTHERWISE NOTED.
- BEARINGS SHOWN HEREON ARE BASED UPON THE LINE LABELED HERON AS (BEARING BASIS) AND ALL OTHER BEARINGS ARE RELATIVE THERETO. DISTANCES ARE IN U.S. SURVEY FEET AND DECIMAL PARTS THEREOF.
- ELEVATIONS SHOWN HEREON ARE RELATIVE TO THE NORTH AMERICAN VERTICAL DATUM OF 1988 (NAVD88) AND ARE BASED ON GPS REAL TIME KINEMATIC (RTK) OBSERVATION. SITE BENCHMARKS UTILIZED ARE SHOWN HEREON.
- THIS SITE WAS SURVEYED UTILIZING TRIMBLE/SPECTRA HARDWARE TOGETHER WITH SPECTRA SURVEY PRO REAL TIME PROCESSING AND WAS BASED ON TRIMBLE'S "VRS NOW" NETWORK AND/OR THE FLORIDA PERMANENT REFERENCE NETWORK (FPRN). THE PROCEDURES AND NETWORK DESIGN MEETS THE GEODETIC ACCURACY STANDARDS AND SPECIFICATIONS FOR USING GPS RELATED POSITIONING AS SET FORTH BY THE FEDERAL GEODETIC CONTROL COMMITTEE IN THE MOST CURRENT PUBLICATION FOR 3RD ORDER CLASS ONE FOR HORIZONTAL CONTROL SURVEYS.
- IN SOME INSTANCES, GRAPHIC REPRESENTATIONS AND SYMBOLS SHOWN HAVE BEEN EXAGGERATED TO MORE CLEARLY ILLUSTRATE THE RELATIONSHIP BETWEEN PHYSICAL IMPROVEMENTS AND/OR LOT LINES. THE DIMENSIONS SHOWN SHALL CONTROL THE LOCATION, OF THE IMPROVEMENTS, OVER THE SCALED POSITIONS.
- THE OWNERSHIP OF PERIMETER FENCES, WALLS, HEDGES AND LANDSCAPING, IF ANY, SHOWN HEREON ARE NOT KNOWN AND ARE NOT LISTED AS ENCROACHMENTS. THEIR RELATIVE LOCATION IS SHOWN IN RELATION TO THE BOUNDARY LINES SHOWN.
- THE SURVEY MAP SHOWN HEREON DOES NOT NECESSARILY CONTAIN ALL OF THE INFORMATION OBTAINED OR DEVELOPED BY THE UNDERSIGNED SURVEYOR IN HIS FIELD WORK, OFFICE WORK OR RESEARCH.
- THE PROPERTY WHICH IS THE SUBJECT OF THIS SURVEY APPEARS TO BE SITUATE IN AN AREA OF MINIMAL FLOOD ZONE X HAZARD AT THIS TIME PURSUANT TO F.E.M.A. FIRM NUMBER 1211001674, HAVING AN EFFECTIVE DATE OF FEBRUARY 16, 2012. FOR APPROXIMATE DELINEATION OF THE FLOOD ZONE LIMITS, REFER TO AFOREMENTIONED FIRM PANELS.

SYMBOL & ABBREVIATION LEGEND:

⊕	AIR RELEASE VALVE	⊕	CONCRETE POWER POLE	⊕	FEMA FEDERAL EMERGENCY MANAGEMENT AGENCY	⊕	GUY WIRE ANCHOR	⊕	METAL LIGHT POST	⊕	PERMANENT CONTROL POINT	R/W	RIGHT-OF-WAY	T.O.N.	TOP OF NUT	⊕	WOOD POLE STREET LIGHT
AL	ARC LENGTH	⊕	CONCRETE POWER POLE	F.O.H.	FIBER OPTIC HAND HOLE	⊕	HANDICAP	⊕	METAL POWER POLE	PRM	PERMANENT REFERENCE POINT	R/C	ROD AND CAP	X 0.0	TOPOGRAPHIC DATA (SOFT SURFACE)	⊕	WOOD POWER POLE
ASPH	ASPHALT	⊕	CONCRETE POWER POLE	F.O.H.	FIBER OPTIC HAND HOLE	⊕	HANDICAP	⊕	METAL POWER POLE	P.B.	PLAT BOOK	S	SANITARY MANHOLE	X 0.00	TOPOGRAPHIC DATA (HARD SURFACE)	⊕	
BFP	BACK FLOW PREVENTER	⊕	CONCRETE POWER POLE	F.O.H.	FIBER OPTIC HAND HOLE	⊕	HANDICAP	⊕	METAL POWER POLE	(P)	PLAT DATA	SV	SANITARY VALVE	⊕	TOWNSHIP	⊕	
BW	BENCHMARK (BM)	⊕	CONCRETE POWER POLE	F.O.H.	FIBER OPTIC HAND HOLE	⊕	HANDICAP	⊕	METAL POWER POLE	P.O.B.	POINT OF BEGINNING	SEC	SECTION	⊕	TRAFFIC HANDHOLD	⊕	
BR	BIKE RACK	⊕	CONCRETE POWER POLE	F.O.H.	FIBER OPTIC HAND HOLE	⊕	HANDICAP	⊕	METAL POWER POLE	P.C.C.	POINT OF COMMENCEMENT	⊕	PROPERTY CORNER	⊕	TRAFFIC SIGNAL CONTROL BOX	⊕	
CR	CABLE RISER	⊕	CONCRETE POWER POLE	F.O.H.	FIBER OPTIC HAND HOLE	⊕	HANDICAP	⊕	METAL POWER POLE	P.C.C.	POINT OF COMPOUND CURVE	⊕	RIGHT-OF-WAY CONTROL SIGN	⊕	TYPICAL	⊕	
CL	CALCULATED	⊕	CONCRETE POWER POLE	F.O.H.	FIBER OPTIC HAND HOLE	⊕	HANDICAP	⊕	METAL POWER POLE	P.C.	POINT OF CURVATURE	⊕	UNKNOWN	⊕	UNKNOWN HANDHOLD	⊕	
CB	CATCH BASIN	⊕	CONCRETE POWER POLE	F.O.H.	FIBER OPTIC HAND HOLE	⊕	HANDICAP	⊕	METAL POWER POLE	P.T.	POINT OF TANGENCY	⊕	UNKNOWN RISER BOX	⊕	UNKNOWN TYPE MANHOLE	⊕	
CD	CENTERLINE	⊕	CONCRETE POWER POLE	F.O.H.	FIBER OPTIC HAND HOLE	⊕	HANDICAP	⊕	METAL POWER POLE	P.O.T.	POINT OF TERMINUS	⊕	VCP	VITRIFIED CLAY PIPE	⊕		
CC	CERTIFIED CORNER RECORD	⊕	CONCRETE POWER POLE	F.O.H.	FIBER OPTIC HAND HOLE	⊕	HANDICAP	⊕	METAL POWER POLE	P.V.C.	POLYVINYL CHLORIDE VALVE	⊕	WM	WATER METER	⊕		
CH	CHORD	⊕	CONCRETE POWER POLE	F.O.H.	FIBER OPTIC HAND HOLE	⊕	HANDICAP	⊕	METAL POWER POLE	PLS	PROFESSIONAL LAND SURVEYOR	⊕	WS	WATER SERVICE METER (WM)	⊕		
CO	CLEAN OUT	⊕	CONCRETE POWER POLE	F.O.H.	FIBER OPTIC HAND HOLE	⊕	HANDICAP	⊕	METAL POWER POLE	R	RADIUS	⊕	WV	WATER VALVE (WV)	⊕		
CM	CONCRETE MONUMENT	⊕	CONCRETE POWER POLE	F.O.H.	FIBER OPTIC HAND HOLE	⊕	HANDICAP	⊕	METAL POWER POLE	RGE	RANGE	⊕	W	WEST	⊕		
		⊕	CONCRETE POWER POLE	F.O.H.	FIBER OPTIC HAND HOLE	⊕	HANDICAP	⊕	METAL POWER POLE	RTK	RECLAIMED WATER VALVE	⊕	WF	WOOD FENCE	⊕		
		⊕	CONCRETE POWER POLE	F.O.H.	FIBER OPTIC HAND HOLE	⊕	HANDICAP	⊕	METAL POWER POLE	RNV	REGISTERED LAND SURVEYOR	⊕	TOE	TOE OF BANK/BERM	⊕		
		⊕	CONCRETE POWER POLE	F.O.H.	FIBER OPTIC HAND HOLE	⊕	HANDICAP	⊕	METAL POWER POLE	RLS	REGISTERED LAND SURVEYOR	⊕	TOE	TOE OF BANK/BERM	⊕		
		⊕	CONCRETE POWER POLE	F.O.H.	FIBER OPTIC HAND HOLE	⊕	HANDICAP	⊕	METAL POWER POLE	RCP	REINFORCED CONCRETE PIPE	⊕	TOE	TOE OF BANK/BERM	⊕		

Michael T. Owen
MICHAEL T. OWEN PROFESSIONAL SURVEYOR AND MAPPER
FLORIDA REGISTRATION #5556

04/2021
SIGNATURE DATE:

**BOUNDARY & TOPOGRAPHIC SURVEY
FOR: FLAGSHIP STORAGE**

RECORD INFORMATION
SEC. 19, TOWNSHIP. 35 SOUTH, RGE. 40 EAST
ST. LUCIE COUNTY, FLORIDA

EDC
10250 VILLAGE PARKWAY
UNIT 201
PORT ST. LUCIE, FL 34987
772-462-2455

21-141

1 OF 2

24/EDC/2021/01-241 - Flagship Storage - Jenkins & Okeechobee Survey - PDF Survey/21-241 Boundary & Topographic Survey.dwg, 04/2021 12:02 PM
 COPYRIGHT 2020 BY EDC-INC. THIS FIRM EXPRESSLY RESERVES THEIR EXCLUSIVE COMMON LAW COPYRIGHT AND INTELLECTUAL PROPERTY RIGHTS TO THESE DRAWINGS WHICH MAY NOT BE REPRODUCED, REPRODUCED, CHANGED OR COPIED IN ANY FORM OR MANNER, NOR ARE THEY TO BE ASSIGNED TO ANY PARTY WITHOUT THE WRITTEN CONSENT OF THIS FIRM.
 THIS DOCUMENT, TOGETHER WITH THE CONCEPTS AND DESIGNS PRESENTED HEREIN, IS AN INSTRUMENT OF SERVICE. NO INSTRUMENT OF SERVICE IS INTENDED ONLY FOR THE SPECIFIC PURPOSE AND CLIENT FOR WHICH IT WAS PREPARED. REUSE OF AND IMPROPER RELIANCE ON THIS DOCUMENT WITHOUT WRITTEN AUTHORIZATION AND ACCEPTANCE BY EDC, INC. SHALL BE WITHOUT LIABILITY TO EDC, INC.

Z:\EDC-2021\31-241 - Flagship Storage - Jenkins & Okeechobee\ENGINEERING\AutoCAD\DWG\31-241 FlagshipSite.dwg, SITE PLAN, 9/16/2021 1:52:26 PM, James, EDC, Inc.

THIS DOCUMENT, TOGETHER WITH THE CONCEPTS AND DESIGNS PRESENTED HEREIN, AS AN INSTRUMENT OF SERVICE, IS INTENDED ONLY FOR THE SPECIFIC PURPOSE AND CLIENT FOR WHICH IT WAS PREPARED. REUSE OF AND IMPROPER RELIANCE ON THIS DOCUMENT WITHOUT WRITTEN AUTHORIZATION AND ADOPTION BY EDC, INC. SHALL BE WITHOUT LIABILITY TO EDC, INC.

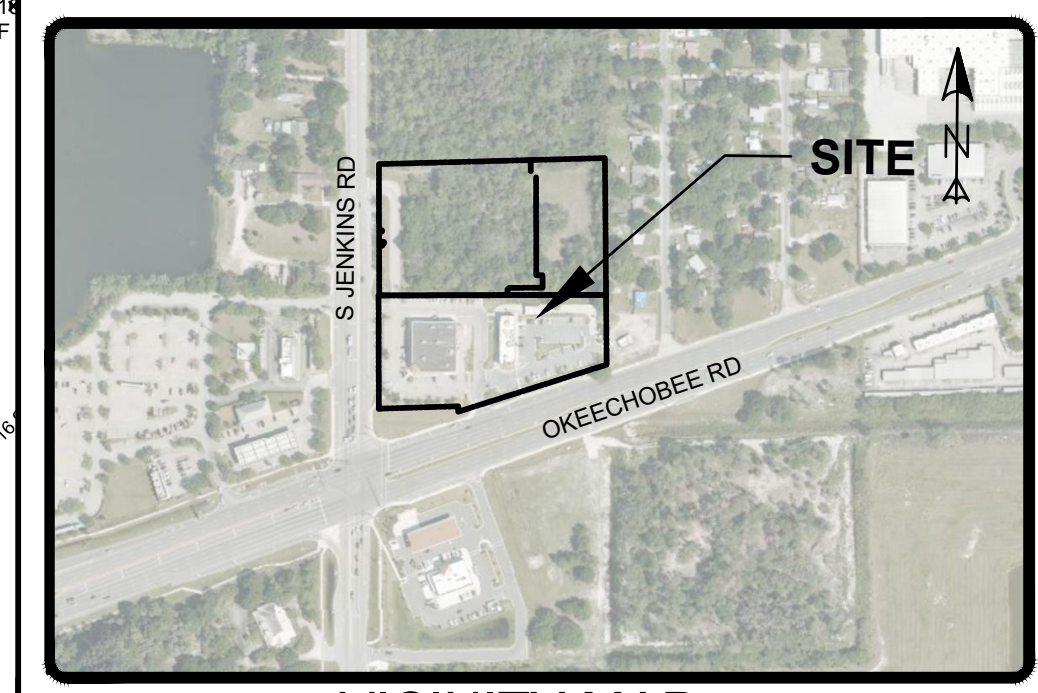
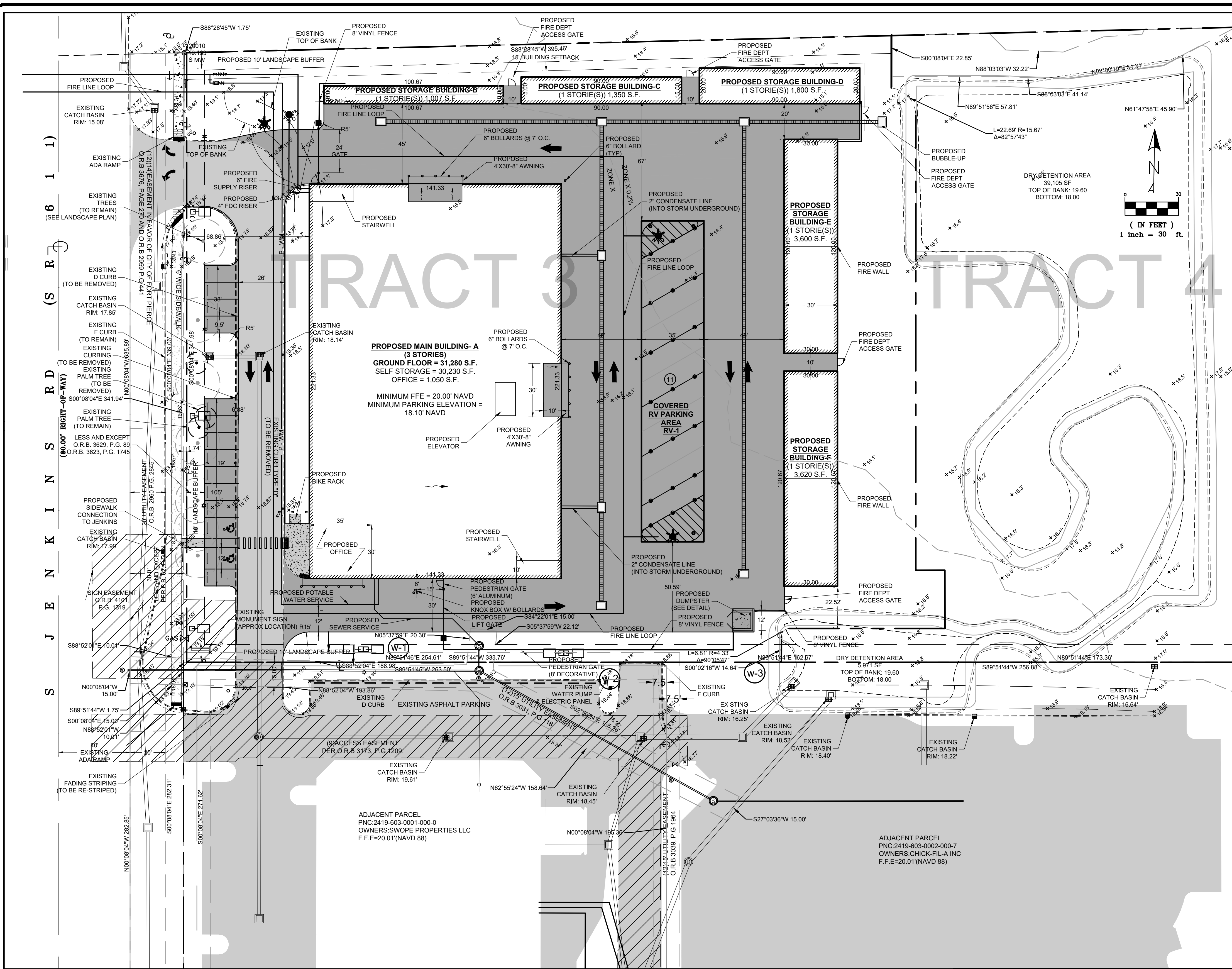

VICINITY MAP SCALE: 1:500

LEGAL DESCRIPTION OKEECHOBEE CROSSINGS-(PB 62-23) TRACT 3 LESS THAT PORTION FOR ROAD R/W AS IN OR 3629-89 (3.22 AC - 140,536 SF) OKEECHOBEE CROSSINGS-(PB 62-23) TRACT 4 (1.50 AC - 65,340 SF) (REF. ST. LUCIE COUNTY PROPERTY APPRAISER)

PARCEL ID #: 2419-603-0003-000-4 (TRACT 3) 2419-603-0004-000-1 (TRACT 4) PROJECT NAME: FLAGSHIP STORAGE OWNER: NNN1031 #16 JENKINS LLC 2 TOWNE SQ STE 900 SOUTHFIELD, MI 48076 FUTURE LAND USE: GC GENERAL COMMERCIAL ZONING: C-3 COMMERCIAL

Table with 2 columns: Building Name and Square Footage. Includes rows for Main Building-A, Storage Buildings B-F, and Covered RV Parking Area-RV1.

SETBACKS FRONT: 25' SIDE: 10' REAR: 25'

Table with 3 columns: Area Type, Area (S.F.), and Percentage. Includes rows for Site Area Breakdown, ImperVIOUS Area, and PerVIOUS Area.

USEABLE OPEN SPACE AREA: REQUIRED = 56,066 S.F. @ 0.5% = 2,803 S.F. PROPOSED = 2,803 S.F.

PROVIDER OF UTILITIES: WATER: FPUA WASTEWATER: FPUA IRRIGATION: WASTE PRO SOLID WASTES: WASTE PRO

SETBACKS FRONT: 25' SIDE: 15' REAR: 20'

PARKING CALCULATIONS ITE PARKING GENERATION MANUAL, 5TH EDITION PARKING REQUIRED OFFICE(10) (1,050 S.F.) (1 SPACES/300 S.F) 4 SPACES MINI-WAREHOUSE(181) (1 SPACES/10,000 S.F) 10 SPACES TOTAL REQUIRED PARKING SPACES 14 SPACES (1 HC)

STANDARD PARKING PROVIDED 14 SPACES (2 HC) RV STORAGE SPOTS PROVIDED 11 SPACES

STORMWATER DRAINAGE: THE SURFACE WATER MANAGEMENT SYSTEM FOR THE PROJECT WILL COLLECT SITE RUNOFF IN A SERIES OF INLETS WHICH WILL CONVEY THE RUNOFF TO THE EXISTING MASTER DRAINAGE SYSTEM.

SOLID WASTE: BASED ON THE INTENDED USE OF THE BUILDING, THIS PROJECT WILL UTILIZE A DUMPSTER AREA FOR SOLID WASTE AND RECYCLABLE ITEMS.

HAZARDOUS WASTE: ANY AND ALL HAZARDOUS OR TOXIC MATERIALS GENERATED OR USED OR STORED ON SITE SHALL BE DISPOSED OF IN ACCORDANCE WITH ALL LOCAL, STATE AND FEDERAL REGULATIONS.

LANDSCAPE: REFER TO LANDSCAPE PLAN BY OTHERS. (NO PLANS AVAILABLE)

ACCESSIBILITY AND ADA COMPLIANCE: ALL SIDEWALKS AND RAMPS WILL MEET FDOT AND ADA REQUIREMENTS. TRAFFIC STATEMENT

EDC ENGINEERS & SURVEYORS ENVIRONMENTAL PORT SAINT LUCIE OFFICE 10250 SW VILLAGE PARKWAY, SUITE 201 PORT SAINT LUCIE, FL 34987 772-462-2455 www.edc-inc.com F.B.P.E. CERTIFICATE OF AUTHORIZATION 9935 L.B. CERTIFICATE OF AUTHORIZATION 8098

Table with 2 columns: Role and Name. Includes Designer, Drafter, and Checker.

Table with 2 columns: Revision Number and Description. Lists revisions for the site plan.

FLAGSHIP STORAGE SITE PLAN FLORIDA FORT PIERCE

EDC ENGINEERS & SURVEYORS ENVIRONMENTAL 10250 SW VILLAGE PARKWAY, SUITE 201 PORT SAINT LUCIE, FL 34987 772-462-2455

GENERAL NOTE: ALL BUILDING, PARKING AND ACCESS AREAS SHALL DOCUMENT COMPLIANCE WITH THE REQUIREMENTS OF THE AMERICAN DISABILITIES ACT PRIOR TO THE ISSUANCE OF A BUILDING PERMIT. ALL PROHIBITED EXOTIC PLANT SPECIES SHALL BE REMOVED AND ALL REQUIRED LANDSCAPING SHALL BE INSTALLED PRIOR TO THE ISSUANCE OF A CERTIFICATE OF OCCUPANCY. REFER TO LANDSCAPE PLANS FOR LANDSCAPE DETAILS AND SPECIFICATIONS. PROPOSED LIGHT POLES SHALL BE SHIELDED TO MINIMIZE EXCESS GLARE TO ADJACENT ROADWAYS. ADDITIONALLY, ALL LIGHT FIXTURES WITHIN VEHICULAR USE AREAS SHALL HAVE A MAX HEIGHT OF 30', AND ALL LIGHT FIXTURES WITHIN PEDESTRIAN USE AREAS SHALL HAVE A MAX HEIGHT OF 20'. BIKE RACKS SHALL BE THE INVERTED 'U' TYPE AND CONSISTENT WITH CITY OF FORT PIERCE CODE. ALL SIGNS SHALL BE CONSISTENT WITH CITY OF FORT PIERCE CODE SIGN CODE.

Table with 5 columns: Description, Found (Yes/No), Agency Contact Information, Management Plan (Yes/No), Relocation Plan (Yes/No). Lists environmental findings like Wetlands and Threatened Species.

LEGEND Table with 2 columns: Symbol and Description. Lists symbols for existing meters, proposed signs, concrete, pavement, and drainage pipes.

Flagship Storage

Jenkins Road
City of Fort Pierce, Florida

City Project Number:

Jeffrey W. Smith, RLA
Florida Registration Number:
LA 0001635

Job No. 21-0403
Drawn By JWS
Submittal Dates 6-30-2021
9-7-2021 9-14-2021

Revision Dates
City Comments #1 9-7-2021
Base Update 9-14-2021

These drawings are the property of the landscape architect and are not to be used for other projects except by written permission from the landscape architect. Report any discrepancies immediately to the landscape architect.

L-1 2
Sheet of

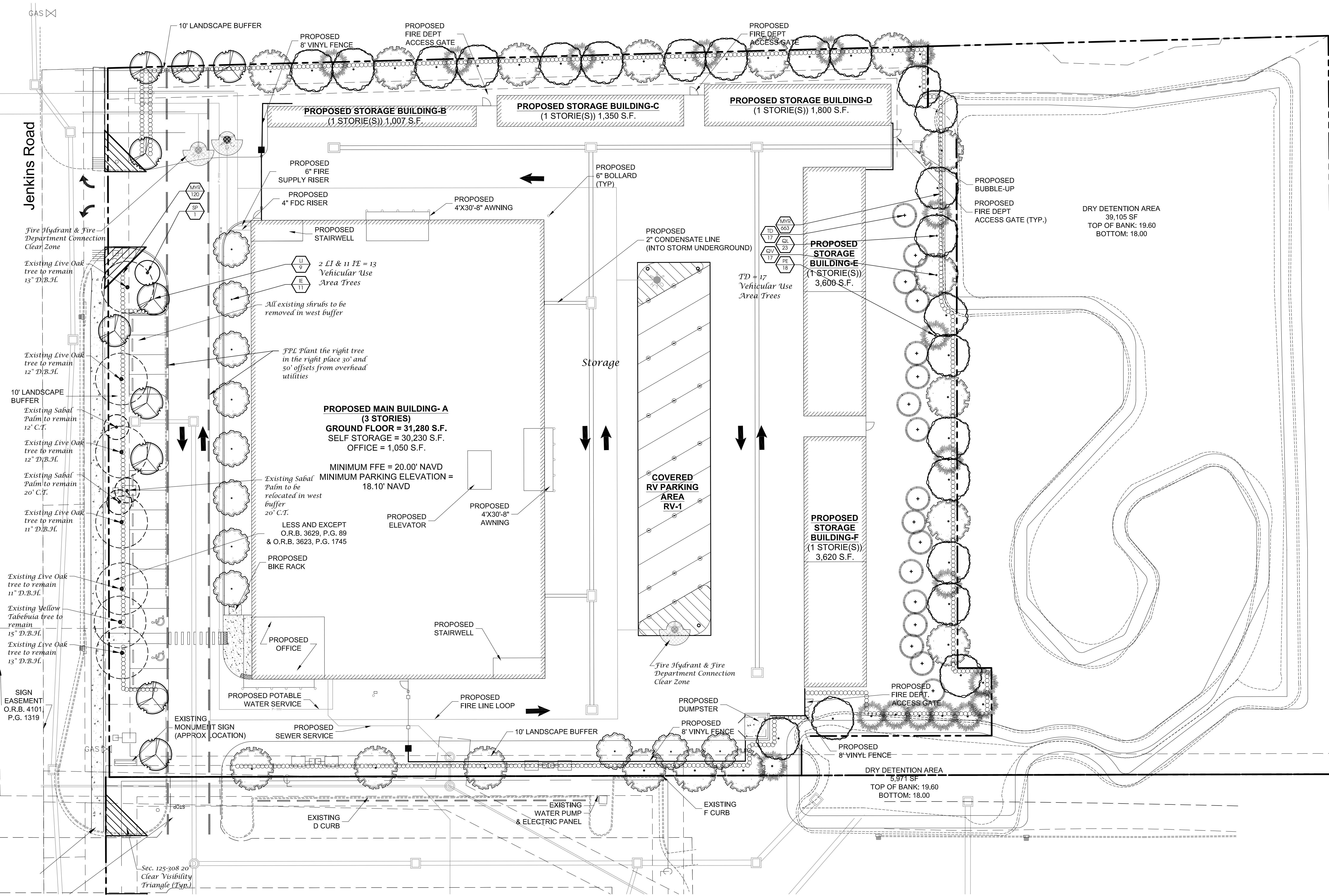

Landscape Plan

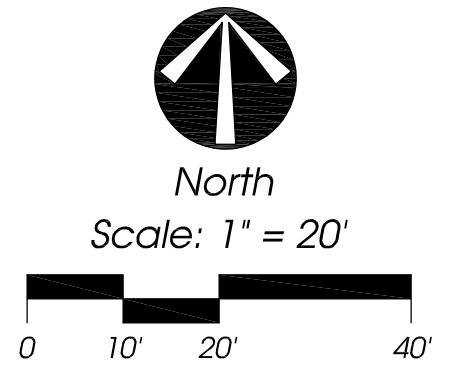

Landscape Specifications

- All tree and plant material to be Florida No. 1 or better, as classified in "Grades and Standards for Nursery Plants", Part I and Part II, State of Florida, Dept. of Agriculture, Tallahassee. All plants not listed in "Grades and Standards for Nursery Plants" shall conform to a Florida No. 1 as to: (1) health and vitality, (2) condition of foliage, (3) root system, (4) freedom from pest or mechanical damage, (5) heavily branched and densely foliated according to the accepted normal shape of the species.
- Understanding or substitution of one species or cultivar for another species is a breach of contract and will be "Rejected" at the time of final landscape inspection unless approved by Landscape Architect.
- Project Warranty: All plant material shall be warranted for a period of one (1) year after date of substantial completion against defects, including death and unsatisfactory growth, except for defects resulting from abuse or damage by others or unusual phenomena or incidents which are beyond the contractor's control.
- Any and all conditions which the contractor feels will be detrimental to the success of the planting shall be brought to the owner or representative's attention.
- The contractor shall verify the location of underground utilities prior to commencing work on any project area.
- Mulch planting areas with 3" layer of Melaleuca, Eucalyptus, or Enviromulch. Cypress Mulch is NOT ACCEPTABLE. Planting beds to receive mulch throughout entire bed area.
- All plants to be set to ultimate grade. No filling will be permitted around trunks or stems. Mulch to be kept a minimum of 2" away from trunks and stems.
- Planting trees and shrubs: Excavate hole per planting detail. When plant is set, place additional backfill consisting of a 50% mixture of Peat Humus and natural soil around the base and sides of ball, and work each layer to settle backfill and eliminate voids and air pockets. When excavation is approximately 2/3 full, water thoroughly before placing remainder of backfill. Water again after placing final layer of backfill and before installing mulch.
- Guy and stake trees in 3 directions with galvanized wire, through flexible hose chafing guards, with wooden stake anchors. Immediately after planting. (See Detail).
- Trees and shrubs shall be fertilized with a complete natural organic fertilizer with a ratio of approximately 3:0:2 or 3:0:3 (e.g., one labeled 12-0-8). Similar analysis such as 16-0-8 (4:0:2) can also be used. Fertilizers that are slow release, controlled release, sulphur coated or with nitrogen as IBDU or ureaformaldehyde have extended release period. Thirty to fifty percent of the nitrogen should be water insoluble or slow release.

Palms should receive a complete granular fertilizer formulated for palms ("Palm Special") at a rate of 5 to 8 lbs. per palm.

Agriform 20-0-5 twenty-one gram planting tablets may be substituted for granular fertilizer. If utilized, the following rates shall be utilized: Position plant in hole. Backfill halfway up the rootball. Place tablet(s) beside rootball about 1" from root pits. Do not place tablet(s) in bottom of hole.

- 1 Gallon 1 Tablet
- 3 Gallon 2 Tablets
- 25 Gallon & B&B Trees 2 per 1" caliper

- All planting areas and sod to be irrigated to provide 100% coverage. Shop drawings to be submitted by the irrigation contractor for approval prior to installation.
- Maintain trees, shrubs, and other plants by watering, cultivating, and weeding as required for healthy growth. Restore planting saucers and mulch. Tighten and repair stake and guying and reset trees and shrubs to proper grade or vertical position as required. Spray as necessary to keep trees and shrubs free of insects and disease. The contractor shall begin maintenance immediately after planting and shall continue maintenance through final acceptance when Certificate of Occupancy is issued to the General Contractor by City and project is released by the General Contractor to Client.
- Prune trees and shrubs lightly to remove damaged branches as directed by the Landscape Architect.
- Planting Lawns: Provide clean, strongly rooted, uniformly sized strips of Stenotaphrum secundatum Floritum (unless otherwise noted), machine stripped not more than 24 hours prior to laying. Grade and roll prepared lawn surface. Water thoroughly but not to create muddy soil conditions. Lay sod strips with tight joints, roll or tamp lightly, and water thoroughly.
- Maintain positive drainage, no planting is to block drainage.

- Drainage Testing
 - Prior to planting of trees, palms, and specimen material, each planting pit shall be tested in the following manner to verify adequate drainage.
 - Dig each planting pit to the minimum specified size.
 - Fill the planting pit with (12) twelve inches of water. If the water level in the planting pit drops (4") four or more inches within (4) four hours, the drainage is sufficient and a drainage channel is not required. If the water level drops less than (4") four inches within the (4) four hour period, then a drainage channel is required.
 - When a drainage channel is required, the drainage channel must extend down through the non porous soil and into porous soil. (See Drainage Testing Detail)
 - Discard all material removed from the drainage channel.
 - When backfilling the planting pit, add course gravel to the drainage channel. Also, care must be taken to keep the consistency of the soil mix the same throughout the planting pit.

- Contractor to include drainage testing for all trees and palms in bid. If drainage is inadequate, the soil specification in Item #8 above shall be revised for site conditions. Contractor shall notify the Owner and Landscape Architect of poor drainage conditions in writing and written direction will be provided to the contractor of appropriate soil mixture specification to be used.
- All fertilizers shall meet the City of Port St. Lucie's fertilizer ordinance.

Plant List

QTY	SYM	SPECIES	COMMON NAME/DESCRIPTION	SIZE	SPACING	REMARKS
CANOPY / ORNAMENTAL TREES						
11	IE*	ILEX x ATTENUATA 'EAGLESTON'	EAGLESTON HOLLY	12' x 5', 2.5" D.B.H.	A.S.	FULL CANOPY, 5' C.T. MIN.
9	LI	LAGERSTROEMIA INDICA 'NATCHEZ'	CRAPE MYRTLE 'WHITE'	12' x 5', 2.5" D.B.H.	A.S.	FULL CANOPY, 5' C.T. MIN.
18	PE*	PINUS ELLIOTTI	SLASH PINE	12' x 5', 2.5" D.B.H.	A.S.	FULL CANOPY, 5' C.T. MIN.
23	QL*	QUERCUS LAURIFOLIA	LAUREL OAK	12' x 5', 2.5" D.B.H.	A.S.	FULL CANOPY, 5' C.T. MIN.
17	QV*	QUERCUS VIRGINIANA	LIVE OAK	12' x 5', 2.5" D.B.H.	A.S.	FULL CANOPY, 5' C.T. MIN.
17	TD*	TAXODIUM DISTICHUM	BALD CYPRESS	12' x 5', 2.5" D.B.H.	A.S.	FULL CANOPY, 5' C.T. MIN.
PALMS						
1	SP*	SABAL PALMETTO	SABAL PALM	EXISTING	A.S.	RELOCATED FROM ON SITE
SHRUBS / GROUNDCOVERS						
783	MYR*	MYRICANTHES FRAGRANS	SIMPSON STOPPER	#3, 2' x 2'	2" O.C.	FULL & THICK
	SOD-1	PASPALUM NOTATUM	BAHIA SOD			SEE SPECS

* = Florida Native

NOTE: D.B.H. IS MEASURED 4.5' ABOVE GRADE

Landscape Data

Vehicular Use Area Landscaping Adjacent to R.O.W. (West Buffer) 341.84'

Sec. 123-37(4)(b)
Trees Required = 10' Wide Landscape Strip with 1 Tree/300 s.f.
341.84 l.f. x 10' = 3,418.4 s.f. / 300 = 12 Trees
Provided = 7 Existing buffer trees to remain + 5 Planted trees = 12

Shrubs Required = Continuous Hedge @ 2" o.c.
341.84 l.f. / 2" o.c. = 180 Shrubs
Provided = 180

Vehicular Use Area Landscaping to Adjacent Property (North, South & East Buffer) 1,204.45'

Sec. 123-37(6)
Trees Required = 10' Wide Landscape Strip with 1 Tree/200 s.f.
1,204.45 l.f. x 10' = 12,044.5 s.f. / 200 = 60 Trees
Provided = 60

Shrubs Required = Continuous Hedge @ 2" o.c.
1,204.45 l.f. / 2" o.c. = 603 Shrubs
Provided = 603 Shrubs

Interior Vehicular Use Area

Sec. 123-37(7)(a & b)
Required = 1 s.f. of interior landscaping per 15 s.f. of vehicular use area (45,729 s.f. / 15 = 3,048.6 s.f.)
Landscape Area Provided = 3,048.6 s.f.
Trees Required = 1 Tree/100 s.f. of interior landscape area
45,729 s.f. / 15 = 3,048.6 s.f. / 100 = 30 Trees
Trees Provided = 30 (Note: some tree relocated to dry retention area to enhance water quality)

Total Trees Required = 102 Trees
Total Trees Provided = 102 Trees
95 Planted Trees + 7 Existing Jenkins Road Buffer = 102 Trees

Total Trees Required = 102 Trees
Total Native Trees Provided = 101 (99%)

Total Palms Required = 0
Total Native Palms Provided = 0 (N/A - %)

Total Shrubs Required = 783
Total Native Shrubs Provided = 783 (100%)

Landscape Details

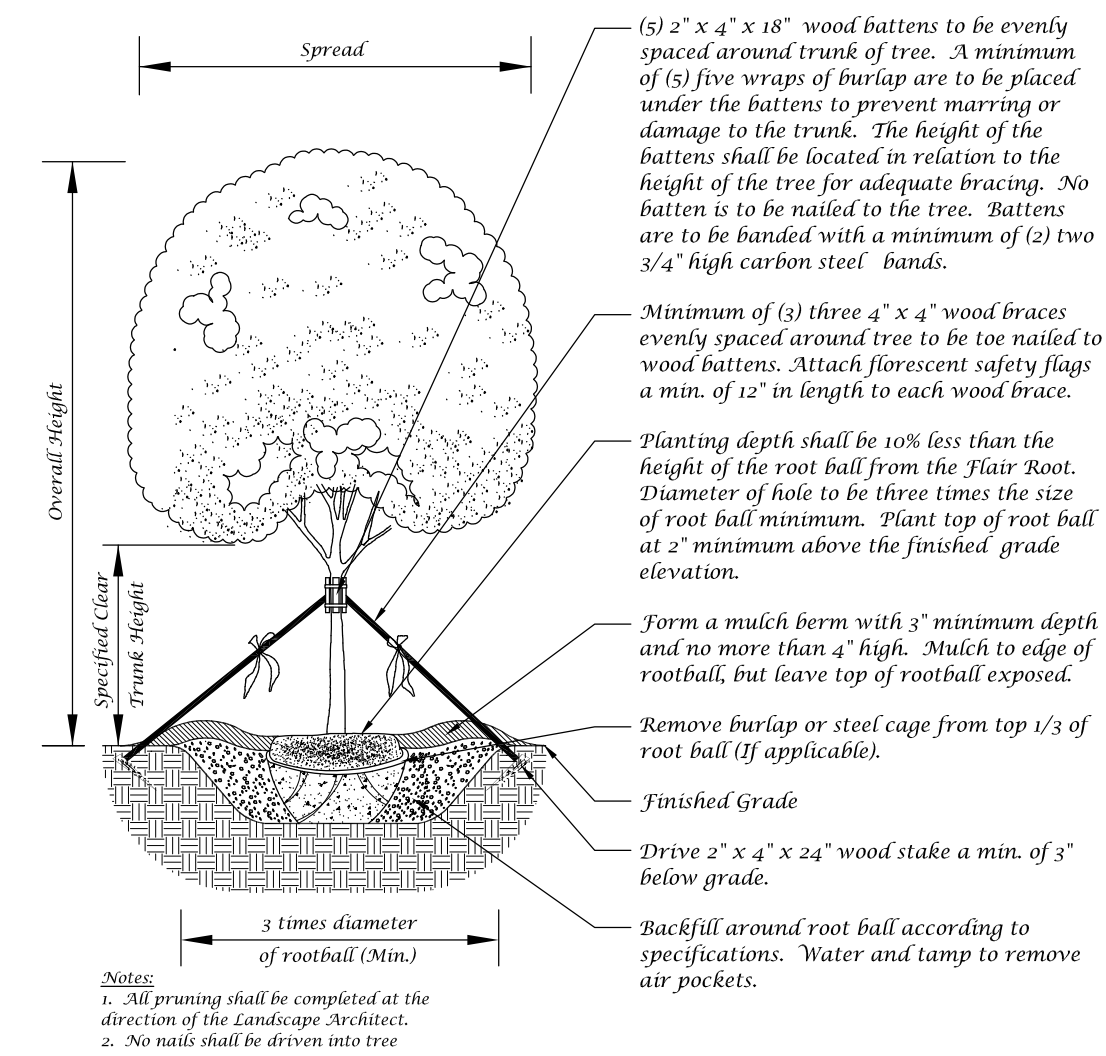

Tree Planting Detail

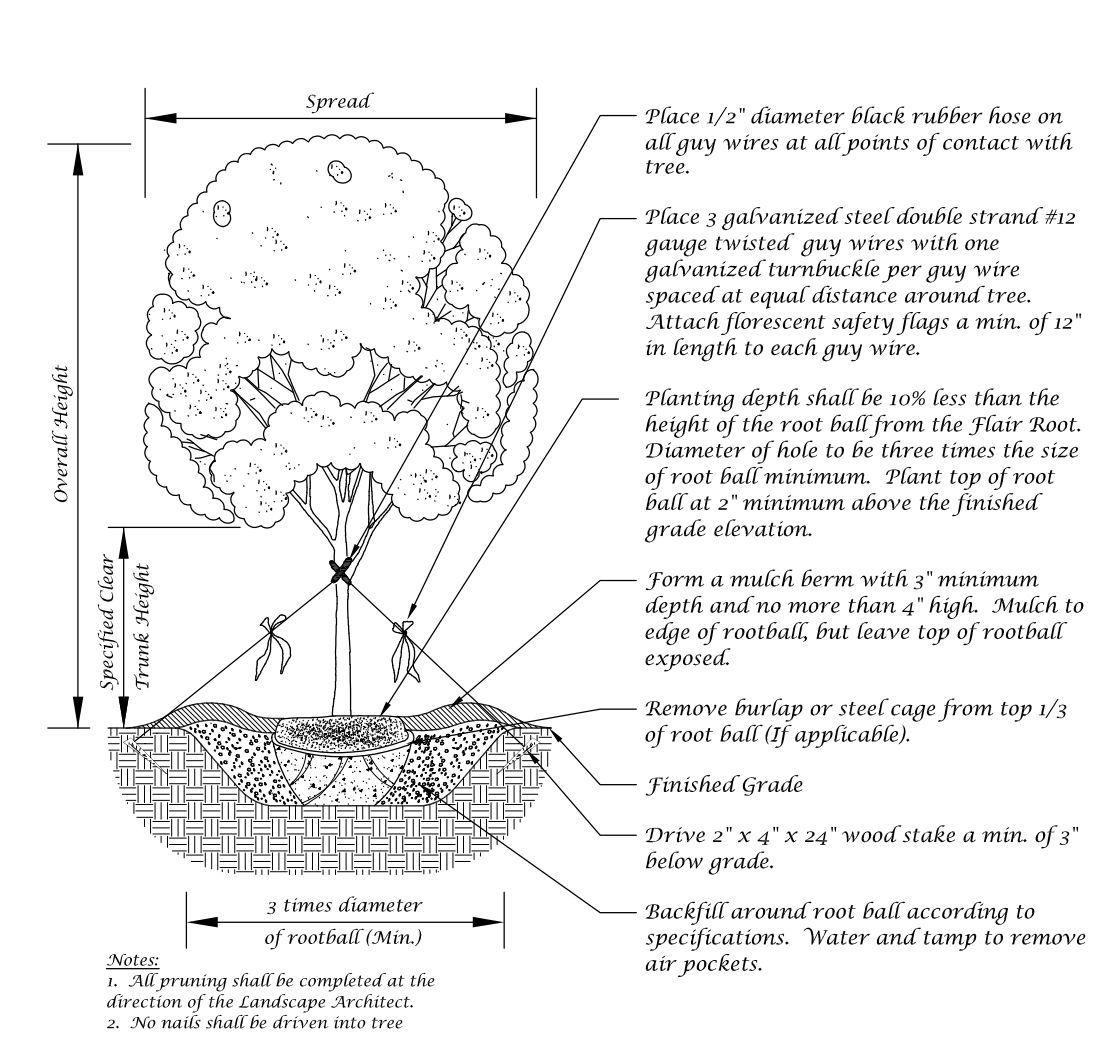

Multi-Trunk Tree Planting Detail

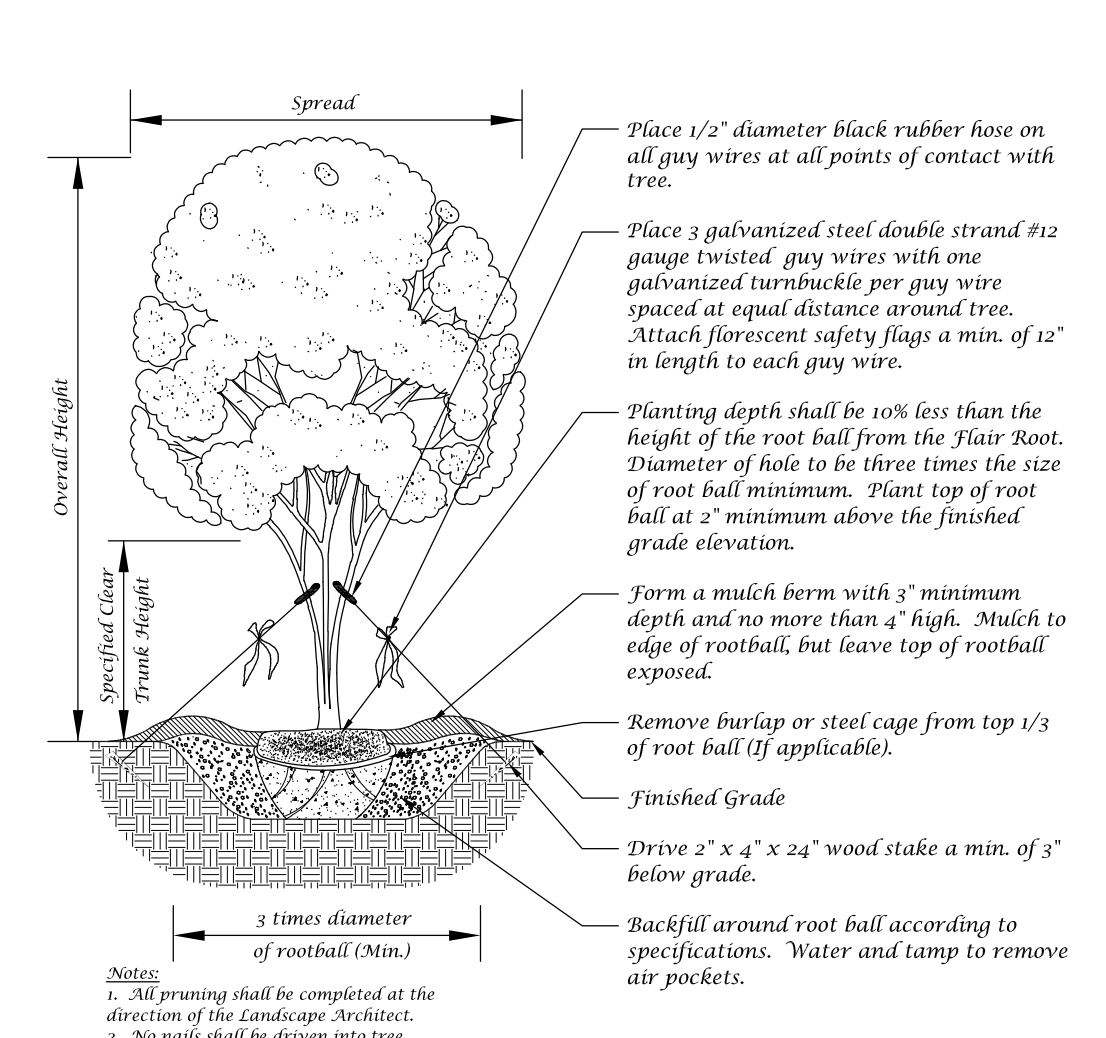

Palm Planting Detail

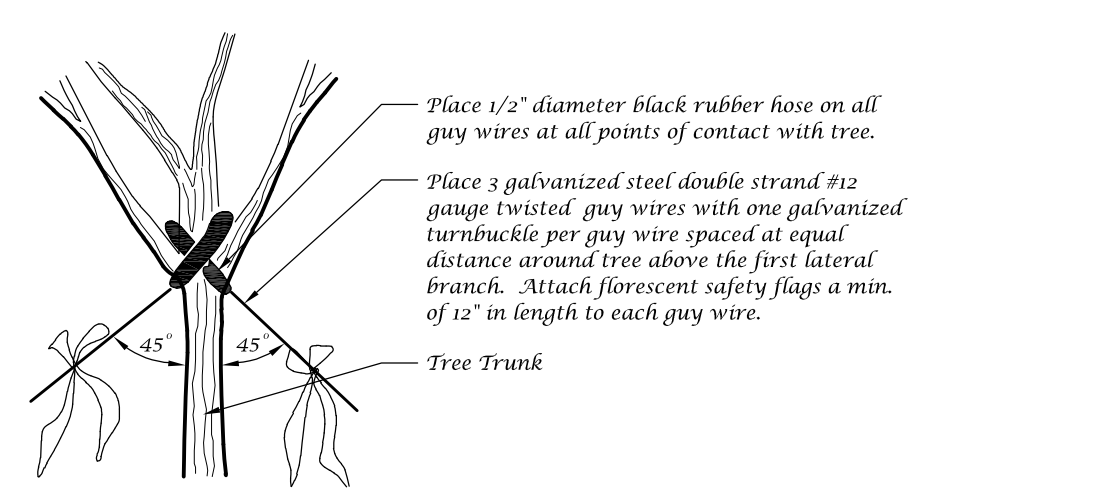

Staking Detail

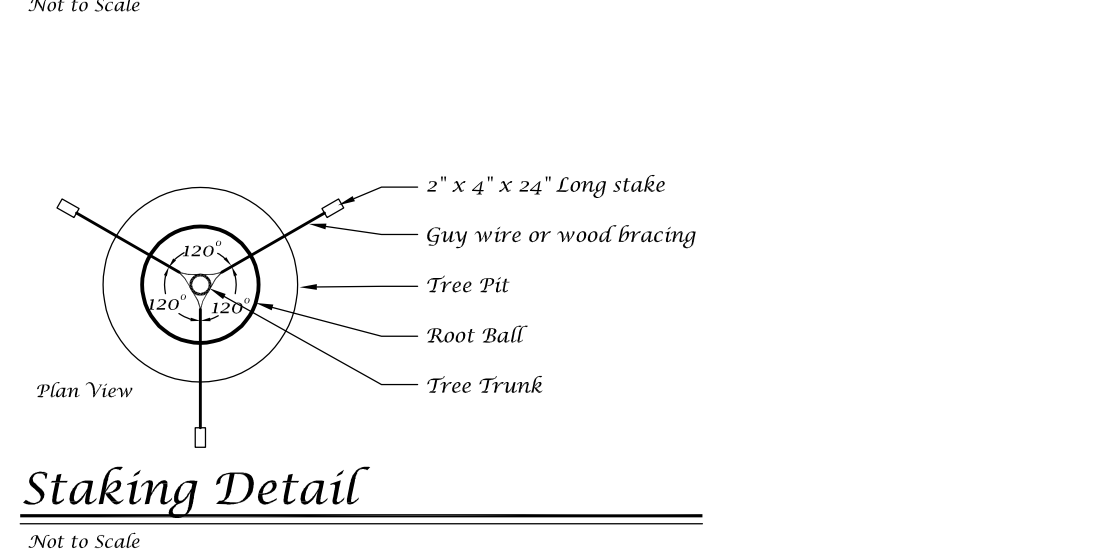

Drainage Testing Detail

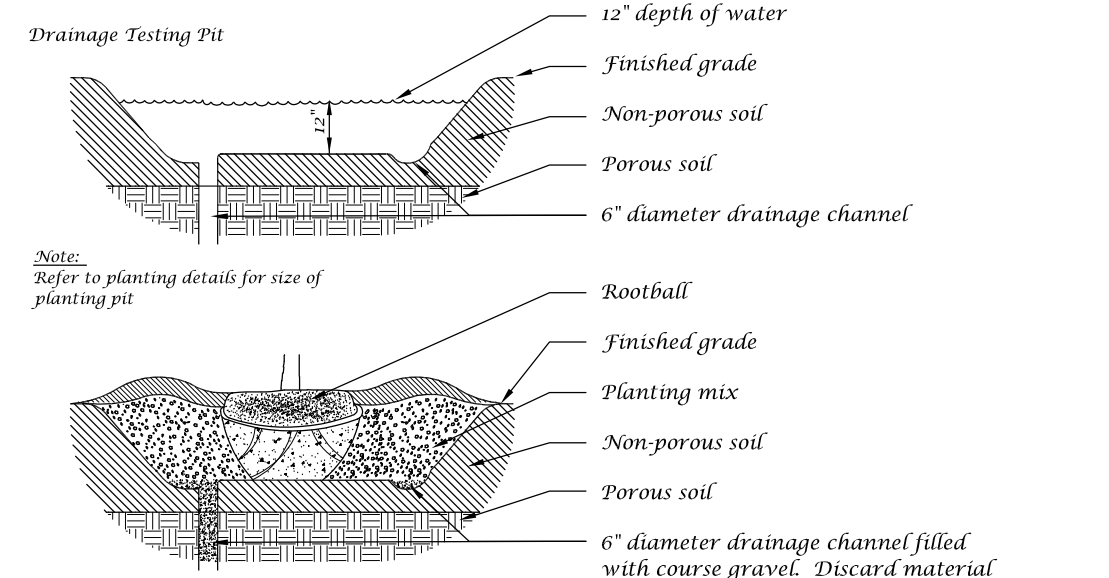

Ground Cover Detail

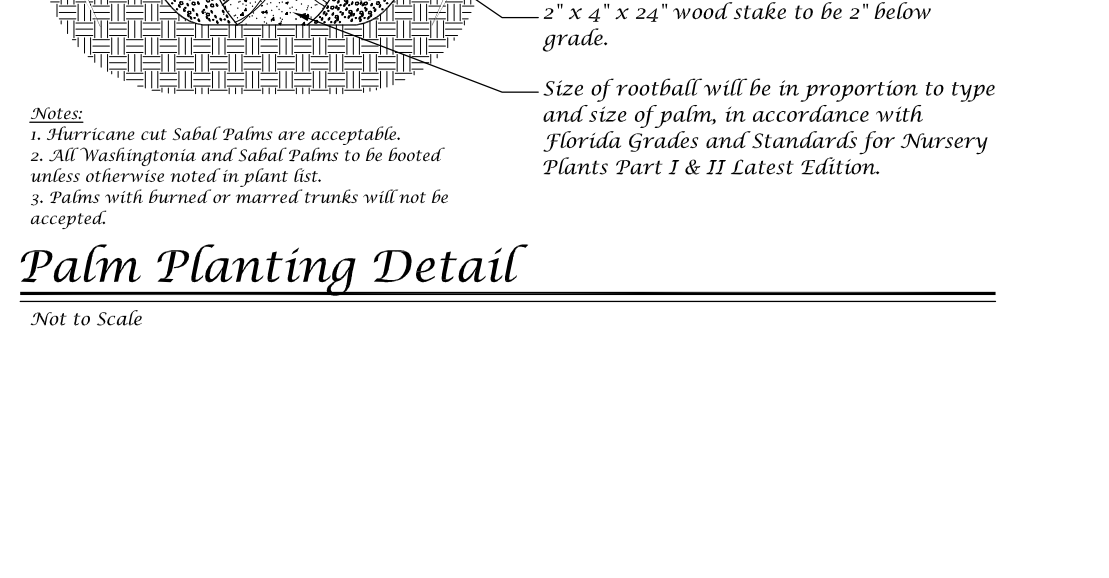
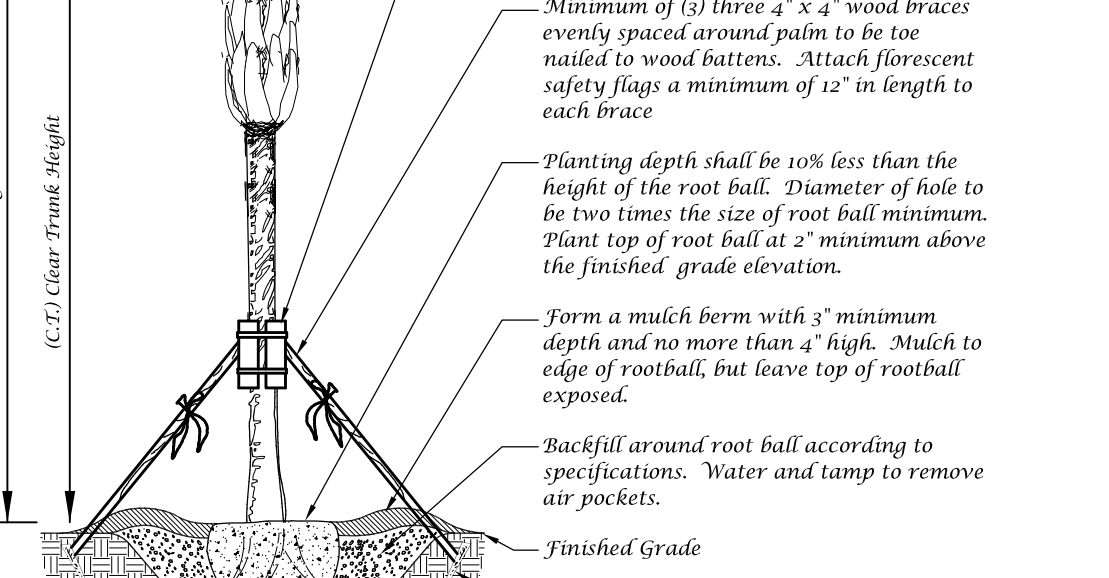
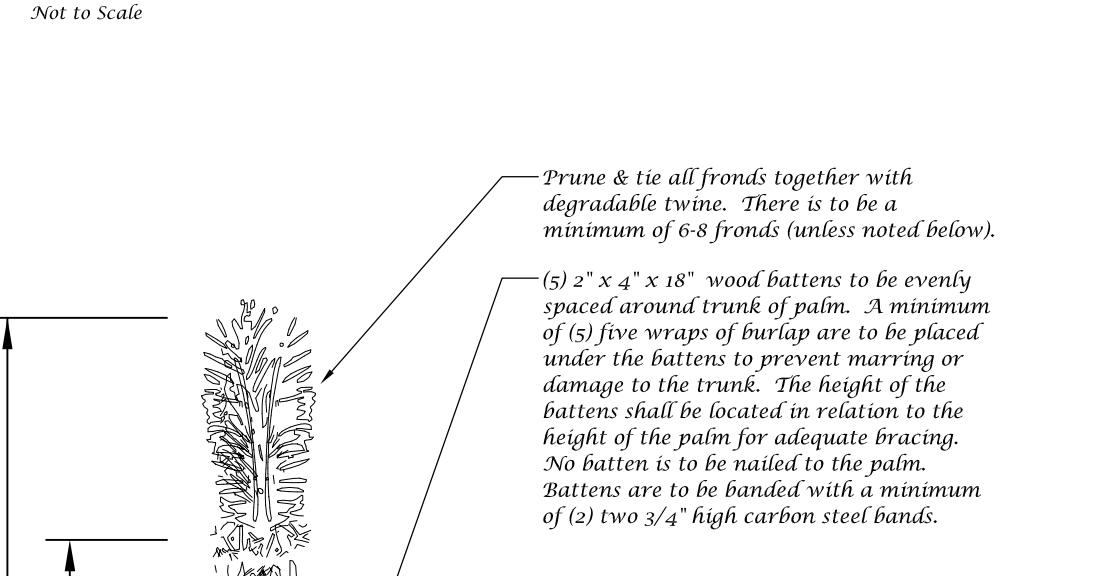

Ground Cover Detail

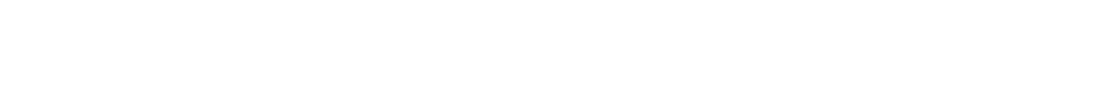

Conceptual Design Group, Inc.
Landscape Architecture - Site Planning
900 East Ocean Boulevard, Suite 1300
Stuart, Florida 34994
(772) 344-2340
LC-26000198

Flagship Storage
Jenkins Road
City of Fort Pierce, Florida

City Project Number: _____

Jeffrey W. Smith, RLA
Florida Registration Number: LA 0001635

Job No.	21-0403
Drawn By	JWS
Submitted Dates	6-30-2021
9-7-2021	9-14-2021

Revision Dates	
City Comments #1	9-7-2021
Base Update	9-14-2021

These drawings are the property of the landscape architect and are not to be used for other projects except by written permission from the landscape architect. Report any discrepancies immediately to the landscape architect.

L-2 2
Sheet of

Landscape Plan



PERSPECTIVE: SW VIEWPOINT

N.T.S.

JENKINS STORAGE
FLAGSHIP DEVELOPMENT
OKEECHOBEE CROSSINGS FORT PIERCE, FL
A-001 PERSPECTIVE VIEW 09-08-2021

ELEVEN

18

ARCHITECTURE

A WOMEN'S BUSINESS ENTERPRISE

41'-6"
38'-0"



SOUTH ELEVATION

1/16" = 1'-0"

JENKINS STORAGE
FLAGSHIP DEVELOPMENT
OKEECHOBEE CROSSINGS FORT PIERCE, FL
A-002 SOUTH ELEVATION 09-08-2021

ELEVEN

18

ARCHITECTURE

A WOMEN'S BUSINESS ENTERPRISE

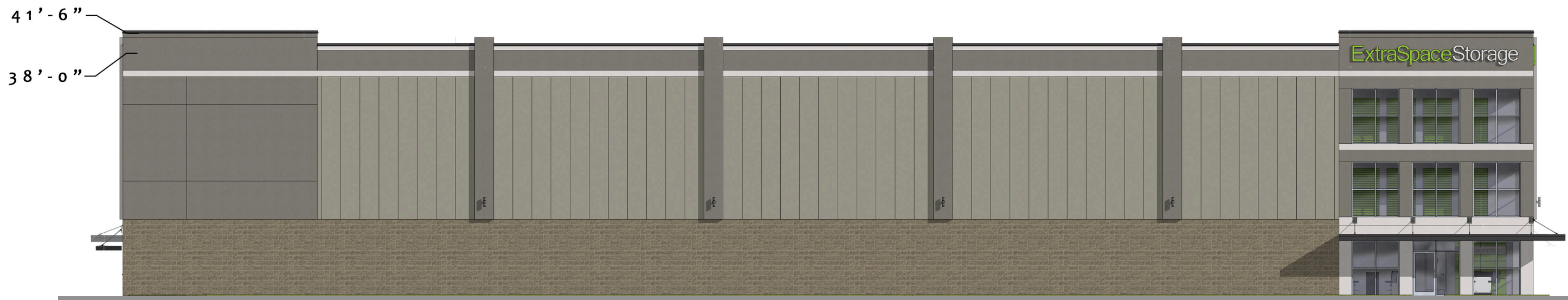

WEST ELEVATION

1/16" = 1'-0"

JENKINS STORAGE
FLAGSHIP DEVELOPMENT
OKEECHOBEE CROSSINGS FORT PIERCE, FL
A-003 WEST ELEVATION 09-08-2021

ELEVEN

18

ARCHITECTURE

A WOMEN'S BUSINESS ENTERPRISE



EAST ELEVATION

1/16" = 1'-0"

JENKINS STORAGE
FLAGSHIP DEVELOPMENT
OKEECHOBEE CROSSINGS FORT PIERCE, FL
A-004 EAST ELEVATION 09-01-2021

ELEVEN

18

ARCHITECTURE

A WOMEN'S BUSINESS ENTERPRISE

41'-6"
38'-0"



NORTH ELEVATION

1/16" = 1'-0"

JENKINS STORAGE
FLAGSHIP DEVELOPMENT
OKEECHOBEE CROSSINGS FORT PIERCE, FL
A-005 NORTH ELEVATION 09-01-2021

1. INSULATED PANEL
 - PANEL: CF ARCHITECTURAL
 - FINISH: LIGHT GRAY
2. EIFS
 - MANUFACTURER: DRYVIT
 - COLOR: 617 WINTER EVE
3. EIFS
 - MANUFACTURER: DRYVIT
 - COLOR: 613 OVERCAST
4. SPLIT FACE BLOCK
 - PAINT: CURIO GRAY- SW 0024

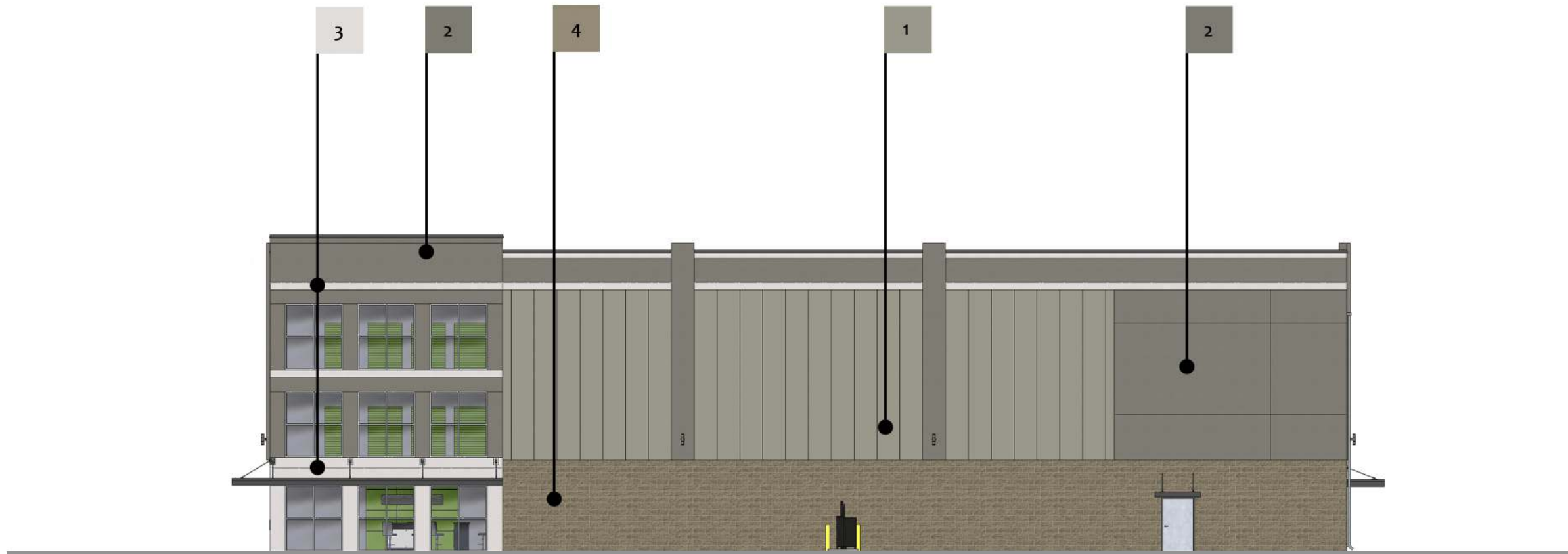

MATERIAL OUTLINE

1/16" = 1'-0"

JENKINS STORAGE
 FLAGSHIP DEVELOPMENT
 OKEECHOBEE CROSSINGS FORT PIERCE, FL
 A-006 MATERIAL OUTLINE 06-30-2021

ELEVEN
 18
 ARCHITECTURE
 A WOMEN'S BUSINESS ENTERPRISE



SOUTH ELEVATION BLDG F
NTS



WEST ELEVATION BLDG B
NTS

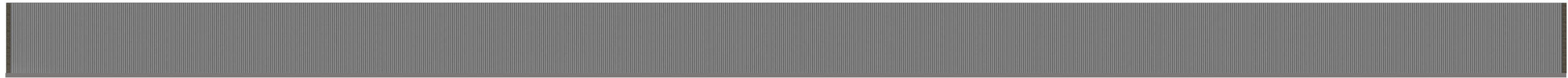

REAR ELEVATION BLDGS B-F
NTS

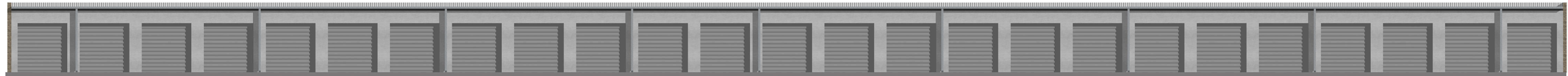

FRONT ELEVATION BLDGS B-F
NTS

JENKINS STORAGE
FLAGSHIP DEVELOPMENT
OKEECHOBEE CROSSINGS FORT PIERCE, FL
A-007 EXTERIOR STORAGE 09-15-2021



TOP OF BLOCK 6'

SPLIT FACE BLOCK,
COLOR TO MATCH
BUILDING

NVP SWING GATES
(OR EQUAL) SLATE
GRAY. VINYL MOUNT-
ED OVER GALVANIZED
FRAME

DUMPSTER ENCLOSURE
N.T.S.



RV CANOPY ELEVATION
1/16" = 1'-0"

JENKINS STORAGE
FLAGSHIP DEVELOPMENT
OKEECHOBEE CROSSINGS FORT PIERCE, FL
A-008 EXTERIOR STORAGE 06-30-2021

ELEVEN
18
ARCHITECTURE
A WOMEN'S BUSINESS ENTERPRISE



COLORED SITE PLAN

N.T.S.

**JENKINS STORAGE
 FLAGSHIP DEVELOPMENT
 OKEECHOBEE CROSSINGS FORT PIERCE, FL
 A-009 COLORED SITE PLAN 09-08-2021**



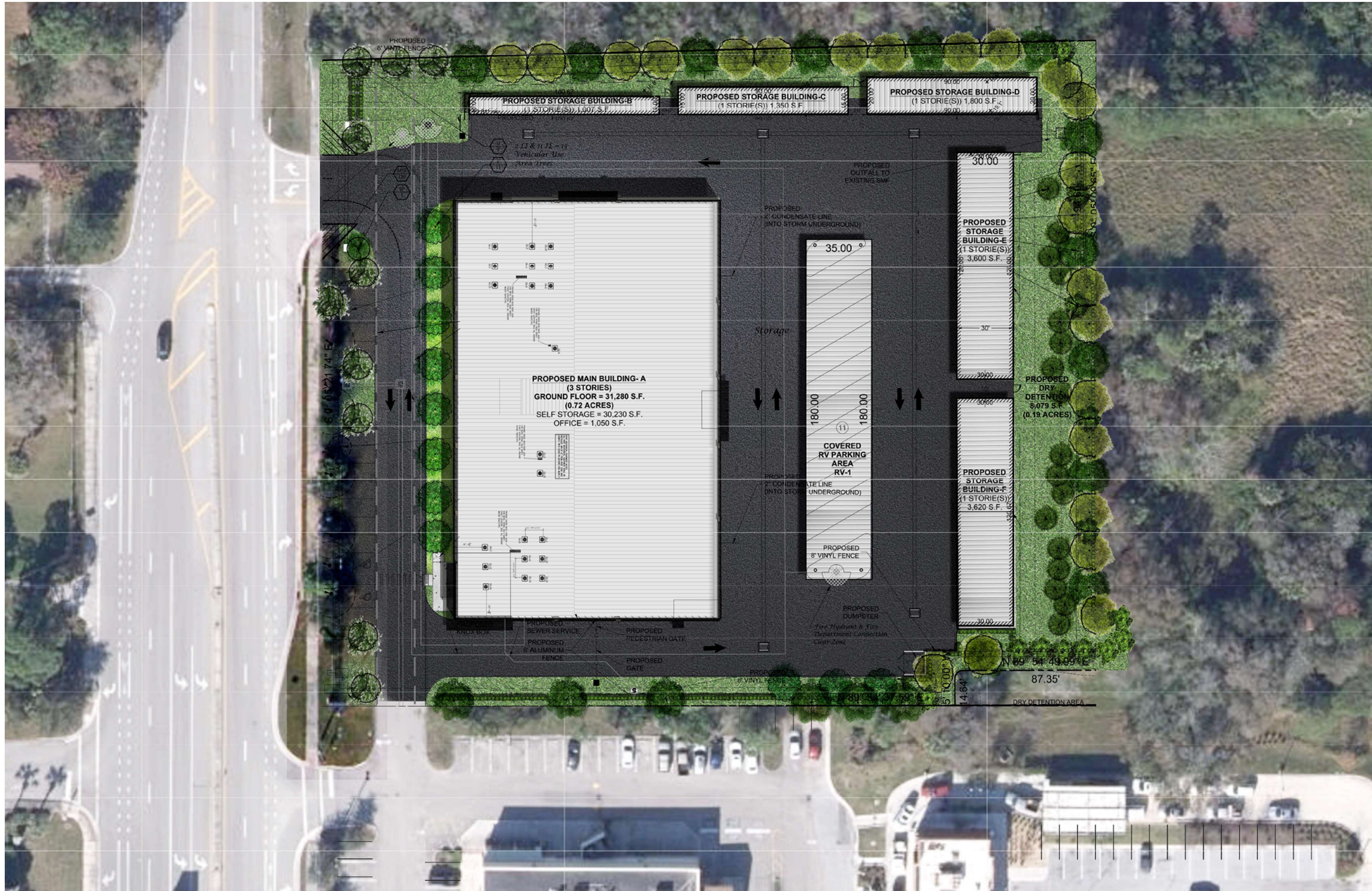

ENLARGED COLORED SITE PLAN
N.T.S.

JENKINS STORAGE
 FLAGSHIP DEVELOPMENT
 OKEECHOBEE CROSSINGS FORT PIERCE, FL
 A-010 ENLARGED COLORED SITE PLAN 09-15-2021

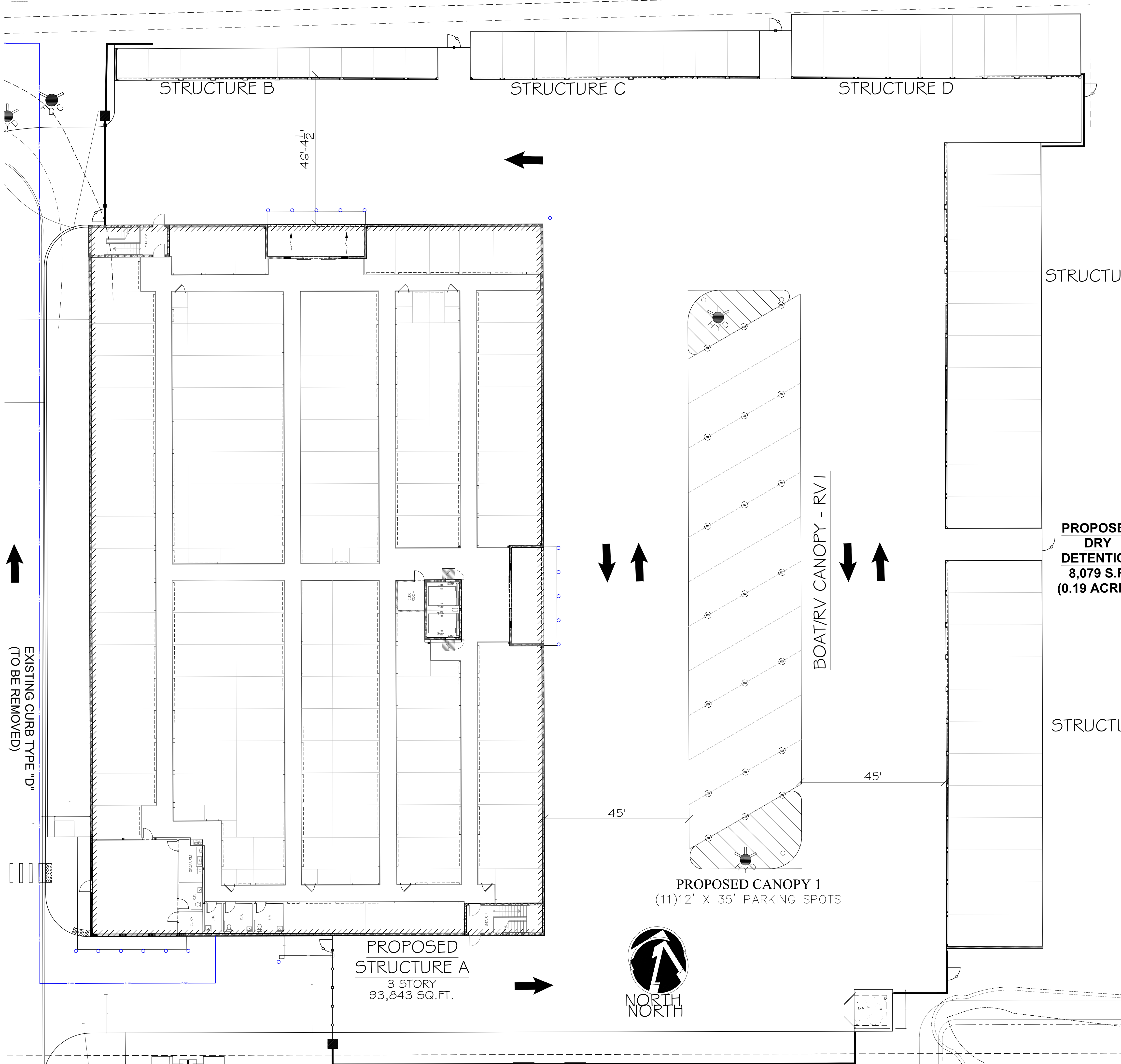

EXISTING CURB TYPE "D"
(TO BE REMOVED)

STRUCTURE B

STRUCTURE C

STRUCTURE D

46'-4 1/2"

STRUCTU

PROPOSE
DRY
DETENTIC
8,079 S.F
(0.19 ACRE)

BOAT/RV CANOPY - RV 1

STRUCTL

GC SHALL COORDINATE ALL T/CMU WALL HEIGHTS WITH RABCO ENTERPRISES, LLC PRIOR TO CONSTRUCTION TO ENSURE PROPER FIT OF THE METAL BUILDING COMPONENTS. FAILURE TO GET WRITTEN APPROVAL PRIOR TO ERECTING THE CMU WALLS MAY RESULT IN NEEDED MODIFICATIONS TO EITHER THE CMU WALL AND/OR THE METAL BUILDING COMPONENTS AT THE G.C.'S EXPENSE.

- NOTES:
- WITHOUT EXCEPTION, ALL RAINLIP, SHEETLEDGE AND BLOCKEDGE SHALL BE 1 - 1/2" DOWN FROM THE T/FINISHED FLOOR ELEVATION.
 - WITHOUT EXCEPTION, ALL DOOR THRESHOLD SHALL BE 3/4" DOWN FROM THE T/FINISHED FLOOR ELEVATION.
 - G.C. SHALL VERIFY WIDTH OF RAINLIP, SHEETLEDGE, BLOCKEDGE AND DOOR THRESHOLD WITH CONTRACT DOCUMENTS PRIOR TO FORMING SLAB EDGE.
 - IN THE ABSENCE OF RAINLIP, SHEETLEDGE, BLOCKEDGE OR DOOR THRESHOLD BEING SPECIFIED ON THE PLANS, THE G.C. SHALL VERIFY IN WRITING WITH THE STEEL CONTRACTOR THE INTENT PRIOR TO FORMING SLAB EDGE.
 - RAINLIP, SHEETLEDGE, BLOCKEDGE AND DOOR THRESHOLD ARE VITAL TO THE PROPER FIT OF THE STEEL CONSTRUCTION.
 - G.C. SHALL FIELD VERIFY THE RAINLIP, SHEETLEDGE, AND BLOCKEDGE HAVE BEEN CONSTRUCTED IN ACCORDANCE WITH CONTRACT DOCUMENTS BEFORE STEEL CONSTRUCTION BEGINS.

PROPOSED CANOPY 1
(11) 12' X 35' PARKING SPOTS

PROPOSED
STRUCTURE A
3 STORY
93,843 SQ.FT.



FINISH SCHEDULE	
ROLL - UP DOORS	
ROOF - STORAGE	
ROOF - OFFICE/ APT.	
PERIMETER PANEL	
TRIM	
DOWNSPOUTS	
PIERS & HEADERS	

* COLOR SELECTIONS MUST BE ON FILE PRIOR TO RELEASING FOR FABRICATION

MARKUPS			
#	DATE	BY	ISSUE

REVISIONS			
#	DATE	BY	ISSUE

SITE PLAN
JENKINS RD. SELF STORAGE
FORT PIERCE, FL

OWNER'S SIGNATURE: FINAL APPROVED
DATE: _____
DRAWING MANUFACTURED BY: RABCO

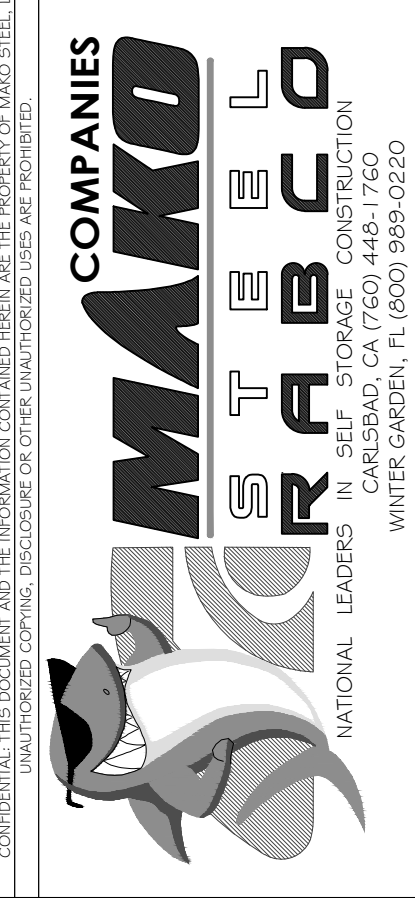

RBE CONSULTING SERVICES, LLC
1000 W. US HWY 1, SUITE 100
FORT PIERCE, FL 34941
TEL: 888-888-8888
WWW.RBECONSULTING.COM

DRAWN BY	DATE
EDJHD	08-09-21
SCALE	AS NOTED
JOB NUMBER	2475
FILE NAME	2475-STR.DWG
SHEET	

C-0-2A

Project		Catalog #		Type	
Prepared by		Notes		Date	



McGraw-Edison

GWC Galleon Wall

Wall Mount Luminaire

Typical Applications

Exterior Wall • Walkway

Interactive Menu

- Ordering Information [page 2](#)
- Product Specifications [page 2](#)
- Optical Configurations [page 3](#)
- Energy and Performance Data [page 4](#)
- Control Options [page 6](#)

Product Certifications



Quick Facts

- Choice of thirteen high-efficiency, patented AccuLED Optics™
- Downward and inverted wall mounting configurations
- Eight lumen packages from 3,215 up to 17,056
- Efficacies up to 154 lumens per watt

Connected Systems

- WaveLinx
- Enlighted

Dimensional Details

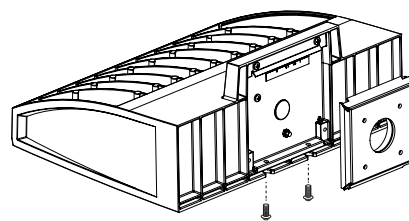
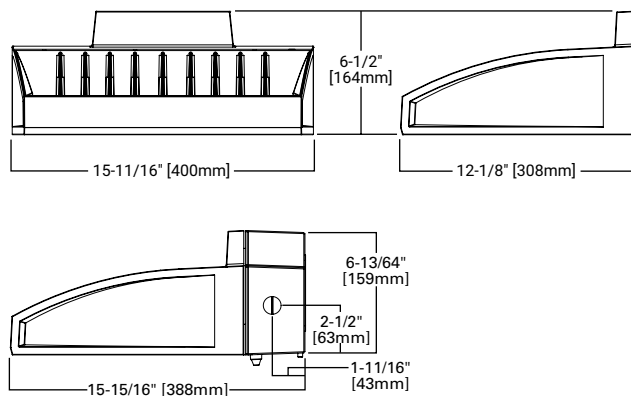

Ordering Information

SAMPLE NUMBER: GWC-SA2C-740-U-T4FT-GM

Product Family ¹	Light Engine		Color Temperature	Voltage	Distribution	Finish
	Configuration	Drive Current				
GWC=Galleon Wall	SA1=1 Square SA2=2 Squares ²	A=615mA B=800mA C=1000mA D=1200mA ⁴	722=70CRI, 2200K 727=70CRI, 2700K 730=70CRI, 3000K 735=70CRI, 3500K 740=70CRI, 4000K 750=70CRI, 5000K 760=70CRI, 6000K 827=80CRI, 2700K 830=80CRI, 3000K AMB=Amber, 590nm ^{3,4}	U=120-277V 1=120V 2=208V 3=240V 4=277V 8=480V ^{6,7} 9=347V ⁶	T2=Type II T3=Type III T4F=Type IV Forward Throw T4W=Type IV Wide SL2=Type II w/Spill Control SL3=Type III w/Spill Control SL4=Type IV w/Spill Control SLL=90° Spill Light Eliminator Left SLR=90° Spill Light Eliminator Right RW=Rectangular Wide Type I 5NQ=Type V Square Narrow 5MQ=Type V Square Medium 5WQ=Type V Square Wide	AP=Grey BZ=Bronze BK=Black DP=Dark Platinum GM=Graphite Metallic WH=White
Options (Add as Suffix)			Controls and Systems Options (Add as Suffix)		Accessories (Order Separately)	
F=Single Fused (120, 277 or 347V. Must Specify Voltage) FF=Double Fused (208, 240 or 480V. Must Specify Voltage) 10K=10kV Surge Module 20K=Series 20kV UL 1449 Surge Protective Device DIM=External 0-10V Dimming Leads ^{9,10} CBP=Battery Pack with Back Box, Cold Weather Rated ^{2,4,14,33} CBP-CEC=Battery Pack with Back Box, Cold Weather Rated, CEC compliant ^{2,4,14} L90=Optics Rotated 90° Left R90=Optics Rotated 90° Right HSS=Factory Installed House Side Shield ²³ GRSBK=Factory Installed Glare Shield, BK ^{4,27} GRSWH=Factory Installed Glare Shield, WH ^{4,27} UPL=Uplight Housing ¹³ HA=50°C High Ambient ¹² LCF=Light Square Trim Plate Painted to Match Housing ²² MT=Factory Installed Mesh Top CC=Coastal Construction finish ⁵ CE=CE Marking and Small Terminal Block ²⁴ AHD145=After Hours Dim, 5 Hours ¹⁶ AHD245=After Hours Dim, 6 Hours ¹⁶ AHD255=After Hours Dim, 7 Hours ¹⁶ AHD355=After Hours Dim, 8 Hours ¹⁶ DALI=DALI Driver ¹¹			BPC=Button Type Photocontrol (120, 208, 240 or 277V. Must Specify Voltage) PR=NEMA 3-PIN Twistlock Photocontrol Receptacle PR7=NEMA 7-PIN Twistlock Photocontrol Receptacle ¹⁵ SPB1=Dimming Occupancy Sensor with Bluetooth Interface, <8' Mounting ^{19,34} SPB2=Dimming Occupancy Sensor with Bluetooth Interface, 8' - 20' Mounting ^{19,34} SPB4=Dimming Occupancy Sensor with Bluetooth Interface, 21' - 40' Mounting ^{19,34} MS-LXX=Motion Sensor for On/Off Operation ^{17,18,19} MS/DIM-LXX=Motion Sensor for Dimming Operation ^{17,18,19} ZW=WaveLinX-enabled 4-PIN Twistlock Receptacle ^{29,30} ZD=WaveLinX Module with DALI driver and 4-PIN Receptacle ^{29,30} SWPD4XX=WaveLinX Sensor Only, 7'-15' ^{31,32} SWPD5XX=WaveLinX Sensor Only, 15'-40' ^{31,32} WOBXX=WaveLinX Sensor with Bluetooth, 7'-15' ^{31,32} WOFXX=WaveLinX Sensor with Bluetooth, 15'-40' ^{31,32} LWR-LW=Enlighted Wireless Sensor, Wide Lens for 8'-16' Mounting Height ^{19,20,21} LWR-LN=Enlighted Wireless Sensor, Narrow Lens for 16'-40' Mounting Height ^{19,20,21}		OA/RA1013=Photocontrol Shorting Cap ²⁸ OA/RA1016=NEMA Photocontrol - Multi-Tap 105-285V ²⁸ OA/RA1201=NEMA Photocontrol - 347V ²⁸ OA/RA1027=NEMA Photocontrol - 480V ²⁸ MA1252=10kV Circuit Module Replacement MA1059XX=Thru-branch Back Box (Must Specify Color) LS/HSS=Field Installed House Side Shield ^{23,25} LS/GRSBK=Glare Shield, Black ^{8,25,27} LS/GRSWH=Glare Shield, White ^{8,25,27} LS/PFS=Perimeter Shield, Black FSIR-100=Wireless Configuration Tool for Occupancy Sensor ¹⁷ WOLC-7P-10A=WaveLinX Outdoor Control Module (7-pin) ^{26,29} SWPD4-XX=WaveLinX Wireless Sensor, 7' - 15' Mounting Height ^{29,30,31,32} SWPD5-XX=WaveLinX Wireless Sensor, 15' - 40' Mounting Height ^{29,30,31,32}	
<p>NOTES:</p> <ol style="list-style-type: none"> DesignLight Consortium® Qualified. Refer to www.designlights.org, Qualified Products List under Family Models for details. Two light squares with CBP options limited to 25°C. Not available in combination with sensor options at 1200mA. Narrow-band 590nm +/- 5nm for wildlife and observatory use. Choose drive current A; supplied at 500mA drive current only. Available with 5WQ, 5MQ, SL2, SL3 and SL4 distributions. Can be used with HSS option. Not available with HA option. Coastal construction finish salt spray tested to over 5,000-hours per ASTM B117, with a scribe rating of 9 per ASTM D1654. Require the use of a step down transformer. Not available in combination with sensor options at 1200mA. 480V must use Wye system only. Per NEC, not for use with ungrounded systems, impedance grounded systems or corner grounded systems (commonly known as Three Phase Three Wire Delta, Three Phase High Leg Delta and Three Phase Corner Grounded Delta systems). Reserved. Cannot be used with other control options. Low voltage control leads extended 18" from fixture. Not available in 1200mA. When used with CBP or HA options, only available with single light square. Not available in 1200mA, UPL or CBP options. Available with single light square. Not available with SL2, SL3, SL4, HA, CBP, PR or PR7 options. Operates a single light square only. Operates at -20°C to +40°C. Backbox is non-IP rated. Control option limited to BPC. Compatible with standard 3-PIN photocontrols, 5-PIN or 7-PIN ANSI controls. Requires the use of BPC photocontrol or the PR7 or PR photocontrol receptacle with photocontrol accessory. See After Hours Dim supplemental guide for additional information. The FSIR-100 configuration tool is required to adjust parameters such as high and low modes, sensitivity, time delay and cutoff. Consult your lighting representative at Cooper Lighting Solutions for more information. Replace LXX with L08 (<8' mounting), L20 (8'-20' mounting) or L40W (21'-40' mounting.) Includes integral photosensor. Enlighted wireless sensors are factory installed requiring network components in appropriate quantities. White sensor shipped on all housing color options. Not available with HSS or GRS options. Not for use with 5NQ, 5MQ, 5WQ or RW optics. The light square trim plate is painted black when the HSS option is selected. CE is not available with the 1200, DALI, LWR, MS, MS/DIM, BPC, PR or PR7 options. Available in 120-277V only. One required for each light square. Requires PR7. Not for use with T4FT, T4W or SL4 optics. Cannot be used in conjunction with additional photocontrol or other controls systems (BPC, PR, PR7, MS, LWR). WAC Gateway required to enable field-configurability: Order WAC-PoE and WPOE-120 (10V to PoE injector) power supply if needed. Requires ZW or ZD receptacle. Replace XX with sensor color (WH, BZ, or BK). Specify 120V or 277V. Smart device with mobile application required to change system defaults. See controls section for details. 						

Product Specifications

Construction

- Driver enclosure thermally isolated from optics for optimal thermal performance
- Die-cast aluminum heat sinks
- IP66 rated housing
- 1.5G vibration rated

Optics

- Patented, high-efficiency injection-molded AccuLED Optics technology
- 13 optical distributions
- IDA Certified (3000K CCT and warmer only)

Electrical

- LED driver assembly mounted for ease of maintenance
- Standard with 0-10V dimming
- Optional 10kV or 20kV surge module
- Suitable for operation in -40C to 40C ambient environments. Optional 50C high ambient (HA) configuration.

Mounting

- Gasketed and zinc plated rigid steel mounting attachment

- "Hook-N-Lock" mechanism for easy installation

Finish

- Housing finished in super durable TGIC polyester powder coat paint, 2.5 mil nominal thickness
- Heat sink is powder coated black
- RAL and custom color matches available
- Coastal Construction (CC) option available

Warranty

- Five-year warranty

Optical Distributions

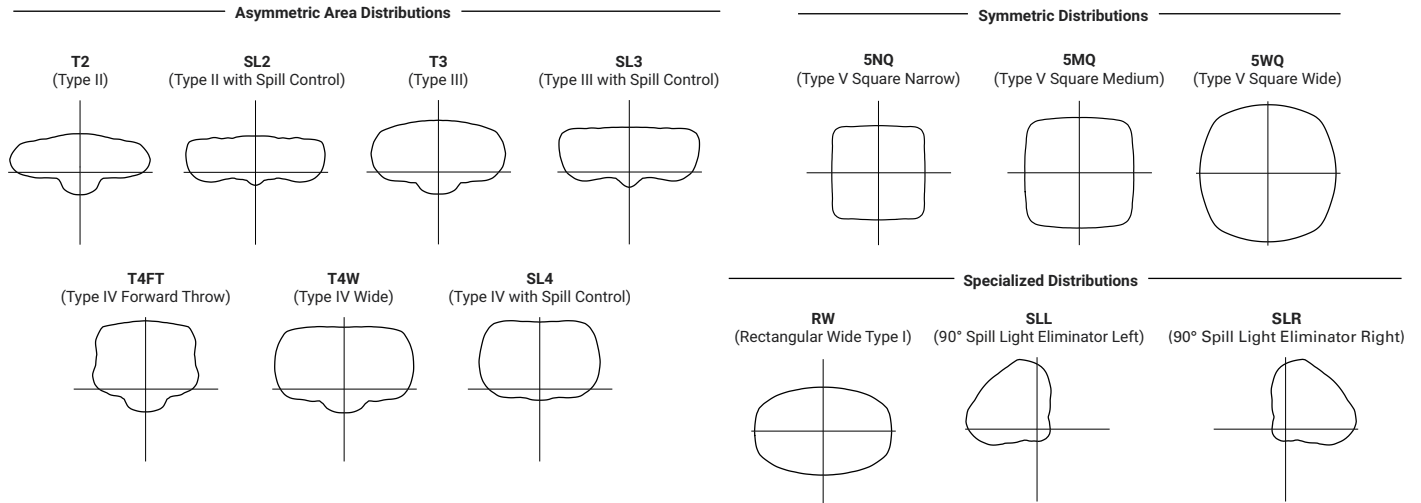

Optic Orientation

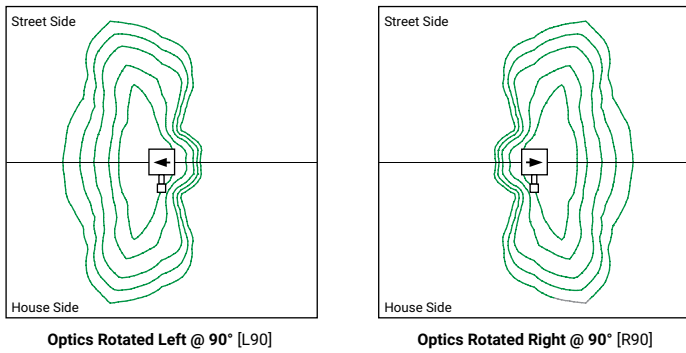

Energy and Performance Data

Lumen Multiplier

Ambient Temperature	Lumen Multiplier
0°C	1.02
10°C	1.01
25°C	1.00
40°C	0.99
50°C	0.97

Lumen Maintenance

Drive Current	Ambient Temperature	TM-21 Lumen Maintenance (60,000 Hours)	Projected L70 (Hours)
Up to 1A	Up to 50°C	> 95%	> 416,000
1.2A	Up to 40°C	> 90%	> 205,000

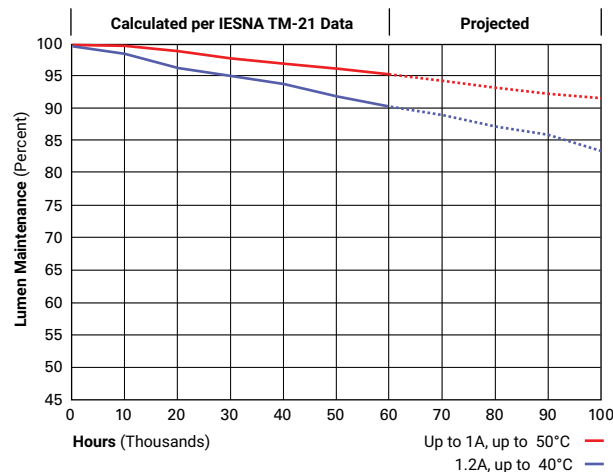

Energy and Performance Data

 View GWC Galleon Wall IES files

4000K/5000K/6000K CCT, 70 CRI

Number of Light Squares		1				2			
Drive Current		615mA	800mA	1050mA	1.2A	615mA	800mA	1050mA	1.2A
Nominal Power (Watts)		34	44	59	67	66	86	113	129
Input Current @ 120V (A)		0.30	0.39	0.51	0.58	0.58	0.77	1.02	1.16
Input Current @ 208V (A)		0.17	0.22	0.29	0.33	0.34	0.44	0.56	0.63
Input Current @ 240V (A)		0.15	0.19	0.26	0.29	0.30	0.38	0.48	0.55
Input Current @ 277V (A)		0.14	0.17	0.23	0.25	0.28	0.36	0.42	0.48
Input Current @ 347V (A)		0.11	0.15	0.17	0.20	0.19	0.24	0.32	0.39
Input Current @ 480V (A)		0.08	0.11	0.14	0.15	0.15	0.18	0.24	0.30
Optics									
T2	Lumens	4,883	5,989	7,412	8,131	9,543	11,703	14,485	15,891
	BUG Rating	B1-U0-G1	B1-U0-G2	B1-U0-G2	B1-U0-G2	B2-U0-G2	B2-U0-G2	B2-U0-G3	B2-U0-G3
	Lumens per Watt	144	136	126	121	145	136	128	123
T3	Lumens	4,978	6,105	7,556	8,288	9,729	11,929	14,764	16,196
	BUG Rating	B1-U0-G1	B1-U0-G2	B1-U0-G2	B1-U0-G2	B2-U0-G2	B2-U0-G2	B2-U0-G2	B2-U0-G3
	Lumens per Watt	146	139	128	124	147	139	131	126
T4FT	Lumens	5,008	6,140	7,599	8,337	9,783	11,998	14,850	16,290
	BUG Rating	B1-U0-G2	B1-U0-G2	B1-U0-G3	B1-U0-G3	B2-U0-G3	B2-U0-G3	B2-U0-G3	B2-U0-G3
	Lumens per Watt	147	140	129	124	148	140	131	126
T4W	Lumens	4,942	6,060	7,502	8,229	9,658	11,843	14,658	16,080
	BUG Rating	B1-U0-G2	B1-U0-G2	B1-U0-G2	B2-U0-G2	B2-U0-G2	B2-U0-G2	B2-U0-G3	B3-U0-G3
	Lumens per Watt	145	138	127	123	146	138	130	125
SL2	Lumens	4,874	5,979	7,399	8,117	9,528	11,684	14,461	15,863
	BUG Rating	B1-U0-G2	B1-U0-G2	B1-U0-G2	B2-U0-G3	B2-U0-G3	B2-U0-G3	B2-U0-G3	B3-U0-G3
	Lumens per Watt	143	136	125	121	144	136	128	123
SL3	Lumens	4,976	6,104	7,555	8,287	9,727	11,927	14,763	16,194
	BUG Rating	B1-U0-G2	B1-U0-G2	B1-U0-G2	B1-U0-G3	B1-U0-G3	B2-U0-G3	B2-U0-G3	B2-U0-G3
	Lumens per Watt	146	139	128	124	147	139	131	126
SL4	Lumens	4,729	5,799	7,178	7,873	9,239	11,333	14,025	15,387
	BUG Rating	B1-U0-G2	B1-U0-G2	B1-U0-G3	B1-U0-G3	B1-U0-G3	B1-U0-G3	B2-U0-G4	B2-U0-G4
	Lumens per Watt	139	132	122	118	140	132	124	119
5NQ	Lumens	5,134	6,296	7,793	8,547	10,033	12,303	15,226	16,704
	BUG Rating	B2-U0-G1	B2-U0-G1	B3-U0-G1	B3-U0-G1	B3-U0-G1	B3-U0-G1	B3-U0-G2	B3-U0-G2
	Lumens per Watt	151	143	132	128	152	143	135	129
5MQ	Lumens	5,228	6,412	7,935	8,705	10,216	12,529	15,508	17,011
	BUG Rating	B3-U0-G1	B3-U0-G1	B3-U0-G2	B3-U0-G2	B3-U0-G2	B4-U0-G2	B4-U0-G2	B4-U0-G2
	Lumens per Watt	154	146	134	130	155	146	137	132
5WQ	Lumens	5,242	6,428	7,956	8,728	10,244	12,563	15,548	17,056
	BUG Rating	B3-U0-G1	B3-U0-G2	B3-U0-G2	B3-U0-G2	B4-U0-G2	B4-U0-G2	B4-U0-G2	B4-U0-G2
	Lumens per Watt	154	146	135	130	155	146	138	132
SLL/SLR	Lumens	4,373	5,365	6,640	7,283	8,547	10,481	12,973	14,231
	BUG Rating	B1-U0-G2	B1-U0-G2	B1-U0-G2	B1-U0-G3	B1-U0-G3	B2-U0-G3	B2-U0-G3	B2-U0-G3
	Lumens per Watt	129	122	113	109	130	122	115	110
RW	Lumens	5,087	6,238	7,721	8,472	9,941	12,190	15,088	16,553
	BUG Rating	B2-U0-G1	B3-U0-G1	B3-U0-G1	B3-U0-G1	B3-U0-G1	B3-U0-G2	B4-U0-G2	B4-U0-G2
	Lumens per Watt	150	142	131	126	151	142	134	128

* Nominal lumen data for 70 CRI. BUG rating for 4000K/5000K. Refer to IES files for 3000K BUG ratings.

3000K CCT, 80 CRI

Number of Light Squares		1				2			
Drive Current		615mA	800mA	1050mA	1.2A	615mA	800mA	1050mA	1.2A
Nominal Power (Watts)		34	44	59	67	66	86	113	129
Input Current @ 120V (A)		0.30	0.39	0.51	0.58	0.58	0.77	1.02	1.16
Input Current @ 208V (A)		0.17	0.22	0.29	0.33	0.34	0.44	0.56	0.63
Input Current @ 240V (A)		0.15	0.19	0.26	0.29	0.30	0.38	0.48	0.55
Input Current @ 277V (A)		0.14	0.17	0.23	0.25	0.28	0.36	0.42	0.48
Input Current @ 347V (A)		0.11	0.15	0.17	0.20	0.19	0.24	0.32	0.39
Input Current @ 480V (A)		0.08	0.11	0.14	0.15	0.15	0.18	0.24	0.30
Optics									
T2	Lumens	3,880	4,759	5,890	6,461	7,583	9,300	11,510	12,628
	BUG Rating	B1-U0-G1	B1-U0-G1	B1-U0-G2	B1-U0-G2	B1-U0-G2	B1-U0-G2	B2-U0-G2	B2-U0-G3
	Lumens per Watt	114	108	100	96	115	108	102	98
T3	Lumens	3,956	4,851	6,004	6,586	7,731	9,479	11,732	12,870
	BUG Rating	B1-U0-G1	B1-U0-G1	B1-U0-G2	B1-U0-G2	B1-U0-G2	B2-U0-G2	B2-U0-G2	B2-U0-G2
	Lumens per Watt	116	110	102	98	117	110	104	100
T4FT	Lumens	3,980	4,879	6,038	6,625	7,774	9,534	11,800	12,945
	BUG Rating	B1-U0-G2	B1-U0-G2	B1-U0-G2	B1-U0-G2	B1-U0-G3	B2-U0-G3	B2-U0-G3	B2-U0-G3
	Lumens per Watt	117	111	102	99	118	111	104	100
T4W	Lumens	3,927	4,816	5,961	6,539	7,675	9,411	11,648	12,778
	BUG Rating	B1-U0-G1	B1-U0-G2	B1-U0-G2	B1-U0-G2	B2-U0-G2	B2-U0-G2	B2-U0-G2	B2-U0-G3
	Lumens per Watt	116	109	101	98	116	109	103	99
SL2	Lumens	3,873	4,751	5,880	6,450	7,571	9,285	11,491	12,605
	BUG Rating	B1-U0-G2	B1-U0-G2	B1-U0-G2	B1-U0-G2	B1-U0-G3	B2-U0-G3	B2-U0-G3	B2-U0-G3
	Lumens per Watt	114	108	100	96	115	108	102	98
SL3	Lumens	3,954	4,851	6,004	6,585	7,729	9,478	11,731	12,868
	BUG Rating	B1-U0-G2	B1-U0-G2	B1-U0-G2	B1-U0-G2	B1-U0-G2	B1-U0-G3	B2-U0-G3	B2-U0-G3
	Lumens per Watt	116	110	102	98	117	110	104	100
SL4	Lumens	3,758	4,608	5,704	6,256	7,342	9,006	11,145	12,227
	BUG Rating	B1-U0-G2	B1-U0-G2	B1-U0-G2	B1-U0-G3	B1-U0-G3	B1-U0-G3	B1-U0-G3	B1-U0-G3
	Lumens per Watt	111	105	97	93	111	105	99	95
5NQ	Lumens	4,080	5,003	6,193	6,792	7,973	9,776	12,099	13,274
	BUG Rating	B2-U0-G0	B2-U0-G1	B2-U0-G1	B2-U0-G1	B3-U0-G1	B3-U0-G1	B3-U0-G1	B3-U0-G2
	Lumens per Watt	120	114	105	101	121	114	107	103
5MQ	Lumens	4,154	5,095	6,305	6,917	8,118	9,956	12,323	13,518
	BUG Rating	B2-U0-G1	B3-U0-G1	B3-U0-G1	B3-U0-G1	B3-U0-G2	B3-U0-G2	B4-U0-G2	B4-U0-G2
	Lumens per Watt	122	116	107	103	123	116	109	105
5WQ	Lumens	4,166	5,108	6,322	6,936	8,140	9,983	12,355	13,553
	BUG Rating	B3-U0-G1	B3-U0-G1	B3-U0-G1	B3-U0-G2	B3-U0-G2	B4-U0-G2	B4-U0-G2	B4-U0-G2
	Lumens per Watt	123	116	107	104	123	116	109	105
SLL/SLR	Lumens	3,475	4,263	5,276	5,787	6,792	8,329	10,309	11,309
	BUG Rating	B1-U0-G2	B1-U0-G2	B1-U0-G2	B1-U0-G2	B1-U0-G3	B1-U0-G3	B2-U0-G3	B2-U0-G3
	Lumens per Watt	102	97	89	86	103	97	91	88
RW	Lumens	4,042	4,957	6,135	6,732	7,900	9,687	11,990	13,154
	BUG Rating	B2-U0-G1	B2-U0-G1	B3-U0-G1	B3-U0-G1	B3-U0-G1	B3-U0-G1	B3-U0-G2	B3-U0-G2
	Lumens per Watt	119	113	104	100	120	113	106	102

* Nominal lumen data for 70 CRI. BUG rating for 4000K/5000K. Refer to IES files for 3000K BUG ratings.

Control Options

0-10V This fixture is offered standard with 0-10V dimming driver(s). The DIM option provides 0-10V dimming wire leads for use with a lighting control panel or other control method.

Photocontrol (BPC, PR, and PR7) Optional button-type photocontrol (BPC) and photocontrol receptacles (PR and PR7) provide a flexible solution to enable “dusk-to-dawn” lighting by sensing light levels. Advanced control systems compatible with NEMA 7-pin standards can be utilized with the PR7 receptacle.

After Hours Dim (AHD) This feature allows photocontrol-enabled luminaires to achieve additional energy savings by dimming during scheduled portions of the night. The dimming profile will automatically take effect after a “dusk-to-dawn” period has been calculated from the photocontrol input. Specify the desired dimming profile for a simple, factory-shipped dimming solution requiring no external control wiring. Reference the After Hours Dim supplemental guide for additional information.

Dimming Occupancy Sensor (SPB, MS/DIM-LXX and MS-LXX) These sensors are factory installed in the luminaire housing. When the SPB or MS/DIM sensor options are selected, the occupancy sensor is connected to a dimming driver and the entire luminaire dims when there is no activity detected. When activity is detected, the luminaire returns to full light output. The MS/DIM sensor is factory preset to dim down to approximately 50 percent power with a time delay of five minutes. The MS-LXX sensor is factory preset to turn the luminaire off after five minutes of no activity. SPB motion sensors require the Sensor Configuration mobile application by Wattstopper to change factory default dimming level, time delay, sensitivity and other parameters. Available for iOS and Android devices. The SPB sensor is factory preset to dim down to approximately 10% power with a time delay of five minutes. The MS/DIM occupancy sensors require the FSIR-100 programming tool to adjust factory defaults.

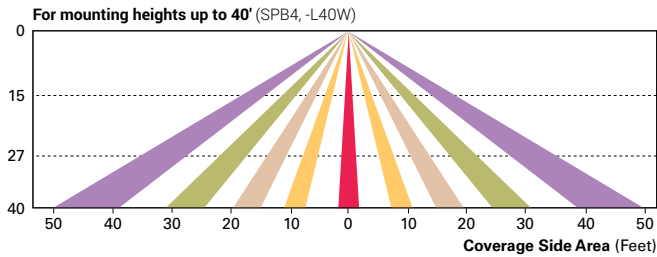
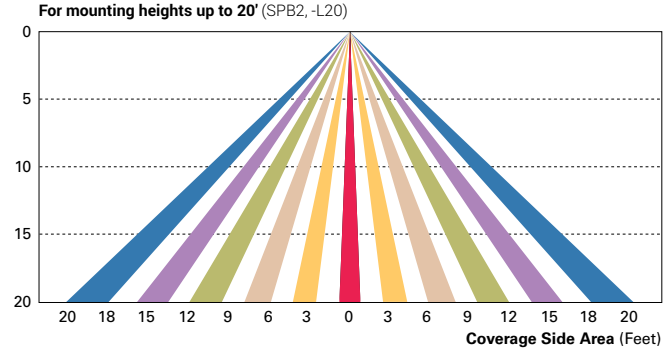
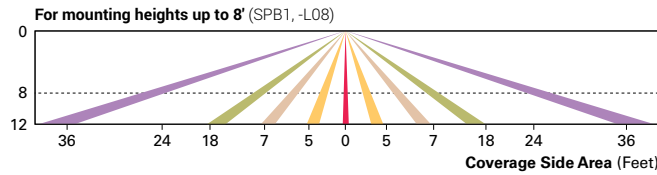

Enlighted Wireless Control and Monitoring System (LWR-LW and LWR-LN) The Enlighted control system is a connected lighting solution, combining LED luminaires with an integrated wireless sensor system. The sensor controls the lighting system in compliance with the latest energy codes while collecting valuable data about building performance and use. Software applications utilizing energy dashboards maximize data inputs to help optimize the use of other resources beyond lighting.

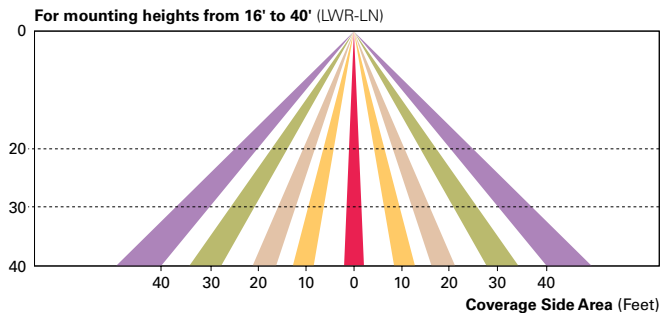
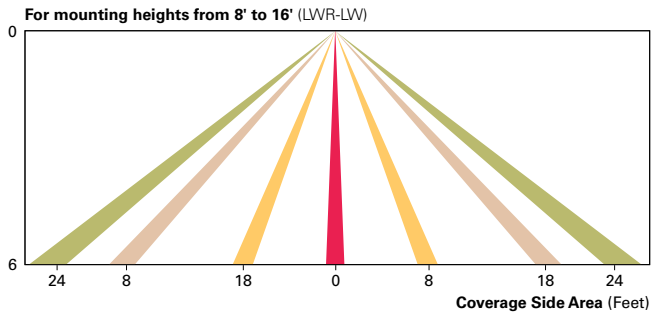

WaveLinx Wireless Outdoor Lighting Control Module (WOLC-7P-10A) The 7-pin wireless outdoor lighting control module enables WaveLinx to control outdoor area, site and flood lighting. WaveLinx controls outdoor lighting using schedules to provide ON, OFF and dimming controls based on astronomic or time schedules based on a 7 day week.

Project		Catalog #		Type	
Prepared by		Notes		Date	



McGraw-Edison

GWC Galleon Wall

Wall Mount Luminaire

Typical Applications

Exterior Wall • Walkway

Interactive Menu

- Ordering Information [page 2](#)
- Product Specifications [page 2](#)
- Optical Configurations [page 3](#)
- Energy and Performance Data [page 4](#)
- Control Options [page 6](#)

Product Certifications



Quick Facts

- Choice of thirteen high-efficiency, patented AccuLED Optics™
- Downward and inverted wall mounting configurations
- Eight lumen packages from 3,215 up to 17,056
- Efficacies up to 154 lumens per watt

Connected Systems

- WaveLinx
- Enlighted

Dimensional Details

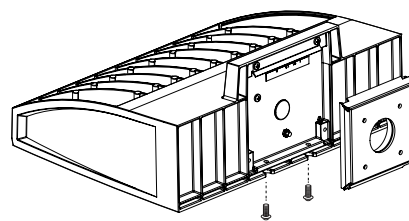
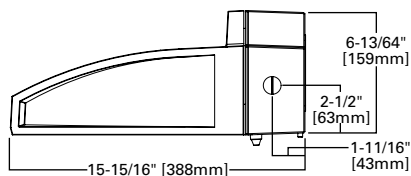
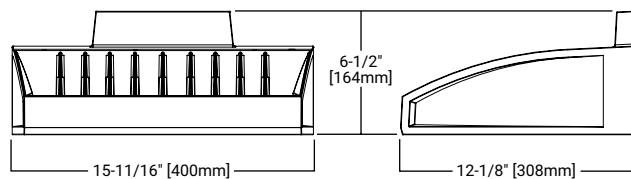

Ordering Information

SAMPLE NUMBER: GWC-SA2C-740-U-T4FT-GM

Product Family ¹	Light Engine		Color Temperature	Voltage	Distribution	Finish
	Configuration	Drive Current				
GWC=Galleon Wall	SA1=1 Square SA2=2 Squares ²	A=615mA B=800mA C=1000mA D=1200mA ⁴	722=70CRI, 2200K 727=70CRI, 2700K 730=70CRI, 3000K 735=70CRI, 3500K 740=70CRI, 4000K 750=70CRI, 5000K 760=70CRI, 6000K 827=80CRI, 2700K 830=80CRI, 3000K AMB=Amber, 590nm ^{3,4}	U=120-277V 1=120V 2=208V 3=240V 4=277V 8=480V ^{6,7} 9=347V ⁶	T2=Type II T3=Type III T4F=Type IV Forward Throw T4W=Type IV Wide SL2=Type II w/Spill Control SL3=Type III w/Spill Control SL4=Type IV w/Spill Control SLL=90° Spill Light Eliminator Left SLR=90° Spill Light Eliminator Right RW=Rectangular Wide Type I 5NQ=Type V Square Narrow 5MQ=Type V Square Medium 5WQ=Type V Square Wide	AP=Grey BZ=Bronze BK=Black DP=Dark Platinum GM=Graphite Metallic WH=White
Options (Add as Suffix)			Controls and Systems Options (Add as Suffix)		Accessories (Order Separately)	
F=Single Fused (120, 277 or 347V. Must Specify Voltage) FF=Double Fused (208, 240 or 480V. Must Specify Voltage) 10K=10kV Surge Module 20K=Series 20kV UL 1449 Surge Protective Device DIM=External 0-10V Dimming Leads ^{9,10} CBP=Battery Pack with Back Box, Cold Weather Rated ^{2,4,14,33} CBP-CEC=Battery Pack with Back Box, Cold Weather Rated, CEC compliant ^{2,4,14} L90=Optics Rotated 90° Left R90=Optics Rotated 90° Right HSS=Factory Installed House Side Shield ²³ GRSBK=Factory Installed Glare Shield, BK ^{4,27} GRSWH=Factory Installed Glare Shield, WH ^{4,27} UPL=Uplight Housing ¹³ HA=50°C High Ambient ¹² LCF=Light Square Trim Plate Painted to Match Housing ²² MT=Factory Installed Mesh Top CC=Coastal Construction finish ⁵ CE=CE Marking and Small Terminal Block ²⁴ AHD145=After Hours Dim, 5 Hours ¹⁶ AHD245=After Hours Dim, 6 Hours ¹⁶ AHD255=After Hours Dim, 7 Hours ¹⁶ AHD355=After Hours Dim, 8 Hours ¹⁶ DALI=DALI Driver ¹¹			BPC=Button Type Photocontrol (120, 208, 240 or 277V. Must Specify Voltage) PR=NEMA 3-PIN Twistlock Photocontrol Receptacle PR7=NEMA 7-PIN Twistlock Photocontrol Receptacle ¹⁵ SPB1=Dimming Occupancy Sensor with Bluetooth Interface, <8' Mounting ^{19,34} SPB2=Dimming Occupancy Sensor with Bluetooth Interface, 8' - 20' Mounting ^{19,34} SPB4=Dimming Occupancy Sensor with Bluetooth Interface, 21' - 40' Mounting ^{19,34} MS-LXX=Motion Sensor for On/Off Operation ^{17,18,19} MS/DIM-LXX=Motion Sensor for Dimming Operation ^{17,18,19} ZW=WaveLinX-enabled 4-PIN Twistlock Receptacle ^{29,30} ZD=WaveLinX Module with DALI driver and 4-PIN Receptacle ^{29,30} SWPD4XX=WaveLinX Sensor Only, 7' - 15' ^{31,32} SWPD5XX=WaveLinX Sensor Only, 15' - 40' ^{31,32} WOBXX=WaveLinX Sensor with Bluetooth, 7' - 15' ^{31,32} WOFXX=WaveLinX Sensor with Bluetooth, 15' - 40' ^{31,32} LWR-LW=Enlighted Wireless Sensor, Wide Lens for 8'-16' Mounting Height ^{19,20,21} LWR-LN=Enlighted Wireless Sensor, Narrow Lens for 16'-40' Mounting Height ^{19,20,21}		OA/RA1013=Photocontrol Shorting Cap ²⁸ OA/RA1016=NEMA Photocontrol - Multi-Tap 105-285V ²⁸ OA/RA1201=NEMA Photocontrol - 347V ²⁸ OA/RA1027=NEMA Photocontrol - 480V ²⁸ MA1252=10kV Circuit Module Replacement MA1059XX=Thru-branch Back Box (Must Specify Color) LS/HSS=Field Installed House Side Shield ^{23,25} LS/GRSBK=Glare Shield, Black ^{8,25,27} LS/GRSWH=Glare Shield, White ^{8,25,27} LS/PFS=Perimeter Shield, Black FSIR-100=Wireless Configuration Tool for Occupancy Sensor ¹⁷ WOLC-7P-10A=WaveLinX Outdoor Control Module (7-pin) ^{26,29} SWPD4-XX=WaveLinX Wireless Sensor, 7' - 15' Mounting Height ^{29,30,31,32} SWPD5-XX=WaveLinX Wireless Sensor, 15' - 40' Mounting Height ^{29,30,31,32}	
<p>NOTES:</p> <ol style="list-style-type: none"> DesignLight Consortium® Qualified. Refer to www.designlights.org, Qualified Products List under Family Models for details. Two light squares with CBP options limited to 25°C. Not available in combination with sensor options at 1200mA. Narrow-band 590nm +/- 5nm for wildlife and observatory use. Choose drive current A; supplied at 500mA drive current only. Available with 5WQ, 5MQ, SL2, SL3 and SL4 distributions. Can be used with HSS option. Not available with HA option. Coastal construction finish salt spray tested to over 5,000-hours per ASTM B117, with a scribe rating of 9 per ASTM D1654. Require the use of a step down transformer. Not available in combination with sensor options at 1200mA. 480V must use Wye system only. Per NEC, not for use with ungrounded systems, impedance grounded systems or corner grounded systems (commonly known as Three Phase Three Wire Delta, Three Phase High Leg Delta and Three Phase Corner Grounded Delta systems). Reserved. Cannot be used with other control options. Low voltage control leads extended 18" from fixture. Not available in 1200mA. When used with CBP or HA options, only available with single light square. Not available in 1200mA, UPL or CBP options. Available with single light square. Not available with SL2, SL3, SL4, HA, CBP, PR or PR7 options. Operates a single light square only. Operates at -20°C to +40°C. Backbox is non-IP rated. Control option limited to BPC. Compatible with standard 3-PIN photocontrols, 5-PIN or 7-PIN ANSI controls. Requires the use of BPC photocontrol or the PR7 or PR photocontrol receptacle with photocontrol accessory. See After Hours Dim supplemental guide for additional information. The FSIR-100 configuration tool is required to adjust parameters such as high and low modes, sensitivity, time delay and cutoff. Consult your lighting representative at Cooper Lighting Solutions for more information. Replace LXX with L08 (<8' mounting), L20 (8'-20' mounting) or L40W (21'-40' mounting.) Includes integral photosensor. Enlighted wireless sensors are factory installed requiring network components in appropriate quantities. White sensor shipped on all housing color options. Not available with HSS or GRS options. Not for use with 5NQ, 5MQ, 5WQ or RW optics. The light square trim plate is painted black when the HSS option is selected. CE is not available with the 1200, DALI, LWR, MS, MS/DIM, BPC, PR or PR7 options. Available in 120-277V only. One required for each light square. Requires PR7. Not for use with T4FT, T4W or SL4 optics. Cannot be used in conjunction with additional photocontrol or other controls systems (BPC, PR, PR7, MS, LWR). WAC Gateway required to enable field-configurability: Order WAC-PoE and WPOE-120 (10V to PoE injector) power supply if needed. Requires ZW or ZD receptacle. Replace XX with sensor color (WH, BZ, or BK). Specify 120V or 277V. Smart device with mobile application required to change system defaults. See controls section for details. 						

Product Specifications

Construction

- Driver enclosure thermally isolated from optics for optimal thermal performance
- Die-cast aluminum heat sinks
- IP66 rated housing
- 1.5G vibration rated

Optics

- Patented, high-efficiency injection-molded AccuLED Optics technology
- 13 optical distributions
- IDA Certified (3000K CCT and warmer only)

Electrical

- LED driver assembly mounted for ease of maintenance
- Standard with 0-10V dimming
- Optional 10kV or 20kV surge module
- Suitable for operation in -40C to 40C ambient environments. Optional 50C high ambient (HA) configuration.

Mounting

- Gasketed and zinc plated rigid steel mounting attachment

- "Hook-N-Lock" mechanism for easy installation

Finish

- Housing finished in super durable TGIC polyester powder coat paint, 2.5 mil nominal thickness
- Heat sink is powder coated black
- RAL and custom color matches available
- Coastal Construction (CC) option available

Warranty

- Five-year warranty

Optical Distributions

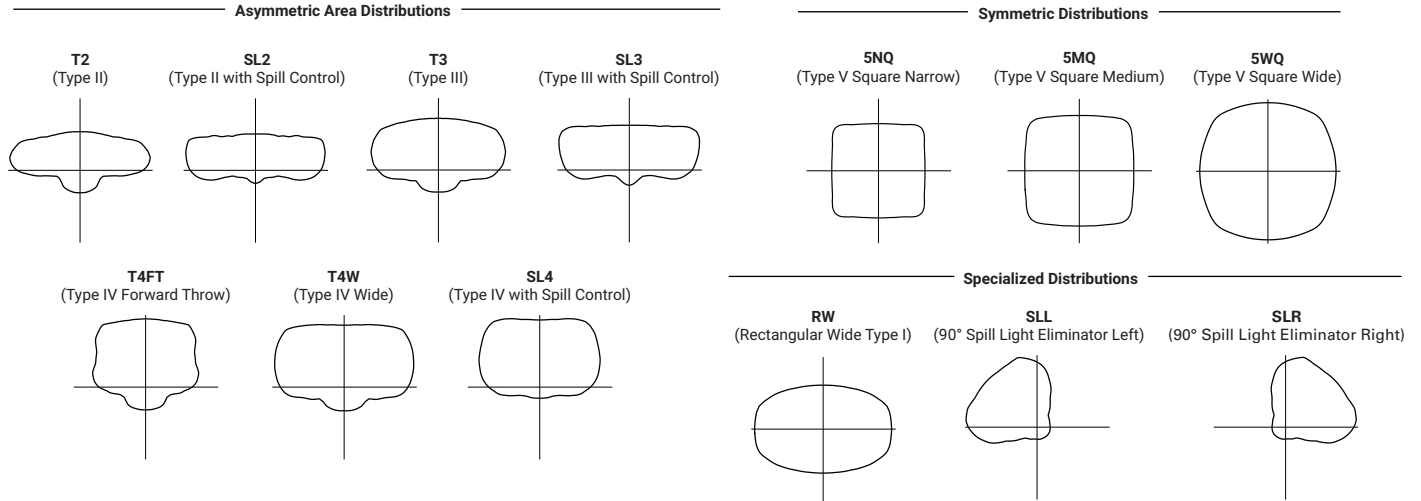

Optic Orientation

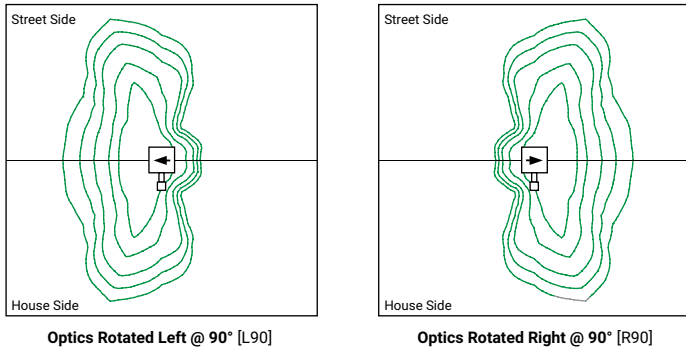

Energy and Performance Data

Lumen Multiplier

Ambient Temperature	Lumen Multiplier
0°C	1.02
10°C	1.01
25°C	1.00
40°C	0.99
50°C	0.97

Lumen Maintenance

Drive Current	Ambient Temperature	TM-21 Lumen Maintenance (60,000 Hours)	Projected L70 (Hours)
Up to 1A	Up to 50°C	> 95%	> 416,000
1.2A	Up to 40°C	> 90%	> 205,000

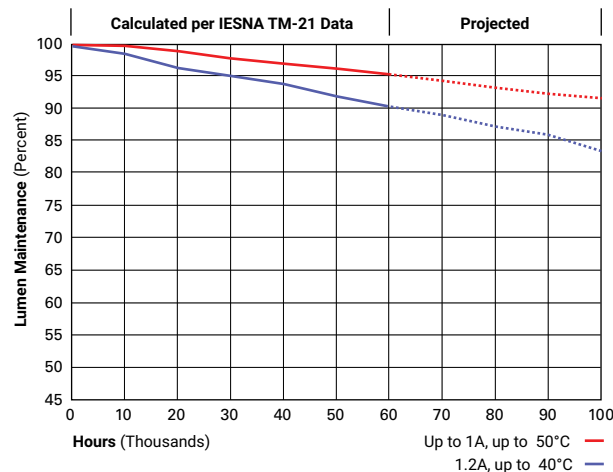

Energy and Performance Data

 View GWC Galleon Wall IES files

4000K/5000K/6000K CCT, 70 CRI

Number of Light Squares		1				2			
Drive Current		615mA	800mA	1050mA	1.2A	615mA	800mA	1050mA	1.2A
Nominal Power (Watts)		34	44	59	67	66	86	113	129
Input Current @ 120V (A)		0.30	0.39	0.51	0.58	0.58	0.77	1.02	1.16
Input Current @ 208V (A)		0.17	0.22	0.29	0.33	0.34	0.44	0.56	0.63
Input Current @ 240V (A)		0.15	0.19	0.26	0.29	0.30	0.38	0.48	0.55
Input Current @ 277V (A)		0.14	0.17	0.23	0.25	0.28	0.36	0.42	0.48
Input Current @ 347V (A)		0.11	0.15	0.17	0.20	0.19	0.24	0.32	0.39
Input Current @ 480V (A)		0.08	0.11	0.14	0.15	0.15	0.18	0.24	0.30
Optics									
T2	Lumens	4,883	5,989	7,412	8,131	9,543	11,703	14,485	15,891
	BUG Rating	B1-U0-G1	B1-U0-G2	B1-U0-G2	B1-U0-G2	B2-U0-G2	B2-U0-G2	B2-U0-G3	B2-U0-G3
	Lumens per Watt	144	136	126	121	145	136	128	123
T3	Lumens	4,978	6,105	7,556	8,288	9,729	11,929	14,764	16,196
	BUG Rating	B1-U0-G1	B1-U0-G2	B1-U0-G2	B1-U0-G2	B2-U0-G2	B2-U0-G2	B2-U0-G2	B2-U0-G3
	Lumens per Watt	146	139	128	124	147	139	131	126
T4FT	Lumens	5,008	6,140	7,599	8,337	9,783	11,998	14,850	16,290
	BUG Rating	B1-U0-G2	B1-U0-G2	B1-U0-G3	B1-U0-G3	B2-U0-G3	B2-U0-G3	B2-U0-G3	B2-U0-G3
	Lumens per Watt	147	140	129	124	148	140	131	126
T4W	Lumens	4,942	6,060	7,502	8,229	9,658	11,843	14,658	16,080
	BUG Rating	B1-U0-G2	B1-U0-G2	B1-U0-G2	B2-U0-G2	B2-U0-G2	B2-U0-G2	B2-U0-G3	B3-U0-G3
	Lumens per Watt	145	138	127	123	146	138	130	125
SL2	Lumens	4,874	5,979	7,399	8,117	9,528	11,684	14,461	15,863
	BUG Rating	B1-U0-G2	B1-U0-G2	B1-U0-G2	B2-U0-G3	B2-U0-G3	B2-U0-G3	B2-U0-G3	B3-U0-G3
	Lumens per Watt	143	136	125	121	144	136	128	123
SL3	Lumens	4,976	6,104	7,555	8,287	9,727	11,927	14,763	16,194
	BUG Rating	B1-U0-G2	B1-U0-G2	B1-U0-G2	B1-U0-G3	B1-U0-G3	B2-U0-G3	B2-U0-G3	B2-U0-G3
	Lumens per Watt	146	139	128	124	147	139	131	126
SL4	Lumens	4,729	5,799	7,178	7,873	9,239	11,333	14,025	15,387
	BUG Rating	B1-U0-G2	B1-U0-G2	B1-U0-G3	B1-U0-G3	B1-U0-G3	B1-U0-G3	B2-U0-G4	B2-U0-G4
	Lumens per Watt	139	132	122	118	140	132	124	119
5NQ	Lumens	5,134	6,296	7,793	8,547	10,033	12,303	15,226	16,704
	BUG Rating	B2-U0-G1	B2-U0-G1	B3-U0-G1	B3-U0-G1	B3-U0-G1	B3-U0-G1	B3-U0-G2	B3-U0-G2
	Lumens per Watt	151	143	132	128	152	143	135	129
5MQ	Lumens	5,228	6,412	7,935	8,705	10,216	12,529	15,508	17,011
	BUG Rating	B3-U0-G1	B3-U0-G1	B3-U0-G2	B3-U0-G2	B3-U0-G2	B4-U0-G2	B4-U0-G2	B4-U0-G2
	Lumens per Watt	154	146	134	130	155	146	137	132
5WQ	Lumens	5,242	6,428	7,956	8,728	10,244	12,563	15,548	17,056
	BUG Rating	B3-U0-G1	B3-U0-G2	B3-U0-G2	B3-U0-G2	B4-U0-G2	B4-U0-G2	B4-U0-G2	B4-U0-G2
	Lumens per Watt	154	146	135	130	155	146	138	132
SLL/SLR	Lumens	4,373	5,365	6,640	7,283	8,547	10,481	12,973	14,231
	BUG Rating	B1-U0-G2	B1-U0-G2	B1-U0-G2	B1-U0-G3	B1-U0-G3	B2-U0-G3	B2-U0-G3	B2-U0-G3
	Lumens per Watt	129	122	113	109	130	122	115	110
RW	Lumens	5,087	6,238	7,721	8,472	9,941	12,190	15,088	16,553
	BUG Rating	B2-U0-G1	B3-U0-G1	B3-U0-G1	B3-U0-G1	B3-U0-G1	B3-U0-G2	B4-U0-G2	B4-U0-G2
	Lumens per Watt	150	142	131	126	151	142	134	128

* Nominal lumen data for 70 CRI. BUG rating for 4000K/5000K. Refer to IES files for 3000K BUG ratings.

3000K CCT, 80 CRI

Number of Light Squares		1				2			
Drive Current		615mA	800mA	1050mA	1.2A	615mA	800mA	1050mA	1.2A
Nominal Power (Watts)		34	44	59	67	66	86	113	129
Input Current @ 120V (A)		0.30	0.39	0.51	0.58	0.58	0.77	1.02	1.16
Input Current @ 208V (A)		0.17	0.22	0.29	0.33	0.34	0.44	0.56	0.63
Input Current @ 240V (A)		0.15	0.19	0.26	0.29	0.30	0.38	0.48	0.55
Input Current @ 277V (A)		0.14	0.17	0.23	0.25	0.28	0.36	0.42	0.48
Input Current @ 347V (A)		0.11	0.15	0.17	0.20	0.19	0.24	0.32	0.39
Input Current @ 480V (A)		0.08	0.11	0.14	0.15	0.15	0.18	0.24	0.30
Optics									
T2	Lumens	3,880	4,759	5,890	6,461	7,583	9,300	11,510	12,628
	BUG Rating	B1-U0-G1	B1-U0-G1	B1-U0-G2	B1-U0-G2	B1-U0-G2	B1-U0-G2	B2-U0-G2	B2-U0-G3
	Lumens per Watt	114	108	100	96	115	108	102	98
T3	Lumens	3,956	4,851	6,004	6,586	7,731	9,479	11,732	12,870
	BUG Rating	B1-U0-G1	B1-U0-G1	B1-U0-G2	B1-U0-G2	B1-U0-G2	B2-U0-G2	B2-U0-G2	B2-U0-G2
	Lumens per Watt	116	110	102	98	117	110	104	100
T4FT	Lumens	3,980	4,879	6,038	6,625	7,774	9,534	11,800	12,945
	BUG Rating	B1-U0-G2	B1-U0-G2	B1-U0-G2	B1-U0-G2	B1-U0-G3	B2-U0-G3	B2-U0-G3	B2-U0-G3
	Lumens per Watt	117	111	102	99	118	111	104	100
T4W	Lumens	3,927	4,816	5,961	6,539	7,675	9,411	11,648	12,778
	BUG Rating	B1-U0-G1	B1-U0-G2	B1-U0-G2	B1-U0-G2	B2-U0-G2	B2-U0-G2	B2-U0-G2	B2-U0-G3
	Lumens per Watt	116	109	101	98	116	109	103	99
SL2	Lumens	3,873	4,751	5,880	6,450	7,571	9,285	11,491	12,605
	BUG Rating	B1-U0-G2	B1-U0-G2	B1-U0-G2	B1-U0-G2	B1-U0-G3	B2-U0-G3	B2-U0-G3	B2-U0-G3
	Lumens per Watt	114	108	100	96	115	108	102	98
SL3	Lumens	3,954	4,851	6,004	6,585	7,729	9,478	11,731	12,868
	BUG Rating	B1-U0-G2	B1-U0-G2	B1-U0-G2	B1-U0-G2	B1-U0-G2	B1-U0-G3	B2-U0-G3	B2-U0-G3
	Lumens per Watt	116	110	102	98	117	110	104	100
SL4	Lumens	3,758	4,608	5,704	6,256	7,342	9,006	11,145	12,227
	BUG Rating	B1-U0-G2	B1-U0-G2	B1-U0-G2	B1-U0-G3	B1-U0-G3	B1-U0-G3	B1-U0-G3	B1-U0-G3
	Lumens per Watt	111	105	97	93	111	105	99	95
5NQ	Lumens	4,080	5,003	6,193	6,792	7,973	9,776	12,099	13,274
	BUG Rating	B2-U0-G0	B2-U0-G1	B2-U0-G1	B2-U0-G1	B3-U0-G1	B3-U0-G1	B3-U0-G1	B3-U0-G2
	Lumens per Watt	120	114	105	101	121	114	107	103
5MQ	Lumens	4,154	5,095	6,305	6,917	8,118	9,956	12,323	13,518
	BUG Rating	B2-U0-G1	B3-U0-G1	B3-U0-G1	B3-U0-G1	B3-U0-G2	B3-U0-G2	B4-U0-G2	B4-U0-G2
	Lumens per Watt	122	116	107	103	123	116	109	105
5WQ	Lumens	4,166	5,108	6,322	6,936	8,140	9,983	12,355	13,553
	BUG Rating	B3-U0-G1	B3-U0-G1	B3-U0-G1	B3-U0-G2	B3-U0-G2	B4-U0-G2	B4-U0-G2	B4-U0-G2
	Lumens per Watt	123	116	107	104	123	116	109	105
SLL/SLR	Lumens	3,475	4,263	5,276	5,787	6,792	8,329	10,309	11,309
	BUG Rating	B1-U0-G2	B1-U0-G2	B1-U0-G2	B1-U0-G2	B1-U0-G3	B1-U0-G3	B2-U0-G3	B2-U0-G3
	Lumens per Watt	102	97	89	86	103	97	91	88
RW	Lumens	4,042	4,957	6,135	6,732	7,900	9,687	11,990	13,154
	BUG Rating	B2-U0-G1	B2-U0-G1	B3-U0-G1	B3-U0-G1	B3-U0-G1	B3-U0-G1	B3-U0-G2	B3-U0-G2
	Lumens per Watt	119	113	104	100	120	113	106	102

* Nominal lumen data for 70 CRI. BUG rating for 4000K/5000K. Refer to IES files for 3000K BUG ratings.

Control Options

0-10V This fixture is offered standard with 0-10V dimming driver(s). The DIM option provides 0-10V dimming wire leads for use with a lighting control panel or other control method.

Photocontrol (BPC, PR, and PR7) Optional button-type photocontrol (BPC) and photocontrol receptacles (PR and PR7) provide a flexible solution to enable “dusk-to-dawn” lighting by sensing light levels. Advanced control systems compatible with NEMA 7-pin standards can be utilized with the PR7 receptacle.

After Hours Dim (AHD) This feature allows photocontrol-enabled luminaires to achieve additional energy savings by dimming during scheduled portions of the night. The dimming profile will automatically take effect after a “dusk-to-dawn” period has been calculated from the photocontrol input. Specify the desired dimming profile for a simple, factory-shipped dimming solution requiring no external control wiring. Reference the After Hours Dim supplemental guide for additional information.

Dimming Occupancy Sensor (SPB, MS/DIM-LXX and MS-LXX) These sensors are factory installed in the luminaire housing. When the SPB or MS/DIM sensor options are selected, the occupancy sensor is connected to a dimming driver and the entire luminaire dims when there is no activity detected. When activity is detected, the luminaire returns to full light output. The MS/DIM sensor is factory preset to dim down to approximately 50 percent power with a time delay of five minutes. The MS-LXX sensor is factory preset to turn the luminaire off after five minutes of no activity. SPB motion sensors require the Sensor Configuration mobile application by Wattstopper to change factory default dimming level, time delay, sensitivity and other parameters. Available for iOS and Android devices. The SPB sensor is factory preset to dim down to approximately 10% power with a time delay of five minutes. The MS/DIM occupancy sensors require the FSIR-100 programming tool to adjust factory defaults.

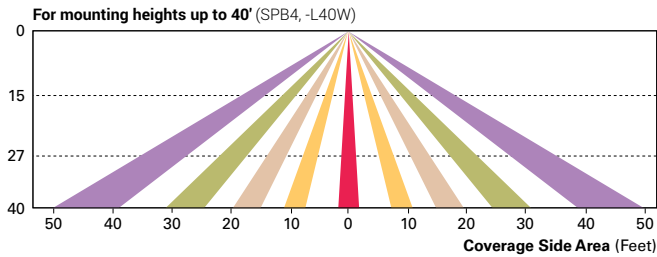
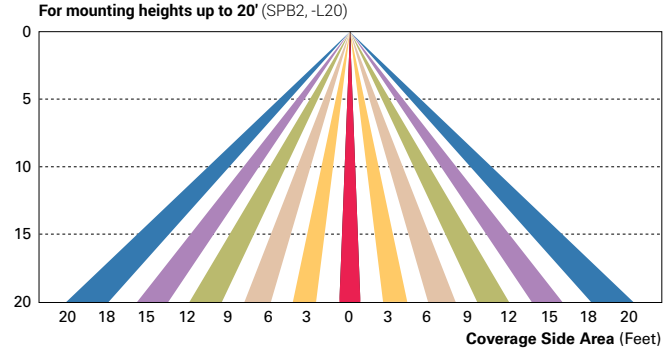
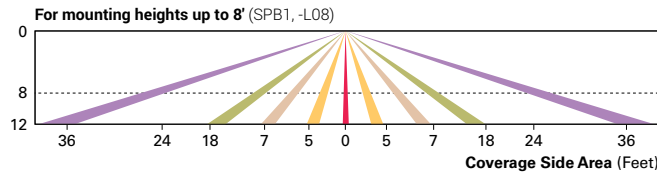

Enlighted Wireless Control and Monitoring System (LWR-LW and LWR-LN) The Enlighted control system is a connected lighting solution, combining LED luminaires with an integrated wireless sensor system. The sensor controls the lighting system in compliance with the latest energy codes while collecting valuable data about building performance and use. Software applications utilizing energy dashboards maximize data inputs to help optimize the use of other resources beyond lighting.

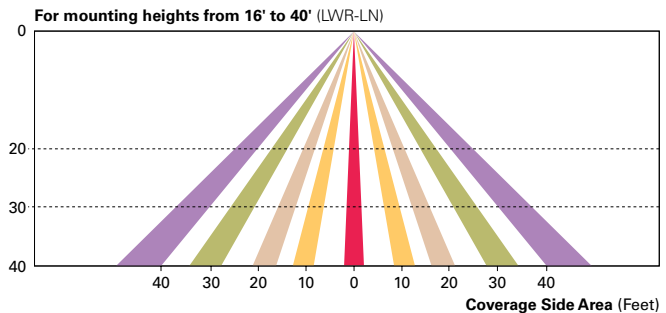
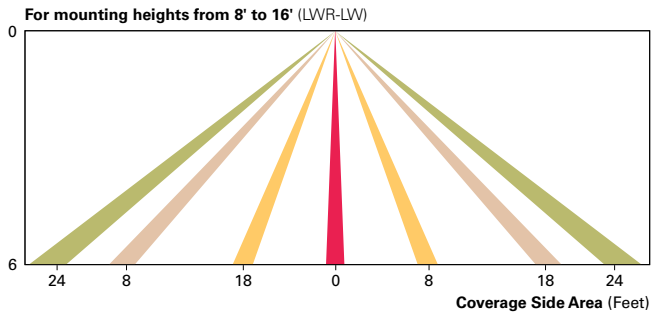

WaveLinx Wireless Outdoor Lighting Control Module (WOLC-7P-10A) The 7-pin wireless outdoor lighting control module enables WaveLinx to control outdoor area, site and flood lighting. WaveLinx controls outdoor lighting using schedules to provide ON, OFF and dimming controls based on astronomic or time schedules based on a 7 day week.

Project		Catalog #		Type	
Prepared by		Notes		Date	



Lumark

PRV / PRV-XL Prevail LED

Area / Site Luminaire

Product Features



Product Certifications



Interactive Menu

- Ordering Information [page 2](#)
- Mounting Details [page 3](#)
- Optical Configurations [page 3](#)
- Product Specifications [page 3](#)
- Energy and Performance Data [page 4](#)
- Control Options [page 5](#)

Quick Facts

- Lumen packages range from 7,100 - 48,600 lumens (50W - 350W)
- Replaces 70W up to 1,000W HID equivalents
- Efficacies up to 148 lumens per watt
- Energy and maintenance savings up to 85% versus HID solutions
- Standard universal quick mount arm with universal drill pattern

Connected Systems

- WaveLinx
- Enlighted

Dimensional Details

Prevail

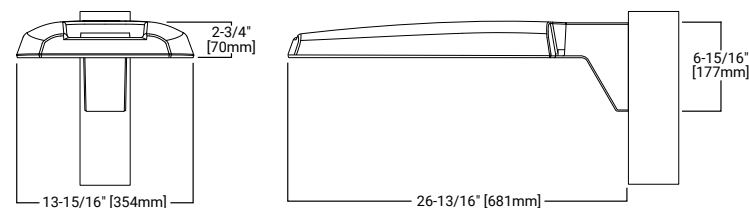

Prevail XL

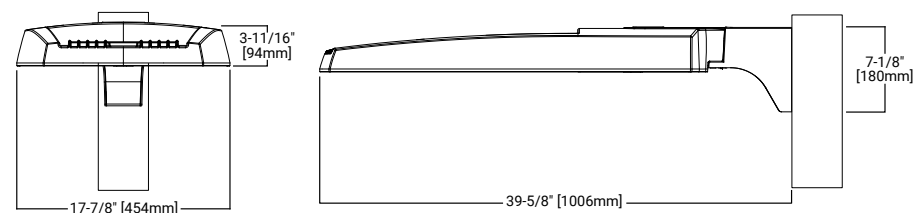

Ordering Information

SAMPLE NUMBER: PRV-XL-C75-D-UNV-T4-SA-BZ

Product Family ^{1,2}	Light Engine ³	Driver	Voltage	Distribution	Mounting (Included)	Color
PRV=Prevail	C15=(1 LED) 7,100 Nominal Lumens C25=(2 LEDs) 13,100 Nominal Lumens C40=(2 LEDs) 17,100 Nominal Lumens C60=(2 LEDs) 20,000 Nominal Lumens	D=Dimming (0-10V)	UNV=Universal (120-277V) 347=347V 480=480V ⁴	T2=Type II T3=Type III T4=Type IV T5=Type V	SA=Standard Versatile Arm MA=Mast Arm WM=Wall Mount Arm	AP=Grey BZ=Bronze BK=Black DP=Dark Platinum GM=Graphite Metallic WH=White
PRV-XL=Prevail XL	C75=(4 LED) 26,100 Nominal Lumens C100=(4 LED) 31,000 Nominal Lumens C125=(4 LED) 36,000 Nominal Lumens C150=(6 LED) 41,100 Nominal Lumens C175=(6 LED) 48,600 Nominal Lumens					

Options (Add as Suffix)	Accessories (Order Separately) ¹⁸
<p>7030=70 CRI / 3000K CCT ⁵ 7035=70CRI / 3500K CCT ⁵ 7050=70 CRI / 5000K CCT ⁵ HSS=House Side Shield ⁶ L90=Optics Rotated 90° Left R90=Optics Rotated 90° Right 10K=10kV UL 1449 Fused Surge Protective Device 20MSP=20kV MOV Surge Protective Device 20K=Series 20kV UL 1449 Surge Protective Device HA=50°C High Ambient Temperature ⁷ PER=NEMA 3-PIN Twistlock Photocontrol Receptacle PER7=NEMA 7-PIN Twistlock Photocontrol Receptacle SPB2=Dimming Occupancy Sensor with Bluetooth Interface, 8'-20' Mounting ²⁴ SPB4=Dimming Occupancy Sensor with Bluetooth Interface, 21'-40' Mounting ²⁴ MSP/DIM-L12=Integrated Sensor for Dimming Operation, 8' - 12' Mounting Height ^{8,9} MSP/DIM-L30=Integrated Sensor for Dimming Operation, 12' - 30' Mounting Height ^{8,9} MSP-L12=Integrated Sensor ON/OFF Operation, 8' - 12' Mounting Height ^{8,9} MSP-L30=Integrated Sensor ON/OFF Dimming Operation, 12' - 30' Mounting Height ^{8,9} MS/DIM-L20=Motion Sensor for Dimming Operation, 9' - 20' Mounting Height ^{9,10} MS/DIM-L40W=Motion Sensor for Dimming Operation, 21' - 40' Mounting Height ^{9,10} MS-L20=Motion Sensor for ON/OFF Operation, 9' - 20' Mounting Height ^{9,10} MS-L40W=Motion Sensor for ON/OFF Operation, 21' - 40' Mounting Height ^{9,10} ZD=DALI-enabled 4-PIN Twistlock Receptacle ^{9,11,12} ZW=Wavelinx-enabled 4-PIN Twistlock Receptacle ^{9,11,12} SWPD4XX=Wavelinx Wireless Sensor, 7' - 15' Mounting Height ^{9,11,12,13,14} SWPD5XX=Wavelinx Wireless Sensor, 15' - 40' Mounting Height ^{9,11,12,13,14} LWR-LW=Enlighted Wireless Sensor, Wide Lens for 8' - 16' Mounting Height ^{9,15} LWR-LN=Enlighted Wireless Sensor, Narrow Lens for 16' - 40' Mounting Height ^{9,15} (See Table Below)=LumenSafe Integrated Network Security Camera ^{16,17} CC=Coastal Construction ²³</p>	<p>PRVWM-XX=Wall Mount Kit ⁸ PRVMA-XX=Mast Arm Mounting Kit ⁸ PRVSA-XX=Standard Arm Mounting Kit ⁸ PRVXLSA-XX=Standard Arm Mounting Kit (for Prevail XL) ¹⁶ PRVXLWM-XX=Wall Mount Kit (for Prevail XL) ¹⁶ PRVXLMA-XX=Mast Arm Mounting Kit (for Prevail XL) ¹⁶ MA1010-XX=Single Tenon Adapter for 3-1/2" O.D. Tenon MA1011-XX=2@180° Tenon Adapter for 3-1/2" O.D. Tenon MA1017-XX=Single Tenon Adapter for 2-3/8" O.D. Tenon MA1018-XX=2@180° Tenon Adapter for 2-3/8" O.D. Tenon HS/VERD=House Side Shield ^{6,19} VGS-F/B=Vertical Glare Shield, Front/Back ¹⁹ VGS-SIDE=Vertical Glare Shield, Side ¹⁹ OA/RA1013=Photocontrol Shorting Cap OA/RA1014=NEMA Photocontrol - 120V OA/RA1016=NEMA Photocontrol - Multi-Tap 105-285V OA/RA1201=NEMA Photocontrol - 347V OA/RA1027=NEMA Photocontrol - 480V ISHH-01=Integrated Sensor Programming Remote ²⁰ FSIR-100=Wireless Configuration Tool for Occupancy Sensor ²¹ SWPD4-XX=WaveLinX Wireless Sensor, 7' - 15' Mounting Height ^{12,13,14} SWPD5-XX=WaveLinX Wireless Sensor, 15' - 40' Mounting Height ^{12,13,14} WOLC-7P-10A=WaveLinX Outdoor Control Module (7-PIN) ²²</p>

NOTES:

- DesignLights Consortium® Qualified. Refer to www.designlights.org Qualified Products List under Family Models for details.
- Customer is responsible for engineering analysis to confirm pole and fixture compatibility for applications. Refer to installation instructions and pole white paper WP513001EN for additional support information.
- Standard 4000K CCT and 70CRI.
- Only for use with 480V Wye systems. Per NEC, not for use with ungrounded systems, impedance grounded systems or corner grounded systems (commonly known as Three Phase Three Wire Delta, Three Phase High Leg Delta and Three Phase Corner Grounded Delta systems).
- Use dedicated IES files on product website for non-standard CCTs.
- Option will come factory-installed. House Side Shield not suitable with T5 distribution or C60 lumen package.
- Not available with C60 lumen package.
- Only available in PRV configurations C15, C25, C40 or C60.
- Controls system is not available with photocontrol receptacle (PER or PER7) or other controls systems (MS, MSP, ZW, ZD or LWR).
- Utilizes the Wattstopper sensor FSP-211.
- Sensor passive infrared (PIR) may be overly sensitive when operating below -20°C (-4°F).
- For the device to be field-configurable, requires WAC Gateway components WAC-PoE and WPOE-120 in appropriate quantities. Only compatible with WaveLinX system and software and requires system components to be installed for operation. See website for more Wavelinx application information.
- Replace XX with sensor color (WH, BZ, or BK).
- Requires 4-PIN twistlock receptacle (ZD or ZW) option.
- Enlighted wireless sensors are factory installed and require network components LWP-EM-1, LWP-GW-1, and LWP-PoE8 in appropriate quantities. See website for application information.
- Only available in PRV-XL configurations C75, C100, C125, C150, or C175.
- Not available with 347V, 480V, or HA options. Consult LumenSafe system product pages for additional details and compatibility information.
- Replace XX with paint color.
- Must order one per optic/LED when ordering as a field-installable accessory (1, 2, 4, or 6).
- This tool enables adjustment to Integrated Sensor (MSP) parameters including high and low modes, sensitivity, time delay, cutoff and more. Consult your lighting representative at Cooper Lighting Solutions for more information.
- This tool enables adjustment to Motion Sensor (MS) parameters including high and low modes, sensitivity, time delay, cutoff and more. Consult your lighting representative at Cooper Lighting Solutions for more information.
- Requires 7-PIN NEMA twistlock photocontrol receptacle (PER7) option. The WOLC-7 cannot be used in conjunction with other controls systems (MS, MSP, ZW, ZD or LWR). Operates on 120-347V input voltages.
- Coastal construction finish salt spray tested to over 5,000-hours per ASTM B117, with a scribe rating of 9 per ASTM D1654.
- Smart device with mobile application required to change system defaults. See controls section for details.

LumenSafe Integrated Network Security Camera Technology Options (Add as Suffix)

Product Family	Camera Type	Data Backhaul
L=LumenSafe Technology 	D=Dome Camera	C=Cellular, Customer Installed SIM Card A=Cellular, Factory Installed AT&T SIM Card V=Cellular, Factory Installed Verizon SIM Card S=Cellular, Factory Installed Sprint SIM Card E=Ethernet Networking

Stock Ordering Information

Product Family ¹	Light Engine	Voltage	Distribution	Options (Add as Suffix)
PRVS=Prevail	C15=(1 LED) 7,100 Nominal Lumens C25=(2 LEDs) 13,100 Nominal Lumens C40=(2 LEDs) 17,100 Nominal Lumens C60=(2 LEDs) 20,000 Nominal Lumens	UNV=Universal (120-277V) 347=347V ²	T3=Type III T4=Type IV	MSP/DIM-L30=Integrated Sensor for Dimming Operation, Maximum 30' Mounting Height ²
PRVS-XL=Prevail XL	C75=(4 LED) 26,100 Nominal Lumens C100=(4 LED) 31,000 Nominal Lumens C125=(4 LED) 36,000 Nominal Lumens C150=(6 LED) 41,100 Nominal Lumens C175=(6 LED) 48,600 Nominal Lumens			

NOTES:

- All stock configurations are standard 4000K/70CRI, bronze finish, and include the standard versatile mounting arm.
- Only available in PRVS configurations C15, C25, C40 or C60.

Mounting Details

Pole Mount Arm (PRV)

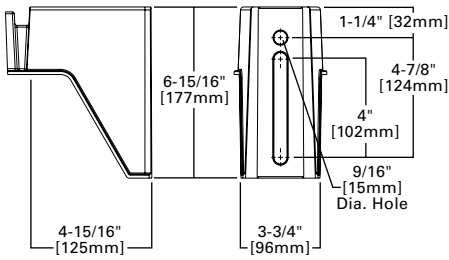

Pole Mount Arm (PRV-XL)

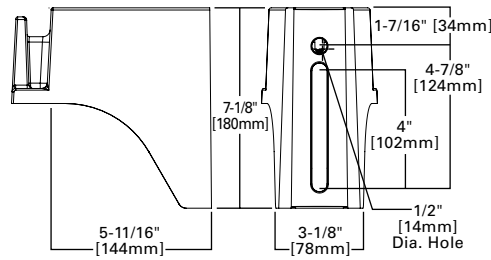

Versatile Mount System

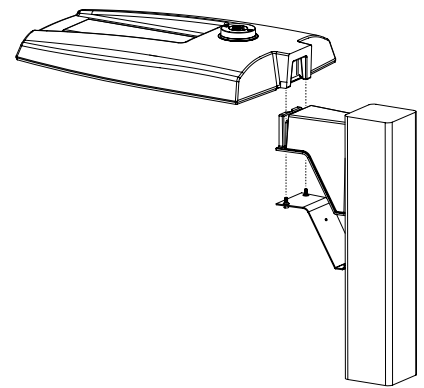

Wall Mount (PRV)

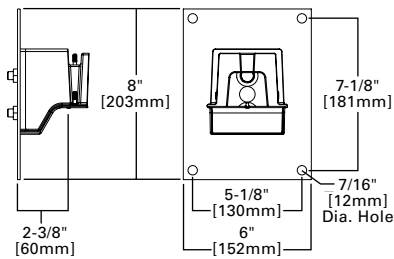

Wall Mount (PRV-XL)

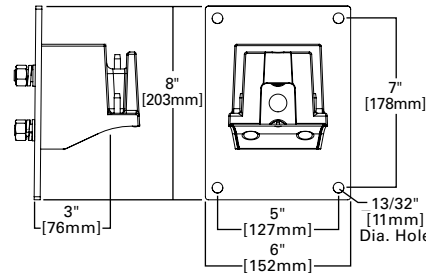

Mast Arm Mount (PRV)

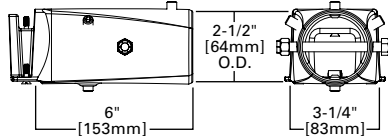

Mast Arm Mount (PRV-XL)

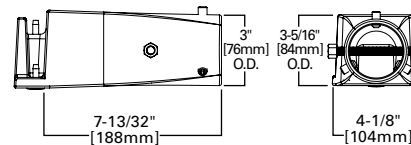

Mounting Configurations and EPAs

NOTE: For 2 PRV's mounted at 90°, requires minimum 3" square or 4" round pole for fixture clearance. For 2 PRV-XL's mounted at 90°, requires minimum 4" square or round pole for fixture clearance. Customer is responsible for engineering analysis to confirm pole and fixture compatibility for applications.

Wall Mount	Arm Mount Single EPA 0.92 (PRV) EPA 1.12 (PRV-XL)	Arm Mount 2 @ 180° EPA 1.35 (PRV) EPA 2.25 (PRV-XL)	Arm Mount 2 @ 90° EPA 1.42 (PRV) EPA 2.13 (PRV-XL)	Arm Mount 3 @ 90° EPA 1.63 (PRV) EPA 2.52 (PRV-XL)	Arm Mount 4 @ 90° EPA 1.63 (PRV) EPA 2.52 (PRV-XL)
-------------------	--	--	---	---	---

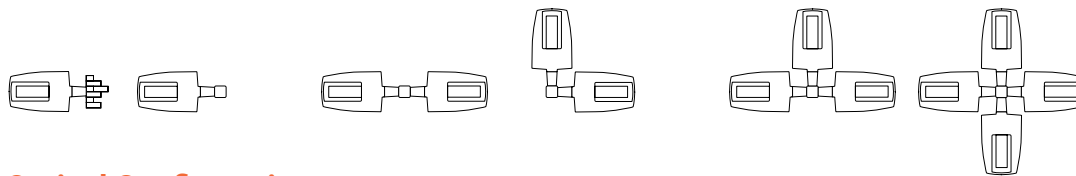

Optical Configurations

PRV-C15 (7,100 Nominal Lumens)	PRV-C25/C40/C60 (13,100/17,100/20,000 Nominal Lumens)	PRV-XL-C75/C100/C125 (26,100/31,000/36,300 Nominal Lumens)	PRV-XL-C150/C175 (41,100/48,600 Nominal Lumens)
--	---	--	---

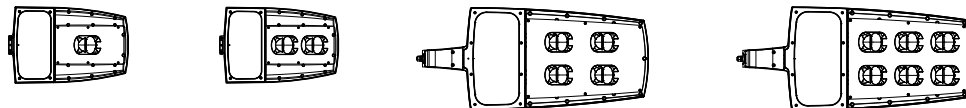

Product Specifications

Construction

- Single-piece die-cast aluminum housing
- Tethered die-cast aluminum door

Optics

- Dark Sky Approved (3000K CCT and warmer only)
- Precision molded polycarbonate optics

Electrical

- -40°C minimum operating temperature
- 40°C maximum operating temperature
- >.9 power factor
- <20% total harmonic distortion

- Class 1 electronic drivers have expected life of 100,000 hours with <1% failure rate
- 0-10V dimming driver is standard with leads external to the fixture

Mounting

- Versatile, patented, standard mount arm accommodates multiple drill patterns ranging from 1-1/2" to 4-7/8"
- A knock-out on the standard mounting arm enables round pole mounting
- Prevail: 3G vibration rated
- Prevail XL Mast Arm: 3G vibration rated
- Prevail XL Standard Arm: 1.5G vibration rated

Finish

- Five-stage super TGIC polyester powder coat paint, 2.5 mil nominal thickness

Shipping Data

- Prevail: 20 lbs. (9.09 kgs.)
- Prevail XL: 45 lbs. (20.41 kgs.)

Energy and Performance Data

Power and Lumens (PRV)

 [View PRV IES files](#)

Light Engine	C15	C25	C40	C60	
Power (Watts)	52	96	131	153	
Input Current @ 120V (A)	0.43	0.80	1.09	1.32	
Input Current @ 277V (A)	0.19	0.35	0.48	0.57	
Input Current @ 347V (A)	0.17	0.30	0.41	0.48	
Input Current @ 480V (A)	0.12	0.22	0.30	0.35	
Distribution					
Type II	4000K Lumens	7,123	13,205	17,172	20,083
	BUG Rating	B2-U0-G2	B2-U0-G2	B3-U0-G3	B3-U0-G3
	3000K Lumens	6,994	12,965	16,860	19,718
Type III	4000K Lumens	7,111	13,183	17,144	20,050
	BUG Rating	B1-U0-G2	B2-U0-G3	B3-U0-G4	B3-U0-G4
	3000K Lumens	6,982	12,944	16,832	19,686
Type IV	4000K Lumens	7,088	13,140	17,087	19,984
	BUG Rating	B1-U0-G3	B2-U0-G4	B2-U0-G4	B3-U0-G5
	3000K Lumens	6,959	12,901	16,777	19,621
Type V	4000K Lumens	7,576	14,045	18,264	21,360
	BUG Rating	B3-U0-G3	B4-U0-G3	B4-U0-G4	B5-U0-G4
	3000K Lumens	7,438	13,790	17,932	20,972

Lumen Maintenance

Configuration	TM-21 Lumen Maintenance (50,000 Hours)	Theoretical L70 (Hours)
Up to PRV-C60 at 25°C	91.30%	194,000
Up to PRV-C60 at 40°C	87.59%	134,000
Up to PRV-XL-C175 at 25°C	91.40%	204,000
Up to PRV-XL-C175 at 40°C	89.41%	158,000

Lumen Multiplier

Ambient Temperature	Lumen Multiplier
10°C	1.02
15°C	1.01
25°C	1.00
40°C	0.99

Power and Lumens (PRV-XL)

 [View PRV-XL IES files](#)

Light Engine	C75	C100	C125	C150	C175	
Power (Watts)	176	217	264	285	346	
Input Current @ 120V (A)	1.50	1.84	2.21	2.38	2.92	
Input Current @ 277V (A)	0.66	0.82	0.97	1.04	1.25	
Input Current @ 347V (A)	0.54	0.66	0.79	0.84	1.02	
Input Current @ 480V (A)	0.40	0.48	0.57	0.62	0.74	
Distribution						
Type II	4000K Lumens	26,263	31,231	36,503	41,349	48,876
	BUG Rating	B3-U0-G3	B3-U0-G4	B4-U0-G4	B4-U0-G4	B4-U0-G5
	3000K Lumens	25,786	30,664	35,840	40,598	47,989
Type III	4000K Lumens	26,120	31,061	36,304	41,124	48,610
	BUG Rating	B3-U0-G5	B3-U0-G5	B3-U0-G5	B4-U0-G5	B4-U0-G5
	3000K Lumens	25,646	30,497	35,645	40,377	47,727
Type IV	4000K Lumens	26,098	31,035	36,274	41,089	48,569
	BUG Rating	B3-U0-G5	B3-U0-G5	B3-U0-G5	B3-U0-G5	B4-U0-G5
	3000K Lumens	25,624	30,471	35,615	40,343	47,687
Type V	4000K Lumens	28,129	33,450	39,097	44,287	52,349
	BUG Rating	B5-U0-G5	B5-U0-G5	B5-U0-G5	B5-U0-G5	B5-U0-G5
	3000K Lumens	27,618	32,843	38,387	43,483	51,398

Control Options

0-10V (D) The dimming option provides 0-10V dimming wire leads for use with a lighting control panel or other control method.

Photocontrol (PER and PER7) Photocontrol receptacles provide a flexible solution to enable "dusk-to-dawn" lighting by sensing light levels. Advanced control systems compatible with NEMA 7-pin standards can be utilized with the PER7 receptacle.

Dimming Occupancy Sensor (SPB, MSP and MS) These sensors are factory installed in the luminaire housing. When a sensor for dimming operation (/DIM) option is selected, the luminaire will dim down to approximately 50 percent power after five minutes of no activity detected. When activity is detected, the luminaire returns to full light output. When a sensor for ON/OFF operation is selected, the luminaire will turn off after five minutes of no activity. The SPB is factory preset to dim down to 10% power with a time delay of five minutes. To reconfigure the SPB, the Sensor Configuration application by Wattstopper for iOS and Android devices is required to change factory default dimming level, time delay, sensitivity and other parameters.

These occupancy sensors include an integral photocell that can be activated or inactivated with the programming remote / configuration tool for "dusk-to-dawn" control or "daylight harvesting". **Note:** For MSP sensors, the factory preset is ON (Enabled), and for MS sensors, the factory preset is OFF (Disabled). The programming remote / tool is a wireless tool that can be utilized to change the dimming level, time delay, sensitivity and other parameters. A variety of sensor lenses are available to optimize the coverage pattern for mounting heights from 8'-40'.

For mounting heights from 8' to 12' (-L12)

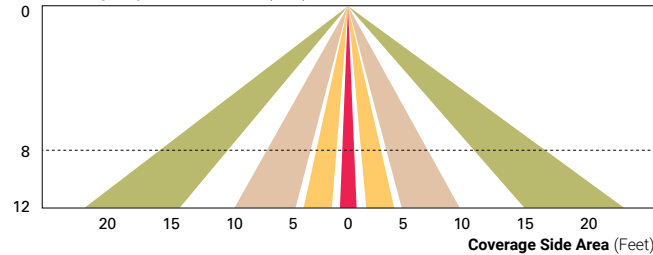

For mounting heights from 12' to 30' (-L30)

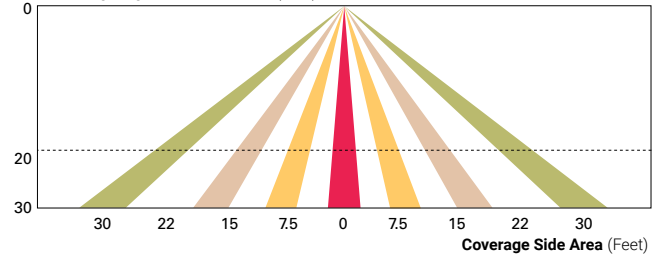

For mounting heights from 9' to 20' (-L20)

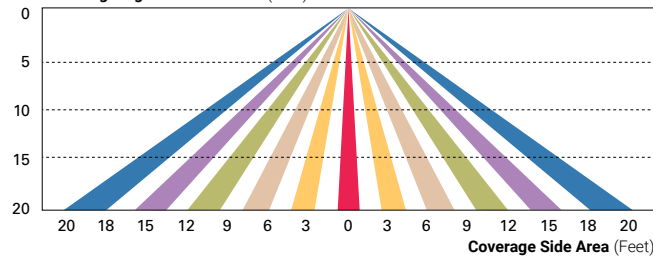

For mounting heights from 21' to 40' (-L40W)

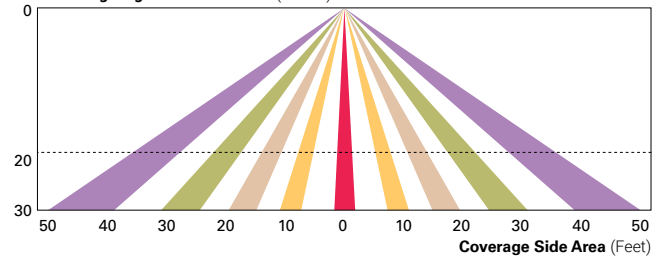

WaveLinx Wireless Control and Monitoring System Available in 7-PIN or 4-PIN configurations, the WaveLinx Outdoor control platform operates on a wireless mesh network based on IEEE 802.15.4 standards enabling wireless control of outdoor lighting. Use the WaveLinx Mobile application for set-up and configuration. At least one Wireless Area Controller (WAC) is required for full functionality and remote communication (including adjustment of any factory pre-sets).

WaveLinx Outdoor Control Module (WOLC-7P-10A) A photocontrol that enables astronomical or time-based schedules to provide ON, OFF and dimming control of fixtures utilizing a 7-PIN receptacle. The out-of-box functionality is ON at dusk and OFF at dawn.

WaveLinx Wireless Sensor (SWPD4 and SWPD5) These outdoor sensors offer passive infrared (PIR) occupancy and a photocell for closed loop daylight sensing. These sensors can be factory installed or field-installed via simple, tool-less integration into luminaires equipped with the Zhaga Book 18 compliant 4-PIN receptacle (ZD or ZW). These sensors are factory preset to dim down to approximately 50 percent power after 15 minutes of no activity detected. These occupancy sensors include an integral photocell for "dusk-to-dawn" control or daylight harvesting that is factory-enabled. A variety of sensor lenses are available to optimize the coverage pattern for mounting heights from 7'-40'.

For mounting heights from 16' to 40' (SWPD)

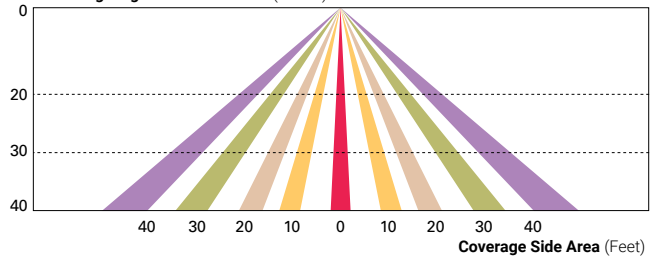

Enlighted Wireless Control and Monitoring System (LWR-LW and LWR-LN) The Enlighted System is a connected lighting solution that combines LED luminaires with an integrated wireless sensor system. The sensor controls the lighting system in compliance with the latest energy codes and collects valuable data about building performance and use. Software applications turn the granular data into information through energy dashboards and specialized apps that make it simple and help optimize the use of other resources beyond lighting.

For mounting heights from 8' to 16' (LWR-LW)

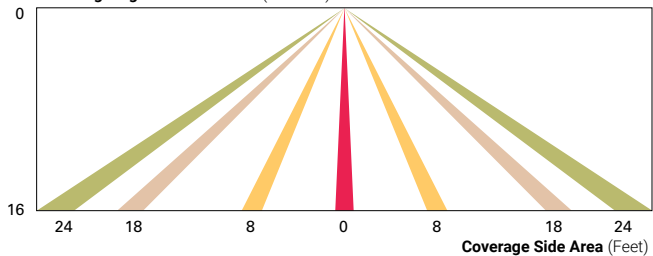

For mounting heights from 16' to 40' (LWR-LN)

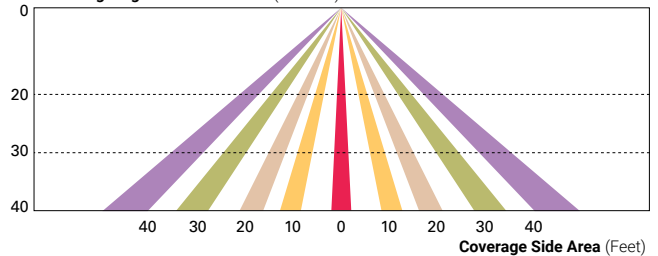

LumenSafe (LD) The LumenSafe integrated network camera is a streamlined, outdoor-ready camera that provides high definition video surveillance. This IP camera solution is optimally designed to integrate into virtually any video management system or security software platform of choice. No additional wiring is needed beyond providing line power to the luminaire. LumenSafe features factory-installed power and networking gear in a variety of networking options allowing security integrators to design the optimal solution for active surveillance.



Project Name _____ Pole Type _____
Catalog # _____

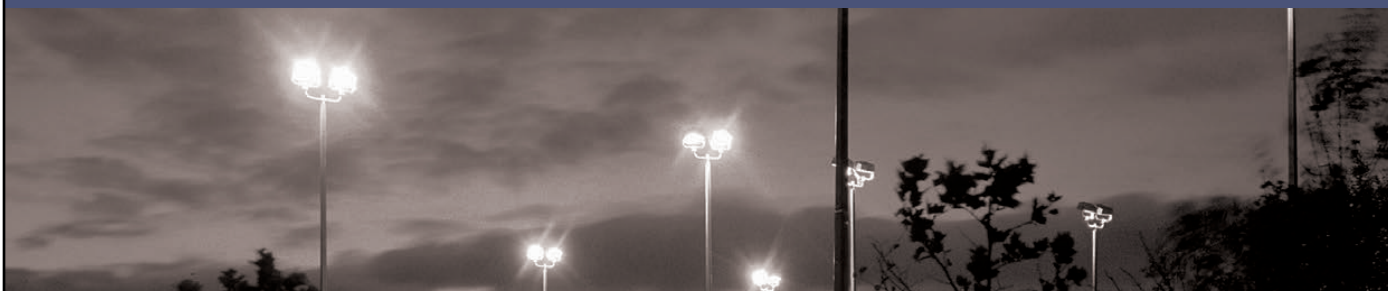

Round Tapered Fiberglass Light Poles, Direct Burial

Product Overview

- **Pole Shaft** - Manufactured on computer-controlled equipment to customer specifications using filament wound technology. Strict control of glass, fiber and resin ensures a consistent product. Less electrically conductive than steel, aluminum or wood.
- **Pole Top** - Poles can be provided with tenon top construction or capped/drilled to customer specifications. Tenons on all poles are made of high-strength corrosion resistant aluminum.
- **Hand Hole** - 2.5"x 5" hand hole is provided at the base end of the pole assembly. Each hand hole includes a cover and the cover attachment hardware.
- **Grommet** - 1.5" in diameter hole for conduit located 24" below ground line unless otherwise specified.
- **Anti-Rotation Device** - Wound permanently into the pole below grade. Located 6" from the bottom of the pole.
- **Finish** - Rust-proof and corrosion-resistant for low lifetime maintenance. We finish our smooth and natural poles with a special finishing resin applied at 12 - 15 mils thick which provides a superior finish to the normal 1.5 mil thick paint. Resin is pigmented and fortified with ultraviolet inhibitors to produce a long-lasting, reliable product.
- **Engineering & Compliance** - Poles are constructed to comply with specifications of ANSI, AASHTO and ASTM standards. High-wind-speed light poles with ratings up to 180 mph available by contacting the factory.

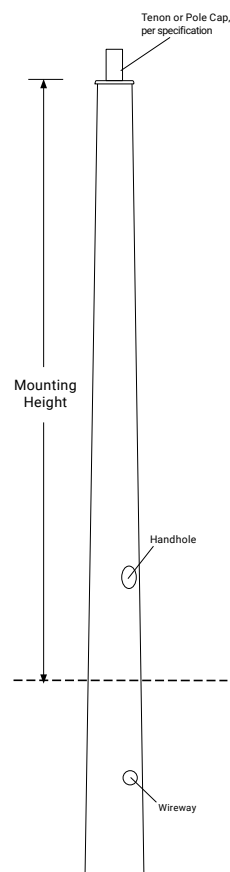

206 W. McWilliams St.
Fond du Lac, WI 54935

800-558-4810
quotes@nafcointernational.com
NAFCOmfg.com



Rev. V05102018

This specification brochure is intended to serve as a general guide. Our products are continually being engineered and improved, and specifications are subject to change without notice.



EPA Load Information

BASE MODEL	120mph (FBC)		130mph (FBC)		140mph (FBC)		150mph (FBC)		170mph (FBC)		180mph (FBC)	
	90mph (STD)		100mph (STD)		110mph (STD)		120mph (STD)		130mph (STD)		140mph (STD)	
	MAX EPA (SQFT)	MAX WEIGHT (LBS)	MAX EPA (SQFT)	MAX WEIGHT (LBS)	MAX EPA (SQFT)	MAX WEIGHT (LBS)	MAX EPA (SQFT)	MAX WEIGHT (LBS)	MAX EPA (SQFT)	MAX WEIGHT (LBS)	MAX EPA (SQFT)	MAX WEIGHT (LBS)
AL-RTFD-10-0000-SD-NA	6.5	150	4.5	150	4.1	150	3.2	150	2.5	150	1.9	150
AL-RTFD-10-0000-ID-NA	9.8	150	7.1	150	6.5	150	5.2	150	4.2	150	3.4	150
AL-RTFD-10-0000-HD-NA	13	150	9.6	150	8.9	150	7.2	150	5.9	150	4.9	150
AL-RTFD-10-0000-ED-NA	15.9	150	12.1	150	11.2	150	9.2	150	7.5	150	6.3	150
AL-RTFD-12-0000-SD-NA	6.5	150	4.5	150	4.1	150	3.2	150	2.5	150	1.9	150
AL-RTFD-12-0000-ID-NA	9.8	150	7.1	150	6.5	150	5.2	150	4.2	150	3.4	150
AL-RTFD-12-0000-HD-NA	13	150	9.6	150	8.9	150	7.2	150	5.9	150	4.9	150
AL-RTFD-12-0000-ED-NA	15.9	150	12.1	150	11.2	150	9.2	150	7.5	150	6.3	150
AL-RTFD-14-0000-SD-NA	6.5	150	4.5	150	4.1	150	3.2	150	2.5	150	1.9	150
AL-RTFD-14-0000-ID-NA	9.8	150	7.1	150	6.5	150	5.2	150	4.2	150	3.4	150
AL-RTFD-14-0000-HD-NA	13	150	9.6	150	8.9	150	7.2	150	5.9	150	4.9	150
AL-RTFD-14-0000-ED-NA	15.9	150	12.1	150	11.2	150	9.2	150	7.5	150	6.3	150
AL-RTFD-16-0000-SD-NA	6.5	150	4.5	150	4.1	150	3.1	150	2.4	150	1.8	150
AL-RTFD-16-0000-ID-NA	9.7	150	7.1	150	6.5	150	5.2	150	4.1	150	3.3	150
AL-RTFD-16-0000-HD-NA	12.7	150	9.5	150	8.8	150	7.1	150	5.8	150	4.8	150
AL-RTFD-16-0000-ED-NA	16.3	150	12.5	150	11.6	150	9.4	150	7.7	150	6.4	150
AL-RTFD-18-0000-SD-NA	6	150	5.6	150	5.1	150	3.9	150	3.1	150	2.4	150
AL-RTFD-18-0000-ID-NA	9.8	150	7.6	150	7	150	5.5	150	4.4	150	3.6	150
AL-RTFD-18-0000-HD-NA	12.2	150	9.5	150	8.8	150	7	150	5.7	150	4.7	150
AL-RTFD-18-0000-ED-NA	15.8	150	12.5	150	11.5	150	9.3	150	7.7	150	6.4	150
AL-RTFD-20-0000-SD-NA	6.7	150	6.5	150	5.9	150	4.6	150	3.6	150	2.8	150
AL-RTFD-20-0000-ID-NA	11.8	150	8.9	150	8.2	150	6.5	150	5.2	150	4.3	150
AL-RTFD-20-0000-HD-NA	14.4	150	11.3	150	10.4	150	8.3	150	6.8	150	5.6	150
AL-RTFD-20-0000-ED-NA	17	150	13.4	150	12.5	150	10	150	8.2	150	6.8	150
AL-RTFD-22-0000-SD-NA	6.8	150	6.6	150	6.4	150	4.9	150	3.9	150	3	150
AL-RTFD-22-0000-ID-NA	11.9	150	9.2	150	8.5	150	6.7	150	5.4	150	4.3	150
AL-RTFD-22-0000-HD-NA	14.6	150	11.5	150	10.6	150	8.4	150	6.8	150	5.6	150
AL-RTFD-22-0000-ED-NA	19.2	150	15.3	150	14.1	150	11.4	150	9.4	150	7.8	150
AL-RTFD-23-0000-SD-NA	8	150	6.2	150	5.6	150	4.8	150	3.7	150	2.9	150
AL-RTFD-23-0000-ID-NA	12.1	150	9.4	150	8.6	150	6.8	150	5.4	150	4.3	150
AL-RTFD-23-0000-HD-NA	15.2	150	11.9	150	11	150	8.8	150	7.1	150	5.8	150
AL-RTFD-23-0000-ED-NA	21	150	16.7	150	15.4	150	12.5	150	10.2	150	8.8	150
AL-RTFD-25-0000-SD-NA	9.5	150	7.2	150	6.5	150	5	150	3.9	150	3	150
AL-RTFD-25-0000-ID-NA	13	150	10.1	150	9.2	150	7.3	150	5.8	150	4.7	150
AL-RTFD-25-0000-HD-NA	16.4	150	12.8	150	11.8	150	9.5	150	7.7	150	6.3	150
AL-RTFD-25-0000-ED-NA	24.5	150	19.5	150	18	150	14.8	150	12.1	150	10.1	150
AL-RTFD-27-0000-SD-NA	9	150	7.3	150	6.7	150	5.1	150	3.9	150	3	150
AL-RTFD-27-0000-ID-NA	13.3	150	10.3	150	9.4	150	7.4	150	5.9	150	4.7	150
AL-RTFD-27-0000-HD-NA	16.6	150	13	150	12	150	9.5	150	7.7	150	6.3	150
AL-RTFD-27-0000-ED-NA	25.3	150	20.2	150	18.7	150	15.2	150	12.5	150	10.4	150
AL-RTFD-30-0000-SD-NA	9.9	150	7.4	150	6.9	150	5.2	150	3.9	150	3	150
AL-RTFD-30-0000-ID-NA	13.1	150	11.8	150	10.8	150	8.6	150	6.9	150	5.6	150
AL-RTFD-30-0000-HD-NA	18.9	150	14.9	150	13.7	150	11	150	9	150	7.4	150
AL-RTFD-30-0000-ED-NA	26.6	150	21.2	150	19.7	150	16	150	13.2	150	11	150
AL-RTFD-32-0000-SD-NA	9.5	150	8.3	150	7.6	150	6	150	4.9	150	3.8	150
AL-RTFD-32-0000-ID-NA	13.2	150	11.9	150	10.9	150	8.6	150	6.4	150	5.2	150
AL-RTFD-32-0000-HD-NA	19	150	14.8	150	13.6	150	10.9	150	8.4	150	7.1	150
AL-RTFD-32-0000-ED-NA	26.3	150	21	150	19.5	150	15.8	150	12.5	150	9.6	150
AL-RTFD-35-0000-SD-NA	11.5	150	9.1	150	8	150	6.1	150	3.8	150	2.8	150
AL-RTFD-35-0000-ID-NA	15.7	150	12.1	150	11.1	150	8.8	150	6.2	150	4	150
AL-RTFD-35-0000-HD-NA	19.7	150	15.4	150	12.5	150	11.2	150	8.4	150	5.9	150
AL-RTFD-35-0000-ED-NA	26.4	150	21	150	19.4	150	15.6	150	12	150	9	150

1. The total combined EPA and weight of all fixtures, brackets and attachments mounting to a light pole cannot exceed the EPA and weight rating for a specified pole.
2. Standard EPA (Effective Projected Area) and weight values are based on AASHTO Standards and Florida Building Code. Contact factory for specific design criteria.
3. Satisfactory performance of light poles is dependent upon the pole being properly attached to a supporting foundation of adequate design.

Note: Additional sizes and configurations are available upon request.



206 W. McWilliams St.
Fond du Lac, WI 54935

800-558-4810
quotes@nafcointernational.com
NAFCOmf.com



Rev. V05102018

This specification brochure is intended to serve as a general guide. Our products are continually being engineered and improved, and specifications are subject to change without notice.



Designation & Dimensional Information

BASE MODEL	NOMINAL MOUNTING HEIGHT (ABOVE GRADE)	WALL THICKNESS	EMBEDMENT DEPTH (BELOW GRADE)
AL-RTFD-10-0000-SD-NA	10'-0"	Standard Duty	4'-0"
AL-RTFD-10-0000-ID-NA	10'-0"	Intermediate Duty	4'-0"
AL-RTFD-10-0000-HD-NA	10'-0"	Heavy Duty	4'-0"
AL-RTFD-10-0000-ED-NA	10'-0"	Extra Duty	4'-0"
AL-RTFD-12-0000-SD-NA	12'-0"	Standard Duty	4'-0"
AL-RTFD-12-0000-ID-NA	12'-0"	Intermediate Duty	4'-0"
AL-RTFD-12-0000-HD-NA	12'-0"	Heavy Duty	4'-0"
AL-RTFD-12-0000-ED-NA	12'-0"	Extra Duty	4'-0"
AL-RTFD-14-0000-SD-NA	14'-0"	Standard Duty	4'-0"
AL-RTFD-14-0000-ID-NA	14'-0"	Intermediate Duty	4'-0"
AL-RTFD-14-0000-HD-NA	14'-0"	Heavy Duty	4'-0"
AL-RTFD-14-0000-ED-NA	14'-0"	Extra Duty	4'-0"
AL-RTFD-16-0000-SD-NA	16'-0"	Standard Duty	4'-0"
AL-RTFD-16-0000-ID-NA	16'-0"	Intermediate Duty	4'-0"
AL-RTFD-16-0000-HD-NA	16'-0"	Heavy Duty	4'-0"
AL-RTFD-16-0000-ED-NA	16'-0"	Extra Duty	4'-0"
AL-RTFD-18-0000-SD-NA	18'-0"	Standard Duty	4'-0"
AL-RTFD-18-0000-ID-NA	18'-0"	Intermediate Duty	4'-0"
AL-RTFD-18-0000-HD-NA	18'-0"	Heavy Duty	4'-0"
AL-RTFD-18-0000-ED-NA	18'-0"	Extra Duty	4'-0"
AL-RTFD-20-0000-SD-NA	20'-0"	Standard Duty	4'-0"
AL-RTFD-20-0000-ID-NA	20'-0"	Intermediate Duty	4'-0"
AL-RTFD-20-0000-HD-NA	20'-0"	Heavy Duty	4'-0"
AL-RTFD-20-0000-ED-NA	20'-0"	Extra Duty	4'-0"
AL-RTFD-22-0000-SD-NA	22'-0"	Standard Duty	4'-0"
AL-RTFD-22-0000-ID-NA	22'-0"	Intermediate Duty	4'-0"
AL-RTFD-22-0000-HD-NA	22'-0"	Heavy Duty	4'-0"
AL-RTFD-22-0000-ED-NA	22'-0"	Extra Duty	4'-0"
AL-RTFD-23-0000-SD-NA	23'-0"	Standard Duty	5'-0"
AL-RTFD-23-0000-ID-NA	23'-0"	Intermediate Duty	5'-0"
AL-RTFD-23-0000-HD-NA	23'-0"	Heavy Duty	5'-0"
AL-RTFD-23-0000-ED-NA	23'-0"	Extra Duty	5'-0"
AL-RTFD-25-0000-SD-NA	25'-0"	Standard Duty	5'-0"
AL-RTFD-25-0000-ID-NA	25'-0"	Intermediate Duty	5'-0"
AL-RTFD-25-0000-HD-NA	25'-0"	Heavy Duty	5'-0"
AL-RTFD-25-0000-ED-NA	25'-0"	Extra Duty	5'-0"
AL-RTFD-27-0000-SD-NA	27'-0"	Standard Duty	5'-0"
AL-RTFD-27-0000-ID-NA	27'-0"	Intermediate Duty	5'-0"
AL-RTFD-27-0000-HD-NA	27'-0"	Heavy Duty	5'-0"
AL-RTFD-27-0000-ED-NA	27'-0"	Extra Duty	5'-0"
AL-RTFD-30-0000-SD-NA	30'-0"	Standard Duty	5'-0"
AL-RTFD-30-0000-ID-NA	30'-0"	Intermediate Duty	5'-0"
AL-RTFD-30-0000-HD-NA	30'-0"	Heavy Duty	5'-0"
AL-RTFD-30-0000-ED-NA	30'-0"	Extra Duty	5'-0"
AL-RTFD-32-0000-SD-NA	32'-0"	Standard Duty	5'-0"
AL-RTFD-32-0000-ID-NA	32'-0"	Intermediate Duty	5'-0"
AL-RTFD-32-0000-HD-NA	32'-0"	Heavy Duty	5'-0"
AL-RTFD-32-0000-ED-NA	32'-0"	Extra Duty	5'-0"
AL-RTFD-35-0000-SD-NA	35'-0"	Standard Duty	5'-0"
AL-RTFD-35-0000-ID-NA	35'-0"	Intermediate Duty	5'-0"
AL-RTFD-35-0000-HD-NA	35'-0"	Heavy Duty	5'-0"
AL-RTFD-35-0000-ED-NA	35'-0"	Extra Duty	5'-0"

- The total combined EPA and weight of all fixtures, brackets and attachments mounting to a light pole cannot exceed the EPA and weight rating for a specified pole.
- Standard EPA (Effective Projected Area) and weight values are based on AASHTO Standards and Florida Building Code. Contact factory for specific design criteria.
- Satisfactory performance of light poles is dependent upon the pole being properly attached to a supporting foundation of adequate design.

Note: Additional sizes and configurations are available upon request.



206 W. McWilliams St.
Fond du Lac, WI 54935

800-558-4810
quotes@nafcointernational.com
NAFCOmfg.com



Rev. V05102018

This specification brochure is intended to serve as a general guide. Our products are continually being engineered and improved, and specifications are subject to change without notice.



Job Name:
CHICKASAW SELF STORAGE
Engineer: LIGHTING PARTNERS /
ENGINEER (ORLANDO)

Catalog Number:
AL-RTFD-25-0000-SD-BK-D1

Notes:

Type:
POLES

LP21-21975

Ordering Information

Ex. AL-RTFD-14-0000-SD-NA-MB-D1-FST

Specify Finish

Designation AL-RTFD = Round Tapered Fiberglass Direct Burial	Mounting Height* 14 to 35 25	0000	Thickness SD = Standard Duty ID = Intermediate Duty HD = Heavy Duty ED = Extra Duty	Finish NA = Natural SM = Smooth	Painted Color MB = Bronze GR = Gray BK = Black WH = White GN = Green SC = Custom	Fixture Mounting Drill Mounting (includes cap) D1 = Single D2 = 2@180 deg. D3 = 3@120 deg. D4 = 4@90 deg. D5 = 2@90 deg. D6 = 3@90 deg. CD = Custom Drilling Tenon Mounting P2 = 2.38" OD x 4" Long Tenon P5 = 2.88" OD x 4" Long Tenon PD = 3" OD x 3" Long Tenon P9 = Custom Size Tenon Other Options PC = Top Cap Only, No Side Drilling
--	--	-------------	--	--	--	--

* See previous pages for base model configurations.
Consult factory or your sales rep for deviations from base models.
Additional sizes and configurations available upon request.

Options & Accessories

Description
SPL = Special Cut Length (Please Specify)
FST = Festoon Provision, Electrical by Others (Specify Pole Height & Orientation)
EHH = Additional Hand Hole Opening w/ Cover Assembly (Specify Pole Height & Orientation)
STAMP = Engineering Services, Signed & Sealed Calcs, Cost per Design/Revision

Note: Please consult factory or your sales representative to verify options and accessories will work with your light pole part number.



206 W. McWilliams St.
Fond du Lac, WI 54935
800-558-4810
quotes@nafcointernational.com
NAFCOmf.com



Rev. V05102018

This specification brochure is intended to serve as a general guide. Our products are continually being engineered and improved, and specifications are subject to change without notice.



Job Name:
CHICKASAW SELF STORAGE
Engineer: LIGHTING PARTNERS /
ENGINEER (ORLANDO)

Catalog Number:
T219LED-BL-10-10-BK-40-G2

Type:
UD

Notes:

LP21-21975



T219LED

BI - DIRECTIONAL LED CYLINDER
WALL LUMINAIRE

JOB INFORMATION	TYPE:
	CATALOG NO.
	PROJECT NAME:
	PREPARED BY:

DIMENSIONS

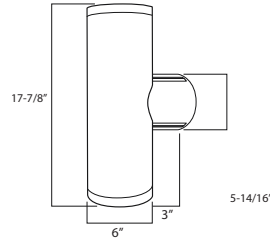

FEATURES

USE OF PRODUCT

The intended use of this product is for wall wash luminaires and/or directional lighting for commercial, retail, or architectural applications.

HOUSING

Rugged die cast aluminum housing.

FINISH

Architectural black powdercoat over a precise chromate conversion coating. Consult factory for made to order architectural finishes.

OPTICS

Anodized aluminum reflector with 36° beam angle. Clear tempered glass lens for impact resistance. Fixture available in either up light, down light, or bi-directional configuration. Lens is sealed by a one-piece silicon gasket, which prohibits entrance of outside contaminants.

LED

High output LEDs offer a minimum estimated operating life of 50,000 hours in 3000K, 3500K, 4000K, or 5000K (standard) with CRI>83. LEDs placed on high performance aluminum heatsink for reduced junction temperatures and extended life.

DRIVER

Durable and long lasting LED driver operates at 120-277V and boasts a 90% power factor at 50 to 60 Hz with 0-10V Dimming Constant Current. Driver protections includes: Output open load, over-current and short-circuit, and over-temperature with auto recovery. 40°C Min Temp. 40°C Max Temp. Step down transformer may be utilized for 480V or 347V applications.

MOUNTING

Luminaire may be mounted over a 4" recessed outlet box.

EPA

Effective Projected Area (Sq. Ft.): 0.633 ft²

LISTINGS/COMPLIANCE

- CEC Compliant emergency driver
- CSA - Suitable for wet location.
- Meets Dark Sky Compliancy in down light configuration only.

LIGHT CONFIGURATION

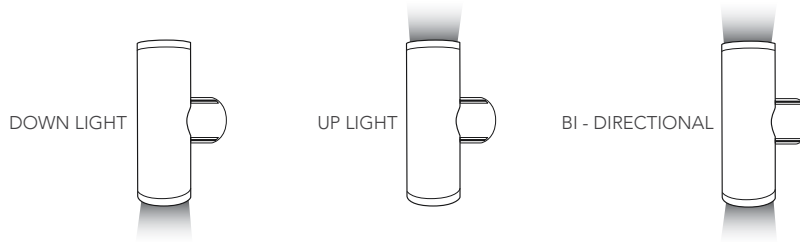

ORDERING INFO

NEXT PAGE





Job Name:
CHICKASAW SELF STORAGE
Engineer: LIGHTING PARTNERS /
ENGINEER (ORANDO)

Catalog Number:
T219LED-BL-10-10-BK-40-G2

Type:
UD

Notes:

LP21-21975



JOB INFORMATION

TYPE: _____

CATALOG NO. _____

PROJECT NAME: _____

COMMENTS: _____

PREPARED BY: _____

DOWN-LIGHT ORDERING INFORMATION

SERIES	CONFIGURATION	WATT/LUMENS	VOLTAGE	COLOR TEMP	OPTICS	FINISH	GENERATION
T-SERIES LED	DL - Down-Light	12 - 12W/1050	UNV - 120V-277V	30 - 3000K	36 ³ - 36°	B ⁴ - Black	G2 - 2nd Generation
		20 - 20W/1890	347 ¹ - 347V	35 - 3500K	15 - 15°	MTO ⁵ - Made to Order	
		30 - 30W/3150	480 ¹ - 480V	40 - 4000K		MGTO ⁵ - Marin Grade made to Order	
		45 - 45W/4725		50 ² - 5000K			
		58 - 58W/5738					

OPTIONS	WIRELESS CONTROL
PC1 - Photocell 120V PC2 - Photocell 277V MS - Motion Sensor external SP10 - Surge protection 10KV LPL - PIR sensor (low 8' mounting) LPM - PIR sensor (low 20' mounting) LPF - Radio module PCB assembly	LPH - Limelight by Lutron Integral module with PIR sensor and external antennae, - High mounting height LPM - Limelight by Lutron Integral module with PIR sensor and external antennae - Medium mounting height LPL - Limelight by Lutron Integral module with PIR sensor and external antennae - Low mounting height LRF - Limelight by Lutron Integral module with external antennae, RF Only

1. Stepdown transformer included.
2. Standard color temperature.
3. Standard Optic.
4. Standard Finish.
5. RAL number required

UP-LIGHT ORDERING INFORMATION

SERIES	CONFIGURATION	WATT/LUMENS	VOLTAGE	COLOR TEMP	OPTICS	FINISH	GENERATION
T-SERIES LED	UL - Up-Light	12 - 12W/1050	UNV - 120V-277V	30 - 3000K	36 ³ - 36°	B ⁴ - Black	G2 - 2nd Generation
		20 - 20W/1890	347 ¹ - 347V	35 - 3500K	15 - 15°	MTO ⁵ - Made to Order	
		30 - 30W/3150	480 ¹ - 480V	40 - 4000K		MGTO ⁵ - Marin Grade made to Order	
		45 - 45W/4725		50 ² - 5000K			
		58 - 58W/5738					

OPTIONS	WIRELESS CONTROL
PC1 - Photocell 120V PC2 - Photocell 277V MS - Motion Sensor external SP10 - Surge protection 10KV LPL - PIR sensor (low 8' mounting) LPM - PIR sensor (low 20' mounting) LPF - Radio module PCB assembly	LPH - Limelight by Lutron Integral module with PIR sensor and external antennae, - High mounting height LPM - Limelight by Lutron Integral module with PIR sensor and external antennae - Medium mounting height LPL - Limelight by Lutron Integral module with PIR sensor and external antennae - Low mounting height LRF - Limelight by Lutron Integral module with external antennae, RF Only

1. Stepdown transformer included.
2. Standard color temperature.
3. Standard Optic.
4. Standard Finish.
5. RAL number required

Specify Voltage

BI-DIRECTIONAL ORDERING INFORMATION

SERIES	CONFIGURATION	UP LIGHT WATT/LUMENS ¹	DOWN LIGHT WATT/LUMENS ¹	VOLTAGE	COLOR TEMP	UP-LIGHT OPTICS	DOWN-LIGHT OPTICS
T-SERIES LED	BL - Bi-Directional	12 ¹ - 12W/1050	12 ¹ - 12W/1050	UNV - 120V-277V	30 - 3000K	36 ⁴ - 36°	36 ⁴ - 36°
		20 ¹ - 20W/1890	20 ¹ - 20W/1890	347 ² - 347V	35 - 3500K	15 - 15°	15 - 15°
		30 ¹ - 30W/3150	30 ¹ - 30W/3150	480 ² - 480V	40 - 4000K		
		45 ¹ - 45W/4725	45 ¹ - 45W/4725		50 ³ - 5000K		

FINISH	GENERATION	OPTIONS	WIRELESS CONTROL
B ⁵ - Black MTO ⁶ - Made to Order MGTO ⁶ - Marin Grade made to Order	G2 - 2nd Generation	PC1 - Photocell 120V PC2 - Photocell 277V MS - Motion Sensor external SP10 - Surge protection 10KV	LPH - Limelight by Lutron Integral module with PIR sensor and external antennae, - High mounting height LPM - Limelight by Lutron Integral module with PIR sensor and external antennae - Medium mounting height LPL - Limelight by Lutron Integral module with PIR sensor and external antennae - Low mounting height LRF - Limelight by Lutron Integral module with external antennae, RF Only

1. Maximum total system wattage shall not exceed 60W
2. Stepdown transformer included
3. Standard color temperature
4. Standard Optic
5. Standard Finish
6. RAL number required





Job Name:
CHICKASAW SELF STORAGE
Engineer: LIGHTING PARTNERS /
ENGINEER (ORANDO)

Catalog Number:
T219LED-BL-10-10-BK-40-G2

Notes:

Type:

UD

LP21-21975

TECH-D

B-U-G RATING

Up-Light or Down-Light			
Model Number	Wattage	4000K	
T219LED-10	10.34	1154	Lumen
		112	Efficacy
		B1-U2-G0	B-U-G Rating
T219LED-18	21.2	2308	Lumen
		109	Efficacy
		B2-U2-G0	B-U-G Rating
T219LED-30	28.9	3116	Lumen
		105	Efficacy
		B2-U2-G0	B-U-G Rating
T219LED-45	43.9	4616	Lumen
		105	Efficacy
		B3-U3-G0	B-U-G Rating
T219LED-58	54.4	5655	Lumen
		104	Efficacy
		B3-U3-G0	B-U-G Rating

Up-Light and Down-Light			
Model Number	Wattage	4000K	
T219LED-10-10	20.68	2190	Lumen
		106	Efficacy
		B1-U5-G0	B-U-G Rating
T219LED-18-18	42.4	4380	Lumen
		103	Efficacy
		B2-U5-G0	B-U-G Rating
T219LED-30-30	57.8	5782	Lumen
		100	Efficacy
		B2-U5-G0	B-U-G Rating

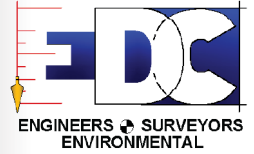

April 29, 2021

Flagship Companies Group, LLC
Attn: Phillip C. Hollis, MS/PE
1190 Business Center Drive, Ste. 2000
Lake Mary, FL 32746

VIA Email: phillip@pmjs.com

Reference: Tree Inventory
S Jenkins Road
Fort Pierce, St. Lucie County, FL
Parcel IDs: 2419-603-0003-000-4; 2419-603-0004-000-1

Prepared by: Anthony A. Adams
International Society of Arboriculture Certified Arborist FL-9472A

Certification of Performance

I, Anthony A. Adams, certify to the best of my knowledge, and abilities:

That I have personally inspected the tree(s) and or the property referred to in this report.

That it is my professional opinion, that the following report is true, and the conclusions and results stated are correct based on the information received about the property evaluated and the evaluation methods followed.

That the reported analyses, opinions, and conclusions are only limited by the reported assumptions, methods and limiting conditions and my personal, unbiased professional analyses, opinions and conclusions.

That EDC, Inc. acts as an independent tree, and environmental consultant.

That this Report, or parts of this Report, have not been revealed to any party other than the Client named and will not be revealed to any other party unless authorized to do so by Client named or by due process of law or by legally required public testimony by this firm of these results.

This report is written in good faith and all rights are reserved by EDC, Inc. It is for use by the client named only.

A handwritten signature in black ink, appearing to read 'Anthony A. Adams', written over a horizontal line.

Signature: _____

Date: 04/29/2021

REPORT

I. Introduction

This Report is written for Phillip C. Hollis, MS/PE. It is based on information gained through the most recent site visit, to provide values to the trees, located on the referenced properties. This is currently an undeveloped property that was formerly a homestead; there was a small area of row crops seen on older aerials, and other trees and palms grew in naturally since that point in time. A formal site visit to review the trees was performed on April 23, 2021.

II. Property Involved

The subject parcels involved are located at the NE Corner of S. Jenkins Road and Okeechobee Boulevard, Fort Pierce, St. Lucie County, FL. The trees are located throughout both properties. This Tree Report includes only the listed trees on the subject parcels. The Environmental Assessment attached addresses other environmental concerns such as listed species presence, wetlands, soils, and other vegetation.

III. Data Collection

The property/trees were evaluated by site visit to determine environmental conditions. This appraisal is based on value of subject as per ISA "Rule 14-40.030, Florida Administrative Code"..

IV. Limiting Conditions

This "Arboriculture Report" includes only the listed trees, landscape conditions in the immediate area where the tree is located, and conditions caused by or attributable to the trees on this property.

Limits of the Assignment

1. This report is not intended as and does not represent legal advice and should not be relied upon to take the place of such advice.
2. This report is limited to documenting the condition of the tree on the dates given. Care has been taken to obtain all information from reliable sources. All data has been verified insofar as possible; however, the consultant can neither guarantee nor be responsible for the accuracy of information provided by others.
3. Loss or alteration of any part of this report invalidates the entire report.
4. Sketches and photographs used in this report are intended as visual aids only and are not necessarily to scale.

Appendix A

Tree Photographs



1. – Tree #8 exhibiting unhealthy lean, developing “catface”.



2. – Tree #15 with included bark, hollowing out at branch joints.



3. – Tree #17, on the right, dying palm trunk.



4. – Tree #53, Laurel Oak, near debris with failing codominant stems.



5. – Tree #53 cont'd, with hollowed trunk.



Environmental Assessment

Jenkins Road
Fort Pierce, St. Lucie County, FL

Tree Location Map

Project: 21-241

Flagship Companies

08/05/2021

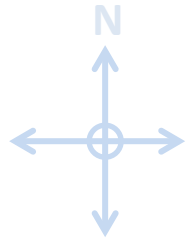

Column1	Column2	Column3	Column5
Number	Common Name	DBH	Scientific Name
1	Palm		<i>Sabal palmetto</i>
2	Palm		<i>Sabal palmetto</i>
3	Laurel	19.7	<i>Quercus laurifolia</i>
4	Pine	14.2	<i>Sabal palmetto</i>
5	Palm		<i>Sabal palmetto</i>
6	Palm		<i>Sabal palmetto</i>
7	Pine	15.1	<i>Sabal palmetto</i>
9	Palm		<i>Sabal palmetto</i>
10	Palm		<i>Sabal palmetto</i>
11	Palm		<i>Sabal palmetto</i>
12	Palm		<i>Sabal palmetto</i>
13	Palm		<i>Sabal palmetto</i>
14	Palm		<i>Sabal palmetto</i>
15	Laurel	26.5	<i>Quercus laurifolia</i>
16	Palm		<i>Sabal palmetto</i>
18	Palm		<i>Sabal palmetto</i>
19	Palm		<i>Sabal palmetto</i>
20	Palm		<i>Sabal palmetto</i>
21	Palm		<i>Sabal palmetto</i>
22	Palm		<i>Sabal palmetto</i>
23	Palm		<i>Sabal palmetto</i>
24	Palm		<i>Sabal palmetto</i>
25	Palm		<i>Sabal palmetto</i>
26	Laurel	13.8	<i>Quercus laurifolia</i>
27	Laurel	22.5	<i>Quercus laurifolia</i>
28	Palm		<i>Sabal palmetto</i>
30	Palm		<i>Sabal palmetto</i>
31	Palm		<i>Sabal palmetto</i>
32	Palm		<i>Sabal palmetto</i>
33	Palm		<i>Sabal palmetto</i>
34	Palm		<i>Sabal palmetto</i>
35	Palm		<i>Sabal palmetto</i>
36	Palm		<i>Sabal palmetto</i>
37	Palm		<i>Sabal palmetto</i>
38	Palm		<i>Sabal palmetto</i>
39	Palm		<i>Sabal palmetto</i>
40	Palm		<i>Sabal palmetto</i>
41	Palm		<i>Sabal palmetto</i>
42	Palm		<i>Sabal palmetto</i>
43	Palm		<i>Sabal palmetto</i>
44	Palm		<i>Sabal palmetto</i>
45	Laurel	17.4	<i>Quercus laurifolia</i>
46	Pine	17	<i>Sabal palmetto</i>
47	Laurel	20.9	<i>Quercus laurifolia</i>
48	Laurel	15.5	<i>Quercus laurifolia</i>
49	Palm		<i>Sabal palmetto</i>
50	Laurel	25.5	<i>Quercus laurifolia</i>
51	Palm		<i>Sabal palmetto</i>
52	Palm		<i>Sabal palmetto</i>
54	Palm		<i>Sabal palmetto</i>
55	Laurel	19.2	<i>Quercus laurifolia</i>
56	Live	21	<i>Quercus virginiana</i>
57	Live	15.1	<i>Quercus virginiana</i>
58	Live	16	<i>Quercus virginiana</i>
59	Laurel	23.5	<i>Quercus laurifolia</i>
60	Laurel	14.3	<i>Quercus laurifolia</i>
61	Laurel	15.1	<i>Quercus laurifolia</i>
62	Laurel	19.5	<i>Quercus laurifolia</i>
63	Palm		<i>Sabal palmetto</i>
64	Palm		<i>Sabal palmetto</i>
65	Palm		<i>Sabal palmetto</i>
66	Palm		<i>Sabal palmetto</i>
67	Palm		<i>Sabal palmetto</i>
68	Palm		<i>Sabal palmetto</i>
69	Palm		<i>Sabal palmetto</i>
70	Palm		<i>Sabal palmetto</i>
71	Palm		<i>Sabal palmetto</i>
72	Laurel	16.2	<i>Quercus laurifolia</i>
73	Palm		<i>Sabal palmetto</i>
74	Palm		<i>Sabal palmetto</i>
75	Palm		<i>Sabal palmetto</i>
76	Palm		<i>Sabal palmetto</i>
77	Palm		<i>Sabal Palmetto</i>
78	Palm		<i>Sabal palmetto</i>

TRAFFIC IMPACT ANALYSIS

For

Flagship Storage – Jenkins Road

Prepared By: Deanna Foriere, EI

Engineering Design & Construction, Inc.

10250 SW Village Parkway, Suite 201

Port St. Lucie, FL 34987

Board of Professional Engineers Certificate of Authorization Number 9935

September 2021

Marci D Chandler , P.E.

Date

#63034

10250 SW Village Parkway, Suite 201

Table of Contents

Introduction:	2
Project Description:	2
Existing Condition:.....	2
Trip Generation:	3
Internal Capture:	3
Pass-by Trip Capture:	3
Traffic Distribution:	4
Level of Service & Build-out Analysis	4
Intersection/Driveway Analysis.....	4
Conclusion:	4
Exhibit 1: Location Map.....	5
Exhibit 2: Site Plan.....	7
Exhibit 3: Distribution Map	9
Exhibit 4: LOS Analysis.....	11
Exhibit 5: Driveway Map.....	13
Supporting Documents	15

Introduction:

Engineering Design & Construction has completed a traffic statement and impact analysis for a proposed commercial development, located North of Okeechobee Rd on Jenkins Rd in Fort Pierce, FL. See the attached Location Map (Exhibit 1).

The purpose of this study is to determine the proposed project's impact on the surrounding traffic and roadway level of service. This analysis follows the guidelines set forth in the Sec. 105-5(f)(2)(b) of the Fort Pierce Land Development Code, along with the St Lucie TPO Traffic Impact Methodology and Procedures.

Project Description:

The project is located on parcels 2419-603-0003-000-4 & 2419-603-0004-000-1, and approximately 730' from the signalized intersection of Okeechobee Rd (SR-70) and S Jenkins Rd with a total site area of 4.73 AC. The proposed project consists of 3 self-storage buildings and a covered parking area, the gross square footage is 112,100 S.F. Please see Exhibit 2 for the proposed site plan.

Existing Condition:

The existing lot is undeveloped and is located adjacent to the existing Walgreens on the corner of Okeechobee Rd and S Jenkins Rd. Okeechobee Rd is an eight-lane divided state road, running NE with a speed limit of 45mph. The proposed project is located on S Jenkins Rd a four-lane divided road with a speed limit of 45mph. The proposed project site is connecting to an existing access with a full median opening. Current construction on Jenkins Rd has installed right and left turn lane into the existing access. All existing traffic was collected by St. Lucie County TPO Traffic Counts and Level of Service Report (Fall/Winter 2019/2020)

Trip Generation:

To properly estimate the trip generation the Institute of Traffic Engineers' (ITE) Report, Trip Generation (10th edition) was used to produce Daily Average, A.M Peak, and P.M. Peak Hour Trips. The proposed development is a self-storage location with an overall ±105,400 S.F. of storage space (151 ITE Code) and ±6,700 S.F. of Office Space (710 ITE Code)

FLAGSHIP STORAGE									
Institute of Transportation Engineers: Trip Generation, 10th Edition									
WEEKDAY: DAILY AVERAGE									
Land Use	ITE Code	Intensity	Units	Trip Generation Rate	Directional Split		Gross Trips		
					IN	OUT	IN	OUT	TOTAL
Mini -Warehouse	151	105,410	S.F.	$T=1.51(X/1000)$	50%	50%	80	80	159
Office	710	6,690	S.F.	$\ln(T)=0.97\ln(X/1000)+2.50$	50%	50%	38	38	77
Total							118	118	236
WEEKDAY: A.M. PEAK HOUR TRIPS									
Land Use	ITE Code	Intensity	Units	Trip Generation Rate	Directional Split		Gross Trips		
					IN	OUT	IN	OUT	TOTAL
Mini -Warehouse	151	105410	S.F.	$T=0.20(X/1000)$	50%	50%	11	11	21
Office	710	6,690	S.F.	$\ln(T)=0.88\ln(X/1000)+1.06$	88%	12%	14	2	15
Total							24	12	36
WEEKDAY: P.M. PEAK HOUR TRIPS									
Land Use	ITE Code	Intensity	Units	Trip Generation Rate	Directional Split		Gross Trips		
					IN	OUT	IN	OUT	TOTAL
Mini -Warehouse	151	105410	S.F.	$T=0.20(X/1000)$	51%	49%	11	10	21
Office	710	6,690	S.F.	$T=1.42(X/1000)$	18%	82%	4	20	25
Total							15	31	46

Internal Capture:

This project contains no internal capture

Pass-by Trip Capture:

This project contains no pass by trips

Traffic Distribution:

Traffic Distribution and assignment was determined using engineering judgement, trip lengths, surrounding uses and review of the roadway network. Per section 105-5(f)(2) Table A a 2 mile radius of impact is used. The general distribution can be seen below. Detailed distribution map is attached in Exhibit 3.

North =15%
South =85%

Table A. Radius of Impact for Transportation Concurrency Management System

Minimal Scale	Trips 9—50	1.0 Mile Radius
Small Scale	Trips 51—100	1.5 Mile Radius
Intermediate Scale	Trips 101—500	2.0 Mile Radius
Medium Scale	Trips 501—1000	3.0 Mile Radius
Large Scale	Trips 1000—Up	5.0 Mile Radius

Level of Service & Build-out Analysis

The effected roads within the 2 mile radius are analyzed at the predicted build out year (2023) using the St. Lucie TPO growth rate, added to the existing peak hr capacity. The proposed project trips are compared to predicted build out road capacity and compared to the Road's Level of Service(LOS) capacity to confirm no negative impacts are created by development. Please find the attached LOS Analysis in Exhibit 4.

Intersection/Driveway Analysis

Find the attached driveway analysis with detailed right and left turns in Exhibit 5.

Conclusion:

In conclusion the proposed self-storage development with a total area of ±112,000 S.F. and has a net change in traffic of 236 daily trips with 36 AM Peak Hour Trips, and 46 PM Peak Hour Trips. Analysis of the distribution of trips along the major roads were presented with no LOS exceeded. All roads analyzed were projected to the proposed build out date with the roads growth rate provided by St. Lucie TPO. Because of this, it is EDC belief that this development will have no adverse effects on the surrounding roads.

Exhibit 1: Location Map

Supporting Documents

Traffic Counts and Level of Service Report
Fall/Winter 2019/2020

Roadway Name	Location	STATION ID	AADT	Last Count Year	Pk Hr Service Capacity	AM Pk Hr Pk Dir			PM Pk Hr Pk Dir		
						Volume	LOS	V/C	Volume	LOS	V/C
GEORGIA AVE	OKEECHOBEE RD to 17TH ST	667	4,700	2020	750	290	C	0.784	262	C	0.708
GEORGIA AVE	17TH ST to 13TH ST	508	4,733	2019	600	264	C	0.880	268	C	0.893
GEORGIA AVE	13TH ST to 7TH ST	506	2,169	2019	600	134	C	0.447	137	C	0.457
GEORGIA AVE	7TH ST to US 1	504	1,938	2019	600	122	C	0.407	135	C	0.450
GILSON RD	MARTIN C.L. to BECKER RD	111	11,000	2019	710	949	F	1.249	954	F	1.255
GILSON RD	BECKER RD to LAKERIDGE DR	111	11,000	2019	540	949	F	1.636	954	F	1.645
GLADES CUT-OFF RD	RANGE LINE RD to RESERVE BLVD	668	2,833	2017	1,070	200	B	0.526	252	B	0.663
GLADES CUT-OFF RD	RESERVE BLVD to COMMERCE CENTER DR	119	3,585	2016	1,070	332	B	0.874	332	B	0.874
GLADES CUT-OFF RD	CARLTON RD to RANGE LINE RD	668	2,833	2017	390	200	B	0.909	252	C	0.646
GLADES CUT-OFF RD	COMMERCE CENTER DR to MIDWAY RD	940279	2,800	2019	920	213	C	0.245	194	C	0.223
GLADES CUT-OFF RD	MIDWAY RD to JENKINS RD	115	12,500	2020	790	669	D	0.847	687	D	0.870
GLADES CUT-OFF RD	JENKINS RD to SELVITZ RD	113	6,600	2020	830	370	C	0.474	385	C	0.494
GRAHAM RD	KINGS HWY to JENKINS RD	669	3,733	2017	630	255	C	0.425	243	C	0.405
GREEN RIVER PKWY	MARTIN C.L. to CHARLESTON DR	319	4,759	2018	1,070	337	B	0.887	332	B	0.874
GREEN RIVER PKWY	CHARLESTON DR to MELALEUCA BLVD	319	4,759	2018	1,070	337	B	0.887	332	B	0.874
GREEN RIVER PKWY	MELALEUCA BLVD to WALTON RD	319	4,759	2018	1,070	337	B	0.887	332	B	0.874
HARTMAN RD	OKEECHOBEE RD to PETERSON RD	670	5,867	2017	750	388	D	0.517	357	C	0.965
HARTMAN RD	PETERSON RD to DELAWARE AVE	670	5,867	2017	540	388	D	0.719	357	D	0.661
HARTMAN RD	DELAWARE AVE to ORANGE AVE	670	5,867	2017	790	388	C	0.995	357	C	0.915
HEADER CANAL RD	OKEECHOBEE RD to ORANGE AVE	121	560	2019	670	46	B	0.209	56	B	0.255
HILLMOOR DR	US 1 to LENNARD RD	671	5,900	2019	790	306	C	0.785	389	C	0.997
I-95	GATLIN BLVD to ST LUCIE WEST BLVD	941901	83,500	2019	4,580	4,276	C	0.934	3,862	C	0.843
I-95	ST LUCIE WEST BLVD to MIDWAY RD	941904	65,469	2018	4,580	3,682	C	0.804	3,175	B	0.945
I-95	MIDWAY RD to OKEECHOBEE RD	941902	77,647	2018	4,580	4,687	D	0.852	3,806	C	0.831
I-95	OKEECHOBEE RD to ORANGE AVE	940260	65,918	2019	7,320	2,789	B	0.620	2,789	B	0.620

* Note: A six digit number in the "STATION ID" column identifies segment counted by FDOT
 * Volumes shown were adjusted using FDOT Seasonal Factors
 * AADT = Annual Average Daily Traffic (volumes for both directions where applicable)
 * Counts with an ID format of 6 digits have data extracted from FDOT count stations.

Traffic Counts and Level of Service Report
Fall/Winter 2019/2020

Roadway Name	Location	STATION ID	AADT	Last Count Year	Pk Hr Service Capacity	AM Pk Hr Pk Dir			PM Pk Hr Pk Dir		
						Volume	LOS	V/C	Volume	LOS	V/C
I-95	ORANGE AVE to INDRIO RD	941905	57,000	2019	7,320	2,742	B	0.609	2,524	B	0.561
INDIAN RIVER DR	CITRUS AVE to ORANGE AVE	945029	6,800	2019	750	405	D	0.540	463	D	0.617
INDIAN RIVER DR	ORANGE AVE to AVENUE A	940003	5,600	2019	750	327	C	0.884	318	C	0.859
INDIAN RIVER DR	AVENUE D to SEAWAY DR	940004	7,400	2019	790	433	D	0.548	509	D	0.644
INDIAN RIVER DR	AVENUE A to AVENUE D	940004	7,400	2019	540	433	D	0.802	509	D	0.943
INDRIO RD	PRIVATE RD to I-95 W RAMP	940128	1,850	2019	1,080	135	B	0.329	146	B	0.356
INDRIO RD	I-95 W RAMP to I-95 E RAMP	940128	1,850	2019	3,240	135	B	0.075	146	B	0.081
INDRIO RD	I-95 E RAMP to KOBLEGARD RD	940038	10,200	2019	3,240	583	B	0.322	613	B	0.339
INDRIO RD	KOBLEGARD RD to JOHNSTON RD	940038	10,200	2019	700	583	C	0.883	613	C	0.929
INDRIO RD	JOHNSTON RD to EMERSON AVE	940038	10,200	2019	880	583	C	0.702	613	C	0.739
INDRIO RD	EMERSON RD to SEMINOLE RD	940281	11,200	2019	920	675	C	0.776	568	C	0.653
INDRIO RD	SEMINOLE RD to KINGS HWY	940281	11,200	2019	790	675	D	0.854	568	D	0.719
INDRIO RD	KINGS HWY to SLASH PINE TRL	114	6,600	2020	790	422	D	0.534	413	D	0.523
INDRIO RD	SLASH PINE TRL to US 1	114	6,600	2020	920	422	C	0.485	413	C	0.475
INDRIO RD	US 1 to OLD DIXIE HWY	672	917	2016	750	64	C	0.173	86	C	0.232
JENNINGS RD	US 1 to LENNARD RD	673	4,600	2016	2,100	304	C	0.151	248	C	0.123
JENKINS RD	EDWARDS RD to OKEECHOBEE RD	133	10,500	2020	880	549	C	0.661	553	C	0.666
JENKINS RD	OKEECHOBEE RD to GRAHAM RD	131	10,500	2020	920	593	C	0.682	569	C	0.654
JENKINS RD	GRAHAM RD to PETERSON RD	131	10,500	2020	630	593	C	0.988	569	C	0.948
JENKINS RD	PETERSON RD to ORANGE AVE	131	10,500	2020	920	593	C	0.682	569	C	0.654
JOHNSTON RD	ANGLE RD to L20	674	2,600	2016	1,070	176	B	0.463	171	B	0.450
JOHNSTON RD	L20 to MEADOWOOD DR	675	2,233	2017	1,070	142	B	0.374	138	B	0.363
JOHNSTON RD	MEADOWOOD DR to OLD JOHNSTON RD	675	2,233	2017	1,070	142	B	0.374	138	B	0.363
JOHNSTON RD	OLD JOHNSTON RD to INDRIO RD	675	2,233	2017	1,070	142	B	0.374	138	B	0.363
JOHNSTON RD	INDRIO RD to RUSSOS RD	135	9,600	2020	1,070	544	C	0.716	545	C	0.717

* Note: A six digit number in the "STATION ID" column identifies segment counted by FDOT
 * Volumes shown were adjusted using FDOT Seasonal Factors
 * AADT = Annual Average Daily Traffic (volumes for both directions where applicable)
 * Counts with an ID format of 6 digits have data extracted from FDOT count stations.

Traffic Counts and Level of Service Report Fall/Winter 2019/2020

Roadway Name	Location	STATION ID	AADT	Last Count Year	Pk Hr Service Capacity	AM Pk Hr Pk Dir			PM Pk Hr Pk Dir		
						Volume	LOS	V/C	Volume	LOS	V/C
JOHNSTON RD	RUSSOS RD to INDIAN RIVER C.L.	135	9,600	2020	1,070	544	C	0.716	545	C	0.717
JUANITA AVE	53RD ST to 25TH ST	122	2,432	2017	750	157	C	0.424	143	C	0.386
JUANITA AVE	25TH ST to US 1	120	3,321	2017	750	185	C	0.500	182	C	0.492
KEEN RD	ANGLE RD to JUANITA AVE	129	2,885	2019	630	174	C	0.290	203	C	0.338
KEEN RD	JUANITA AVE to ST LUCIE BLVD	129	2,885	2019	630	174	C	0.290	203	C	0.338
KINGS HWY	OKEECHOBEE RD to CROSSROADS PKWY	940757	7,600	2019	830	333	C	0.401	341	C	0.411
KINGS HWY	CROSSROADS PKWY to GRAHAM RD	940757	7,600	2019	660	333	C	0.505	341	C	0.517
KINGS HWY	GRAHAM RD to PICOS RD	940076	7,000	2019	660	345	C	0.523	331	C	0.502
KINGS HWY	PICOS RD to ORANGE AVE	940076	7,000	2019	830	345	C	0.416	331	C	0.399
KINGS HWY	ORANGE AVE to ANGLE RD	940077	13,900	2019	870	732	C	0.841	737	C	0.847
KINGS HWY	ANGLE RD to ST LUCIE BLVD	940751	13,100	2019	830	721	C	0.869	725	C	0.873
KINGS HWY	ST LUCIE BLVD to INDRIO RD	940006	14,900	2019	830	924	F	1.050	868	D	0.986
KITTERMAN RD	OLEANDER AVE to US 1	124	3,402	2018	750	224	C	0.605	203	C	0.549
KITTERMAN RD	US 1 to LENNARD EXT	678	2,250	2017	750	128	C	0.346	130	C	0.351
KIRBY LOOP RD	EDWARDS RD to 35TH ST	677	4,479	2016	630	296	C	0.493	362	C	0.603
LENNARD RD	US 1 to MARIPOSA AVE	325	18,500	2019	1,710	953	D	0.557	984	D	0.575
LENNARD RD	MARIPOSA AVE to MELALEUCA BLVD	325	18,500	2019	1,710	953	D	0.557	984	D	0.575
LENNARD RD	MELALEUCA BLVD to JENNINGS RD	325	18,500	2019	1,630	953	D	0.585	984	D	0.604
LENNARD RD	JENNINGS RD to HILLMOOR DR	325	18,500	2019	1,710	953	D	0.557	984	D	0.575
LENNARD RD	HILLMOOR DR to TIFFANY AVE	325	18,500	2019	1,710	953	D	0.557	984	D	0.575
LENNARD RD	TIFFANY AVE to WALTON RD	323	5,765	2016	1,710	301	C	0.391	305	C	0.396
LENNARD RD	WALTON RD to S OF SAVANNA CLUB BLVD	679	4,455	2016	790	390	C	10	381	C	0.977
LYNGATE DR	VETERANS MEMORIAL PKWY to MORNINGSIDE BLVD	306	9,400	2020	920	588	C	0.676	626	C	0.720
LYNGATE DR	MORNINGSIDE BLVD to US 1	306	9,400	2020	920	588	C	0.676	626	C	0.720
MARIPOSA AVE	LENNARD RD to HALLAHAN ST	166	6,400	2019	880	485	C	0.584	686	C	0.827

* Note: A six digit number in the "STATION ID" column identifies segment counted by FDOT
 * Volumes shown were adjusted using FDOT Seasonal Factors
 * AADT = Annual Average Daily Traffic (volumes for both directions where applicable)
 * Counts with an ID format of 6 digits have data extracted from FDOT count stations.

Traffic Counts and Level of Service Report
 Fall/Winter 2019/2020

Roadway Name	Location	STATION ID	AADT	Last Count Year	Pk Hr Service Capacity	AM Pk Hr Pk Dir			PM Pk Hr Pk Dir		
						Volume	LOS	V/C	Volume	LOS	V/C
OHIO AVE	SUNRISE BLVD to COLONIAL RD	686	4,250	2017	540	252	C	0.933	246	C	0.911
OHIO AVE	COLONIAL RD to US 1	686	4,250	2017	750	252	C	0.681	246	C	0.665
OKEECHOBEE RD	OKEECHOBEE C.L. to BLUEFIELD RD	687	10,500	2020	1,010	540	B	0.535	528	B	0.523
OKEECHOBEE RD	BLUEFIELD RD to CARLTON RD	687	10,500	2020	1,270	540	B	0.425	528	B	0.416
OKEECHOBEE RD	CARLTON RD to SNEED RD	940039	8,800	2019	1,340	469	B	0.350	458	B	0.342
OKEECHOBEE RD	IDEAL HOLDING RD to HEADER CANAL RD	940039	8,800	2019	1,340	469	B	0.350	458	B	0.342
OKEECHOBEE RD	SNEED RD to IDEAL HOLDING RD	940039	8,800	2019	1,340	469	B	0.350	458	B	0.342
OKEECHOBEE RD	HEADER CANAL RD to MIDWAY RD	940039	8,800	2019	1,740	469	B	0.270	458	B	0.263
OKEECHOBEE RD	MIDWAY RD to SHINN RD	940039	8,800	2019	1,740	469	B	0.270	458	B	0.263
OKEECHOBEE RD	SHINN RD to MCCARTY RD	940195	6,381	2019	1,810	346	B	0.191	346	B	0.191
OKEECHOBEE RD	MCCARTY RD to FLORIDA'S TURNPIKE	940025	8,400	2019	1,810	420	B	0.232	435	B	0.240
OKEECHOBEE RD	FLORIDA'S TURNPIKE to KINGS HWY	940025	8,400	2019	2,010	420	C	0.209	435	C	0.216
OKEECHOBEE RD	KINGS HWY to CROSSROADS PKWY	940748	26,000	2019	4,170	1,175	C	0.282	1,240	C	0.297
OKEECHOBEE RD	CROSSROADS PKWY to I-95	940106	32,500	2019	4,170	1,406	C	0.337	1,436	C	0.344
OKEECHOBEE RD	I-95 to JENKINS RD	940029	33,000	2019	4,240	2,156	C	0.517	1,865	C	0.447
OKEECHOBEE RD	JENKINS RD to MCNEIL RD	940029	33,000	2019	4,040	2,156	C	0.543	1,865	C	0.470
OKEECHOBEE RD	MCNEIL RD to VIRGINIA AVE	940742	30,500	2019	3,170	1,669	C	0.540	1,742	C	0.564
OKEECHOBEE RD	VIRGINIA AVE to HARTMAN RD	688	12,500	2020	2,100	687	C	0.342	727	C	0.362
OKEECHOBEE RD	HARTMAN RD to 35TH ST	688	12,500	2020	1,630	687	C	0.941	727	C	0.996
OKEECHOBEE RD	35TH ST to 33RD ST	689	17,000	2020	1,630	922	D	0.566	902	D	0.553
OKEECHOBEE RD	33RD ST to 25TH ST	689	17,000	2020	1,630	922	D	0.566	902	D	0.553
OKEECHOBEE RD	25TH ST to GEORGIA AVE	690	13,500	2020	1,630	777	D	0.477	738	D	0.453
OKEECHOBEE RD	GEORGIA AVE to DELAWARE AVE	690	13,500	2020	1,710	777	D	0.454	738	C	0.958
OLD DIXIE HWY	US 1 to SR A1A NORTH	691	5,150	2017	790	400	D	0.506	363	C	0.931
OLD DIXIE HWY	SR A1A NORTH to ST LUCIE BLVD	948521	1,750	2019	750	82	C	0.222	82	C	0.222

* Note: A six digit number in the "STATION ID" column identifies segment counted by FDOT
 * Volumes shown were adjusted using FDOT Seasonal Factors
 * AADT = Annual Average Daily Traffic (volumes for both directions where applicable)
 * Counts with an ID format of 6 digits have data extracted from FDOT count stations.



**Traffic Counts and Level of Service Report
Fall/Winter 2019/2020**

Roadway Name	Location	STATION ID	AADT	Last Count Year	Pk Hr Service Capacity	AM Pk Hr Pk Dir			PM Pk Hr Pk Dir		
						Volume	LOS	V/C	Volume	LOS	V/C
US 1	AVENUE H to OLD DIXIE HWY	715	33,500	2020	2,000	1,766	C	0.925	1,742	C	0.912
US 1	OLD DIXIE HWY to AVENUE O	940123	30,000	2019	2,000	2,082	F	1.041	1,628	C	0.852
US 1	AVENUE O to SR A1A NORTH	940123	30,000	2019	2,100	2,082	D	0.991	1,628	C	0.810
US 1	SR A1A NORTH to JUANITA AVE	940010	20,500	2019	2,100	1,230	C	0.612	985	C	0.490
US 1	JUANITA AVE to ST LUCIE BLVD	940010	20,500	2019	2,100	1,230	C	0.612	985	C	0.490
US 1	ST LUCIE BLVD to 25TH ST	940009	24,500	2019	2,100	1,459	C	0.726	1,399	C	0.696
US 1	25TH ST to INDRIO RD	940009	24,500	2019	2,100	1,459	C	0.726	1,399	C	0.696
US 1	INDRIO RD to TURNPIKE FEEDER RD	940107	24,500	2019	2,100	1,333	C	0.663	1,326	C	0.660
US 1	TURNPIKE FEEDER RD to INDIAN RIVER C.L.	940107	24,500	2019	2,100	1,333	C	0.663	1,326	C	0.660
VETERANS MEMORIAL PKWY	PORT ST LUCIE BLVD to LYNNGATE DR	329	14,500	2019	2,100	779	C	0.388	817	C	0.406
VETERANS MEMORIAL PKWY	LYNGATE DR to US 1	327	14,911	2017	2,100	756	C	0.376	804	C	0.400
VILLAGE GREEN DR	US 1 to WALTON RD	716	9,600	2017	2,100	619	C	0.308	575	C	0.286
VILLAGE GREEN DR	WALTON RD to TIFFANY AVE	717	4,633	2017	920	249	C	0.286	235	C	0.270
VIRGINIA AVE	35TH ST to 25TH ST	940032	23,000	2019	3,020	1,186	C	0.403	1,155	C	0.393
VIRGINIA AVE	OKEECHOBEE RD to HARTMAN RD	940030	21,000	2019	3,020	1,115	C	0.379	1,074	C	0.365
VIRGINIA AVE	HARTMAN RD to 35TH ST	940030	21,000	2019	3,020	1,115	C	0.379	1,074	C	0.365
VIRGINIA AVE	25TH ST to 13TH ST	940033	23,500	2019	3,020	1,229	C	0.418	1,308	C	0.445
VIRGINIA AVE	13TH ST to 11TH ST	940794	25,500	2019	3,020	1,228	C	0.418	1,228	C	0.418
VIRGINIA AVE	11TH ST to SUNRISE BLVD	940794	25,500	2019	3,170	1,228	C	0.397	1,228	C	0.397
VIRGINIA AVE	SUNRISE BLVD to OLEANDER AVE	940792	22,000	2019	3,020	1,198	C	0.407	1,118	C	0.380
VIRGINIA AVE	OLEANDER AVE to COLONIAL RD	940034	19,200	2019	3,170	1,083	C	0.350	1,059	C	0.343
VIRGINIA AVE	COLONIAL RD to US 1	940034	19,200	2019	3,020	1,083	C	0.368	1,059	C	0.360
VILLAGE PKWY	DISCOVERY WAY to TRADITION PKWY	718	14,000	2019	2,650	732	C	0.595	797	C	0.648
VILLAGE PKWY	BECKER RD to DISCOVERY WAY	718	14,000	2019	1,710	732	C	0.951	797	D	0.466
VILLAGE PKWY	TRADITION PKWY to WESTCLIFFE LN	719	23,000	2019	1,710	1,208	D	0.706	1,265	D	0.740

- * Note: A six digit number in the "STATION ID" column identifies segment counted by FDOT
- * Volumes shown were adjusted using FDOT Seasonal Factors
- * AADT = Annual Average Daily Traffic (volumes for both directions where applicable)
- * **Counts with an ID format of 6 digits have data extracted from FDOT count stations.**

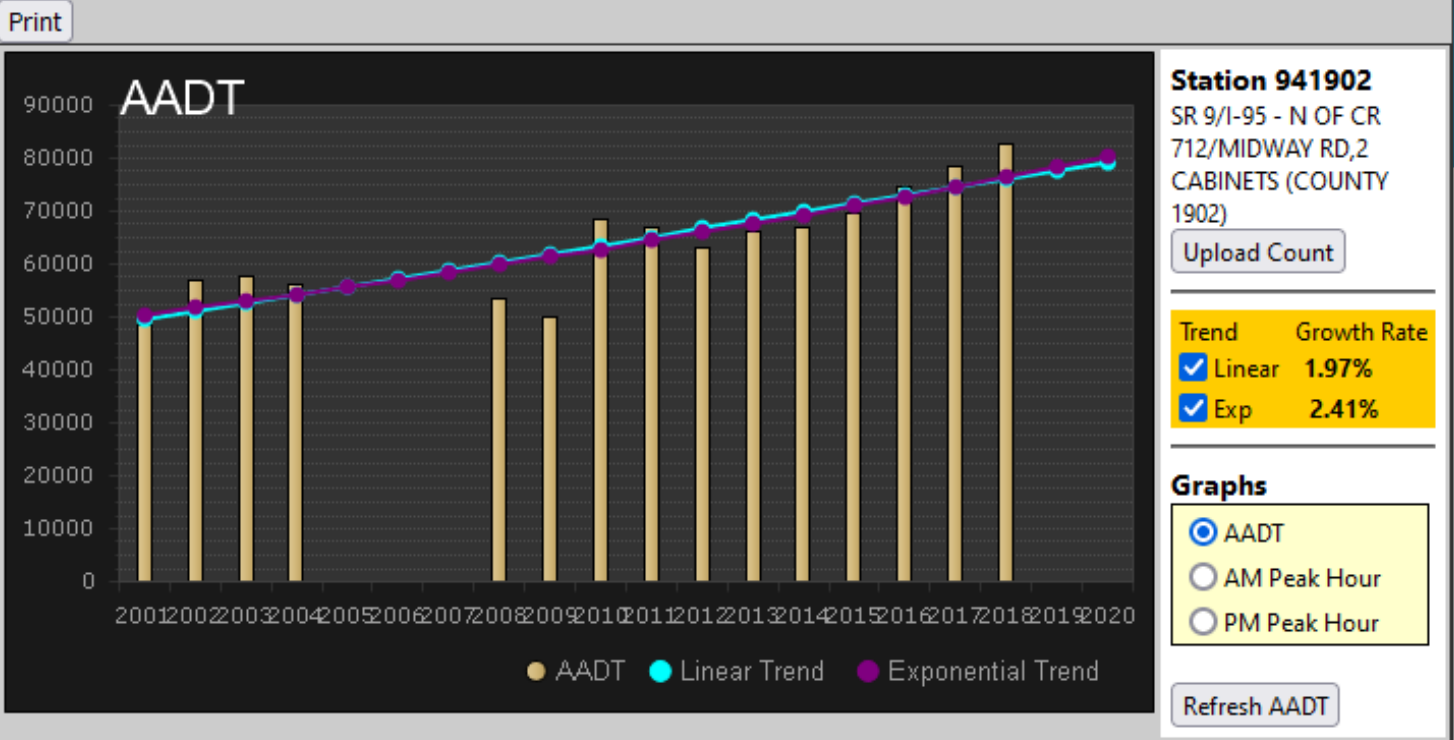

<input checked="" type="checkbox"/>	Year	Station	AADT	K100	Avg DFactor	Heavy Vehicle %	AM Peak Vol	PM Peak Vol
▼	Location: Station 941902-SR 9/I-95 - N OF CR 712/MIDWAY RD,2 CABINETS (COUNTY 1902)							
<input checked="" type="checkbox"/>	View Details	2018	941902	82500	61.9			
<input checked="" type="checkbox"/>	View Details	2017	941902	78500	61.8			
<input checked="" type="checkbox"/>	View Details	2016	941902	74500	63.1			
<input checked="" type="checkbox"/>	View Details	2015	941902	69500	62.8	8.01		
<input checked="" type="checkbox"/>	View Details	2014	941902	67000	62.5	7.51		

Print

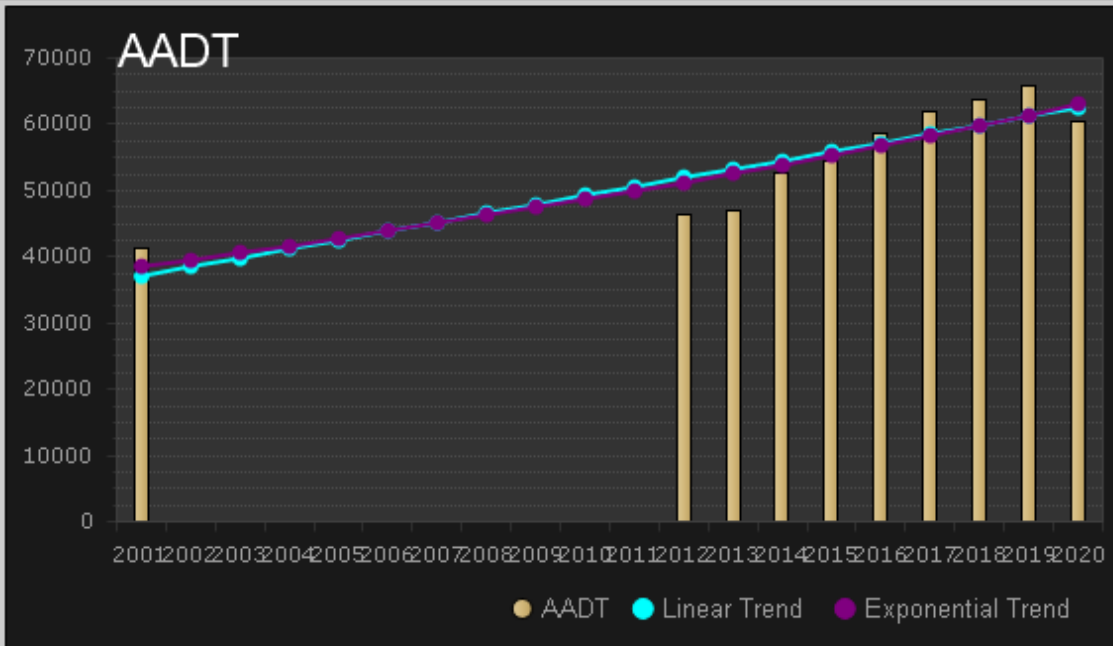

Station 940260
 SR 9/I-95-0.6 MI S OF SR 68/ORANGE AV,ST LUCIE CO

Upload Count

Trend	Growth Rate
<input checked="" type="checkbox"/> Linear	2.14%
<input checked="" type="checkbox"/> Exp	2.55%

Graphs

- AADT
- AM Peak Hour
- PM Peak Hour

Refresh AADT

<input checked="" type="checkbox"/>	Year	Station	AADT	K100	Avg DFactor	Heavy Vehicle %	AM Peak Vol	PM Peak Vol
∨	Location: Station 940260-SR 9/I-95-0.6 MI S OF SR 68/ORANGE AV,ST LUCIE CO							
<input checked="" type="checkbox"/>	View Details	2020	940260	60386	0.52	-1		
<input checked="" type="checkbox"/>	View Details	2019	940260	65918	52			
<input checked="" type="checkbox"/>	View Details	2018	940260	63766	51.8			
<input checked="" type="checkbox"/>	View Details	2017	940260	61831	52.1			
<input checked="" type="checkbox"/>	View Details	2016	940260	58614	52.4			
<input checked="" type="checkbox"/>	View	2015	940260	54502	52.6	11.09		

Print

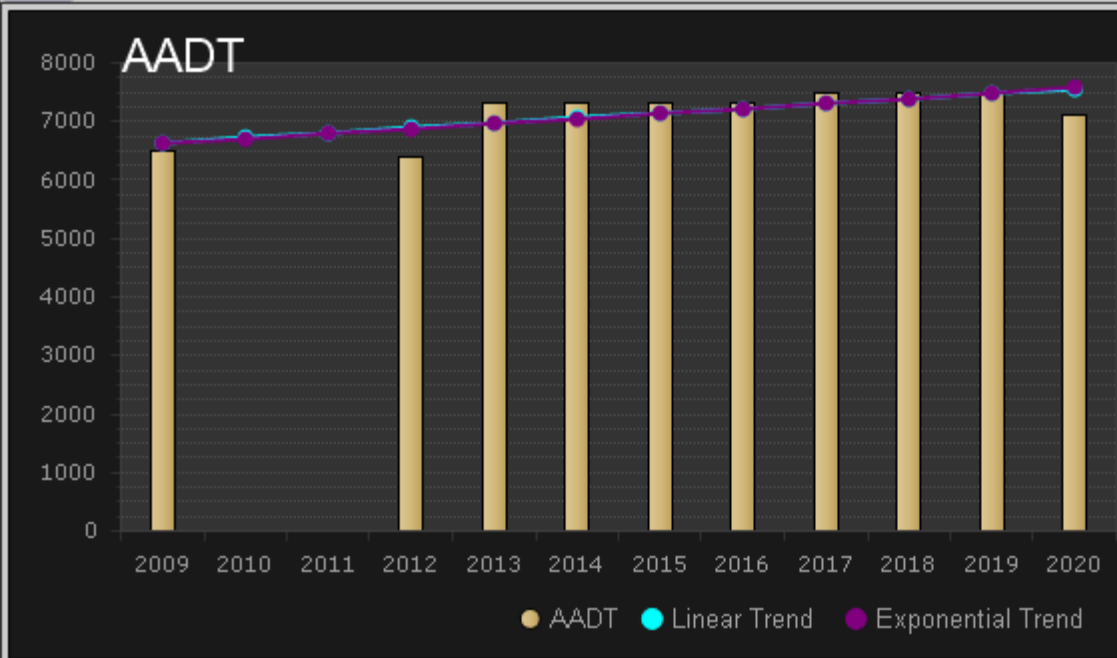

Station 947027
 ON JENKINS RD SOUTH
 - S. OF OKEECHOBEE RD
 (COUNTY 133)

Upload Count

Trend	Growth Rate
<input checked="" type="checkbox"/> Linear	1.11%
<input checked="" type="checkbox"/> Exp	1.19%

Graphs

- AADT
- AM Peak Hour
- PM Peak Hour

Refresh AADT

<input checked="" type="checkbox"/>	Year	Station	AADT	K100	Avg DFactor	Heavy Vehicle %	AM Peak Vol	PM Peak Vol
Location: Station 947027-ON JENKINS RD SOUTH - S. OF OKEECHOBEE RD (COUNTY 133)								
<input checked="" type="checkbox"/>	2020	947027	7100		0.51	-1		
<input checked="" type="checkbox"/>	2019	947027	7500		51			
<input checked="" type="checkbox"/>	2018	947027	7500		51.3			
<input checked="" type="checkbox"/>	2017	947027	7500		50.9			
<input checked="" type="checkbox"/>	2016	947027	7300		50.9			
<input checked="" type="checkbox"/>	2015	947027	7300		51			

Print

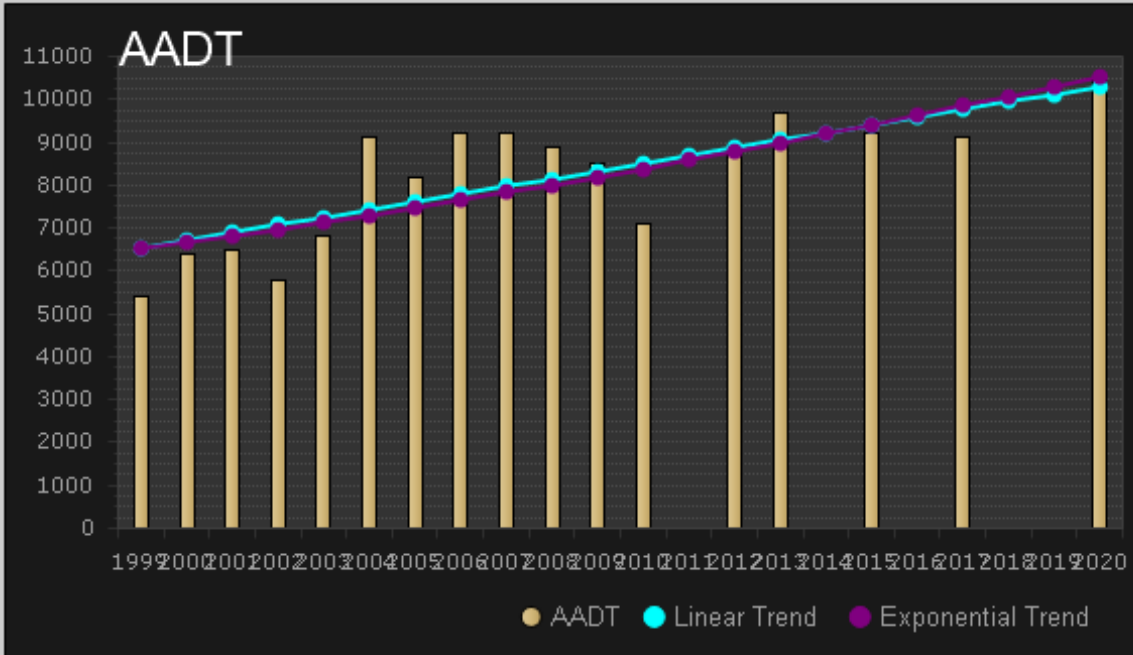

Station 131
 JENKINS RD 600 FEET
 NORTH OF
 OKEECHOBEE RD

Upload Count

Trend	Growth Rate
<input checked="" type="checkbox"/> Linear	1.75%
<input checked="" type="checkbox"/> Exp	2.27%

Graphs

- AADT
- AM Peak Hour
- PM Peak Hour

Refresh AADT

<input checked="" type="checkbox"/>	Year	Station	AAADT	K100	Avg DFactor	Heavy Vehicle %	AM Peak Vol	PM Peak Vol	
▼	Location: Station 131-JENKINS RD 600 FEET NORTH OF OKEECHOBEE RD								
<input checked="" type="checkbox"/>	View Details	2021	131	9900	0.093	0.569	0		
<input checked="" type="checkbox"/>	View Details	2020	131	10500	0.103	0.5265	0	755 918	
<input checked="" type="checkbox"/>	View Details	2017	131	9100	0.106	0.5655	0	770 886	
<input checked="" type="checkbox"/>	View Details	2015	131	9200	0.104	0.522	0	751 891	
<input checked="" type="checkbox"/>	View Details	2013	131	9700			0	727 895	
<input checked="" type="checkbox"/>	View Details	2012	131	8700	0.099	0.528	5.8	708 781	

Print

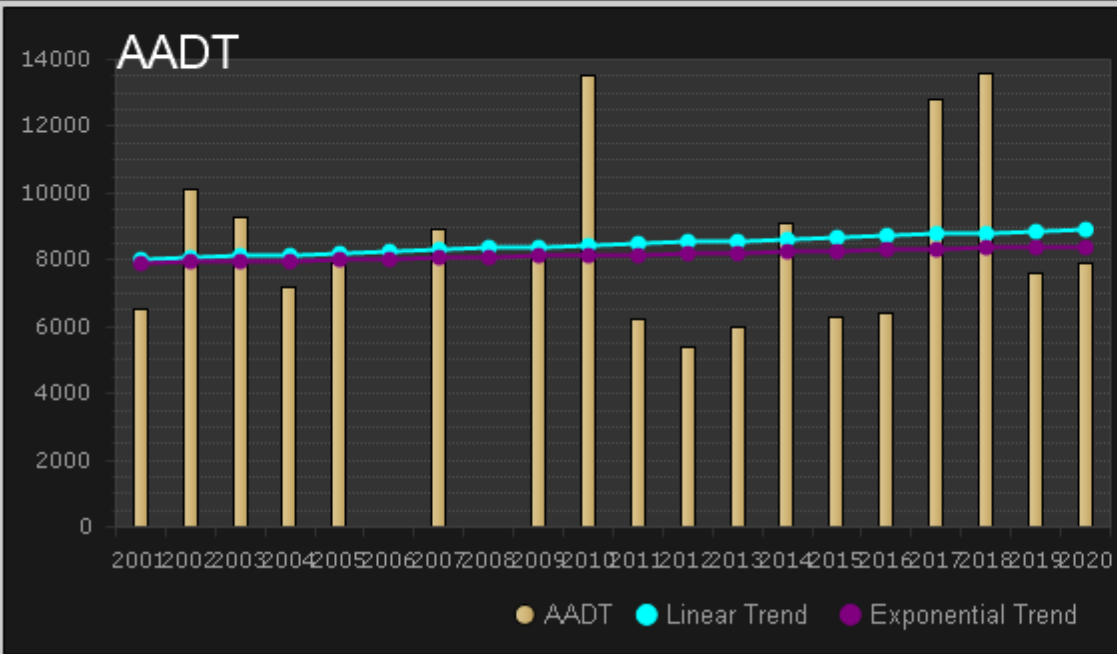

Station 940757
 SR 713 / KINGS HWY - N OF SR 70/OKEECHOBEE RD (COUNTY 757)

Upload Count

Trend	Growth Rate
<input checked="" type="checkbox"/> Linear	0.52%
<input checked="" type="checkbox"/> Exp	0.32%

Graphs

- AADT
- AM Peak Hour
- PM Peak Hour

Refresh AADT

<input checked="" type="checkbox"/>	Year	Station	AADT	K100	Avg DFactor	Heavy Vehicle %	AM Peak Vol	PM Peak Vol
-------------------------------------	------	---------	------	------	-------------	-----------------	-------------	-------------

Location: Station 940757-SR 713 / KINGS HWY - N OF SR 70/OKEECHOBEE RD (COUNTY 757)

<input checked="" type="checkbox"/>	View Details	2020	940757	7900		0.543	-1	
<input checked="" type="checkbox"/>	View Details	2019	940757	7600		54.3		
<input checked="" type="checkbox"/>	View Details	2018	940757	13600		55.2		
<input checked="" type="checkbox"/>	View Details	2017	940757	12800		56.2		
<input checked="" type="checkbox"/>	View Details	2016	940757	6400		57.1		
<input checked="" type="checkbox"/>	View	2015	940757	6300		56.3	18.77	

Count Station Summary

Count Data Detail

Print

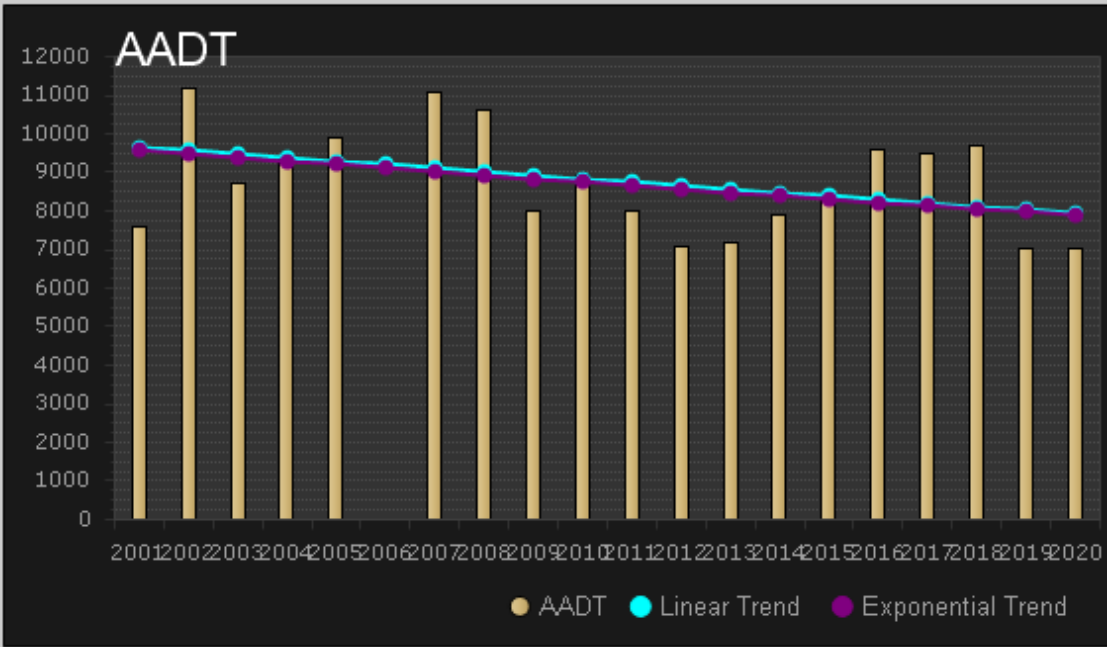

Station 940076

SR 713 / KINGS HWY - S OF SR 68/ORANGE AVE (COUNTY 76)

Upload Count

Trend	Growth Rate
<input checked="" type="checkbox"/> Linear	-1.13%
<input checked="" type="checkbox"/> Exp	-1.03%

Graphs

- AADT
- AM Peak Hour
- PM Peak Hour

Refresh AADT

<input checked="" type="checkbox"/>	Year	Station	AAADT	K100	Avg DFactor	Heavy Vehicle %	AM Peak Vol	PM Peak Vol
Location: Station 940076-SR 713 / KINGS HWY - S OF SR 68/ORANGE AVE (COUNTY 76)								
<input checked="" type="checkbox"/>	View Details	2020	940076	7000	0.543	-1		
<input checked="" type="checkbox"/>	View Details	2019	940076	7000	54.3			
<input checked="" type="checkbox"/>	View Details	2018	940076	9700	55.2			
<input checked="" type="checkbox"/>	View Details	2017	940076	9500	56.2			
<input checked="" type="checkbox"/>	View Details	2016	940076	9600	57.1			
<input checked="" type="checkbox"/>	View Details	2015	940076	8400	56.3	10.47		

Print

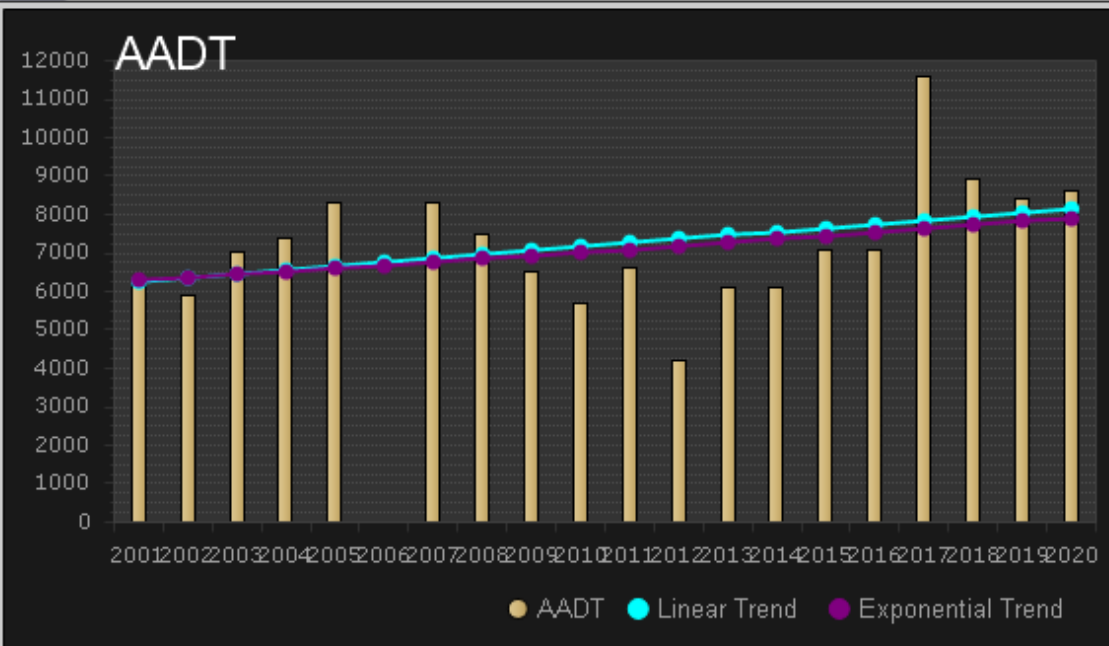

Station 940025
 SR 70/OKEECHOBEE RD
 - W OF SR 91/TPK
 (COUNTY 25)

Upload Count

Trend	Growth Rate
<input checked="" type="checkbox"/> Linear	1.21%
<input checked="" type="checkbox"/> Exp	1.21%

Graphs

- AADT
- AM Peak Hour
- PM Peak Hour

Refresh AADT

<input checked="" type="checkbox"/>	Year	Station	AADT	K100	Avg DFactor	Heavy Vehicle %	AM Peak Vol	PM Peak Vol
Location: Station 940025-SR 70/OKEECHOBEE RD - W OF SR 91/TPK (COUNTY 25)								
<input checked="" type="checkbox"/>	View Details	2020	940025	8600	0.543	-1		
<input checked="" type="checkbox"/>	View Details	2019	940025	8400	54.3			
<input checked="" type="checkbox"/>	View Details	2018	940025	8900	55.2			
<input checked="" type="checkbox"/>	View Details	2017	940025	11600	56.2			
<input checked="" type="checkbox"/>	View Details	2016	940025	7100	57.1			
<input checked="" type="checkbox"/>	View Details	2015	940025	7100	56.3	5.9		

Print

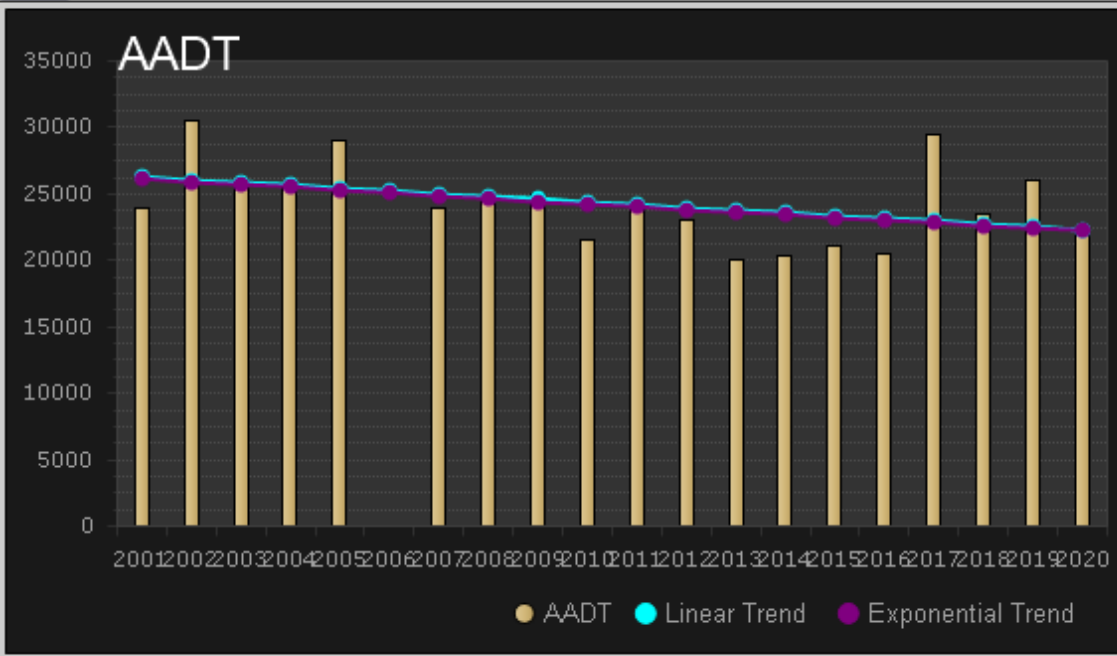

Station 940748

SR 70/OKEECHOBEE RD
- E OF SR 713/KINGS
HWY (COUNTY 742)

Upload Count

Trend	Growth Rate
<input checked="" type="checkbox"/> Linear	-0.93%
<input checked="" type="checkbox"/> Exp	-0.85%

Graphs

- AADT
- AM Peak Hour
- PM Peak Hour

Refresh AADT

<input checked="" type="checkbox"/>	Year	Station	AADT	K100	Avg DFactor	Heavy Vehicle %	AM Peak Vol	PM Peak Vol
∨	Location: Station 940748-SR 70/OKEECHOBEE RD - E OF SR 713/KINGS HWY (COUNTY 742)							
<input checked="" type="checkbox"/>	View Details	2020	940748	22500		0.543	-1	
<input checked="" type="checkbox"/>	View Details	2019	940748	26000		54.3		
<input checked="" type="checkbox"/>	View Details	2018	940748	23500		55.2		
<input checked="" type="checkbox"/>	View Details	2017	940748	29500		56.2		
<input checked="" type="checkbox"/>	View Details	2016	940748	20500		57.1		
<input checked="" type="checkbox"/>	View Details	2015	940748	21100		56.3	13.71	

Print

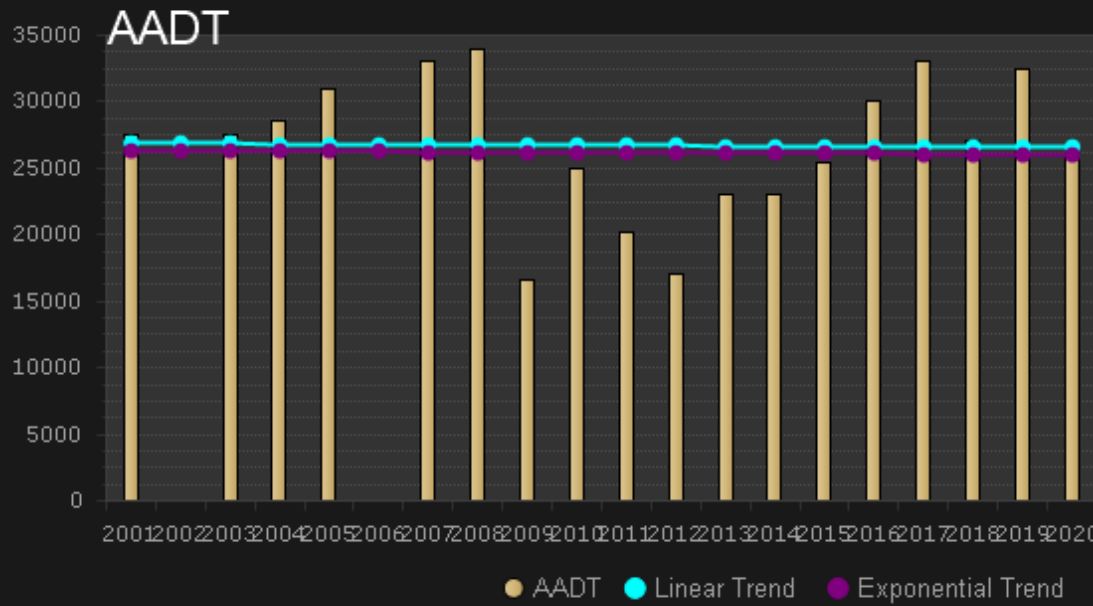

Station 940106
 SR 70/OKEECHOBEE RD
 - W OF SR 9\I-95
 (COUNTY 0106)
[Upload Count](#)

Trend	Growth Rate
<input checked="" type="checkbox"/> Linear	-0.07%
<input checked="" type="checkbox"/> Exp	-0.05%

Graphs

- AADT
- AM Peak Hour
- PM Peak Hour

[Refresh AADT](#)

<input checked="" type="checkbox"/>	Year	Station	AAADT	K100	Avg DFactor	Heavy Vehicle %	AM Peak Vol	PM Peak Vol
Location: Station 940106-SR 70/OKEECHOBEE RD - W OF SR 9\I-95 (COUNTY 0106)								
<input checked="" type="checkbox"/>	View Details	2020	940106	26500		0.543	-1	
<input checked="" type="checkbox"/>	View Details	2019	940106	32500		54.3		
<input checked="" type="checkbox"/>	View Details	2018	940106	27000		55.2		
<input checked="" type="checkbox"/>	View Details	2017	940106	33000		56.2		
<input checked="" type="checkbox"/>	View Details	2016	940106	30000		57.1		
<input checked="" type="checkbox"/>	View Details	2015	940106	25500		56.3	5.92	

Print

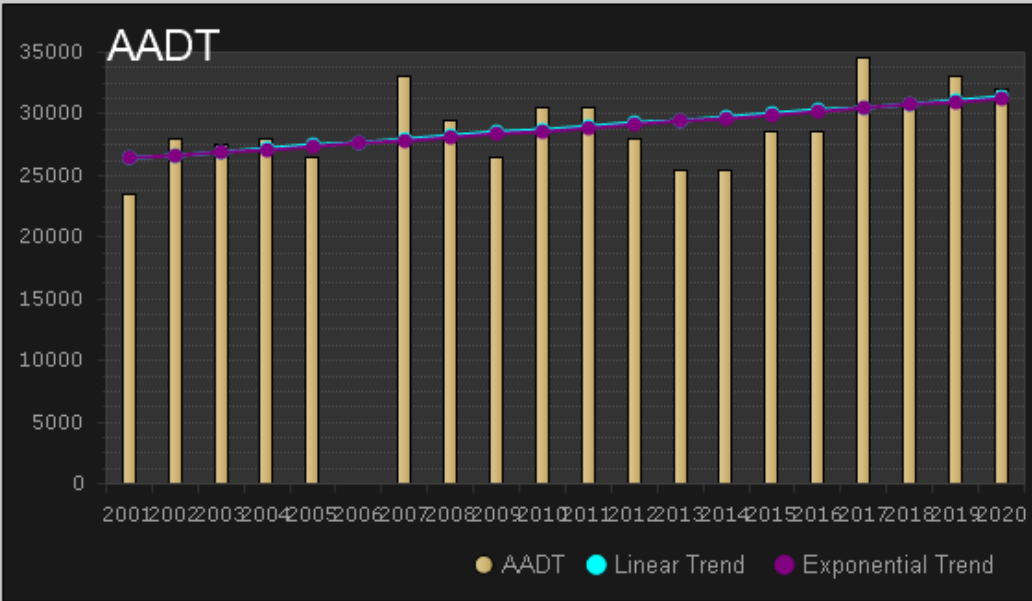

Station 940029

SR 70 / OKEECHOBEE RD
- E OF SR 9/I-95
(COUNTY 29)

Upload Count

Trend	Growth Rate
<input checked="" type="checkbox"/> Linear	0.83%
<input checked="" type="checkbox"/> Exp	0.89%

Graphs

- AADT
- AM Peak Hour
- PM Peak Hour

Refresh AADT

<input checked="" type="checkbox"/>	Year	Station	AADT	K100	Avg DFactor	Heavy Vehicle %	AM Peak Vol	PM Peak Vol
Location: Station 940029-SR 70 / OKEECHOBEE RD - E OF SR 9/I-95 (COUNTY 29)								
<input checked="" type="checkbox"/>	View Details	2020	940029	32000	0.51	-1		
<input checked="" type="checkbox"/>	View Details	2019	940029	33000	51			
<input checked="" type="checkbox"/>	View Details	2018	940029	31000	51.3			
<input checked="" type="checkbox"/>	View Details	2017	940029	34500	50.9			
<input checked="" type="checkbox"/>	View Details	2016	940029	28500	50.9			
<input checked="" type="checkbox"/>	View Details	2015	940029	28500	51	8.22		

Print

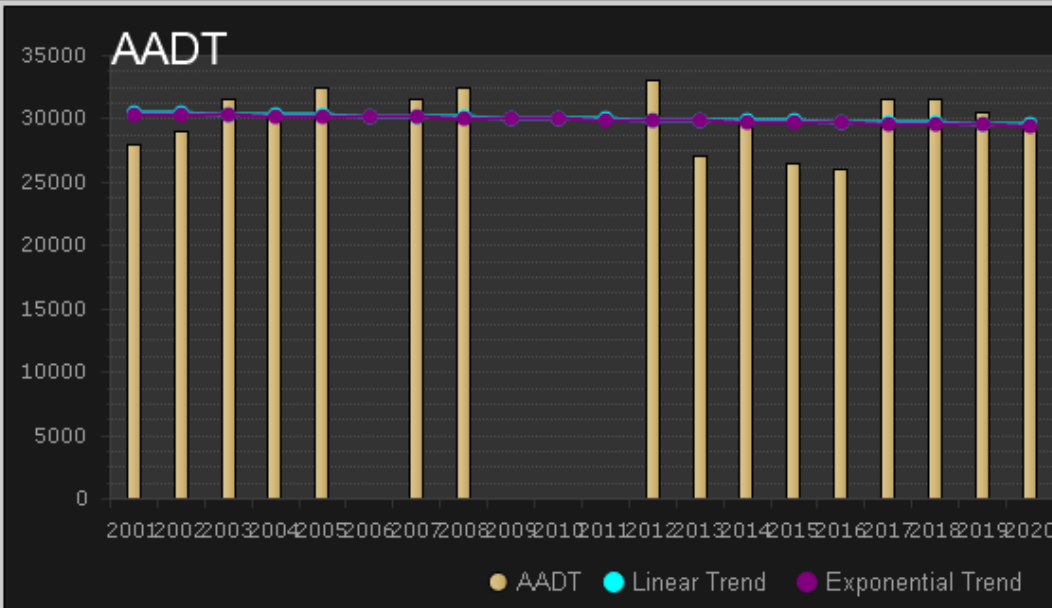

Station 940742
 SR 70/OKEECHOBEE RD
 - SW OF SR 70/VIRGINIA
 AVE (COUNTY 742)

Upload Count

Trend	Growth Rate
<input checked="" type="checkbox"/> Linear	-0.16%
<input checked="" type="checkbox"/> Exp	-0.16%

- Graphs**
- AADT
 - AM Peak Hour
 - PM Peak Hour

Refresh AADT

<input checked="" type="checkbox"/>	Year	Station	AADT	K100	Avg DFactor	Heavy Vehicle %	AM Peak Vol	PM Peak Vol
▼	Location: Station 940742-SR 70/OKEECHOBEE RD - SW OF SR 70/VIRGINIA AVE (COUNTY 742)							
<input checked="" type="checkbox"/>	View Details	2020	940742	29500	0.51	-1		
<input checked="" type="checkbox"/>	View Details	2019	940742	30500	51			
<input checked="" type="checkbox"/>	View Details	2018	940742	31500	51.3			
<input checked="" type="checkbox"/>	View Details	2017	940742	31500	50.9			
<input checked="" type="checkbox"/>	View Details	2016	940742	26000	50.9			
<input checked="" type="checkbox"/>	View Details	2015	940742	26500	51	7.3		

Print

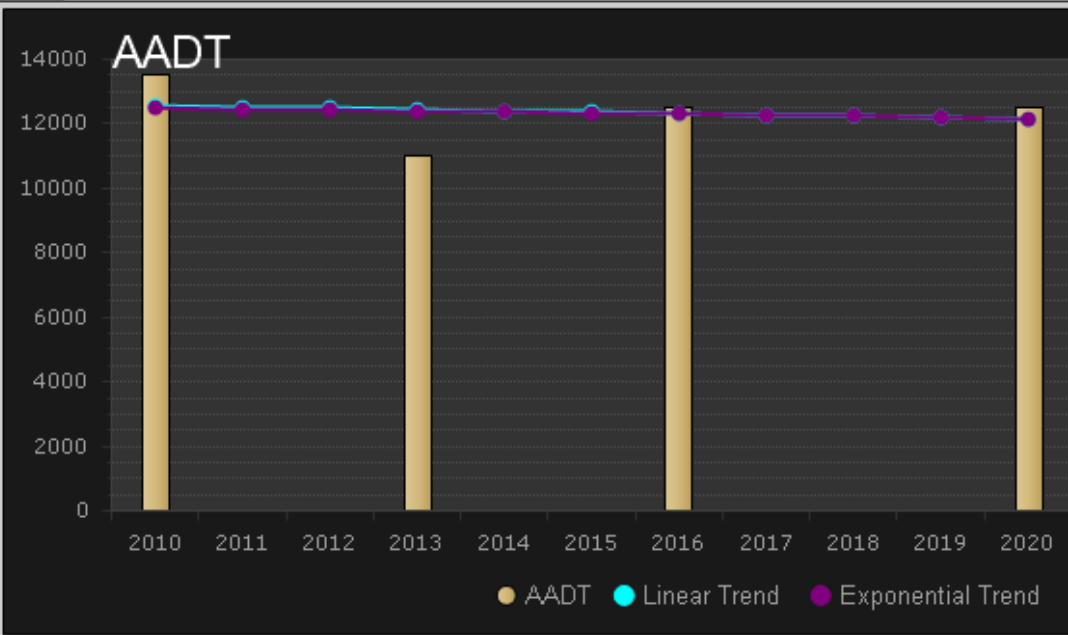

Station 688
 OKEECHOBEE RD NE. OF VIRGINIA AVE
[Upload Count](#)

Trend	Growth Rate
<input checked="" type="checkbox"/> Linear	-0.32%
<input checked="" type="checkbox"/> Exp	-0.26%

- Graphs**
- AADT
 - AM Peak Hour
 - PM Peak Hour

[Refresh AADT](#)

<input checked="" type="checkbox"/>	Year	Station	AADT	K100	Avg DFactor	Heavy Vehicle %	AM Peak Vol	PM Peak Vol	
Location: Station 688-OKEECHOBEE RD NE. OF VIRGINIA AVE									
<input checked="" type="checkbox"/>	View Details	2020	688	12500	0.105	0.5545	0	855	1121
<input checked="" type="checkbox"/>	View Details	2016	688	12500	0.107	0.5135	0	950	1249
<input checked="" type="checkbox"/>	View Details	2013	688	11000			0	840	1046
<input checked="" type="checkbox"/>	View Details	2010	688	13500	0.096	0.558	0	1016	1167

Print

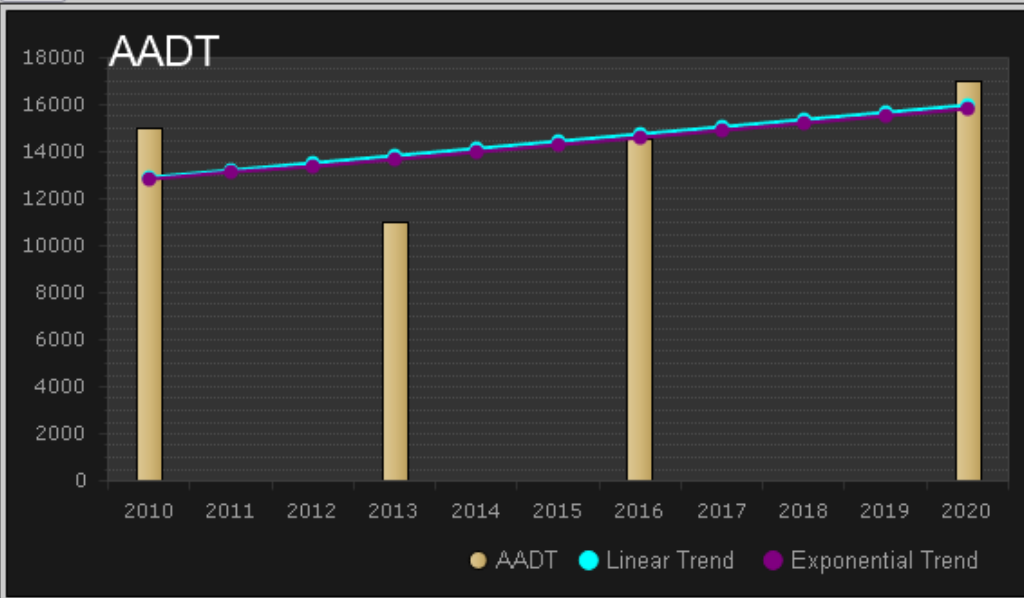

Station 689
OKEECHOBEE RD W. OF 33RD ST

Upload Count

Trend	Growth Rate
<input checked="" type="checkbox"/> Linear	1.93%
<input checked="" type="checkbox"/> Exp	2.09%

- Graphs**
- AADT
 - AM Peak Hour
 - PM Peak Hour

Refresh AADT

<input checked="" type="checkbox"/>	Year	Station	AADT	K100	Avg DFactor	Heavy Vehicle %	AM Peak Vol	PM Peak Vol	
Location: Station 689-OKEECHOBEE RD W. OF 33RD ST									
<input checked="" type="checkbox"/>	View Details	2020	689	17000	0.103	0.5155	0	1119	1468
<input checked="" type="checkbox"/>	View Details	2016	689	14500	0.109	0.51	0	1119	1463
<input checked="" type="checkbox"/>	View Details	2013	689	11000			0	911	1083
<input checked="" type="checkbox"/>	View Details	2010	689	15000	0.096	0.546	0	1179	1295

Print

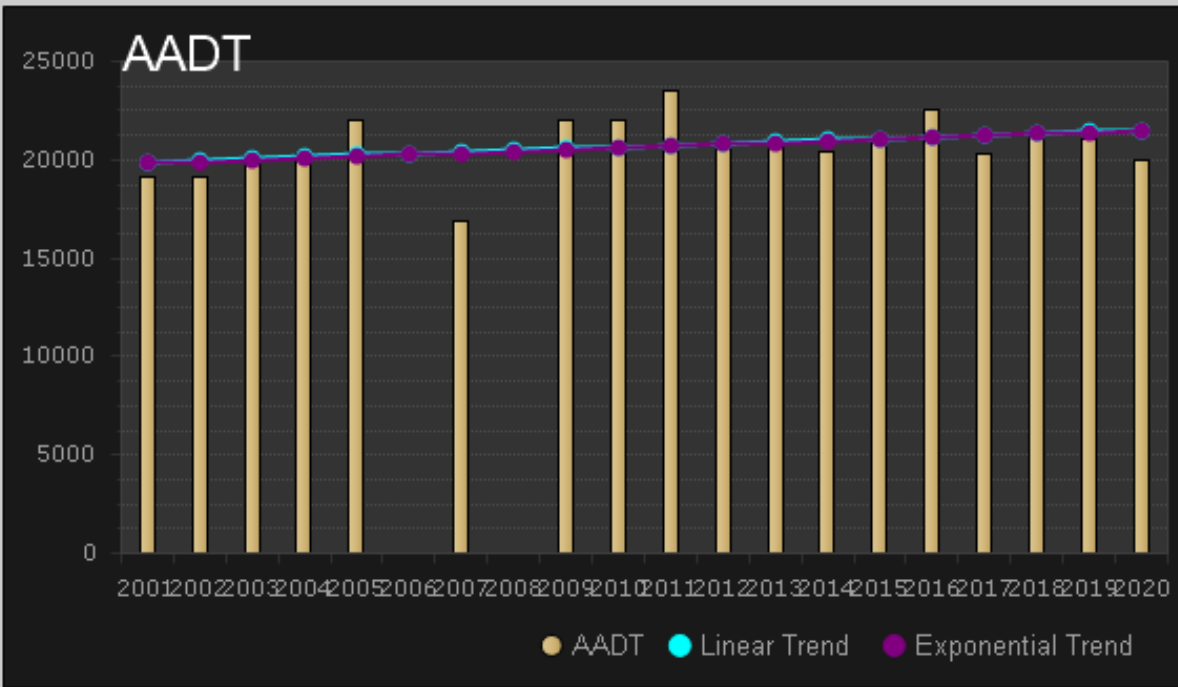

Station 940030
 SR 70 / VIRGINIA AVE - E
 OF OKEECHOBEE RD
 (COUNTY 30)

Upload Count

Trend	Growth Rate
<input checked="" type="checkbox"/> Linear	0.40%
<input checked="" type="checkbox"/> Exp	0.42%

Graphs

- AADT
- AM Peak Hour
- PM Peak Hour

Refresh AADT

<input checked="" type="checkbox"/>	Year	Station	AADT	K100	Avg DFactor	Heavy Vehicle %	AM Peak Vol	PM Peak Vol
Location: Station 940030-SR 70 / VIRGINIA AVE - E OF OKEECHOBEE RD (COUNTY 30)								
<input checked="" type="checkbox"/>	View Details	2020	940030	20000	0.51	-1		
<input checked="" type="checkbox"/>	View Details	2019	940030	21000	51			
<input checked="" type="checkbox"/>	View Details	2018	940030	21500	51.3			
<input checked="" type="checkbox"/>	View Details	2017	940030	20300	50.9			
<input checked="" type="checkbox"/>	View Details	2016	940030	22500	50.9			
<input checked="" type="checkbox"/>	View Details	2015	940030	21000	51	1.06		



**Fort Pierce
Jenkins Road
Fort Pierce, Florida**

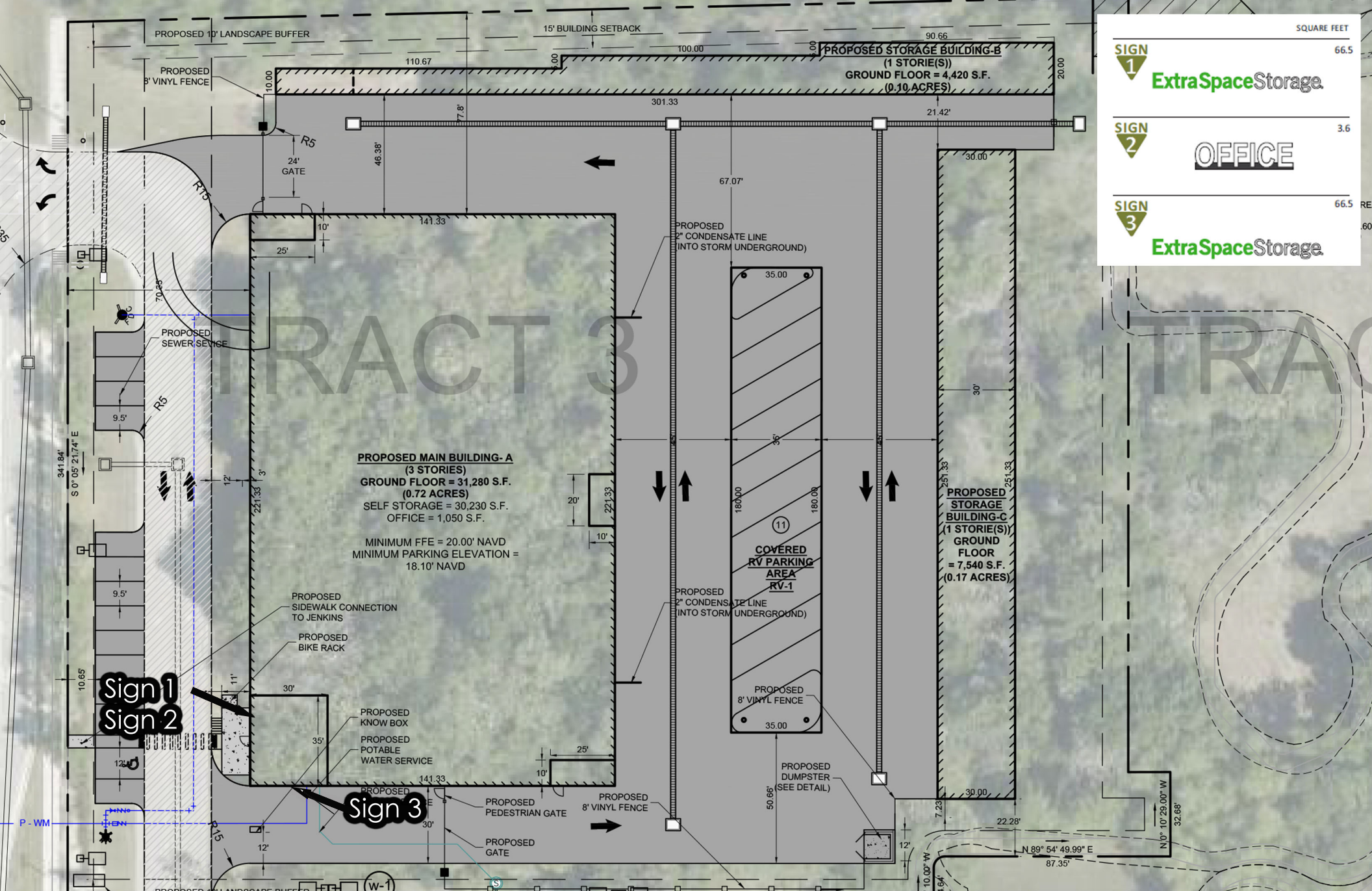

SIGN	AREA	SQUARE FEET
SIGN 1	ExtraSpaceStorage	66.5
SIGN 2	OFFICE	3.6
SIGN 3	ExtraSpaceStorage	66.5

Flagship Jenkins & Okeechobee

Signage Exhibit

Fort Pierce, FL



NORTH



ENGINEERS SURVEYORS ENVIRONMENTAL

ELEVATION

SIGN 1

SCOPE OF WORK:
 Manufacture and install 1 set of Standard 30" channel letters on raceway Green / White faces
 Placement centered on west elevation left side over windows. Raceway color TBD

SIGN 2

SCOPE OF WORK:
 Manufacture and install 1 set of Standard "Office" Channel letters on raceway White faces
 Placement West elevation bottom floor left end over door on awning

SQUARE FEET CALCULATIONS

Allowable	Existing	Proposed
NA	0	66.5

**ExtraSpace
Storage.**

SQUARE FEET CALCULATIONS

Allowable	Existing	Proposed
NA	0	3.6

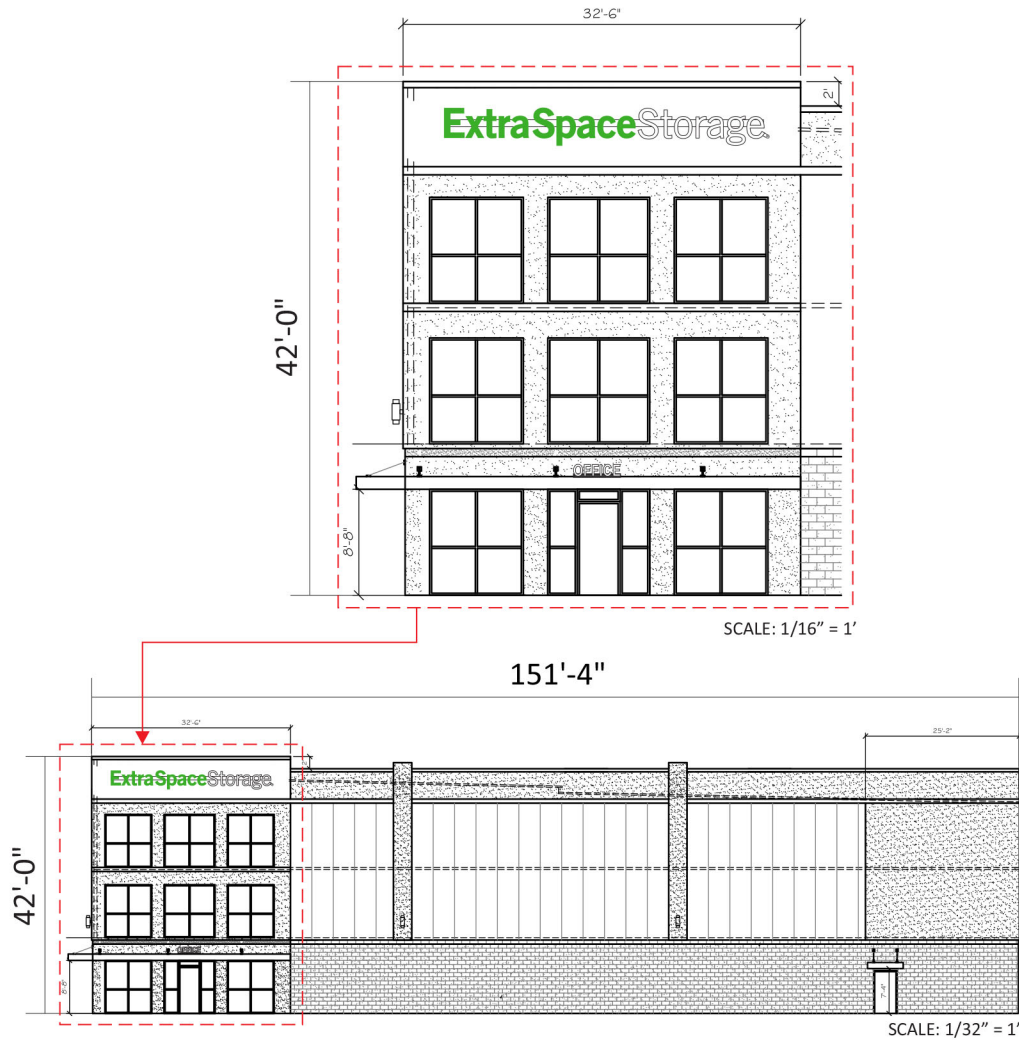

RACEWAY MOUNT CHANNEL LETTERS

SIGN
1

A B SQUARE FEET



2'-6" 26'-7 1/2" 66.5

ExtraSpace Storage.



SPECIFICATION

- 1 NON-CORROSIVE INSTALLATION HARDWARE: GALVANIZED
- 2 5" FABRICATED ALUMINUM LETTER RETURNS SEE MFG. NOTE FOR GAUGE. GLOSS BLACK PAINT INTERIOR WITH LIGHT ENHANCING PAINT
- 3 TRIM CAP RETAINER DOVE GRAY
- 4 FLAT ALUMINUM BACK
- 5 1/4" THICK METAL FLAT BAR FOR A SECURE INSTALLATION
- 6 USLED DIODE MODULE WHITE
- 7 3/16" #7328 ACRYLIC FACE WHITE WITH 1ST SURFACE TRANSLUCENT VINYL AS SHOWN
- 8 LOW VOLTAGE ELECTRONIC POWER SUPPLY MOUNTED IN A 7 1/4" X 7 1/4" EXTRUDED .050 ALUM. RACEWAY SUPPORT/WIRING BOX PAINTED TO BE DETERMINED
- 9 VISIBLE CUT-OFF SWITCH WITH FLIP-UP COVER
- 10 1/8" WEEP HOLES (2) TWO PER LETTER
- 11 GROUNDED WALL PASS-THRU SEALED WATER TIGHT. WHIP ON LEFT SIDE.

SECTION DETAIL

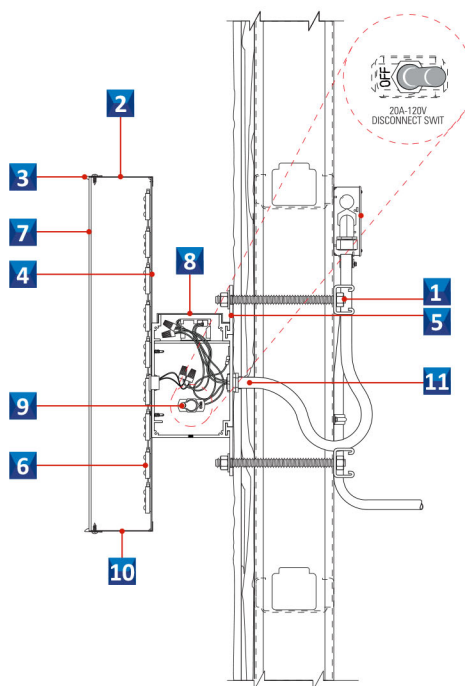

MOUNTING DETAILS

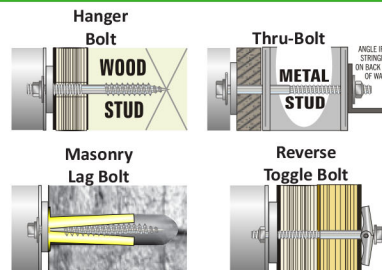

*All Hardware to be Galvanized and Non Corrosive

COLOR SCHEDULE

- GREEN** #2500-106 BRILLIANT
- GREY** DOVE GRAY TRIMCAP
- BLACK** PMS BLACK #2500-022
- WHITE**

ELECTRICAL REQUIREMENT

L.E.D.	"USLED" WHITE L.E.D. MODULES
POWER SUPPLY	24V "ADVANCE" POWER SUPPLY
AMPS	0.79A
CIRCUITS	(1) 20A-120V
DISCONNECT	(1) 20A-120V

MANUFACTURING NOTES

- CHANNEL LETTER SETS SMALLER THAN 48" WILL BE CONSTRUCTED USING .040 ALUMINUM RETURNS & .063 ALUMINUM BACKS
- CHANNEL LETTER SETS 48"-71" WILL BE CONSTRUCTED USING .063 ALUMINUM RETURNS & .090 ALUMINUM BACKS
- REGISTRATION MARK TO BE BLACK VINYL ON ALUMINUM TAB ATTACHED TO BACK OF "e" CHANNEL LETTER.

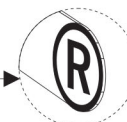

BRACING DETAIL

WHEN NEEDED SUPPORTS TO BE .090" ALUMINUM PAINTED TO MATCH RW POP-RIVITED TO RETURN (FACING UP TO HIDE FROM SIGHT)



CANOPY OFFICE SIGN

SIGN
2

SCALE: 1" = 1'-0"

3.6 SQ/FT

ExtraSpace
Storage.

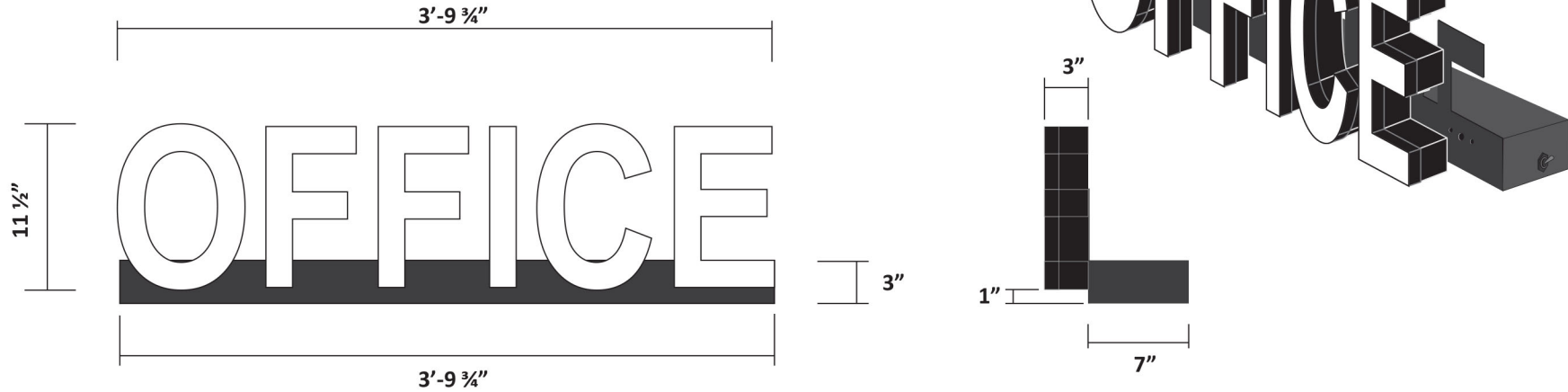

SPECIFICATIONS

- 1** NON-CORROSIVE #10 1/4" PITCH SCREW GALVANIZED
- 2** 3" FABRICATED ALUMINUM LETTER RETURNS SEE MFG. NOTE FOR GAGE. GLOSS BLACK PAINT INTERIOR WITH LIGHT ENHANCING PAINT
- 3** TRIM CAP RETAINER
- 4** FLAT ALUMINUM BACK MOUNTED TO 1/2 HEIGHT ALUMINUM PLATE ATTACHED BY NON-CORROSIVE #10 1/4" PITCH SCREW - GALVANIZED
- 5** USLED DIODE MODULE WHITE
- 6** 3/16" #2447 ACRYLIC FACE
- 7** LOW VOLTAGE ELECTRONIC POWER SUPPLY MOUNTED IN A 0.063" ALUM. RACEWAY SUPPORT / WIRING BOX (3" X 7" X 45 3/4") PAINTED SW7069 - IRON ORE
- 8** VISIBLE DISCONNECT SWITCH
- 9** DEDICATED ELECTRICAL IN FLEX CONDUIT SEALED WATER TIGHT AT WALL PENETRATIONS.

SECTION

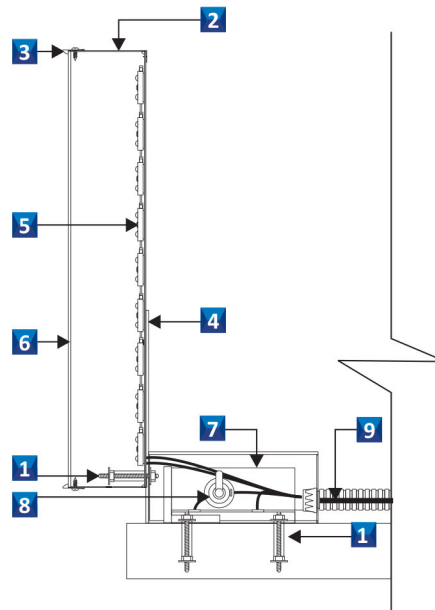

COLOR SCHEDULE

IRON ORE	#7069 IRON ORE
BLACK	PMS BLACK
WHITE	

ELEVATION

SIGN
3

SCOPE OF WORK:

Manufacture and install 1 set of Standard 30" channel letters on raceway Green / White faces
Placement centered on north elevation right side over windows. Raceway color TBD

SQUARE FEET CALCULATIONS

Allowable	Existing	Proposed
NA	0	66.5

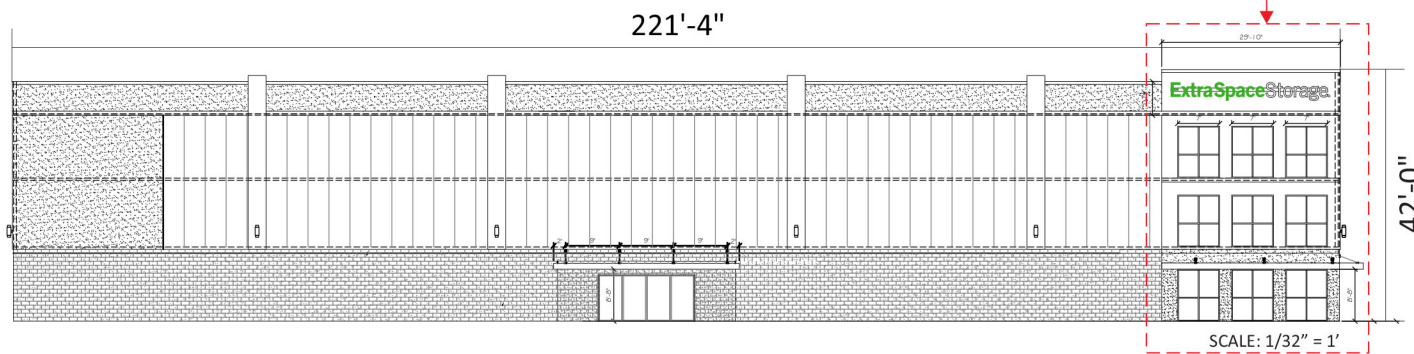
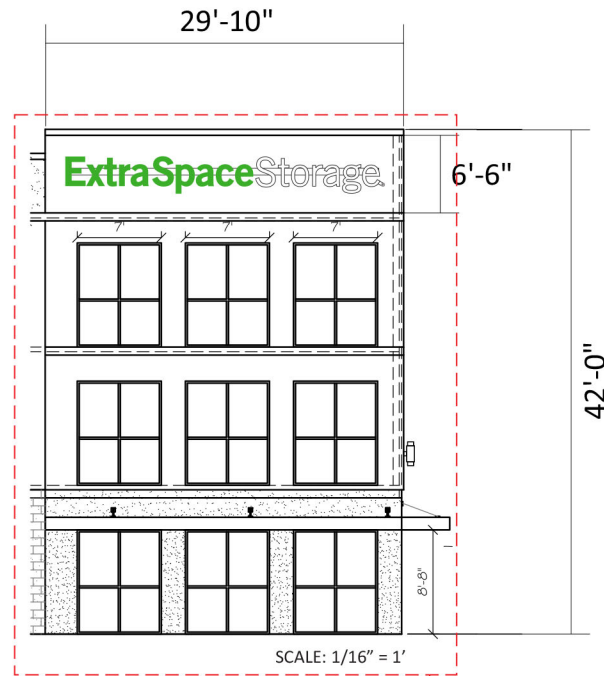

RACEWAY MOUNT CHANNEL LETTERS

SIGN
3

A B SQUARE FEET



2'-6" 26'-7 1/2" 66.5

ExtraSpace Storage.



SPECIFICATION

- 1 NON-CORROSIVE INSTALLATION HARDWARE: GALVANIZED
- 2 5" FABRICATED ALUMINUM LETTER RETURNS SEE MFG. NOTE FOR GAUGE. GLOSS BLACK PAINT INTERIOR WITH LIGHT ENHANCING PAINT
- 3 TRIM CAP RETAINER DOVE GRAY
- 4 FLAT ALUMINUM BACK
- 5 1/4" THICK METAL FLAT BAR FOR A SECURE INSTALLATION
- 6 USLED DIODE MODULE WHITE
- 7 3/16" #7328 ACRYLIC FACE WHITE WITH 1ST SURFACE TRANSLUCENT VINYL AS SHOWN
- 8 LOW VOLTAGE ELECTRONIC POWER SUPPLY MOUNTED IN A 7 1/4" X 7 1/4" EXTRUDED .050 ALUM. RACEWAY SUPPORT/WIRING BOX PAINTED **TO BE DETERMINED**
- 9 VISIBLE CUT-OFF SWITCH WITH FLIP-UP COVER
- 10 1/8" WEEP HOLES (2) TWO PER LETTER
- 11 GROUNDED WALL PASS-THRU SEALED WATER TIGHT. WHIP ON LEFT SIDE.

SECTION DETAIL

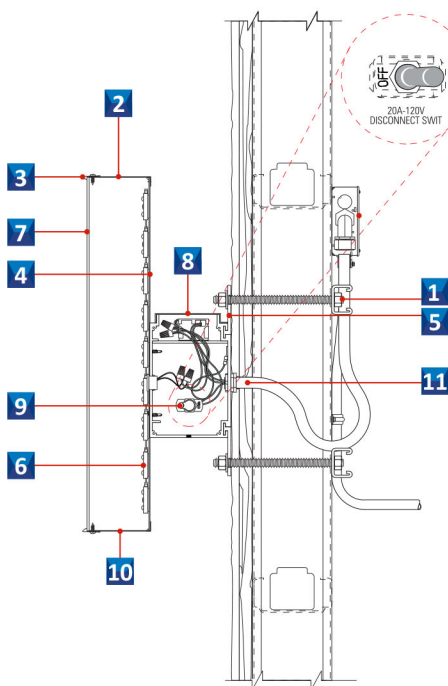

MOUNTING DETAILS

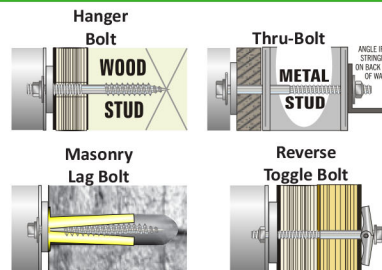

*All Hardware to be Galvanized and Non Corrosive

COLOR SCHEDULE

GREEN	#2500-106 BRILLIANT
GREY	DOVE GRAY TRIMCAP
BLACK	PMS BLACK #2500-022
WHITE	

ELECTRICAL REQUIREMENT

L.E.D.	"USLED" WHITE L.E.D. MODULES
POWER SUPPLY	24V "ADVANCE" POWER SUPPLY
AMPS	0.79A
CIRCUITS	(1) 20A-120V
DISCONNECT	(1) 20A-120V

MANUFACTURING NOTES

CHANNEL LETTER SETS SMALLER THAN 48" WILL BE CONSTRUCTED USING .040 ALUMINUM RETURNS & .063 ALUMINUM BACKS

CHANNEL LETTER SETS 48"-71" WILL BE CONSTRUCTED USING .063 ALUMINUM RETURNS & .090 ALUMINUM BACKS

REGISTRATION MARK TO BE BLACK VINYL ON ALUMINUM TAB ATTACHED TO BACK OF "e" CHANNEL LETTER.

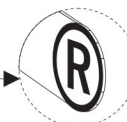

BRACING DETAIL

WHEN NEEDED SUPPORTS TO BE .090" ALUMINUM PAINTED TO MATCH RW POP-RIVITED TO RETURN (FACING UP TO HIDE FROM SIGHT)



April 23, 2021

Flagship Companies Group, LLC
Attn: Phillip C. Hollis, MS/PE
1190 Business Center Drive, Ste. 2000
Lake Mary, FL 32746

VIA Email:

Reference: **Environmental Assessment**
Jenkins Road
Fort Pierce, FL 34982
Parcel ID # 2419-603-0003-000-4; 2419-603-0004-000-1

Dear Mr. Hollis,

EDC, Inc. (EDC) has completed this Environmental Assessment (EA) for the above referenced parcels. The purpose of this evaluation was to conduct a review of the above listed parcels by means of site visit, review of available aerial photography, listed species review, review of soil resources, and review of environmental regulations pertaining to this parcel.

The following report details the findings of our on-site and desktop investigations of the properties as they pertain to City of Fort Pierce developmental review regulations.

Please contact the undersigned if you have any questions regarding this report.

Respectfully submitted,
EDC, Inc.



Anthony A. Adams, BS
Sr. Biologist | Certified Arborist



ENGINEERS • SURVEYORS • ENVIRONMENTAL

ENVIRONMENTAL ASSESSMENT

Parcel IDs: 2419-603-0003-000-4; 2419-603-0004-000-1
Jenkins Road
Fort Pierce, FL 34947

Date: April 23, 2021
Project # 21-241

Prepared For:
Phillip C. Hollis, MS/PE
1190 Business Center Drive, Ste. 2000
Lake Mary, FL 32746

Prepared By:
EDC, Inc.
10250 SW Village Parkway
Port St Lucie, Florida 34987
(772) 223-5200

The subject property evaluated as part of this Environmental Assessment consists of one tax parcel (Parcel ID #2419-603-0003-000-4; 2419-603-0004-000-1) comprised of 4.73 acres combined. The property is classified by the St. Lucie County Property Appraiser with a Future Land Use Designation of General Commercial. The parcels are located just east of Jenkins Road, north of Okeechobee Road, in St. Lucie County, Florida. The subject property is further located within Section 19, Township 35 South, and Range 40 East, St. Lucie County, Florida.

This environmental assessment was completed as a precursor to permitting and review by governmental agencies as an applicable document for the supporting information associated with a building permit or land development application. EDC, Inc. staff visited the property on April 23, 2021 in order to ascertain the status and composition of any critical habitats, such as wetlands and native uplands that may be onsite.

VEGETATION:

It is the opinion of EDC that there is no native upland habitat located on site. The upland habitat consisted of the following FLUCCS (Florida Land Use & Cover Classification System) code; 422 – Brazilian Pepper/Exotic Hardwoods, approx. 3.51 acres. The remaining acreage of the subject parcel is considered non-native and consisted of 211 – improved pastures and 424 – Melaleuca. Both the improved pasture habitat and the hardwoods are heavily invaded with exotic vegetation. It is important to note that there is native vegetation present, but the native vegetation does not have significant associations greater than 50% and is therefore not considered to be native habitat.

Common Name	Species Name
Cabbage Palm	<i>Sabal Palmetto</i>
Laurel Oak	<i>Quercus laurifolia</i>
Live Oak	<i>Quercus virginiana</i>
Saw Palmetto	<i>Serenoa repens</i>
Slash Pine	<i>Pinus elliottii var. densa</i>
Broom Grass	<i>Andropogon spp.</i>
Brazilian Pepper**	<i>Schinus terebinthifolia</i>
Melaleuca	<i>Melaleuca quinquenervia</i>
Lead Tree**	<i>Leucaena leucocephala</i>
Rosary Pea**	<i>Abrus precatorius</i>
Earleaf Acacia**	<i>Acacia auriculiformis</i>
Caesarweed**	<i>Urena lobata</i>
Cogongrass**	<i>Imperata cylindrica</i>
Guinea grass**	<i>Megathrysus maximus</i>

*Nuisance Vegetation
 **Exotic/Invasive Vegetation

Table 1: This table lists a representative sample of upland vegetative species observed during the site visit.

WETLAND DELINEATION:

According to aerial photographs and site visit, it appears that there are no State jurisdictional wetlands on site. Based on the State definition, a wetland consists of three components: 1) hydric soils, 2) wetland plants, and 3) hydrologic indicators. These components were not found during the field reconnaissance on the property.

WILDLIFE EVALUATION:

EDC, Inc. conducted a pedestrian survey throughout the property to investigate for the presence of any plant or animal listed species. No gopher tortoises, their burrows or habitat were observed on site. In addition, no sandhill cranes or their nests were identified on site.

Due to anthropogenic disturbances onsite such as, periodically cleared areas, many listed species may not be found onsite due to the lack of suitable foraging and nesting habitat. No other state or federally listed plant/animal species were found on site.

SOIL COMPOSITION:

Based on a review of the USDA Web Soil the site is composed of:

Nettles Sand - is a poorly drained, nearly level soil found in areas of broad flatwoods. Typically, the surface layer is 11 inches thick. Black sand comprises the upper 5 inches, very dark gray sand in the next three inches and dark gray sand in the lower 3 inches. Subsurface layer is light gray sand 22 inches thick. The water table is typically at a depth of 10 inches for 2 to 4 months during wet seasons, and at a depth of 10 to 40 inches for 6 months or longer in most years. Natural vegetation includes slash pine, cabbage palm, saw palmetto, wax myrtle, inkberry, fetterbush, creeping bluestem, chalky bluestem, Florida threeawn, and pineland threeawn. This soil has severe limitations for cultivated crops unless water control and other food management practices are provided. This soil has potential for improved pasture grasses and high potential for dwellings without basements, small commercial buildings, and roads.

Oldsmar fine sand- This poorly drained soil is found typically in broad areas in the flatwoods. Typically, the surface layer is black fine sand about 5 inches thick. The water table is at a depth of less than 10 inches for 2 to 4 months during the wet season and within a depth of 40 inches for more than 6 months. Natural vegetation consists of slash pine, saw palmetto, inkberry, rusty lyonia, black root, penny royal, pineland threeawn, chalky bluestem, panicum and various grasses. The soil is well suited for pasture and hay crops.

SITE HISTORY:

After reviewing available aerial images on Google Earth, and the St. Lucie County Property Appraiser, the property was semi-developed as far back as 1992. At that time a residence can be observed, along with signs of light agricultural use. After this image, it is observed that the land is no longer the subject of agricultural activity, as there is a noticeable increase in vegetation size and density. By 2005, it is apparent that this land is vacant, and receiving no management of any kind. All trails that were previously distinguishable in aerial images are unable to be seen after this point in time.

According to the St. Lucie County Property Appraiser, the most recent sale of these parcel occurred in May 2006.

CITY OF FORT PIERCE REGULATIONS:

The following lists the City of Fort Pierce Land Development Code that apply to the subject property. As part of the local approval process, the applicant will be required to comply with the below items.

Sec. 123-66. - Tree protection and mitigation.

(d) Mitigation shall be required for the loss of any native tree at least 14 inches DBH (except for palms which shall have a minimum clear trunk of ten feet) and shall include the following:

(1) The replacement trees, either preserved, relocated or newly planted, shall be of the same or other native species as the tree approved for removal;

(2) The quality and replacement of the replacement trees shall exceed the minimum landscape requirements otherwise set out in this article and shall be at least 12 feet tall and 2½ inches DBH except for palms which shall have a minimum clear trunk of ten feet. Any tree which is the subject of a mitigation plan shall be replaced at a ratio of one inch DBH for each inch of DBH removed, except that each palm tree which is preserved through on-site protection or relocation will count towards any required palm tree mitigation requirement at a rate of one palm tree preserved/relocated equal to one palm tree removed. The following mitigation credit shall apply:

a. Trees preserved or relocated on-site, which exceed the minimum landscape requirements of this article shall count as equivalent replacement DBH;

b. Trees planted on-site which exceed the minimum landscape code shall count as half credit towards the mitigation requirements.

This section of the City of Fort Pierce Land Development Ordinances sets forth mitigation methods and requirements in addition to the option of paying pursuant to the City of Fort Pierce Fee Schedule.

SUMMARY:

It is the professional opinion of EDC that there is no native upland habitat located on site. The site consists of 4.73 acres designated as General Commercial. The largest FLUCCS code designation is 422 - Exotic Hardwoods/Brazilian Pepper.

It is our professional opinion that there are no wetlands located on site.

No gopher tortoises, burrows, or habitat were observed on site. In addition, no sandhill cranes or their nests were identified on site. Furthermore, no other state-listed species were observed.



Environmental Assessment

Jenkins Road
Fort Pierce, St. Lucie County, FL

Location Map

Project: 21-241

Flagship Companies

04/23/2021

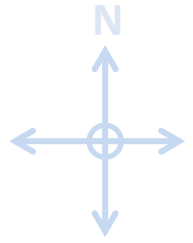

Project Location

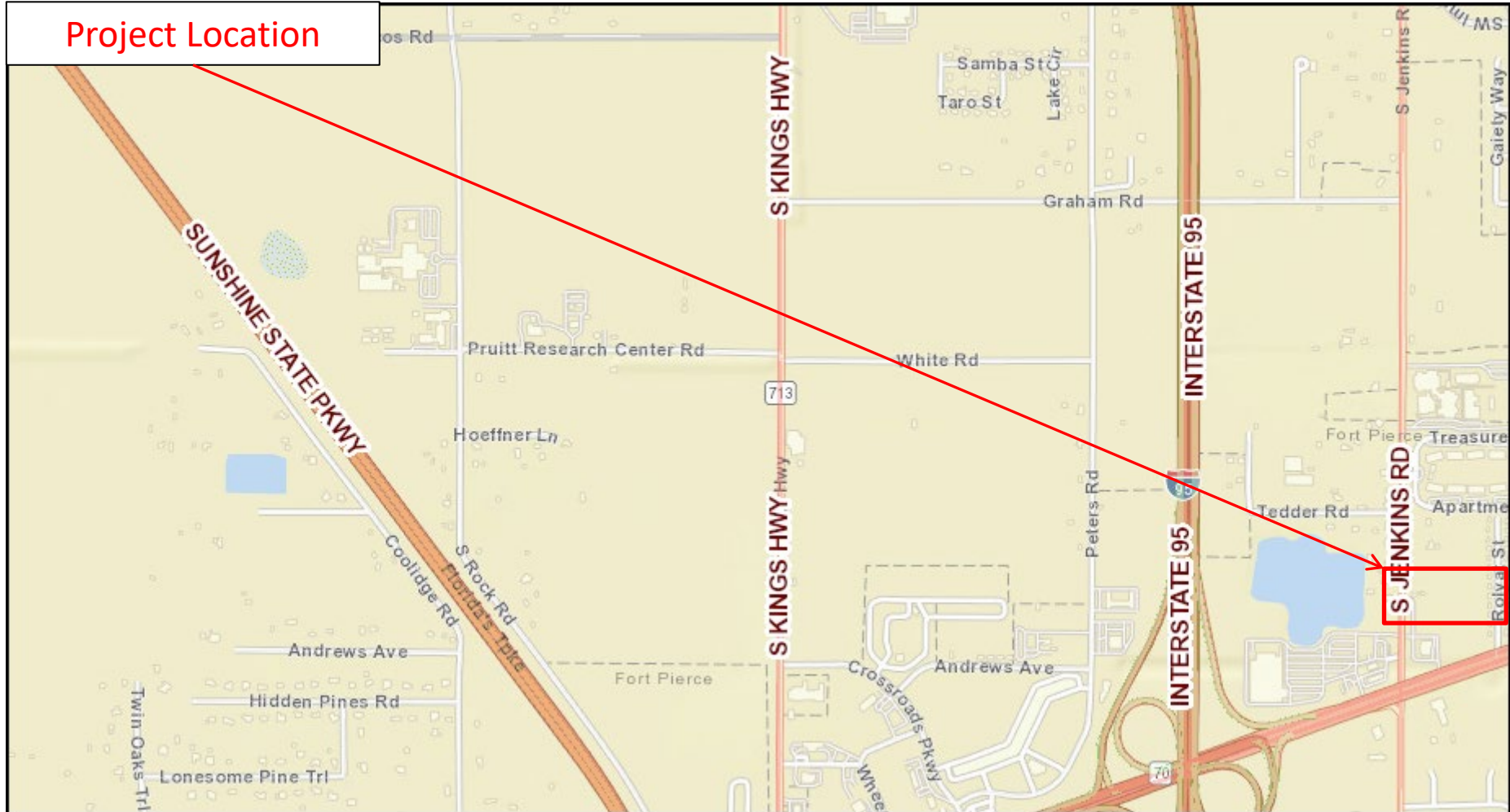



Environmental Assessment

Jenkins Road
Fort Pierce, St. Lucie County, FL

Property Appraiser Map

Project: 21-241

Flagship Companies

04/23/2021

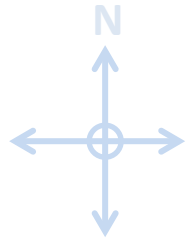



Environmental Assessment

Jenkins Road
Fort Pierce, St. Lucie County, FL

Soil Map

Project: 21-241

Flagship Companies

04/23/2021

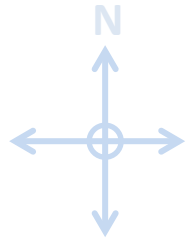

St. Lucie County, Florida (FL111)			
St. Lucie County, Florida (FL111)			
Map Unit Symbol	Map Unit Name	Acres in AOI	Percent of AOI
25	Nettles and Oldsmar sands	4.3	100.0%
Totals for Area of Interest		4.3	100.0%



Environmental Assessment

Jenkins Road

Fort Pierce, St. Lucie County, FL

Florida Land Use, Cover and Forms Classification System (FLUCCS) Map

Project: 21-241

Flagship Companies

04/23/2021

