

**May 17, 2023**



**CITY OF FORT PIERCE**

**ANNUAL CONTRACT FOR PLAN REVIEW SERVICES**

**RFP NO. 2023-039**

**ADDENDUM NO. 1**

The purpose of this addendum is to advise vendors that minor changes were inadvertently overlooked in preparation of the proposal documents. Please disregard the original document and use the **REVISED** proposal document, attached for preparing your submission.

All other conditions of this bid remain the same.

Please acknowledge receipt of this addendum and include it with your submittal.

Signature: \_\_\_\_\_

Manual

Signature: \_\_\_\_\_

Typed or Printed

Company Name: \_\_\_\_\_

Address: \_\_\_\_\_

Date: \_\_\_\_\_

*[Handwritten Signature]*  
*Joseph Payne*  
*JPI*  
*5995 S A1A*  
*Melbourne Beach, FL*  
*32951*

/lh

<p><b>DELIVER TO:</b>  City of Fort Pierce, Purchasing Division  Room 101  100 North U.S. #1  Fort Pierce, FL 34950</p> <p><b>MAIL TO:</b>  City of Fort Pierce Purchasing Division,  Room 101  P.O. Box 1480  Fort Pierce, FL 34954-1480</p>	<p align="center"><b>CITY OF FORT PIERCE</b></p>  <p align="center"><b>REQUEST FOR PROPOSALS  and  PROPOSER ACKNOWLEDGMENT</b></p>
<p><b>Bid Writer:</b> Georgia Montgomery, 772-467- 3102</p>	<p><b>RFP No:</b> 2023-039</p>
<p><b>Pre-Proposal Conference Date:</b>  11:00AM, MONDAY, MAY 22, 2023</p>	<p><b>RFP Title:</b> ANNUAL CONTRACT FOR  PLAN REVIEW SERVICES</p>
<p><b>Pre-Proposal Location:</b>  CITY HALL, 1ST FLOOR CONFERENCE  ROOM 100 N. US HIGHWAY 1, FORT PIERCE,  FL</p>	<p><b>RFP Opening Location:</b>  City of Ft. Pierce Purchasing Division  Room 101  100 North U.S. #1, 1st Floor  Ft. Pierce, Florida 34950</p>
<p><b>RFP Due Date &amp; Time:</b>  3:30 PM, TUESDAY, JUNE 6, 2023</p>	<p>If you need any reasonable accommodation for any type of disability in order to participate in this procurement, please contact this department as soon as possible.</p>
<p><b>Proposer Name:</b> JPI  -----  <b>Mailing Address:</b> 5995 S A1A, Melbourne FL  32951</p>	<p><i>I hereby certify that this bid is made without prior understanding, agreement, or connection with any corporation, firm, or person submitting a bid for the same materials, supplies or equipment, and is in all respects fair and without collusion or fraud. I agree to abide by all conditions of this bid and certify that I am authorized to sign this bid for the bidder.</i></p> <p>X _____  Authorized Signature (Manual)</p>
<p>5995 S A1A, Melbourne FL 32951 :</p>	<p>Joseph Payne</p>
<p><b>Type of Entity (Select one):</b>  Corporation <input checked="" type="checkbox"/> _____  Partnership _____  Proprietorship _____</p>	<p>President</p>
<p>Incorporated in FL 2010</p>	<p>30 _____ days, ARO</p>
<p>813.520.1683</p>	<p>Payment Terms: Net 30 Days</p>
<p>813.520.1683</p>	<p>80 064 0420</p>
<p>joe@jpiflorida.com</p>	<p>Local Business: ___Y ___x_N MWBE: ___Y ___x_N</p>
<p>Bid Security is attached, when required, in the amount of \$ _____  F.O.B. DESTINATION</p>	<p>If returning as a "No Bid" state reason:</p>
<p align="center"><b>THIS PAGE MUST BE COMPLETED AND RETURNED WITH YOUR BID</b></p>	



**RFP No. 23-039**

**Annual Contract for Plan Review Services**

**Submitted to:**

City of Fort Pierce – Purchasing Division  
100 North U.S. #1  
Fort Pierce, FL 34954

**Contact:**

Paul Thomas, Building Official  
Phone: 727-489-3194  
Email: [frseaffer@cityoffortpierce.com](mailto:frseaffer@cityoffortpierce.com)

By:

June 6<sup>th</sup> at 3:30pm (EST) (Date of Proposal)

From:



5995 S A1a  
Melbourne, FL 32951  
c/o Joe Payne, PE MBA  
[joe@jpiflorida.com](mailto:joe@jpiflorida.com)/ 813-520-1683

Submittal: Demandstar website



## **JPI TABLE OF CONTENTS**

JPI provides the following Table of Contents for the major areas of the response. This report consecutively numbers all pages in the footer.

Section 1	LETTER OF TRANSMITTAL	1-2
Section 2	ORGANIZATION PROFILE AND QUALIFICATIONS	3-17
Section 3	GENERAL INFORMATION	18-19
Section 4	CERTIFICATES	20
Section 5	FINANCIAL DATA	21
Section 6	SCOPE OF WORK	22-29
Section 7	ADDITIONAL DATA	30



## LETTER OF TRANSMITTAL

June 5<sup>th</sup>, 2023

RFP No. 2023-039

City of Fort Pierce, Purchasing Division  
Room 101  
100 North U.S. #1  
Fort Pierce, FL 34950

### ANNUAL CONTRACT FOR PLAN REVIEW SERVICES

Dear Mr. Thomas and Members of the Evaluation Committee,

JPI is pleased to present our response to this advertisement. JPI appreciates the opportunity to submit our qualifications on this contract. **JPI has served the St. Lucie County Building Department since 2018 and wished to begin a relationship with the City of Fort Pierce.** JPI is 100 percent committed to government services, has no private industry clients, and has zero conflicts to the work of this contract. Please let this letter serve as our formal agreement to be bound by the submittal without modifications unless mutually agreed to upon further negotiations between The City and JPI. We have been in business for 13 years. We are qualified under the laws, rules, and regulations of the State of Florida to perform the work required by these contract documents. Our sunbiz.org document number is P10000059808 and Joe Payne is a Professional Engineer with a PE license of 55751. JPI assures our ability to meet the insurance and performance requirements set out in this RFP if selected for award. We certify we maintain a drug-free workplace program compliant with the standards within Florida Statutes § 440.102.

JPI's specialization is providing professional services to Building Departments, which is the purpose of this advertisement. JPI has a municipal service line dedicated 100% to serving public agencies with no conflicts of interest. JPI has local staff throughout the twenty municipalities that we service in the Tampa Bay area. As a summary of past experience supporting JPI's qualifications to perform these professional services, we offer the following:

1. JPI has worked in the area since 2018 over the course of our contract with St. Lucie County, through their reciprocal agreement with the County.
2. JPI routinely completes plan review for work within unincorporated St. Lucie County with a Fort Pierce post office address.



3. JPI is the consultant for numerous building departments in the Treasure Coast area including Martin County, City of Stuart, Indian River County, Brevard County, City of Melbourne, City of Palm Bay and in Okeechobee County.
4. Since 2018, JPI plan reviewers completed an estimated 10,000 plan reviews for St. Lucie County many of which were local to the City.
5. The Project Manager, Joe Payne, is the President of JPI and has 100% control of all resources proposed for RFP 2023-039, and fully commits to use these resources.
6. The JPI President will come out of the office to fulfill service requests on this contract.
7. JPI proposes professionals possessing all required licensure within this RFP. JPI proposes more than ten five back-up plans examiners to begin any future work.
8. JPI has a municipal service line which currently is 100% committed to servicing Building Departments.
9. JPI has personnel available currently to service in-house plan examiner roles.
10. JPI has local staff who will serve this contract.

**Joe Payne, PE** will be the binding agent and point of contact for this contract. Mr. Payne is the President of the company and a professional engineer with 30 years of experience. He will be the project manager for this contract #2023-039 and takes responsibility for review services. JPI is a Florida Owned Corporation and a statewide Professional Service firm. JPI was founded in 2010 after servicing state contracts as a sole proprietor for several years. The municipal service line is the primary source of business revenue for JPI. We look forward to working with The City.

In closing, JPI thanks you for the opportunity to submit on Contract 2023-039 and JPI wishes to establish an excellent working relationship with the City of Fort Pierce.

Sincerely,

Joe Payne, PE, President

[joe@jpiflorida.com](mailto:joe@jpiflorida.com)

800-488-1956





3. JPI is the consultant for numerous building departments in the Treasure Coast area including Martin County, City of Stuart, Indian River County, Brevard County, City of Melbourne, City of Palm Bay and in Okeechobee County.
4. Since 2018, JPI plan reviewers completed an estimated 10,000 plan reviews for St. Lucie County many of which were local to the City.
5. The Project Manager, Joe Payne, is the President of JPI and has 100% control of all resources proposed for RFP 2023-039, and fully commits to use these resources.
6. The JPI President will come out of the office to fulfill service requests on this contract.
7. JPI proposes professionals possessing all required licensure within this RFP. JPI proposes more than ten five back-up plans examiners to begin any future work.
8. JPI has a municipal service line which currently is 100% committed to servicing Building Departments.
9. JPI has personnel available currently to service in-house plan examiner roles.
10. JPI has local staff who will serve this contract.

**Joe Payne, PE** will be the binding agent and point of contact for this contract. Mr. Payne is the President of the company and a professional engineer with 30 years of experience. He will be the project manager for this contract #2023-039 and takes responsibility for review services. JPI is a Florida Owned Corporation and a statewide Professional Service firm. JPI was founded in 2010 after servicing state contracts as a sole proprietor for several years. The municipal service line is the primary source of business revenue for JPI. We look forward to working with The City.

In closing, JPI thanks you for the opportunity to submit on Contract 2023-039 and JPI wishes to establish an excellent working relationship with the City of Fort Pierce.

Sincerely,

A handwritten signature in blue ink, appearing to read "Joe Payne", is written over a light blue background.

Joe Payne, PE, President

[joe@jpiflorida.com](mailto:joe@jpiflorida.com)

800-488-1956





## ORGANIZATION PROFILE AND QUALIFICATIONS

JPI has served the St. Lucie County Building Department since 2018

JPI is a statewide professional service firm, primarily serving municipal clients; specifically, building departments. JPI is a civil engineering company with a broad range of in-house professionals including Building Code Administrator professionals, Architects, and Engineers. JPI services over thirty similar clients, including the St. Lucie County Building Department. Joe Payne, PE, the Founder and President will serve as the Project Manager. Kevin Singley, CBO, Pete Swarr, PE, Scott Seigel, PE,

and Andrew Manero, RA, are key/ primary individuals planned for this work. See the provided resumes for their experience. JPI's current production capacity is 1800 man-hours per week. Our current weekly commitment equals 1400 man-hours per week. We have a surplus capacity of 400 man-hours per week, ten full time equivalents, to service this contract. JPI has thirty licensed plan reviewers available and the President, Mr. Payne, does perform plan review services for JPI when needed by the client.

JPI has no conflicts of interest to this contract.

Joe Payne, PE, will be the binding agent and point of contact and Project Manager for this contract. Mr. Payne is the President of the company and a professional engineer with 30 years of experience. He has over 30 years of construction and engineering experience. He is a multi-discipline engineer well suited for the role of managing this RFP, which is a multi-discipline plans review contract. JPI is a Florida Owned Corporation and a statewide Professional Service firm. JPI was founded in 2010 after servicing state contracts as a sole proprietor for several years. The municipal service line is the primary source of business revenue for JPI. In closing, JPI thanks you for the opportunity to bid on this contract and JPI wishes to establish an

excellent working relationship with the City. JPI has a staff of 45 professionals including full-time and part-time personnel. JPI will not subcontract any services under this contract. JPI only services municipal clients at this time, we have not private industry clients at this time, and are





completely committed to serve the City without conflict. Over the last decade, JPI completed approximately 50,000 man-hours of plan review work for building departments, and we estimate approximately 50,000 plan reviews. Reviews vary from over-the-counter reviews such as roof permits to multi-store commercial high-rise hotels. A unique reason to continue to select JPI is that JPI already performs these services statewide in Florida with current staffing who are available for the work.

JPI has completed an estimated 50,000 plan reviews in ten years.

JPI will handle variable service levels on this contract.

The main benefit that JPI provides with our applied knowledge is **PROBLEM SOLVING**. This allows JPI to efficiently solve problems provided by the community during the application process. JPI provides a depth of services to our clientele with a variety of professionals including Engineers and Architects. This depth allows JPI to consider multi-discipline approaches to problems through our multi-discipline expertise. JPI has a competitive operational advantage to servicing this contract. The contract likely requires *variable service levels which may change weekly and daily*. JPI staffing includes part-time personnel and on-call personnel, who may become available to complete this contract

on short notice. In addition, from our statewide presence, JPI has the financial resources to sustain staffing long term on this contract, even during periods when the City has zero service needs. Conversely, JPI also has the staffing resources to quickly increase to a production level of ten employees per week, with very little notice. JPI has the capacity to handle both high and low volume at any time.

JPI has no current private industry clients.

JPI is the consultant for numerous building departments in the area including St. Lucie County, Martin County, Okeechobee School Board, and previously Indian River County. Also, we serve Brevard County, City of Melbourne, City of Palm Bay, City of Titusville, Indian Harbour Beach, and Cape Canaveral. Expanding, we service Lake County, City of Clermont, City of Altamonte Springs, City of Lake Mary, and City of Fernandina Beach. Also, we have a statewide presence through servicing agencies such as the City of Clearwater, City of Largo, City of St. Pete Beach, City of St. Petersburg, City of Treasure Island, City of

South Pasadena, Town of Redington Shores, City of Pinellas Park, City of Tampa, Hillsborough County, and City of Tarpon Springs. JPI is a consultant for Sarasota County, City of Anna Maria, Town of Longboat Key, Charlotte County, and Lee County Florida.



The following organizational charts provide the Key Staff members for this contract. Consider them the first source of professionals for work:

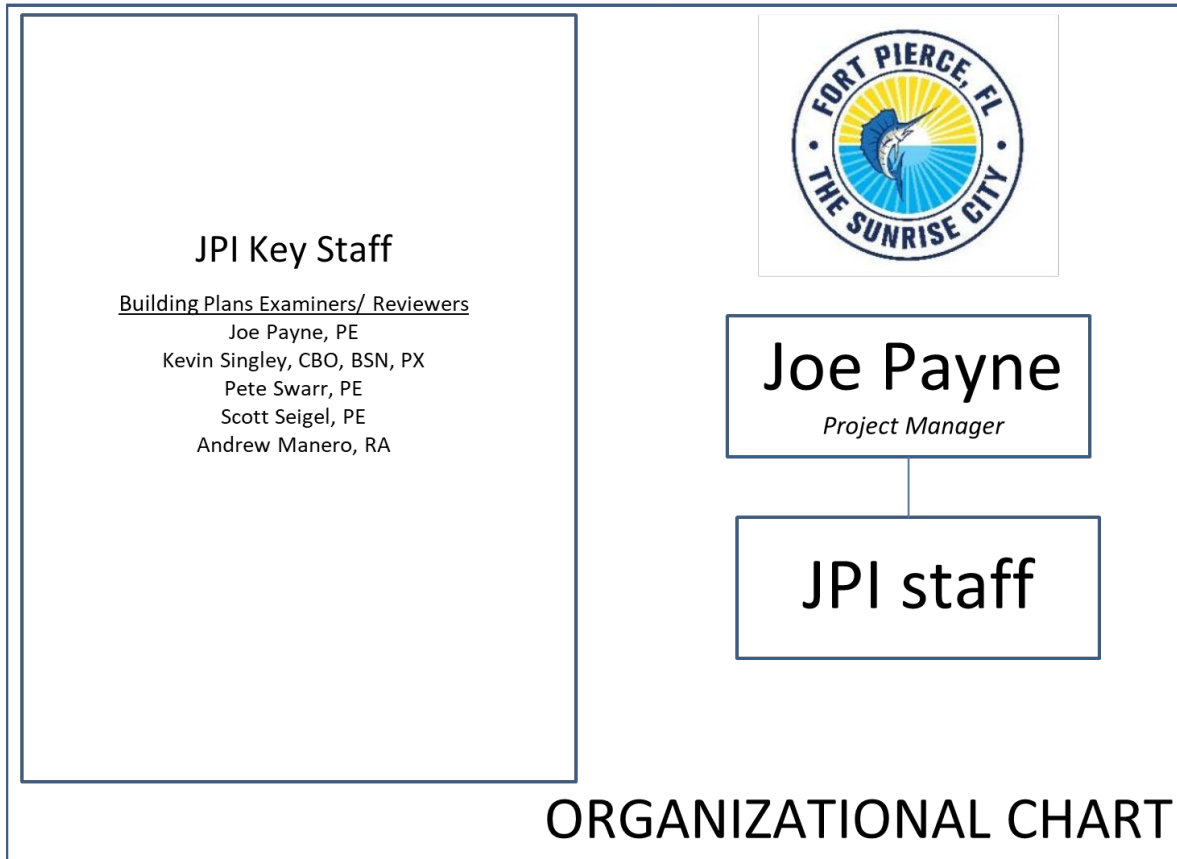

The following summarizes our professional licensure for current employees:



<u>JPI</u>	<u>DBPR</u>
Joe Payne	FLPE55751
Greg Perlin	BN6576
Jorge Cedeno	BN4702
Jack McCabe	BN4613
Jason Steele	FLPE69234
Cory Brockett	FLPE74677
Bob Hightower	BN2430
Doug Walton	AR0007045
Greg Martin	BN3947, PX1848
Andrew Mareno	AR96338
Eddie Page	FLPE69045
Pete Swarr	FLPE44159
Robert Bryce	PX2783
Scott Seigel	FLPE60980
Andrew West	FLPE60301
Dan Folwell	BN6927
Rick Hoepner	FLPE23319
Ryan Ferry	BN6617
Mark Thornbloom	FLPE50107
Jon Thomas	BN7125
Kevin Singley	PX3601, BN4798, BU1872
Micheal Tew	PX2675, BN5003
Tony Murphy	AR100424
Luke Curtis	BU1975,RPX279,PX3717, CN6614
James Crouch	BN8698
Glenn Hall	PX3599, BN5324
Robert Peck	BN7567
Ezz Elgayar	BN6415



We provide the following five key references and also ten additional references:

- 1) **City of Palm Bay** - Valentino Perez, CBO, City of Palm Bay, 321-726-5614
- 2)

Interim Building Official and Multi-trade Inspection Services and Plans Examination Services.  
Also, Public Works professional services.

*Joe Payne, Kevin Singley, Andrew Manero, Pete Swarr, Scott Seigel, Abraham Chabab, and Jorge Cedeno have worked on this contract. 2016 to current status – Approximately \$2.2M of services. **Three contract renewals.***

- 2) **St. Lucie County Government** - Monica Graziani | Building & Code Regulation Manager, Planning & Development Services, Ph: 772-462-1599 | 2300 Virginia Avenue, Fort Pierce, FL 34982, grazianim@stlucieco.org | [www.stlucieco.org](http://www.stlucieco.org)

Interim Building Official and Multi-trade Inspection Services and Plans Examination Services.  
*Joe Payne, Andrew Manero, Pete Swarr, Scott Seigel, and James McGuinness have worked on this contract/ 2018 to current status- approximately \$2.0M of services. **Four contract renewals.***

- 3) **Indian River County Government** - Scott P. McAdam, CBO, MCP, Building Official, Indian River County, Phone (772)226-1268, Fax (772) 770-5333.

Multi-trade Inspection Services and Plans Examination Services  
*2017 to current status – approximately \$1M of services.*

- 4) **Brevard County Government** – Terry Talbert, CBO  
2725 Judge Fran Jamieson Way, Viera, Fl 32940, 321-633-2072 Ex. 52678/Fax 321-633-2087

Multi-trade Inspection Services and Plans Examination Services  
*Joe Payne, Doug Walton, Greg Martin, Pete Swarr, Rick Hoepner, Scott Seigel, Mark Thornbloom, Andrew Manero, John Wiggins, and Andrew Chabab have worked on this contract/ 2016 to current status– approximately \$4M of services. **Three contract renewals.***

- 5) **City of Melbourne** - Steve Innes BCA FCA CFM | Building Official, Ph: 321-608-7926 | 900 E Strawbridge Ave, Melbourne, FL 32901, Steve.Innes@mlbfl.org|

Multi-trade Inspection Services and Plans Examination Services.  
*Joe Payne, Andrew Manero, Greg Martin, and Scott Seigel have worked on this contract/ 2016 to current status- approximately \$0.5M of services. **Three contract renewals.***



1) **City of Clearwater - Kevin Garriott, CBO, 727-562-4567**

SCOPE: Multi-trade Inspection Services and Plans Examination Services.

DATE OF SERVICE: 2016- Current. *Three contract renewals.*

RESPONSIBILITIES: *Joe Payne, John Fahey, Joe Aukstikalnis, David Wilcox, Cory Brockett, and Greg Perlin. 2016 to current status – Approximately \$1.2M of services. All work is completed within budget and schedule. The following summarizes our responsibilities:*

- Commercial and Residential Professional Service Experience: JPI staffs the contract with up to three daily inspectors throughout the life of the contract. In addition, JPI provides up to two in-house plan review professionals as needed by the City to target a ten-day turnaround for reviews. JPI utilizes ePermits for inspections and plan reviews. Completes residential and commercial inspections and plans review.
- Firm and Staff Contract Experience: All full-time staff on the contract are fully licensed as Engineers, Architects, or Building Code professionals and complete multi-trade assignments. JPI provides licensed CFMs for floodplain work. **JPI provides licensed commercial and residential plan reviewers (multi-trade) and provides licensed commercial and residential inspectors (multi-trade).**
- Costs: JPI provides a daily 25-50% cost savings to the City through the use of multi-trade professionals. For example, JPI professionals are licensed for both residential and commercial work, could have one professional handle both in a route, rather than needing two professionals. There were no change orders.



## 2) City of St. Pete Beach – Julie Anderson, CBO, 727-363-9244

SCOPE: Multi-trade Inspection Services and Plans Examination Services

DATE OF SERVICE: 2022- Current. *Sole source vendor*

RESPONSIBILITIES: *Joe Payne, Luke Curtis, Jon Thomas, Ryan Ferry, and Scott Seigel, have worked on this contract. 2022 to current status – Approximately \$0.1M of services. All work is completed within budget and schedule. The following summarizes our responsibilities:*

- Commercial and Residential Professional Service Experience: JPI staffs the contract typically with one daily inspector throughout the life of the contract. In addition, JPI provides remote commercial and multi-family residential plan review (iWorq) as needed by the City to target a ten-day turnaround for reviews. JPI works remotely and receives assignments from iWorq. JPI enters results electronically. Completes residential and commercial inspections and plans review.
- Firm and Staff Contract Experience: JPI provides both inspection and plans review services during the contract. All full-time staff on the contract are fully licensed as Engineers, Architects, or Building Code professionals and complete multi-trade assignments. **JPI provides licensed commercial and residential plan reviewers (multi-trade) and provides licensed commercial and residential inspectors (multi-trade).**
- Costs: JPI provides a daily 25-50% cost savings to the City through the use of multi-trade professionals. JPI covered vacation leave for City personnel on routine occasions. There were no change orders.



### 3) **Pinellas County** – *Eve Spencer, CBO, AIA, 727-464-3752*

SCOPE: Multi-trade Inspection Services and Plans Examination Services.

DATE OF SERVICE: 2013- *Current. **Four contract renewals. Two renewals as sole source.***

RESPONSIBILITIES: *Joe Payne, Jack McCabe, Jon Thomas, Bob Hightower, David Wilcox, Cory Brockett, Andrew Manero, Scott Seigel and Greg Perlin. 2013 to current status – Approximately \$7.0M of services. All work is completed within budget and schedule. The following summarizes our responsibilities:*

- Commercial and Residential Professional Service Experience: JPI staffs the contract with up to ten daily inspectors throughout the life of the contract. In addition, JPI is an interim in-house plan review professional to target a ten-day turnaround for reviews. JPI utilizes hard copy tickets for inspections which were received at a standing morning meeting. Completes residential and commercial inspections.
- Firm and Staff Contract Experience: All full-time staff on the contract are fully licensed as Engineers, Architects, or Building Code professionals and complete multi-trade assignments. *For periods of time, JPI is the sole vendor for the Department completing up to 250 daily inspections. **JPI provides licensed commercial and residential plan reviewers (multi-trade) and provides licensed commercial and residential inspectors (multi-trade).***
- Costs: JPI provides a daily 25% cost savings to the County through the use of multi-trade professionals. For example, JPI professionals are licensed for both residential and commercial work, could have one professional handle both in a route, rather than needing two professionals. There were no change orders.



4) **City of Tarpon Springs** – *Kevin Powell, CBO, CFM, 727-942-5604*

SCOPE: Multi-trade Inspection Services and Plans Examination Services

DATE OF SERVICE: 2017- *Current. **Three contract renewals/ Two renewals as sole source.***

RESPONSIBILITIES: *Joe Payne, Ezz Elgayar, and Cory Brockett, have worked on this contract. 2017 to current status – Approximately \$0.3M of services. All work is completed within budget and schedule. The following summarizes our responsibilities:*

- Commercial and Residential Professional Service Experience: JPI staffs the contract typically with one daily inspector throughout the life of the contract. In addition, JPI provides remote commercial and multi-family residential plan review as needed by the City to target a ten-day turnaround for reviews. JPI utilizes hard tickets to complete inspections with a brief daily AM meeting in the office. Completes residential and commercial inspections and plans review.
- Firm and Staff Contract Experience: JPI provides both inspection and plans review services during the contract. All full-time staff on the contract are fully licensed as Engineers, Architects, or Building Code professionals and complete multi-trade assignments. **JPI provides licensed commercial and residential plan reviewers (multi-trade) and provides licensed commercial and residential inspectors (multi-trade).**
- Costs: JPI provides a daily 25-50% cost savings to the City through the use of multi-trade professionals. JPI covered vacation leave for City personnel on routine occasions. There were no change orders.





5) **City of Clermont - Mark A. Grenier, CBO, MCP, 352.241.7311**

SCOPE: Commercial and Residential Building Inspection & Plans Review Services

DATE OF SERVICE: 2019- Current. *Two contract renewals.*

RESPONSIBILITIES: *Joe Payne, Cory Brockett, Tony Murphy, Rick Hoepner, Mark Thornbloom, Luke Curtis, and Scott Seigel have worked on this contract. 2019 to current status – Approximately \$0.5M of services. All work is completed within budget and schedule. The following summarizes our responsibilities:*

- Commercial and Residential Professional Service Experience: JPI staffs the contract with up to three daily inspectors throughout the life of the contract. JPI provides weekly staffing schedules for Mr. Spears and Mr. Grenier. JPI provides daily results to Mr. Spears and as needed Mr. Colvin and Ms. Roderick. JPI works under eTrackit and related technologies by CRW systems/ Superion.
- Firm and Staff Contract Experience: JPI completes multi-trade residential and commercial inspections. All full-time staff on the contract are fully licensed as Engineers, Architects, or Building Code professionals and complete multi-trade assignments. **JPI provides licensed commercial and residential inspectors (multi-trade) and has staff available for licensed commercial and residential plan reviewers (multi-trade).**
- Costs: JPI provides a daily 50% cost savings to the City through the use of multi-trade professionals. For example, JPI professionals are licensed for both residential and commercial work and could have one professional handle both in a route, rather than needing two professionals. There were no change orders.



6) **Hillsborough County** – David M. Anthony, Chief Mechanical Inspector, 813-335-7570

SCOPE: Multi-trade Inspection Services and Plans Examination Services.

DATE OF SERVICE: 2016- Current. *Three contract renewals.*

RESPONSIBILITIES: *Joe Payne, Jason Steele, Daniel Folwell, Pat Nolan, Michael Tew, and Julie Daniels have worked on this contract. 2016 to current status – Approximately \$6.0M of services. All work is completed within budget and schedule. The following summarizes our responsibilities:*

- Commercial and Residential Professional Service Experience: JPI staffs the contract with up to twelve daily building inspectors throughout the life of the contract. In addition, JPI provides two in-house plan review professionals as needed by the County to target a ten-day turnaround for reviews. Completes residential and commercial inspections and plans review.
- Firm and Staff Contract Experience: All full-time staff on the contract are fully licensed as Engineers, Architects, or Building Code professionals and complete multi-trade assignments. **JPI provides licensed commercial and residential plan reviewers (multi-trade) and provides licensed commercial and residential inspectors (multi-trade).**
- Costs: JPI provides staffing to the County to meet high volume demand. JPI is the primary vendor on this contract. There were no change orders.



## 7) City of Largo – Matt Butler, CBO, 727-586-7488

SCOPE: Multi-trade Inspection Services and Plans Examination Services

DATE OF SERVICE: 2019- Current. *Two contract renewals.*

RESPONSIBILITIES: *Joe Payne, Luke Curtis, Jon Thomas, and Robert Peck, have worked on this contract. 2019 to current status – Approximately \$0.3M of services. All work is completed within budget and schedule. The following summarizes our responsibilities:*

- Commercial and Residential Professional Service Experience: JPI staffs the contract typically with one daily inspector on call through the life of the contract. JPI uses a tablet to receive and enter results and has on occasion used a hard ticket system. Completes residential and commercial inspections and plans review.
- Firm and Staff Contract Experience: JPI provides both inspection and plans review services during the contract. All full-time staff on the contract are fully licensed as Engineers, Architects, or Building Code professionals and complete multi-trade assignments. **JPI provides licensed commercial and residential plan reviewers (multi-trade) and provides licensed commercial and residential inspectors (multi-trade).**
- Costs: JPI provides a daily 25-50% cost savings to the City through the use of multi-trade professionals. JPI covered vacation leave for City personnel on routine occasions. There were no change orders.



## 8) City of South Pasadena – Terri Sullivan, CBO, 727-343-4192

SCOPE: Multi-trade Inspection Services and Plans Examination Services

DATE OF SERVICE: 2022- Current. *Sole source vendor.*

RESPONSIBILITIES: *Joe Payne, Luke Curtis, Jon Thomas, and Robert Peck, have worked on this contract. 2022 to current status – Approximately \$0.1M of services. All work is completed within budget and schedule. The following summarizes our responsibilities:*

- Commercial and Residential Professional Service Experience: JPI staffs the contract typically with one daily inspector on call through the life of the contract. JPI uses a hard ticket system. Completes residential and commercial inspections and plans review.
- Firm and Staff Contract Experience: JPI provides both inspection and plans review services during the contract. All full-time staff on the contract are fully licensed as Engineers, Architects, or Building Code professionals and complete multi-trade assignments. **JPI provides licensed commercial and residential plan reviewers (multi-trade) and provides licensed commercial and residential inspectors (multi-trade).**
- Costs: JPI provides a daily 25-50% cost savings to the City through the use of multi-trade professionals. JPI covered vacation leave for City personnel on routine occasions. There were no change orders.



## 9) City of Palm Bay - Valentino Perez, CBO, 321-726-5614 (expanded reference description)

SCOPE: Interim Building Official and Multi-trade Inspection Services and Plans Examination Services. Public Works Services.

DATE OF SERVICE: 2016- Current. *Three contract renewals.*

RESPONSIBILITIES: *Joe Payne, David Wilcox, Kevin Singley, Andrew Manero, Pete Swarr, Scott Seigel, Abraham Chabab, and Jorge Cedeno have worked on this contract. 2016 to current status – Approximately \$2.2M of services. All work is completed within budget and schedule. The following summarizes our responsibilities:*

- Commercial and Residential Professional Service Experience: JPI staffs the contract with up to eight daily inspectors throughout the life of the contract. In addition, JPI provides an in-house and remote plan review as needed by the City to target a ten-day turnaround for reviews. JPI utilizes HTE Mars, Naviline, BlueBeam, and Central Square on tablets and in the office. Completes residential and commercial inspections and plans review. On most days, JPI is the senior in-house plans reviewer and also responds to desk questions.
- Firm and Staff Contract Experience: JPI provides an Interim CBO on three separate occasions during the life of the contract. All full-time staff on the contract are fully licensed as Engineers, Architects, or Building Code professionals and complete multi-trade assignments. JPI provides licensed engineers and licensed CFMs for floodplain work. JPI staff also possess multiple cross-discipline licenses including stormwater pollution prevention. **JPI provides licensed commercial and residential plan reviewers (multi-trade) and provides licensed commercial and residential inspectors (multi-trade).**
- Costs: JPI provides a daily 50% cost savings to the City through the use of multi-trade professionals. For example, JPI professionals are licensed for both residential and commercial work and could have one professional handle both in a route, rather than needing two professionals. JPI provides a 40% cost savings as the interim building official through providing a work plan that isolated 24 hours per week of work that required a CBO license from 16 hours per week of administrative work within the CBO office. There were no change orders.



## 10) **City of Titusville** - *Steve Adams, CBO, 321.567.3982*

SCOPE: Commercial and Residential Building Inspection & Plans Review Services

DATE OF SERVICE: 2017- *Current. **Two contract renewals.***

RESPONSIBILITIES: *Joe Payne, Mark Thornbloom, Cory Brockett, Rick Hoepner, and Scott Seigel have worked on this contract. 2017 to current status – Approximately \$0.4M of services. All work is completed within budget and schedule. The following summarizes our responsibilities:*

- Commercial and Residential Professional Service Experience: JPI staffs the contract with up to three daily inspectors throughout the life of the contract. JPI provides weekly staffing schedules to Mr. Adams and Mr. Abel. JPI attended a daily 730am meeting to receive a hard ticket route and emailed results daily.
- Firm and Staff Contract Experience: JPI completes multi-trade residential and commercial inspections. All full-time staff on the contract are fully licensed as Engineers Architects or Building Code professionals and complete multi-trade assignments. **JPI provides licensed commercial and residential inspectors (multi-trade) and had staff available for licensed commercial and residential plan reviewers (multi-trade).**
- Costs: JPI provides a daily 50%-75% cost savings to the City through the use of multi-trade professionals. For example, JPI professionals are licensed for both residential and commercial work and could have one professional handle both in a route, rather than needing two professionals. There were no change orders.



# **Joseph Payne PE, MBA**

## Curriculum Vitae

### **Credentials**

Professional Engineer  
Florida License #55751  
Georgia License #33995  
Delaware License #15439 (inactive status)

### **Corporate Office**

5995 S A1A  
Melbourne, FL 32951

### **Mailing Address**

16057 Tampa Palms Blvd. , #242  
Tampa, FL 33647

### **Phone**

Cell: 813.731.1501

### **Internet**

E-mail: [joe@jpiflorida.com](mailto:joe@jpiflorida.com)

### **Education**

Masters of Business Administration  
University of South Florida, Tampa, Florida

Bachelor of Science in Civil Engineering  
Drexel University, Philadelphia, Pennsylvania

Graduate studies (Geotechnical Engineering- 1998)  
New Jersey Institute of Technology, Newark, New Jersey

### **Continuing Education:**

Florida Department of Financial Services (Neutral Evaluation) –2013  
Florida Department of Financial Services (Mediation) - 2014  
Florida Civil Circuit Court Mediator - (Pending 2014)  
1802 Wind Hazard Mitigation Training – April 2011  
Advanced MOT Work Zone – 2005  
Amtrak Contractor Safety Training - 1999  
OSHA 40 Hour Hazwoper – 1997

---

### **Professional Associations**

Florida Board of Professional Engineers, Case Reviewer  
Hillsborough County Plumbing Board of Adjustment, Appeals and Examiners (Engineer)  
Hillsborough County Land Use Appeals Board (2009-2010)  
Westchase Association Board of Directors (2007-2009)

## **Areas of Concentration**

Municipal Services  
Quality Assurance and Control Manager  
General Civil/ Site Engineering  
Public Sector Market Development  
Environmental Resource Permitting  
Pond Siting Reports  
D.O.T. Drainage Connection Permits  
Public Meetings

---

## **Professional Experience**

### ***Joe Payne Inc., Tampa, FL 2009-current***

#### **President**

President of a full service civil engineering firm. Owner and Principal-In-Charge of three service lines (Municipal Service Line, Civil/Site Engineering, and State/ Federal). Consultant for thirty-five municipalities in the State of Florida. Provide professional opinions and consultation. Within the Municipal Service Line, common activities include Interim Building Official coverage, Residential and Commercial plan review (office and remote), and Residential and Commercial Inspector (paper based and tablet). Quality Control Officer for JPI.

Consultant for the Florida Board of Engineers. Complete plan reviews and provide professional opinions for complaint cases involving building code, sinkhole, site plans, inspections, and related professional activities. Provide professional opinions.

Consultant for the Florida Department of Financial Services. Engineering and Financial Management consultation.

Completed neutral evaluation for Department of Financial Services for sinkhole loss verifications and remediation methods. Cases in Hillsborough, Hernando, Pasco, Highlands, and other counties throughout Florida.

### ***Louis Berger Group, Inc., Florida Statewide, 2013-2014***

#### **Special Consultant – Contract Role**

Consultant for Louis Berger Group Florida Statewide marketing and business development pursuits. Project Manager for several Design-Build pursuits with a large international Design-Build contractor in South Florida. Project Manager for pursuits along SR 826 and HEFT. Proposal Manager for the Louis Berger team on the I-4 Ultimate P3 project. Proposal Manager for the Interstate Program Manager pursuit and Emergency Response General Consultant pursuits for FDOT.

### ***Greenhorne & O'Mara, Clearwater, FL 4/08 to 8/09***

#### **Project Director**

Worked as a Project Manager and Technical Director for a nationally ranked general civil and transportation consulting firm located in Tampa Bay. Project Manager for professional service contracts in the one million to three million dollar range. Won the



Hillsborough County TTF-2a contract at Broadway and Falkenburg which was the first Hillsborough County public works contract at the office. Closed FDOT Design-Build contracts for work in FDOT 2. Brought in construction permitting and dewatering contracts for work in Collier County. Set-up teaming agreements for contracts for FDOT Design-Build projects and shortlisted on D4 work. Project Director for Hillsborough County Public Works contracts. Assists the Office Manager in reaching \$2.5 million dollar sales goal for public sector clients, primarily City, County, and alternate bid FDOT projects. Corporate restructuring led me to pursue a new home to continue my career.  
*References: Matt Fabrizio (Frmr. Project Manager), 727.423.0202*

***TY Lin, Inc., Tampa, FL 7/05 to 4/08***

Associate/ Project Manager

Project Manager and Technical Lead Drainage Engineer for the Tampa Business Unit of an international structural and transportation engineering firm. Won the Hillsborough County General Civil Service contract for the office. Brought in several FDOT 1 DEMO assignments under prior contracts. Shortlisted on several Districtwide Drainage contracts and invited by FDOT 1 to present for them at the 2007 FICE conference. Project Manager for DOT reconstruction and County intersection improvement projects. Senior Drainage Engineer on multi-lane widening, new construction, and reconstruction highway projects. Engineer of Record for engineering work associated with Water Management District permitting of stormwater management facilities. Responsible for conformance to the FDOT Drainage Design Policy and the State of Florida regulatory standards and statutes. Senior Quality Control and Quality Assurance official for the Tampa Business Unit's Roadway Drainage Design activities. Represent clients at formal and informal Public Meetings.

*Reference: John Darling (Frmr. Office Manager) 813.205.4623*

***American Consulting Engineers of Fla, Inc., Land O' Lakes, FL 4/04 to 7/05***

Senior Drainage Engineer/ Project Manager

Statewide Drainage Engineer for a national transportation engineering firm. Senior Drainage Engineer on multi-lane widening, new construction, and reconstruction highway projects. Engineer of Record for work associated with Water Management Districts. Project Manager for City and County municipal projects with construction costs under one million dollars. Represented clients at formal and informal Public Meetings. Pursued and won several CDD contracts. Considered ownership opportunities until TYLIN approached me with a more affordable stock ownership plan.

*Reference: John Kilgore (Office Manager) 813.927.0061*

***Coastal Engineering, Inc., Brooksville, FL 3/03 to 4/04***

Assistant Director

Assistant Director for a privately owned site and civil engineering firm. Won and closed approximately an average of \$25-50k of contracts per week with private clients during a very "hot" development market. Directed a 15 member technical staff completing residential and commercial construction plans for private developers. Engineer of Record for engineering work associated with Water Management District permitting, DOT Drainage Connection Permits, DOT Driveway Connection Permits, DOT Utility Permits, DOT R/W Permits, and DOT Access Management Connection Permits. Represented clients at Public Meetings.

*Reference: Tom Mountain (Office Manager) 352.796.9423*

***Florida Department of Transportation, Tampa, 9/01 to 3/03***

Assistant District Drainage Engineer

Worked as a Lead Permit Official for D.O.T. Drainage Connection Permit Reviews. Senior Engineer for engineering services completed by the Department for public services. Represented the State at formal and informal Public Meetings. Engineer of Record for engineering work associated with Water Management District permitting of stormwater management facilities.

*Reference: Dwayne Kile (Fmr. Office Manager), 727.572.7111*

***Dames & Moore/ URS, Inc., Tampa, 7/00 to 9/01***

Senior Drainage Engineer

Received an opportunity for a full time position at Dames & Moore. Engineer of Record for Roadway Drainage Engineering services on public transportation projects. Engineer of Record for engineering work associated with Water Management District permitting of stormwater management facilities.

*Reference: Matt Fabrizio (Fmr. Project Manager), 727.423.0202*

***System One - 6/99 to 7/00***

Contract position – Drainage Engineer

Designer and Engineer for roadway drainage consultation on public transportation projects. Designer and coordinator for engineering work associated with Water Management District permitting of stormwater management facilities.

*Reference: Kevin Knudsen (Office Manager), Rob Garrigues (Fmr Supervisor) 813.289.5550*

***Frederic R. Harris, Inc., Philadelphia, PA 8/98 to 6/99***

Civil Designer

Relocated back to Philadelphia to work for a major transportation company. Civil and Transportation Designer for a national transportation and public infrastructure engineering firm. Stormwater Management Design on road widening projects.

*Reference: Timothy Gunner (Former Department Manager)*

***McNally Engineering. Oakland, NJ 4/97 to 8/98***

Project Manager

Brown Caldwell was in the process of acquiring Eckenfelder. Pursued a management opportunity with McNally Engineering for job stability. Managed the design of small site and civil engineering service contracts. Coordinated environmental permits for these activities.

*Reference: Mike McNally, Owner*

***Eckenfelder/ Brown Caldwell, Inc., Ramsey, NJ 8/95 to 4/97***

Project Designer

Civil and Environmental Designer for a waste management division of a national environmental engineering firm. Completed a six month construction quality assurance assignment for a groundwater pump, treat, and reinjection system.

*Reference: Mike Monteleone (Former Office Manager)*



Kevin Singley  
901 E Midway Rd.  
Fort Pierce, FL 34982  
772-618-0449  
[Kevin.singley@yahoo.com](mailto:Kevin.singley@yahoo.com)

### **Building Code Professional**

Accomplished and integrity driven construction professional offering over 30 years' experience as a contractor, inspector, plans examiner, and building official. Recognized as a savvy leader with strengths in construction processes, defining and implementing continuous improvement strategies.

### **JPI Palm Bay/ Fernandina Beach FL/ Okeechobee**

*Plans Examiner/ CBO*

08/2020-Present

Performs remote and in-house multi-trade plans examination.

Performs Temporary CBO coverage for Fernandina Beach and Okeechobee School Board.

03/2018 - 08/2020

### **UNIVERSAL** *Building Inspection department manager*

Managed a department of Threshold Inspectors, Building code Inspectors, Plans examiners, and Building Code administrators. Performed private provider inspections and plan review. Developed relationships with new clients and maintained relationships with existing clients. Supervised business development managers and office staff. Held monthly budget meetings and reported to senior vice president of company.

Safebuilt LLC – South Florida

01/2016 - 03/2018

*Building Official, Plans Examiner, Inspector*

Performed the duties of Building Official, Plans examiner, and Inspector for multiple clients. Most time was spent between our Okeechobee and highland beach accounts but I was sent to dozens of municipalities on temporary a basis and perform all the above duties.

St. Lucie County BOCC – Fort Pierce, FL

06/2015 - 01/2016

*Inspector*

Performed daily inspections

Indian River BOCC – Vero beach, FL

08/2014 - 06/2015

*Inspector*

Performed daily inspections



St. Lucie County School District – Fort Pierce, FL

03/2002 - 08/2014

*Inspector*

Conducted daily Building Code Inspection, Fire inspections, and fire Plan review.  
Also served as the owner's rep, supervising contractors and design professionals

*Licensures and Professional Development*

State of Florida department of business and Professional regulation Certifications:

( ALL Active)

Building Code Administrator

Standard Inspector – Building, Electrical, Mechanical, Plumbing, 1&2 Family Dwelling

Standard Plans examiner – Building, Electrical, Mechanical, Plumbing

State of Florida Fire Marshal Certifications: (not Active)

Fire Inspector I

Fire Plans Examiner

Education

Fort Pierce central High School – 1989 Graduate

U.S. Army Ordnance School – 1991 Graduate

Florida State Fire College – 2004-2008

Military Service

U.S. Army National Guard 1991-1994

Honorable Discharge- Enlistment time served

321.474.7302

Scott.Seigel@ymail.com

### **Areas of Experience**

Building Inspection and Plans Reviewsssss, Building Code, Mechanical Code, HVAC, Energy Savings Performance Contract (ESPC) Project Financial, Development and Implementation Strategies, Commercial, Building Controls and Field Service, Construction Management, Utility Analytics, Facilities Maintenance and Management

### **EDUCATION**

Bachelor of Science, Mechanical Engineering, University of South Florida, Tampa, FL 1994

Master of Business Administration (Executive MBA Program) University of South Florida, Tampa, FL 2018

### **CERTIFICATIONS**

Professional Engineer, Florida #60980; Certified Energy Manager, Association of Energy Engineers;

Commissioning Authority (CxA), AABC; LEED AP, USGBC; OPMP, ASHRAE

### **Experience**

**JPI – Building Inspector / Plans Examiner** 2018-2021

◇ Multi trade building inspector/ Plans Examiner for several governmental agencies in Brevard County including the City of Titusville.

**Technical Expert - Engineering** Siemens Govt Technologies, USA 2013-2018

- Customer Service ranking has improved year over year
- Experience in balancing value propositions across multiple product portfolios
- Mentored small and disadvantaged businesses to help exceed Federal Government SDB expectations
- ◇ Provided technical expertise for Energy Conservation Measures (ECMs)
- Primary analysis included HVAC, Energy Management Control Systems (EMCS), Advanced Lighting Technologies, Cogen and Tri-gen Analysis, Water Reduction Strategies and utility structure analysis'
- Emphasis in renewable energy portfolios: solar, biomass, wind, geothermal, solar thermal, hydro, and ocean technologies.
- Final Determination for bundling of ECMs in an ESPC PA/IGA based on the SPB & finance term
- Development of technical specifications and project schedules based on project requirements as determined by the team

DOD Project Sites: NSGB, USACE, Sigonella, Naples, Rota, Bahrain, Djibouti, CCAD, Var. UMCS Projects

**Sr. Project Manager**, Sain Engineering Associates (SEA), Birmingham, AL 2009-2013

- ◇ Directed Federal Project teams across 13-time zones
- ◇ Directed more than 30 EA and Cx project teams throughout the US, Middle East and Europe encompassing more than 50MMft<sup>2</sup> with projects exceeding \$750MM. (80+ Engineers and Contractors - Direct Reports)
- ◇ Allocated resources based on contract compliance: day to day operations, scheduling, and deliverables
- ◇ Provided technical expertise for Energy Conservation Measures (ECMs)

DOD clients included GSA, US Navy, USACE, USAF, DOE, Army, ANG and Marine Corp

**Sr. Principal Engineer**, Williams-Russell & Johnson Engineers/Architects, Atlanta, GA 2009-2011 (Contract)

- ◇ Designed modified mechanical systems for \$40MM educational facility i.e. Steam, CHW, DX, & CW
- ◇ Responsible Engineer of Record for all Florida projects
- ◇ Managed General and Mechanical Contractors on all required design modifications

**Principal Engineer**, General Physics Corporation, Titusville, FL 2008-2009

- ◇ Led Design Build Team for first major modification of CCAFS/KSC underground Cryogenic gas lines since the Apollo Era
- ◇ Developed new strategic plan which expanded General Physics business development and teaming capabilities

321.474.7302

Scott.Seigel@ymail.com

- Successful JV with 8A Design Firm for City of Orlando engineered design projects (>\$10M)
- Successful JV Teaming for PAFB AFTEC (>\$180M Building)
- ◇ Engineer of Record for shovel ready project modifications across KSC, CCAFS, PAFB and Ascension Island

**Owner/President**, Easley Mechanical Services, Melbourne FL 2003–2008

- ◇ Commercial and Residential HVAC installation
- ◇ Startup company that approached \$2M in revenue after 5 years (16 direct reports)
- ◇ Produced C-Suite analytics monthly, P&L responsibilities
- ◇ Performed all annual performance reviews, hiring, training, and mentoring of Technicians
- ◇ Directed all government and commercial sales efforts
- ◇ Developed a successful inventory control method then managed the SCM processes

**Sr Facilities Engineer**, Siemens Power Corporation, Orlando FL 2000 – 2003

- ◇ Responsible for the design, analysis, and project management of multiple self-determined mechanical and electrical projects in existing office buildings, data centers and laboratories across multiple divisions and 16 buildings (2.4Mft<sup>2</sup>)
- Design Projects: Chiller Plants, Data Centers, Multiple office renovations, exterior renovation(s)
- Major Project: Major HVAC renovation of 260,000ft<sup>2</sup> headquarters building
- Major Project: Construction of (2) 4-story 180,000 ft<sup>2</sup> buildings
- ◇ Specified design criteria, discussed and select minimum equipment requirements with outside equipment manufacturers
- ◇ Produced bid packages which included architectural, mechanical and electrical drawings and specifications
- ◇ Developed strategic plans for mechanical and electrical improvements. Typical facility upgrades included HVAC, temperature controls, electrical, chemical and mechanical equipment, hazmat and fire alarm systems

**Engineering Team Lead** Raytheon Constructor, Cape Canaveral, FL 1999-2000 (Contract)

- ◇ Led Mechanical Department Engineers, Field and Technical Support for the \$250M+ Delta IV Launch Facility (Pad 37B)
- Reduced construction costs by as much as \$25M through correctly interpreting existing plans, design intent and specifications for Cryogenic piping and HVAC systems
- Supervised mechanical, electrical and specialty niche contractors

**Software Expertise**

Analytics: R, Tableau; MS Office: Excel, Word, Project, PowerPoint; Engineering Software: Carrier E-20II, CMMS, Estimation, Tracer, Energy Plus, various load calculation programs

SCOTT ERIC SEIGEL, P.E., LEED AP, C.E.M., CxA, O.P.M.P.  
Melbourne, FL



321.474.7302

Scott.Seigel@ymail.com

**Volunteer Organizational Leadership**

Executive Chairman, American Society of Mechanical Engineers, Cape Canaveral Florida Section 2000-2002

- ◇ Increased revenues 10-fold over a 12-month period
- ◇ Expanded Volunteer Executive Board from 5 members to 33 members; P&L responsibility
- ◇ Government Relations, Woman & Minorities Issues, Professional & Career Development Issues, College Relations, & Member Retention, STEM Teacher Awards, Scholarships, Publicity, and Technical Programs.
- ◇ Awarded 3 consecutive years, 2000-2002, as Best ASME Section Regionally and worldwide 2001, 2002

President, ASHRAE Space Coast Florida Chapter 2009, 2014

ASHRAE Region XII Chair, Government Activities 2014-2015

Military Experience: US NAVY Electrician

**AWARDS**

*Technical Award for Leadership* Canaveral Council of Technical Societies (CCTS)

**Extensive Travel**: 45 states and 41 countries



**SWARR, PETER C., P.E.**  
**Civil Construction Field Engineer**  
**1535 Satinwood Court, NE, Palm Bay, FL 32905**  
**(H)(321) 549-2070 (Cell) (443)-655-4982**

---

## **EDUCATION**

Lehigh University - B.S. Civil Engineering - 1982

## **REGISTRATIONS**

Registered Professional Engineer in Pennsylvania - 2004

Registered Professional Engineer in Delaware - 2004

Registered Professional Engineer in South Carolina- 2009

Registered Professional Engineer in Illinois - 1992

Registered Professional Engineer in Florida - 1991

## **EXPERTISE**

Project Management

Construction Management

Earthwork/Soils Projects

Project Controls – Cost and Schedule

Field Engineering

Owner/Client Relations

## **JPI 2017- CURRENT**

Senior Plans Reviewer and Inspector for multiple trades (building, mechanical, plumbing, and electrical trades). Utilizes tablet to enter field results in real time. Primarily work in St.Lucie County.

## **SARGENT & LUNDY RESPONSIBILITIES**

Mr. Swarr provides construction management leadership and support to Clients assisting them accomplish their project specific scope, schedule, cost, and quality objectives. During the pre-construction phase, his responsibilities include pre-construction planning, project scope development, budget and schedule preparation, bid preparation and award, and performing constructability reviews. In the construction execution phase, he monitors contractor work activities, verifies contractor schedule and work quality, assists in resolving design and installation questions, and administers construction contracts. He has capabilities to lead project teams or perform critical individual contributor role duties. He is a proficient verbal and written communicator.

## **EXPERIENCE**

- **NIPSCo – Reynolds**



**SWARR, PETER C., P.E.**  
**Civil Construction Field Engineer**  
**1535 Satinwood Court, NE, Palm Bay, FL 32905**  
**(H)(321) 549-2070 (Cell) (443)-655-4982**

---

Assigned as a field construction engineer for the Reynolds substation and the Reynolds IN to Topeka, IN transmission line. Duties include management of construction activities, overseeing foundation installation, overseeing the delivery of transformers for the project, overseeing the installation of caissons for the substation components, and overseeing clearing of the right of way. (2015 to present)

- **Duke Energy – Oconee Nuclear Power Station**

Civil Construction Field Engineer. Assigned to the Tornado/HELP and Protected Service Water Project as a Construction Implementation Engineer. During the design process, responsibilities were to provide concrete and structural-related constructability input and analysis to the Engineering Group for specific modifications. During the concrete and structural installation work, supported the Contractors leading activity to resolve Contractor field problems and initiating actions to remove barriers to Contractor installation success. (2009 to 2012). Recalled to site to expedite the drawing as-building process and to facilitate the installation of the PSW pump and associated piping system. In addition, designed various hangers required due to relocated equipment. (2013 to 2015)

- **Basin Electric Power Cooperative – Laramie River Station**

Civil Construction Field Engineer. Assigned to the Circulating Water Piping Refurbishment Project. Duties were to conduct oversight and inspections of contractor CW piping refurbishment work during the plant outage. Refurbishment work consisted of cleaning, preparation, and coating internal CW piping surfaces. During the work, prepared inspection and progress reports. (2013)

- **OPPD – Fort Calhoun Nuclear Station**

Civil Construction Field Engineer. Assigned to the Containment Internal Structures Project. Duties were to implement a concrete and structural inspection and testing program for reinforcement of reactor containment internal structures. (2013)

- **ECS Mid-Atlantic**

Senior Project Engineer. Responsible for preparation of subsurface investigations; providing design recommendations for building foundations; assessment of subsurface data from field investigations; and training of geotechnical inspection personnel. Performed third-party construction inspections including civil, structural, mechanical, electrical, plumbing, insulation, and fire protection for various projects. Supervised field technicians performing soils, concrete, and structural steel inspections. Provided construction advice to clients as to methods to solve their construction problems, such as would be encountered in utility, roadway, or building installation. Performance of property condition assessments, environmental site assessments, and asbestos surveys. Projects included deep foundations for buildings, earthwork projects, residential subdivisions, subdivision roadways, commercial facilities, and industrial facilities in the Delaware, Southeastern Pennsylvania, and Northeastern Maryland region. (2003 to 2008)

- **ASC Geosciences**

Senior Project Engineer. Responsible for preparation of subsurface investigations; providing design recommendations for building foundations; assessment of subsurface data from field investigations; and training of geotechnical inspection personnel. Supervised field

**SWARR, PETER C., P.E.**  
**Civil Construction Field Engineer**  
**1535 Satinwood Court, NE, Palm Bay, FL 32905**  
**(H)(321) 549-2070 (Cell) (443)-655-4982**

---

technicians performing soil, concrete, structural steel, masonry, and other special inspections. In addition, advised contractors as to methods to solve their geotechnical construction problems, such as would be encountered in utility, roadway, or building installation. Performance of environmental site assessments and asbestos surveys. Projects included deep foundations for buildings, residential subdivisions, subdivision roadways, and commercial facilities in the State of Florida. (2003)

- **Law & Associates**

Senior Project Engineer. Responsible for preparation of subsurface investigations; providing design recommendations for building foundations, assessment of subsurface data from field investigations, and management and training of soils, concrete, structural steel, and masonry inspection personnel. (2001 to 2002)

- **HSA Engineers and Scientists**

Senior Project Engineer. Responsible for preparation of subsurface investigations, providing recommendations for foundation design; assessment of subsurface data from field investigations; and management and training of geotechnical inspection personnel. (2000 to 2001)

- **Atlantic Testing Laboratories**

Vice President and Chief Engineer. Responsible for preparation of subsurface investigations; providing recommendations for foundation design; assessment of subsurface data from field investigations; and management and training of soils, concrete, structural steel, and masonry inspection personnel. (1993 to 2000)

- **GSC Environmental Laboratories, Inc.**

Senior Project Manager/Engineer/Asbestos Consultant. Responsibilities included: supervision of field personnel; marketing; performance of environmental assessments; technical reviews, conduction various other inspections and tests, management of field technicians. (1991 to 1993)

Project Manager. Responsible for preparation of subsurface investigations; providing recommendations for foundation design, assessment of subsurface data from field investigations, and management and training of geotechnical inspection personnel. (1989 to 1991)

- **Frederick Ward Associates**

Project Manager. Responsible for establishment of a geotechnical department; interface with clients (including contractors, governmental agencies, etc.); geotechnical recommendations; report preparation/review; training and supervising of lab and field inspectors. (1987 to 1989)

- **Robert B. Baiter Company**

Project Engineer and Inspector. Responsible for performance of inspections and tests for construction materials including soils, concrete, and structural steel; providing recommendations for shallow and deep foundation systems, and report preparation. (1985 to 1987)

**SWARR, PETER C., P.E.**  
**Civil Construction Field Engineer**  
**1535 Satinwood Court, NE, Palm Bay, FL 32905**  
**(H)(321) 549-2070 (Cell) (443)-655-4982**

---

### **SPECIFIC PROJECT EXPERIENCE**

Westbridge Apartments, Annapolis, MD - Senior Project Manager and construction inspector.

The Crescent at Fells Point, Baltimore, MD - Senior Project engineer and construction inspector

Domain Brewers Hill, Baltimore, MD - Senior Project engineer and construction inspector.

Annapolis Junction Commercial Park, MD - Senior Project engineer for inspection agency.

Wickham Road widening, Brevard County, FL - Engineer for inspection agency Dairy Road

widening, Brevard County, FL - Engineer for inspection agency.

Kennedy Space Center, several projects, including Launch Pads 39 B (Shuttle) and 41 (Titan) - Geotechnical engineer and Engineer for inspection agency.

Walt Disney World, Emergency Services Facility - Geotechnical Engineer.

Walt Disney World, Buena Vista Drive Re-Paving- Engineer for testing agency.

Emerald Isles Condominiums, Panama City, FL - 23 Stories, Geotechnical Engineer, pile inspection, threshold construction inspections.

City of Palm Bay, FL - Geotechnical engineer for roadway re-construction/upgrades City of

Melbourne, FL - Geotechnical engineer for roadway re-construction/upgrades.



# ANDREW THOMAS MANERO

1113 Blossom Drive Sebastian, FL 32958

ph 561 901 3513, email: atmanero@gmail.com

## OBJECTIVE

---

Collaborate with a team to promote Education & Awareness through the built environment.

## CERTIFICATIONS

---

**Registered Architect, AR96338**

**Interior Designer, ID6107**

**LEED BD+C**

## EXPERIENCE

---

**JPI- JOE PAYNE INC.**, Plans Reviewer/ Building Inspector, August 2017-Present

**Residential & Commercial Building Plans Reviewer (In-House) and Building Inspector**

In-house Plans Reviewer for St. Lucie County and a Treasure Coast Municipality. Commercial plans examiner for JPI for projects multi-story commercial projects and other forms of commercial projects. Review Permit Documents, Permit Applications, & Notice of Commencement on site. Apply knowledge of Building Code in field to built conditions. Verify construction is compliant with Project Documents and Building Code

**UMBER ARCHITECTURE LLC**, President, 2013-Present

**Residential & Commercial Project Architect**

Prepare Construction Documents for Submission to Authority Having Jurisdiction

Review Plans submitted by Engineers, Consultants and Contractors

Meet with Building Official and Plan Reviewer's to walk-through Complex projects

Verify project is in compliance with the Construction Documents during Construction **Projects:**

**Stratford Arms-** 10,000 square foot Condominium Communal Area Renovation, Boca Raton, FL

**Pure Vie-** 1,500 Square Foot Spa & Yoga Studio Build-Out, Sarasota, FL

**Bowen Residence-** New 5,000 Square Foot House in Lighthouse Point, FL

**Kathy's House-** New 3,200 Square Foot House in Delray Beach, FL

**Cohen Residence-** 4,000 Square Foot Condominium Renovation in Boca Raton, FL

**Kukes Residence-** 5,300 Square Foot Condominium Renovation in Boca Raton, FL

**Convissar Residence-** Residential Addition

**Swanson Residence-** Residential Site Plan

**Equestrian Way-** Residential Remodel & Addition

**LEIGHTON DESIGN GROUP**, 2013-Present

**Residential & Commercial Interior Design**

**Reviewed Plans and Construction Documents for ADA and Building Code Compliance.** Project Management, Project Design, Drafting, Scheduling, Construction Administration. Review General Contractor's Bids, for completeness.

**ANDREW T MANERO, ARCHITECT, Owner, 2012-2013**

***Residential & Commercial Architecture***

**Lupa Shoes-** Retail renovation & re-branding

Programming: Analyzed display & storage requirements, created options for new store image

Design Development: Created new floor plan, lighting layout, and display systems within budget

Construction documents: Prepared bid documents, & permit sets

**Ortega Lane-** High-end residential design/build

Reviewed design concepts with owner & implemented into working drawings

Interviewed contractors, reviewed qualifications & bids

Created construction documents for city

Supervised construction, motivated contractors to meet deadlines

**RENEWABLE LIVING INC, General Manager, 2011-2013**

***High End Interior Design/Build, Custom Fabrication & Installation***

Manage general operations, systemization, finances, payroll, and insurance, create marketing material

**Generate leads,** convert to sale, and close deals

Estimate project costs, negotiate buy-outs, purchase materials, and coordinate installations

Supervise the design & construction teams

**WEST ARCHITECTURE, Project Manager, 2010**

***Architecture & Construction***

Met project budget and time schedule

Managed Construction Documents, Engineer Coordination, & Estimating.

**Design/Build:** Plan & implement fluidity of drawings for construction to minimize changes.

**Historic Renovations:** Synchronized notes on drawings to accommodate Historic Society &, Archeological requirements with modern construction methods.

Created marketing packages for RFP's

**BALFOORT FINNVOLD ARCHITECTURE, Project Manager, 2007-2010**

***Architecture***

Coordinated construction documents with owner, consultants, & city reviewers

**LEED Projects:** Documented and managed LEED Templates

Estimated and analyzed costs of materials, systems and finishes

Edited and assembled the Project Manual and Specifications

**Custom Homes:** Met with homeowners to, present select finishes and approve drawings, make sure the homeowner understood the drawings and was always satisfied

Created and presented 3d walkthroughs with selected finishes to homeowners

Completed projects on schedule in accordance with Housing Department requirements and secure permit from the Building Department

**Contract Administration:** Lead pre-bid & pre-construction meetings, observed job sites during construction administration, and approved pay applications

Addressed and problem solved building issues during construction

**GLAVOVIC STUDIO INC, Project Manager, 2005-2006**

***Architecture, Urban Planning***

**Site Feasibility Report for Miami Beach:** Systematically investigated site conditions, and current user groups

Developed conceptual design based on City Master Plan

Investigated precedents and interviewed potential users for a skate plaza

Compiled findings into a final document and Power Point presentation  
Client extended contract for further consideration of project

### **ARCHITECTURAL DIMENSIONS**, Drafter, 2004-2005

#### ***Architecture***

**Retail Stores:** Gap Inc/ Old Navy/ Banana Republic

Worked with the project team to complete construction documents.

Administered quality control for drafting team.

### **ARCHITECTURAL INTERIORS OF SOUTH FLORIDA**, Designer/ Drafter, 2001-2003

#### ***Interior Design***

The Village of Merrick Park, Motorola, ATI Technical School

As build drawings, Construction Documents, Rendering.

### **ACADEMICS**

---

Florida Atlantic University, Bachelor of Architecture 2006

### **SKILLS**

---

Accela Inspector

Masterspec software

Sketchup, Realistic Renderings

Auto CAD 2D and 3D

Adobe: Photoshop, Illustrator, In Design, Acrobat

Microsoft: Word, PowerPoint, Moviemaker, Outlook, Excel

QuickBooks



## GENERAL INFORMATION

JPI has vast experience with plan review of applications within tourism areas. This primarily comes from our vast clientele in St. Lucie County and coastal areas through Florida. We find that key factors in plan review for visitor tourism and marketing are as follows:

- 1) Historic Preservation
- 2) Signage
- 3) Accessibility
- 4) Review schedules

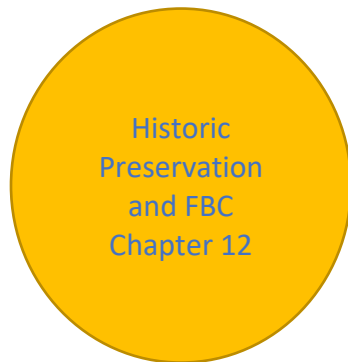

Historic Preservation is a key building code activity for tourism in Florida. Our tourism quite often features Historic buildings which are popular for local tourism and out of town tourism. Preservation supports federal funding also for the project to maintain the building in its historic state. FBC Chapter 12 provides Code on Historic Buildings. The intent is to provide means for occupant safety, property conservation and use of designated historic buildings while protecting those elements, spaces and features that make these buildings historically or architecturally significant.

Signage beautifies tourism areas and provides marketing platforms for communities. Appendix H Signs of the Florida Building Code provides Code on the erection of signs. Chapter 31 discusses special construction. Other sections also discuss signage. NEC 2017 provides lighting Code for signage.

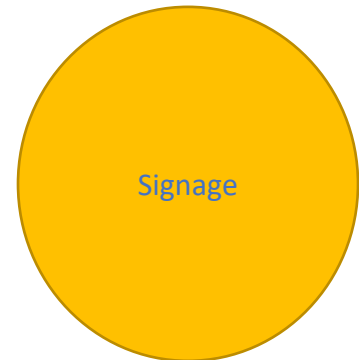

One key factor of the Building Code which affects marketing and tourism is accessibility. JPI completes a thorough accessibility review of sidewalks, access, corridor widths and lobbies of common areas. Tourism and marketing projects provide future tax revenues, so with cash flow, always comes the importance of schedule, specifically plan review schedules. These projects may receive priority plan reviews due to the stakeholders involved in the community.

JPI completed plan reviews on a variety of projects over the years with our clientele involving marketing and tourism. Here are three examples:



- 1) St. Lucie County. St Lucie County has an Office of Tourism which we interface with on key projects. One example, is that JPI has completed plan reviews and other professional services at hangers within the Treasure Coast International Airport.
- 2) Clearwater, FL. JPI has completed plan reviews and inspections for a variety of new high-rise hotels in Clearwater and Clearwater Beach, FL. The most recent project is the Alanik Hotel in Clearwater Beach, FL which broke ground in 2023.
- 3) Fernandina Beach. Fernandina Beach Main Street is regulated by the National Trust for Historic Preservation. Demolition within most commercial building in this area is limited to what is allowable the Preservation. These restrictions far surpass the Building Codes for certain work, as Preservation is the key goal.





## CERTIFICATES

JPI provides DBPR and sunbiz.org certificates. Also, we provide a summary table of our employee licensure.

<u>JPI</u>	<u>DBPR</u>	<u>Years Exp</u>
Joe Payne	FLPE55751	30
Greg Perlin	BN6576	40
Jack McCabe	BN4613	50
Jason Steele	FLPE69234	20
Cory Brockett	FLPE74677	20
Bob Hightower	BN2430	40
Doug Walton	AR0007045	50
Andrew Chupka	FLPE46655	40
Juan Mastrapa	FLPE68217	30
Greg Martin	BN3947, PX1848	40
John Wiggins	BN2384	40
Andrew Mareno	AR96338	20
Eddie Page	FLPE69045	30
Pete Swarr	FLPE44159	40
Ezz Elgayar	BN6415	40
Robert Bryce	PX2783	45
Scott Seigel	FLPE60980	30
Luke Curtis	RPX279, PX3717, BN6614, BU1975	30
Andrew West	FLPE60301	30
Dan Folwell	BN6927	40
Charles M. Nolan	FLPE19889	45
Rick Hoepner	FLPE23319	50
Ryan Ferry	BN6617	15
Mark Thornbloom	FLPE50107	35
Jon Thomas	BN7125	15
Glenn Hall	PX3588, BN5324	50
Kevin Singley	PX3601, BN4798, BU1872	30
Micheal Tew	PX2675, BN5003	30
Tony Murphy	AR100424	35
Robert Peck	BN7567	40
James Crouch	BN8698	40



[Department of State](#) / [Division of Corporations](#) / [Search Records](#) / [Search by Entity Name](#) /

## Detail by Entity Name

Florida Profit Corporation  
JOE PAYNE, INC.

### Filing Information

**Document Number** P10000059808  
**FEI/EIN Number** 80-0640420  
**Date Filed** 07/21/2010  
**State** FL  
**Status** ACTIVE

### Principal Address

5995 S HIGHWAY A1A  
MELBOURNE BEACH, FL 32951

Changed: 06/28/2021

### Mailing Address

5995 S HIGHWAY A1A  
MELBOURNE BEACH, FL 32951

Changed: 02/09/2022

### Registered Agent Name & Address

PAYNE, JOSEPH  
5995 S Highway A1a  
MELBOURNE BEACH, FL 32951

Address Changed: 01/23/2022

### Officer/Director Detail

#### **Name & Address**

Title DPST

PAYNE, JOSEPH  
5995 S Highway A1a  
MELBOURNE BEACH, FL 32951

### Annual Reports

<b>Report Year</b>	<b>Filed Date</b>
2021	01/11/2021

2022                    01/23/2022  
2023                    01/19/2023

**Document Images**

<a href="#"><u>01/19/2023 -- ANNUAL REPORT</u></a>	View image in PDF format
<a href="#"><u>01/23/2022 -- ANNUAL REPORT</u></a>	View image in PDF format
<a href="#"><u>01/11/2021 -- ANNUAL REPORT</u></a>	View image in PDF format
<a href="#"><u>01/28/2020 -- ANNUAL REPORT</u></a>	View image in PDF format
<a href="#"><u>02/14/2019 -- ANNUAL REPORT</u></a>	View image in PDF format
<a href="#"><u>01/21/2018 -- ANNUAL REPORT</u></a>	View image in PDF format
<a href="#"><u>01/10/2017 -- ANNUAL REPORT</u></a>	View image in PDF format
<a href="#"><u>07/07/2016 -- ANNUAL REPORT</u></a>	View image in PDF format
<a href="#"><u>01/20/2015 -- ANNUAL REPORT</u></a>	View image in PDF format
<a href="#"><u>04/19/2014 -- ANNUAL REPORT</u></a>	View image in PDF format
<a href="#"><u>04/27/2013 -- ANNUAL REPORT</u></a>	View image in PDF format
<a href="#"><u>04/12/2012 -- ANNUAL REPORT</u></a>	View image in PDF format
<a href="#"><u>04/11/2011 -- ANNUAL REPORT</u></a>	View image in PDF format
<a href="#"><u>07/21/2010 -- Domestic Profit</u></a>	View image in PDF format

THE OFFICIAL SITE OF THE FLORIDA DEPARTMENT OF BUSINESS & PROFESSIONAL REGULATION



Florida **dbpr** Department of Business & Professional Regulation

[HOME](#) [CONTACT US](#) [MY ACCOUNT](#)

**ONLINE SERVICES**

- [Apply for a License](#)
- [Verify a Licensee](#)
- [View Food & Lodging Inspections](#)
- [File a Complaint](#)
- [Continuing Education Course Search](#)
- [View Application Status](#)
- [Find Exam Information](#)
- [Unlicensed Activity Search](#)
- [AB&T Delinquent Invoice & Activity List Search](#)

**LICENSEE DETAILS**

11:50:56 AM 6/1/2023

**Licensee Information**

Name:	<b>JOE PAYNE, INC. (Primary Name)</b>
Main Address:	<b>5995 S HIGHWAY A1A MELBOURNE BEACH Florida 32951</b>
County:	<b>BREVARD</b>

**License Information**

License Type:	<b>Engineering Business Registry</b>
Rank:	<b>Registry</b>
License Number:	<b>29882</b>
Status:	<b>Current</b>
Licensure Date:	<b>04/24/2012</b>
Expires:	

**Special Qualifications**                      **Qualification Effective**

--

**Alternate Names**

--

- [View Related License Information](#)
- [View License Complaint](#)

---

2601 Blair Stone Road, Tallahassee FL 32399 :: Email: **Customer Contact Center** :: Customer Contact Center: 850.487.1395

The State of Florida is an AA/EEO employer. **Copyright 2007-2010 State of Florida. Privacy Statement**

Under Florida law, email addresses are public records. If you do not want your email address released in response to a public-records request, do not send electronic mail to this entity. Instead, contact the office by phone or by traditional mail. If you have any questions, please contact 850.487.1395. \*Pursuant to Section 455.275(1), Florida Statutes, effective October 1, 2012, licensees licensed under Chapter 455, F.S. must provide the Department with an email address if they have one. The emails provided may be used for official communication with the licensee. However email addresses are public record. If you do not wish to supply a personal address, please provide the Department with an email address which can be made available to the public. Please see our **Chapter 455** page to determine if you are affected by this change.



[Previous on List](#) . [Next on List](#) . [Return to List](#)

Fictitious Name Search

[Filing History](#)

Submit

## Fictitious Name Detail

### Fictitious Name

JPI

### Filing Information

**Registration Number** G15000008007  
**Status** ACTIVE  
**Filed Date** 01/23/2015  
**Expiration Date** 12/31/2025  
**Current Owners** 1  
**County** HILLSBOROUGH  
**Total Pages** 4  
**Events Filed** 3  
**FEI/EIN Number** 80-0640420

### Mailing Address

5995 S HIGHWAY ALA  
 MELBOURNE BEACH, FL 32951

### Owner Information

JOE PAYNE, INC.  
 5995 S HIGHWAY ALA  
 MELBOURNE BEACH, FL 32951  
**FEI/EIN Number:** 80-0640420  
**Document Number:** P10000059808

### Document Images

[01/23/2015 -- REGISTRATION](#)

View image in PDF format

[02/07/2022 -- CHANGE NAME/ADDRESS](#)

View image in PDF format

[05/27/2021 -- CHANGE NAME/ADDRESS](#)

View image in PDF format

[01/12/2020 -- Fictitious Name Renewal Filing](#)

View image in PDF format

[Previous on List](#) . [Next on List](#) . [Return to List](#)

Fictitious Name Search

[Filing History](#)

Submit



## **FINANCIAL DATA**

JPI's Dunn and Bradstreet number is 039948949. If necessary, we will submit our 1120 tax forms as proprietary during the selection process.



## SCOPE OF WORK

Our Approach to the Scope of Work is based on our sound knowledge of Building Code Review from our statewide contracts. There are several key factors of measurement for the success of the Approach to the Scope of Work. From our experience, JPI found that the citizen and contractor end user's needs are best met through four key factors:

- 1) Current knowledge
- 2) Consistency
- 3) Code references
- 4) Quality Control

### 4 KEY FACTORS

Current knowledge  
Consistency  
Code references  
Quality Control

JPI is the sole source vendor for the St. Lucie County Building and Code Regulation

Current knowledge is a key factor for this work. JPI possesses technical staff who are subject matter experts in plan review. Through our current work with plan review, JPI maintains knowledge of Technical Bulletins, Code Advisories, and Code Updates. JPI possesses this knowledge in both residential and commercial construction and in all trades. From feedback that we receive from our current clientele, our commercial plan review is very thorough with code references and cross reference to NFPA and other codes. JPI has

worked with St. Lucie County since 2018 and is familiar with how to interact with the local builder community.

The second key factor is Consistency. Specifically, with the Pass/Fail rate of our work for statistical significance to the City employees. This establishes consistency between resources and provides consistency to the citizens of Fort Pierce. The contractor community is sensitive to a new plan reviewer creating review comments unseen regularly in the community. JPI proposes to initially contact the Building Division with our proposed comments prior to posting to the applicant. JPI possesses several standard comment files, with code references, that we can share with the Building Division.



**Click2Gov**

JPI possesses permitting software knowledge through our past and current work. We are familiar with the main screen which lists the active reviews in que. As an on-call provider, JPI provided professional services for all trades including electrical, mechanical, building, and plumbing trade professionals. JPI is different from our competitors because of our availability of multi-trade staff and the personal touch of the Owner, Mr. Payne, who will leave the office and assist clients with plan review services. **Mr. Payne regularly reviews plans for Mr. McCloud.** JPI is a 100% Florida Based company with 100% of our employees residing and working in Florida.

Our notice period to provide staffing ranges from **five minutes** to five days. When the City provides five days of notice, JPI will typically serve these requests 100 percent of the time. When the City provides 24 hours of notice, JPI will typically serve these requests 90 percent of the time. When the City calls us in the morning of the day requiring plan review, we still can meet this request with a 50 percent reliability, by having local staff and the ability of the Owner Mr. Payne, to leave the office and service contracts “hands-on”.

JPI will provide all equipment necessary for this work and has done so as an incumbent. JPI employees maintain FBC, NEC, NFPA, ICC and other related code references as they complete their work. For plan review, 30 full-time equivalents, FTE’s, can perform plan review with at least 10 FTEs per trade available (due to multi-trade licensure). JPI has four licensed building officials available for this contract and twenty licensed professional engineers.



**The third key factor is Code References.** JPI proposes a **WORK Plan** unique to the services listed within this RFP. Our **WORK Plan** will consider all regulatory Codes for this Work Objective. The 2020 FBC, Mechanical, 7<sup>th</sup> edition will regulate policy for HVAC systems. The 2010 ADA will regulate the ADA inspections along with Accessibility Code. The 2020 FBC including the Existing Conditions Chapter, will regulate building code compliance, doors and hardware, fences, structural aspects of Fireplaces & Chimney, Insulation, Roofing Systems, Seawalls, Docks,

and Structural Components. Florida Elevator Code Authority and FBC Chapter 30 (over three stories) regulates elevators. NFPA 70 regulates fire protection and co-regulated NEC 2017 and 2020. ASCE 7-16 regulates wind loads. The Energy Code is an overlapping regulation. Solar Energy Code is regulated in several locations including Chapter 23 of the Residential Code and Chapter 14 of the Mechanical Code, and the Florida Plumbing Code. FBC Chapters 4 and 45 regulate swimming pools and saunas. The Florida Plumbing Code regulates plumbing systems, plumbing and pool heaters, and the Gas

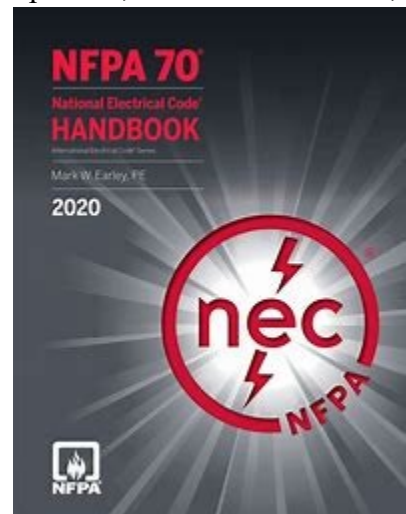





Code regulates gas pool heaters. Additional Code considerations within our Operational Plan include NFIP, NPDES, ACOE, FAA47CFR, and [FAA107 for the developing Drone technologies for roof inspections.](#)

Continuing with this **WORK Plan**, JPI will input the daily plan review results in a timely fashion. JPI professionals will utilize individual emails and direct phone numbers to communicate with City constituents. JPI has multi-trade professionals who will review and process construction plans for issuance of building permits under the Florida Building Code. JPI will enforce other agency submittals including FEMA, Driveway permit, and FDEP. JPI will maintain records of work conveniently through creating a pdf of the results. JPI will enforce the 50/50 rule for substantial improvements for FEMA on projects and review and maintain all records required by Federal Emergency Management Agency (“FEMA”) in association with the processing of building permits in the format required by FEMA. JPI will maintain all records and documents in accordance with Public Records Law (Chapter 119, Florida Statutes) and using the current General Records Schedule GS1-SL (For State and Local Government Agencies) which includes the GS6 (For Building Departments). This expands to include code enforcement of hazards, nuisances, and violations. JPI’s multi-trade professionals and licensed engineers will assist in the preparation of the Insurance Services Office (ISO) evaluation for the City.

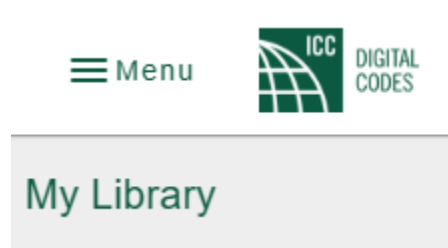

JPI Professionals possess OSHA Level D attire with JPI logo shirts. In the office, JPI professionals will dress in business casual with JPI logo shirts. JPI personnel have smart phones with mobile hotspots and Bluetooth for ease of Wi-Fi and platform access. In addition, JPI personnel utilize Ipads which contain training and continuing education software. All JPI Building Code Professionals receive

continuing education for license renewals. Engineers receive continuing education bi-annually for license renewals as do Registered Architects. JPI has a digital subscription to the ICC digital library and as continuing education all employees reference a digital subscription of the Florida Building Code in their practice along with the use of ICC code check books.

JPI will initially utilize staff already located locally. Joe Payne is the Project Manager. JPI is a statewide firm staffed with a TEAM ORGANIZATION of 40 professionals. Our company’s operational capacity is 1800 hours per week. Currently, we are running at approximately 1400 hours per week billable which is our current and projected workload. We have up to 400 hours per week of surplus capacity available to service this contract. This is approximately ten full-time equivalents. We are operating at 77.78% capacity with 22.22% availability to support our WORK PLAN.

JPI’s **EXPERIENCE** includes successful and practical work on similar projects. JPI currently serves numerous similar agencies including St. Lucie County, Martin County, Brevard County,



City of Stuart, and previously, Indian River County. JPI has a proven track record of excellent customer service, and the City may contact any of our references to verify the same. JPI will perform the duties of the Plan Examiner to accept and review plans, issue permits, perform inspections, issue certificates of occupancy and perform other Florida Building Code and City Code duties.

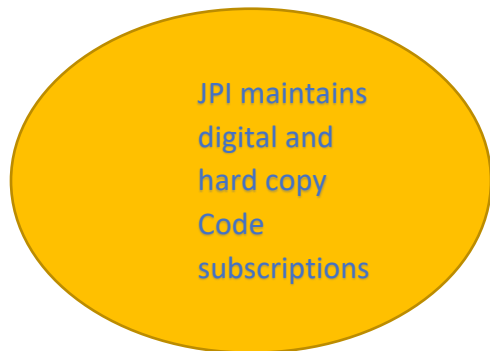

JPI has a full access digital subscription to the ICC website which provides digital access to current and prior editions of the Florida Building Code. In addition, our staff possesses handbooks on tablets and smartphones (with mobile hotspots) which provide convenient access to Code references. The **TEAM MANAGEMENT** of JPI includes a quality control program for new contracts, and staff, which includes mentoring and shadow/ over the shoulder training. Joe Payne, PE is the **TEAM PROJECT MANAGER** and **regularly monitors the**

**pass/fail rate of our inspections.**

The SDE is a tool to help local officials administer the Substantial Damage requirements of their floodplain management ordinances in keeping with the minimum requirements of the NFIP.

FEMA is a key plan review and inspection subject matter that interfaces with ROW, Zoning, Site, Habitat, Environmental, and all services under this RFP. The monitoring of FEMA substantial improvements is imperative. Key activities fall under Flood Damage Reduction, however, also consider public information (elevation certificates). The Zoning activities under this RFP dovetail into Mapping and Regulations and Flood Damage Reduction. This contract supports Warning and Response activities by filing in for City operations during Emergency Management situations such as named Hurricane Storms. Public Information Activities mainly consist of elevation certificates. This begins at the plan review level when the reviewer checks for the FEMA base flood elevation and design flood elevation. FEMA Technical Bulletin 10-01, page 7, Figure 2 is a key

resource when reviewing foundation construction in the floodplain.

The City floodplain manager provides Map Information Services and Hazard Disclosures to the Community. We presume that under this current RFP, that JPI will interface with hazard disclosures through the ROW field investigation work. JPI will utilize available City GIS system data for Flood Protection Assistance and Flood Insurance Promotion. The Zoning and Habitat service under this contract will support Mapping and Regulations. Habitat supports Open Space Preservation.



The goal of these efforts is to develop into Flood Damage Reduction. Floodplain Management Planning is a goal of the Zoning reviews. The ROW services under this contract will support Acquisition and Relocation services. Flood proofing is a concept regulated in efforts to provide flood protection. Flood vents, flood proofing materials below the Design Flood Elevation, raising electrical panels to elevations above the DFE, are all examples of Flood Protection activities. Site Inspections will support Drainage System Maintenance. Our services provide support to the City for Warning and Response activities. When City employees need to enter communities to complete damage assessment, for example, JPI staff backfill the Division and complete their inspection and plans examination for that period of time.

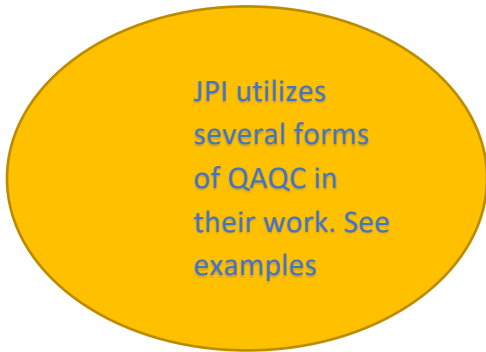

**A fourth key measuring factor for this work is Quality Control.** JPI's Quality Control process starts with Day 1 for the employee. JPI has a shadowing program, and employees have over the shoulder shadow training for the first two weeks. This is a progressive training approach in which the over the shoulder time decreases daily over the two weeks. Also, we conduct audits of work for employees and randomly have shadow oversight. The employee is informed in the morning that JPI will oversee their work that day. For plan review and

office work, JPI completes work from Code Review checklists. JPI feels that it is best to depict checklists used for our work to emphasize that work. The following are examples of Quality Control processes and procedures utilized for work under this contract.



Date: \_\_\_/\_\_\_/\_\_\_

Permit Number: \_\_\_\_\_

**2020 Plan Review Guideline (SFR)**  
Based on Florida Building Code 7th Edition (2020)

Living SF: \_\_\_\_\_ Non-Living SF: \_\_\_\_\_ Total SF: \_\_\_\_\_ Bedrooms: \_\_\_\_\_ Bathrooms: \_\_\_\_\_ Stories: \_\_\_\_\_  
Insulation/efficiency: \_\_\_\_\_ Heat: \_\_\_\_\_ Roof: \_\_\_\_\_  Porch  Gas

- Consistent square footage calculations on construction plans and zoning permit FBC 107.2.6
- Consistent approved plot plan and construction plans FBC 107.2.6
- FL product approval sheet for all exterior materials FBC 107.2.4
- Energy calculations FBC EC R101.5
- Form 405-2020
  - Signed by preparer and owner/agent
  - Has pass seal
  - Conditioned floor are matches living area on plans
  - Attic Vented  Attic Unvented
  - Insulation matches wall sections on construction plans
  - Water heater  (Gas)  (Electric)
- Manual J FBC EC R403.7
  - Consistent with Manual S
  - Equipment information notated
- Manual S FBC EC R403.7
  - Total capacity equal to or greater than 100% and less than or equal to 115% (or closest available unit size)
- Duct layout FBC EC R403
  - Consistent with construction plans (flipped ducts layouts are unacceptable)
  - Duct sizes, CPM, and return/supply Or
  - Manual D

- General Construction Plan Requirements**
- Paper Plans FAC 61G15-23, 61G1-16
    - Original hand signature and wet or raised seal from a licensed Florida design professional
  - Digital Plans FAC 61G15-23, 61G1-16
    - Unlocked digital signature capable of verification and a seal from a licensed Florida design professional on the first page
  - Plans dimensioned and scaled
  - Plans legible (minimum text size 3/32") LCC Ch.6
  - Plans designed to the 2020 Florida Building Code Residential and all other applicable codes

- Structural**
- Wind zone location or wind speed FBC R301.2.1
  - Exposure category FBC R301.2.1.4
  - Design loads FBC R301
  - Components and cladding pressures for openings FBC R609.2
  - Lumber grade and species FBC R502, 602, and 802
  - Fasteners used with P.T. wood FBC R317.3
  - Lintel designation FBC R608.8.2

- Foundation Plan**
- Slab description (thickness and compressive strength) FBC R402.2 and 506
  - Minimum 6-mil polyethylene or approved vapor retarder FBC 506.2.3
  - Soil bearing value FBC R401.4
  - Termite treatment FBC R318
  - Sloped garage floors to main door FBC R309.1
  - Footing dimensions and location FBC R309.1
  - Footing minimum 12" below grade FBC R403.1.4
  - Isolated/Column footing dimensions and location
  - Stem/retaining wall height

- Floor Plan**
- Square foot tabulation (living/nonliving)
  - 1 exterior swing door to be minimum 3'x6'-8" FBC R311.2
  - Hazardous glass locations indicated as "Temp." or "Safety" (Within 2' of doors, bath or pool areas within 5' with a sill below 5", stairs with sill below 3", within 5' of bottom of stairs with sill below 3') FBC R308.4
  - Solid or 20 min fire rated door from garage to dwelling FBC R302.5.1
  - 1/2" gypsum or better on garage wall side of dwelling separation FBC R302.6
  - 5/8" type x gypsum on garage ceiling if habitable room above FBC Table R302.6
  - 1 bath/toilet room with a 29" minimum clear access, on the lower floor FBC R320
  - Sleeping rooms have E.E.R.O/Egress Opening FBC R310.2
  - Attic access location (minimum 22x30 and all separate areas with 30" height clearance) FBC R807
  - Hallways minimum 3' wide FBC R311.6
  - Rooms labeled and uses identified

- Elevation Plan**
- All elevations
    - Dimensioned
  - Windowsills minimum height FBC R312.2.1
  - Roof vent calculations if required on Form 405-2020 FBC R806
  - Crawlspace ventilation and access (if applicable) FBC R408
  - Roof slope FBC R905
  - Roof material FBC R904
  - Location of vented appliance/fireplace (if applicable) FBC R G2427
  - Egress windowsills maximum height FBC R310.2.2

- Truss Plan**
- Signed and sealed by design professional of record FBC R802.10
  - Strapping locations FBC 107
  - Truss bracing FBC R802.10.3
  - Connector chart specifying the type, size, and number of fasteners FBC 107
  - Gable end details (if applicable) FBC R602
  - Truss plans consistent with elevations FBC 107

- Electric Plan**
- Electric layout FBC 107 per NEC 2017
  - Smoke alarms FBC R314
    - In each sleeping area
    - Outside each sleeping area
    - On each dwelling floor
  - Carbon monoxide alarms (if applicable) (within 10ft of sleeping rooms) FBC R315

- Details**
- Stair construction details indicate minimum 10" tread and 3/4" - 1 1/4" nosing, maximum 7.75" riser height, 6'-8" headroom height, 36" wide/deep landings at top and bottom, handrail location, 34"-38" handrail/guardrail heights, and maximum 4" open rail spacing FBC R311.7
  - Guards at porches, balconies, open stairs, ramps, raised floor more than 30" need guards: 34" at stairs and ramps, 36" all other areas FBC R312.1
  - Show fire protection (minimum 1/2" gypsum board) under stairs FBC R302.7
  - Bearing/Sheer/Opening/Header construction/details FBC 107
  - Wall section(s) from foundation through roof to include wall assembly of interior and exterior materials FBC R301
  - Frame walls have 2 layers of water-resistant barriers FBC R703.7.3
  - Chimney/Fireplace Details FBC R1001
  - Manufacturer specifications for factory-built fireplaces FBC R1005
  - Wall sheathing with nailing pattern indicated FBC R604
  - Roof sheathing with nailing pattern indicated FBC R803
  - Wood sill plate anchoring to foundation FBC R403.1.6, 602
  - Header and connection details for exterior and/or bearing walls FBC R602.7
  - Dormer framing details FBC 107
  - Provide gas layout FBC R G 2413
  - Provide soffit detail FBC R704



The following is a standard checklist for a condo remodel/ renovation similar to Plan Examining Commercial - Remodel Multi-Trade (all trades) Review in the rate sheet:

### CONDO KITCHEN/BATH RENOVATION

**NOTICE:** Effective January 1, 2023, a smoke alarm that is newly installed or replaces an existing battery-powered smoke alarm must be powered by the condo electrical system with a back-up battery that powers the alarm for at least 10 years. The battery requirements do not apply to a fire alarm, smoke detector, smoke alarm, or ancillary component that is electronically connected as part of a centrally monitored or supervised alarm system.

- I. Fire Protection
  - a. Fire Sprinkled? Y  or N  (If yes, show on plans)
  - b. Fire Alarm? Y  or N  (If yes, show on plans)
  - c. Show existing & proposed location for new or relocated fire sprinklers/fire alarms/smoke detectors/strobes/horns, etc.
  - d. State if smoke alarms are hardwired and /or interconnected. FBC 420, NFPA 72 & NFPA 13

II. Type of Construction (per FBC Ch. 6): **Check One**

Type I:   
Concrete & steel  
High-rise tower

Type II:   
Masonry & steel  
Mid & low-rise

Type III:   
Masonry & steel  
Wood roof or floor  
Mid & low-rise

Type V:   
Wood frame  
Construction  
Low-rise

\*Metal stud construction  
Fire treated wood

Wood Stud Construction  
Allowed

III. Show Floor Plans:  
Existing space

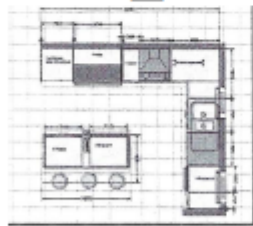

Proposed space



Basic overall condo layout



- IV. Indicate scope of work for:
  - a. HVAC: Relocated supply/RA or exhaust duct
  - b. PLBG: Relocated or new fixtures ~ provide Plbg ISO
  - c. ELEC: New/altered GFCI circuits ~ provide panel schedule

V. Replacing tile/wood flooring? Sound underlayment ~ Minimum 50 STC impact IIC rating required per (2020) Florida Building Code (FBC) 7<sup>th</sup> Edition, Section 1207

VI. Any change to the fire rated corridor, tenant 1hr wall, or penetration of wall or floor **ATTACH UL DETAIL.**



The following is a Solar Project Review checklist:

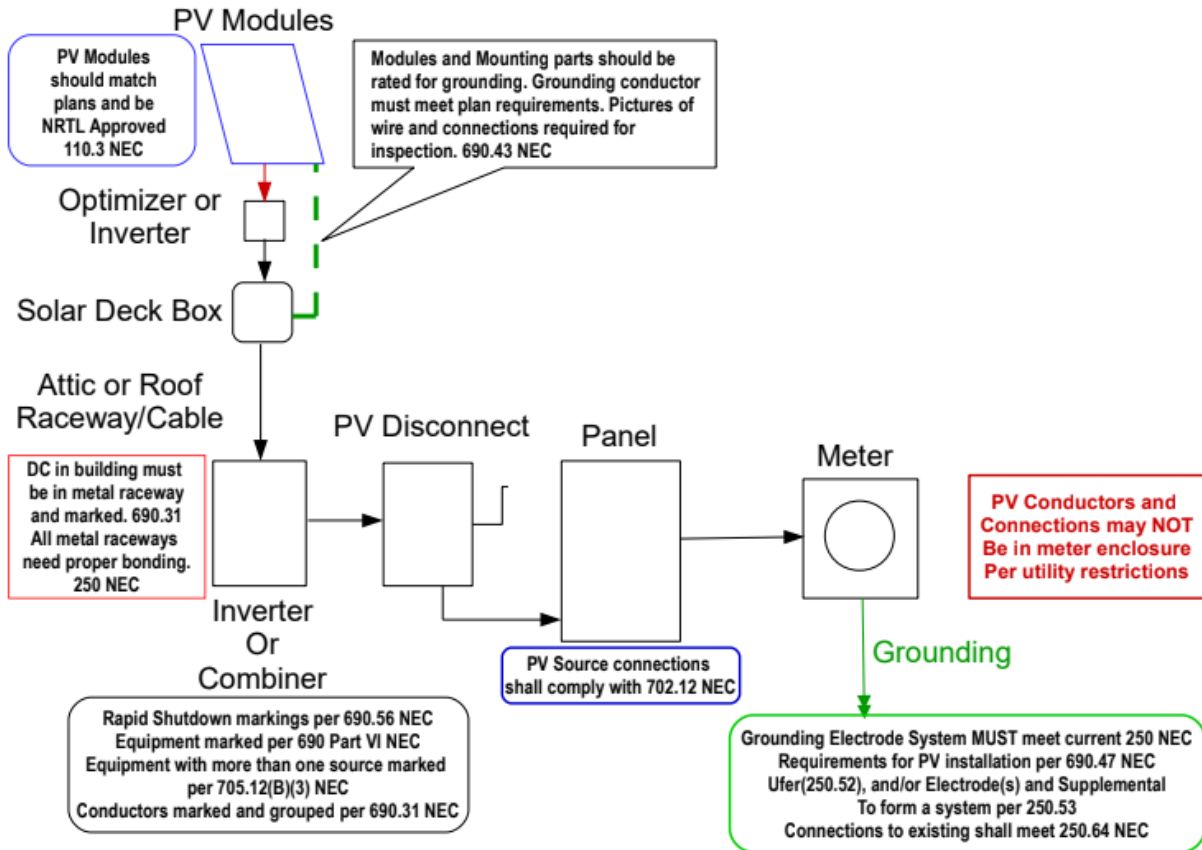



## **ADDITIONAL DATA**

JPI has completed Building Official, Plans Review, and Inspection services for St. Lucie County since 2018. We encourage the City to contact Monica Graziani at St Lucie County for reference.

# **SECTION VI**

# **STANDARD FORMS**

---

**The forms listed in this section are to be complete and submitted with your proposal.**





## DRUG~FREE WORKPLACE FORM

The undersigned vendor in accordance with Florida Statute 287.087 hereby certified that  
JPI \_\_\_\_\_ does:

*(Name of Business)*

1. Publish a statement notifying employees that the unlawful manufacture, distribution, dispensing, possession, or use of a controlled substance is prohibited in the workplace and specifying the actions that will be taken against employees for violations of such prohibition.
2. Inform employees about the dangers of drug abuse in the workplace, the business policy of maintaining a drug-free workplace, any available drug counseling, rehabilitation, and employee assistance programs, and the penalties that may be imposed upon employees for drug abuse violations.
3. Give each employee engaged in providing the commodities or contractual services that are proposed a copy of the statement specified in subsection (1).
4. In the statement specified in subsection (1), notify the employees that, as a condition of working on the commodities or contractual services that are under Bid, the employee will abide by the terms of the statement and will notify the employer of any conviction of, or plea of guilty or nolo contendere to, any violation of Chapter 893 or of any controlled substance law of the United States or any state, for a violation occurring in the workplace no later than five (5) days after such conviction.
5. Impose a sanction on, or require the satisfactory participation in a drug abuse assistance or rehabilitation program if such is available in the employees community, by any employee who is so convicted.
6. Make a good faith effort to continue to maintain a drug-free workplace through implementation of this section.

As the person authorized to sign the statement, I certify that this firm complies fully with the above requirements.

*Joseph Payne*

\_\_\_\_\_  
*Proposer's Signature*

06.05.23

\_\_\_\_\_  
*Date*

# Request for Taxpayer Identification Number and Certification

**Give Form to the  
 requester. Do not  
 send to the IRS.**

▶ Go to [www.irs.gov/FormW9](http://www.irs.gov/FormW9) for instructions and the latest information.

Print or type. See Specific Instructions on page 3.	1 Name (as shown on your income tax return). Name is required on this line; do not leave this line blank. <b>Joe Payne, Inc.</b>		
	2 Business name/disregarded entity name, if different from above <b>JPI</b>		
	3 Check appropriate box for federal tax classification of the person whose name is entered on line 1. Check only <b>one</b> of the following seven boxes.		4 Exemptions (codes apply only to certain entities, not individuals; see instructions on page 3):  Exempt payee code (if any) _____  Exemption from FATCA reporting code (if any) _____  <i>(Applies to accounts maintained outside the U.S.)</i>
	<input type="checkbox"/> Individual/sole proprietor or single-member LLC <input type="checkbox"/> C Corporation <input checked="" type="checkbox"/> S Corporation <input type="checkbox"/> Partnership <input type="checkbox"/> Trust/estate		
	<input type="checkbox"/> Limited liability company. Enter the tax classification (C=C corporation, S=S corporation, P=Partnership) ▶ _____ <b>Note:</b> Check the appropriate box in the line above for the tax classification of the single-member owner. Do not check LLC if the LLC is classified as a single-member LLC that is disregarded from the owner unless the owner of the LLC is another LLC that is <b>not</b> disregarded from the owner for U.S. federal tax purposes. Otherwise, a single-member LLC that is disregarded from the owner should check the appropriate box for the tax classification of its owner.		
	<input type="checkbox"/> Other (see instructions) ▶ _____		
	5 Address (number, street, and apt. or suite no.) See instructions. <b>5995 s a1A</b>		Requester's name and address (optional)
6 City, state, and ZIP code <b>Melbourne Beach FL 32951</b>			
7 List account number(s) here (optional)			

## Part I Taxpayer Identification Number (TIN)

Enter your TIN in the appropriate box. The TIN provided must match the name given on line 1 to avoid backup withholding. For individuals, this is generally your social security number (SSN). However, for a resident alien, sole proprietor, or disregarded entity, see the instructions for Part I, later. For other entities, it is your employer identification number (EIN). If you do not have a number, see *How to get a TIN*, later.

**Note:** If the account is in more than one name, see the instructions for line 1. Also see *What Name and Number To Give the Requester* for guidelines on whose number to enter.

<b>Social security number</b>									
<b>or</b>									
<b>Employer identification number</b>									
8	0	-	0	6	4	0	4	2	0

## Part II Certification

Under penalties of perjury, I certify that:

1. The number shown on this form is my correct taxpayer identification number (or I am waiting for a number to be issued to me); and
2. I am not subject to backup withholding because: (a) I am exempt from backup withholding, or (b) I have not been notified by the Internal Revenue Service (IRS) that I am subject to backup withholding as a result of a failure to report all interest or dividends, or (c) the IRS has notified me that I am no longer subject to backup withholding; and
3. I am a U.S. citizen or other U.S. person (defined below); and
4. The FATCA code(s) entered on this form (if any) indicating that I am exempt from FATCA reporting is correct.

**Certification instructions.** You must cross out item 2 above if you have been notified by the IRS that you are currently subject to backup withholding because you have failed to report all interest and dividends on your tax return. For real estate transactions, item 2 does not apply. For mortgage interest paid, acquisition or abandonment of secured property, cancellation of debt, contributions to an individual retirement arrangement (IRA), and generally, payments other than interest and dividends, you are not required to sign the certification, but you must provide your correct TIN. See the instructions for Part II, later.

<b>Sign Here</b>	Signature of U.S. person ▶ <i>Joseph Payne</i>	Date ▶ <i>1.23.23</i>
------------------	--	-----------------------

## General Instructions

Section references are to the Internal Revenue Code unless otherwise noted.

**Future developments.** For the latest information about developments related to Form W-9 and its instructions, such as legislation enacted after they were published, go to [www.irs.gov/FormW9](http://www.irs.gov/FormW9).

## Purpose of Form

An individual or entity (Form W-9 requester) who is required to file an information return with the IRS must obtain your correct taxpayer identification number (TIN) which may be your social security number (SSN), individual taxpayer identification number (ITIN), adoption taxpayer identification number (ATIN), or employer identification number (EIN), to report on an information return the amount paid to you, or other amount reportable on an information return. Examples of information returns include, but are not limited to, the following.

- Form 1099-INT (interest earned or paid)

- Form 1099-DIV (dividends, including those from stocks or mutual funds)
- Form 1099-MISC (various types of income, prizes, awards, or gross proceeds)
- Form 1099-B (stock or mutual fund sales and certain other transactions by brokers)
- Form 1099-S (proceeds from real estate transactions)
- Form 1099-K (merchant card and third party network transactions)
- Form 1098 (home mortgage interest), 1098-E (student loan interest), 1098-T (tuition)
- Form 1099-C (canceled debt)
- Form 1099-A (acquisition or abandonment of secured property)

Use Form W-9 only if you are a U.S. person (including a resident alien), to provide your correct TIN.

*If you do not return Form W-9 to the requester with a TIN, you might be subject to backup withholding. See What is backup withholding, later.*



## REFERENCES

**RFP NO. 2023-039**  
**ANNUAL CONTRACT FOR PLAN REVIEW SERVICES**

Proposers shall submit as a part of the bid package, two (2) Customer references with name of the customer, address, contact person, and telephone number.

<b>Name</b> St. Lucie County	<b>Name</b> City of Palm Bay
<b>Contact:</b> Monica Graziani	<b>Contact:</b> Val Perez
<b>Address:</b> 2300 Virginia Avenue Fort Pierece, FL 34982	<b>Address:</b> 190 Malabar Rd Ste 105, Palm Bay, FL
<b>Telephone:</b> 772.462.1599	<b>Telephone:</b> 321.952.3400 x 5887
<b>Email:</b> grazianim@stlucieco.org	<b>Email:</b> valentino.perez@palmbayflorida.org
<b>Name</b> City of Melbourne	
<b>Contact:</b> Steve Innes	
<b>Address:</b> 900 E. Strawbridge Ave. Melbourne, FL 32901	
<b>Telephone:</b> 321.608.7929	
<b>Email:</b> Steve.Innes@mlbfl.org	

**PROPOSAL PRICING FORM**  
**RFP NO. 2023-039 ~ ANNUAL CONTRACT FOR PLAN REVIEW SERVICES**

The following proposal(s) is submitted on behalf of: JPI for the requested services, in accordance with the agreements and specifications contained in RFP No. 2023-039.

We have carefully examined that this proposal package and understand the provisions, terms, and conditions concerning the equipment, materials, supplies or services as called for. With full knowledge and understanding of the requirements in the Proposal Package, We hereby agree to furnish and deliver services as indicated at the prices quoted herein as follows:

**NOTE:** All price columns must be completed. Where indicated, provide pricing for demolition including the removal of slabs (including slabs) and pricing in instances where slabs remain and are not removed (excluding slabs).

ITEM	DESCRIPTION	HOURLY RATE
1	<ul style="list-style-type: none"> <li>• <u>Perform plan review services.</u></li> <li>• Per Inspector: Approximately 8 hours per day, 37.5- 40 hours per week.</li> </ul>	<b><u>BLDG, M,E, or P</u></b>
		<b>1 + 2 Family</b>
		<b>Multi</b>
2	<ul style="list-style-type: none"> <li>• Full-Time Plan Reviewer</li> <li>• Perform plan review services.</li> <li>• Per Plan reviewer: In excess of 40 hours per week.</li> </ul>	\$ 82 per hour
		<b>1 + 2 Family</b>
		\$ 82 per hour
3	<ul style="list-style-type: none"> <li>• Perform plan review services.</li> <li>• Per Plan Reviewer: 4 hours per day, 18 – 22 hours per week.</li> </ul>	\$ 82 per hour
		<b>1 + 2 Family</b>
		\$ 82 per hour
4	<ul style="list-style-type: none"> <li>• <u>Perform plan review services.</u></li> <li>• <u>Pre Plan Reviewer On an needed basis</u></li> <li>• As needed Plan Review</li> </ul>	\$ 82 per hour
		<b>1 + 2 Family</b>
		\$ 82 per hour

# CITY OF FORT PIERCE PROPOSER'S CHECKLIST

This checklist is provided to assist each Proposer in the preparation of their bid response. Included in this checklist are important requirements, which is the responsibility of each Proposer to submit with their response in order to make their response fully compliant. This checklist is only a guideline, it is the responsibility of each Proposer to read and comply with the Invitation to Bid in its entirety.

**Check "Yes" or "No" to each of the following:**

	<b>YES</b>	<b>NO</b>
Is Request for Proposal cover page (page 1) completed, signed and attached?	<u>  X  </u>	<u>      </u>
Include proof of proper licensing as stated in proposal documents.	<u>  X  </u>	<u>      </u>
Include proof of proper insurance as stated in proposal documents.	<u>  X  </u>	<u>      </u>
Did you include a list of all materials and equipment to be used in providing the service?	<u>  X  </u>	<u>      </u>
Is Drug-Free Workplace form signed and enclosed?	<u>  X  </u>	<u>      </u>
Proposal envelope is marked accordingly	<u>  X  </u>	<u>      </u>
Are two (2) complete proposal packages included (one original and one electronic copy (PDF) on a USB Flash Drive) of sealed proposals?	<u>      </u>	<u>  X  </u>
Disregard, if you are going to utilize the electronic submission option.	<u>  X  </u>	<u>      </u>
Is each Addendum (when issued) signed and included?	<u>  X  </u>	<u>      </u>

**PLEASE SIGN AND RETURN WITH PROPOSAL** \_\_\_\_\_ *Joseph Payne*

JPI acknowledges all addenda

*Joseph Payne*                      06.05.23



# CERTIFICATE OF LIABILITY INSURANCE

DATE (MM/DD/YYYY)

3/17/2023

THIS CERTIFICATE IS ISSUED AS A MATTER OF INFORMATION ONLY AND CONFERS NO RIGHTS UPON THE CERTIFICATE HOLDER. THIS CERTIFICATE DOES NOT AFFIRMATIVELY OR NEGATIVELY AMEND, EXTEND OR ALTER THE COVERAGE AFFORDED BY THE POLICIES BELOW. THIS CERTIFICATE OF INSURANCE DOES NOT CONSTITUTE A CONTRACT BETWEEN THE ISSUING INSURER(S), AUTHORIZED REPRESENTATIVE OR PRODUCER, AND THE CERTIFICATE HOLDER.

**IMPORTANT:** If the certificate holder is an ADDITIONAL INSURED, the policy(ies) must have ADDITIONAL INSURED provisions or be endorsed. If SUBROGATION IS WAIVED, subject to the terms and conditions of the policy, certain policies may require an endorsement. A statement on this certificate does not confer rights to the certificate holder in lieu of such endorsement(s).

<b>PRODUCER</b> Straight-Line Insurance, LLC 1301 Grasslands Blvd., Suite 100 Lakeland, FL 33803  www.straightlinellc.com	<b>CONTACT NAME:</b> Straight-Line Insurance, LLC <b>PHONE (A/C. No. Ext):</b> 863-904-4776 <b>E-MAIL ADDRESS:</b> info@straightlinellc.com	<b>FAX (A/C. No.):</b>
	<b>INSURER(S) AFFORDING COVERAGE</b>	
<b>INSURED</b> Joe Payne, Inc JPI 5995 S Hwy A1A Melbourne Beach FL 32951	<b>INSURER A:</b> Certain Underwriters at Lloyd's of London	<b>NAIC #</b> 32727
	<b>INSURER B:</b> Infinity Auto Insurance Company	11738
	<b>INSURER C:</b> Insurance Company of the West (ICW)	27847
	<b>INSURER D:</b> Burlington Insurance Company	23620
	<b>INSURER E:</b>	
	<b>INSURER F:</b>	

**COVERAGES**

CERTIFICATE NUMBER: 73468209

REVISION NUMBER:

THIS IS TO CERTIFY THAT THE POLICIES OF INSURANCE LISTED BELOW HAVE BEEN ISSUED TO THE INSURED NAMED ABOVE FOR THE POLICY PERIOD INDICATED. NOTWITHSTANDING ANY REQUIREMENT, TERM OR CONDITION OF ANY CONTRACT OR OTHER DOCUMENT WITH RESPECT TO WHICH THIS CERTIFICATE MAY BE ISSUED OR MAY PERTAIN, THE INSURANCE AFFORDED BY THE POLICIES DESCRIBED HEREIN IS SUBJECT TO ALL THE TERMS, EXCLUSIONS AND CONDITIONS OF SUCH POLICIES. LIMITS SHOWN MAY HAVE BEEN REDUCED BY PAID CLAIMS.

INSR LTR	TYPE OF INSURANCE	ADDL INSD	SUBR WVD	POLICY NUMBER	POLICY EFF (MM/DD/YYYY)	POLICY EXP (MM/DD/YYYY)	LIMITS
D	<input checked="" type="checkbox"/> <b>COMMERCIAL GENERAL LIABILITY</b> <input type="checkbox"/> CLAIMS-MADE <input checked="" type="checkbox"/> OCCUR  GEN'L AGGREGATE LIMIT APPLIES PER: <input type="checkbox"/> POLICY <input checked="" type="checkbox"/> PRO-JECT <input type="checkbox"/> LOC OTHER:	<input checked="" type="checkbox"/>	<input checked="" type="checkbox"/>	738BG02358-03	4/7/2023	4/7/2024	EACH OCCURRENCE \$1,000,000 DAMAGE TO RENTED PREMISES (Ea occurrence) \$100,000 MED EXP (Any one person) \$5,000 PERSONAL & ADV INJURY \$1,000,000 GENERAL AGGREGATE \$2,000,000 PRODUCTS - COMP/OP AGG \$ Included \$
B	<input type="checkbox"/> ANY AUTO <input type="checkbox"/> OWNED AUTOS ONLY <input type="checkbox"/> SCHEDULED AUTOS <input checked="" type="checkbox"/> HIRED AUTOS ONLY <input checked="" type="checkbox"/> NON-OWNED AUTOS ONLY <input checked="" type="checkbox"/> Allowed Autos	<input checked="" type="checkbox"/>	<input checked="" type="checkbox"/>	509-82007-3557-001	6/18/2022	6/18/2023	COMBINED SINGLE LIMIT (Ea accident) \$1,000,000 BODILY INJURY (Per person) \$5,000 BODILY INJURY (Per accident) \$100,000 PROPERTY DAMAGE (Per accident) \$ EXCESS COVERAGE \$100,000
D	<input type="checkbox"/> <b>UMBRELLA LIAB</b> <input checked="" type="checkbox"/> OCCUR <input checked="" type="checkbox"/> <b>EXCESS LIAB</b> <input type="checkbox"/> CLAIMS-MADE DED RETENTION \$	<input checked="" type="checkbox"/>	<input checked="" type="checkbox"/>	HFF0012529-3	4/7/2023	4/7/2024	EACH OCCURRENCE \$2,000,000 AGGREGATE \$2,000,000 \$
C	<b>WORKERS COMPENSATION AND EMPLOYERS' LIABILITY</b> ANY PROPRIETOR/PARTNER/EXECUTIVE OFFICER/MEMBER EXCLUDED? (Mandatory in NH) If yes, describe under DESCRIPTION OF OPERATIONS below	Y/N <input checked="" type="checkbox"/> Y	N/A	WFL 5054011 03	3/6/2023	3/6/2024	<input checked="" type="checkbox"/> PER STATUTE <input checked="" type="checkbox"/> OTH-ER E.L. EACH ACCIDENT \$1,000,000 E.L. DISEASE - EA EMPLOYEE \$1,000,000 E.L. DISEASE - POLICY LIMIT \$1,000,000
A	Professional Liability	<input checked="" type="checkbox"/>	<input checked="" type="checkbox"/>	PLC-01064-00	6/19/2022	6/19/2023	Per Claim/Agg: \$2,000,000 / \$2,000,000 Deductible: \$25,000

DESCRIPTION OF OPERATIONS / LOCATIONS / VEHICLES (ACORD 101, Additional Remarks Schedule, may be attached if more space is required)

Auto Liability Coverage Form - Hired Auto, Non-Owned Endorsement  
 E919 - Blanket Waiver of Transfer Rights of Recovery Against Others  
 E921 - Additional Insured - Primary and Non-Contributory

**CERTIFICATE HOLDER**

St. Lucie County BOCC  
 2300 Virginia Avenue - FL 3  
 Fort Pierce, FL 34982-5632

**CANCELLATION**

SHOULD ANY OF THE ABOVE DESCRIBED POLICIES BE CANCELLED BEFORE THE EXPIRATION DATE THEREOF, NOTICE WILL BE DELIVERED IN ACCORDANCE WITH THE POLICY PROVISIONS.

AUTHORIZED REPRESENTATIVE

John Nicholas Davis

© 1988-2015 ACORD CORPORATION. All rights reserved.

ACORD 25 (2016/03)

The ACORD name and logo are registered marks of ACORD

# APPENDICES

---

## **DemandStar Instructions How to use E-Bidding**

<p><b>DELIVER TO:</b>  City of Fort Pierce, Purchasing Division  Room 101  100 North U.S. #1  Fort Pierce, FL 34950</p> <p><b>MAIL TO:</b>  City of Fort Pierce Purchasing Division,  Room 101  P.O. Box 1480  Fort Pierce, FL 34954-1480</p>	<p align="center"><b>CITY OF FORT PIERCE</b></p>  <p align="center"><b>REQUEST FOR PROPOSALS  and  PROPOSER ACKNOWLEDGMENT</b></p>
<p><b>Bid Writer:</b> Georgia Montgomery, 772-467- 3102</p>	<p><b>RFP No:</b> 2023-039</p>
<p><b>Pre-Proposal Conference Date:</b>  11:00AM, MONDAY, MAY 22, 2023</p>	<p><b>RFP Title:</b> ANNUAL CONTRACT FOR  PLAN REVIEW SERVICES</p>
<p><b>Pre-Proposal Location:</b>  CITY HALL, 1ST FLOOR CONFERENCE  ROOM 100 N. US HIGHWAY 1, FORT PIERCE,  FL</p>	<p><b>RFP Opening Location:</b>  City of Ft. Pierce Purchasing Division  Room 101  100 North U.S. #1, 1st Floor  Ft. Pierce, Florida 34950</p>
<p><b>RFP Due Date &amp; Time:</b>  3:30 PM, TUESDAY, JUNE 6, 2023</p>	<p>If you need any reasonable accommodation for any type of disability in order to participate in this procurement, please contact this department as soon as possible.</p>
<p><b>Proposer Name:</b> JPI  -----  <b>Mailing Address:</b> 5995 S A1A, Melbourne FL  32951</p>	<p><i>I hereby certify that this bid is made without prior understanding, agreement, or connection with any corporation, firm, or person submitting a bid for the same materials, supplies or equipment, and is in all respects fair and without collusion or fraud. I agree to abide by all conditions of this bid and certify that I am authorized to sign this bid for the bidder.</i></p> <p>X _____  Authorized Signature (Manual)</p>
<p>5995 S A1A, Melbourne FL 32951 :</p>	<p>Joseph Payne</p>
<p><b>Type of Entity (Select one):</b>  Corporation <input checked="" type="checkbox"/> _____  Partnership _____  Proprietorship _____</p>	<p>President</p>
<p>Incorporated in FL 2010</p>	<p>30 _____ days, ARO</p>
<p>813.520.1683</p>	<p>Payment Terms: Net 30 Days</p>
<p>813.520.1683</p>	<p>80 064 0420</p>
<p>joe@jpiiflorida.com</p>	<p>Local Business: ___Y ___x_N MWBE: ___Y ___x_N</p>
<p>Bid Security is attached, when required, in the amount of \$ _____  F.O.B. DESTINATION</p>	<p>If returning as a "No Bid" state reason:</p>
<p align="center"><b>THIS PAGE MUST BE COMPLETED AND RETURNED WITH YOUR BID</b></p>	





**RFP No. 23-039**

**Annual Contract for Plan Review Services**

**Submitted to:**

City of Fort Pierce – Purchasing Division  
100 North U.S. #1  
Fort Pierce, FL 34954

**Contact:**

Paul Thomas, Building Official  
Phone: 727-489-3194  
Email: [frseaffer@cityoffortpierce.com](mailto:frseaffer@cityoffortpierce.com)

By:

June 6<sup>th</sup> at 3:30pm (EST) (Date of Proposal)

From:



5995 S A1a  
Melbourne, FL 32951  
c/o Joe Payne, PE MBA  
[joe@jpiflorida.com](mailto:joe@jpiflorida.com)/ 813-520-1683

Submittal: Demandstar website



## **JPI TABLE OF CONTENTS**

JPI provides the following Table of Contents for the major areas of the response. This report consecutively numbers all pages in the footer.

Section 1	LETTER OF TRANSMITTAL	1-2
Section 2	ORGANIZATION PROFILE AND QUALIFICATIONS	3-17
Section 3	GENERAL INFORMATION	18-19
Section 4	CERTIFICATES	20
Section 5	FINANCIAL DATA	21
Section 6	SCOPE OF WORK	22-29
Section 7	ADDITIONAL DATA	30



## LETTER OF TRANSMITTAL

June 5<sup>th</sup>, 2023

RFP No. 2023-039

City of Fort Pierce, Purchasing Division  
Room 101  
100 North U.S. #1  
Fort Pierce, FL 34950

### ANNUAL CONTRACT FOR PLAN REVIEW SERVICES

Dear Mr. Thomas and Members of the Evaluation Committee,

JPI is pleased to present our response to this advertisement. JPI appreciates the opportunity to submit our qualifications on this contract. **JPI has served the St. Lucie County Building Department since 2018 and wished to begin a relationship with the City of Fort Pierce.** JPI is 100 percent committed to government services, has no private industry clients, and has zero conflicts to the work of this contract. Please let this letter serve as our formal agreement to be bound by the submittal without modifications unless mutually agreed to upon further negotiations between The City and JPI. We have been in business for 13 years. We are qualified under the laws, rules, and regulations of the State of Florida to perform the work required by these contract documents. Our sunbiz.org document number is P10000059808 and Joe Payne is a Professional Engineer with a PE license of 55751. JPI assures our ability to meet the insurance and performance requirements set out in this RFP if selected for award. We certify we maintain a drug-free workplace program compliant with the standards within Florida Statutes § 440.102.

JPI's specialization is providing professional services to Building Departments, which is the purpose of this advertisement. JPI has a municipal service line dedicated 100% to serving public agencies with no conflicts of interest. JPI has local staff throughout the twenty municipalities that we service in the Tampa Bay area. As a summary of past experience supporting JPI's qualifications to perform these professional services, we offer the following:

1. JPI has worked in the area since 2018 over the course of our contract with St. Lucie County, through their reciprocal agreement with the County.
2. JPI routinely completes plan review for work within unincorporated St. Lucie County with a Fort Pierce post office address.



3. JPI is the consultant for numerous building departments in the Treasure Coast area including Martin County, City of Stuart, Indian River County, Brevard County, City of Melbourne, City of Palm Bay and in Okeechobee County.
4. Since 2018, JPI plan reviewers completed an estimated 10,000 plan reviews for St. Lucie County many of which were local to the City.
5. The Project Manager, Joe Payne, is the President of JPI and has 100% control of all resources proposed for RFP 2023-039, and fully commits to use these resources.
6. The JPI President will come out of the office to fulfill service requests on this contract.
7. JPI proposes professionals possessing all required licensure within this RFP. JPI proposes more than ten five back-up plans examiners to begin any future work.
8. JPI has a municipal service line which currently is 100% committed to servicing Building Departments.
9. JPI has personnel available currently to service in-house plan examiner roles.
10. JPI has local staff who will serve this contract.

**Joe Payne, PE** will be the binding agent and point of contact for this contract. Mr. Payne is the President of the company and a professional engineer with 30 years of experience. He will be the project manager for this contract #2023-039 and takes responsibility for review services. JPI is a Florida Owned Corporation and a statewide Professional Service firm. JPI was founded in 2010 after servicing state contracts as a sole proprietor for several years. The municipal service line is the primary source of business revenue for JPI. We look forward to working with The City.

In closing, JPI thanks you for the opportunity to submit on Contract 2023-039 and JPI wishes to establish an excellent working relationship with the City of Fort Pierce.

Sincerely,

Joe Payne, PE, President

[joe@jpiflorida.com](mailto:joe@jpiflorida.com)

800-488-1956





3. JPI is the consultant for numerous building departments in the Treasure Coast area including Martin County, City of Stuart, Indian River County, Brevard County, City of Melbourne, City of Palm Bay and in Okeechobee County.
4. Since 2018, JPI plan reviewers completed an estimated 10,000 plan reviews for St. Lucie County many of which were local to the City.
5. The Project Manager, Joe Payne, is the President of JPI and has 100% control of all resources proposed for RFP 2023-039, and fully commits to use these resources.
6. The JPI President will come out of the office to fulfill service requests on this contract.
7. JPI proposes professionals possessing all required licensure within this RFP. JPI proposes more than ten five back-up plans examiners to begin any future work.
8. JPI has a municipal service line which currently is 100% committed to servicing Building Departments.
9. JPI has personnel available currently to service in-house plan examiner roles.
10. JPI has local staff who will serve this contract.

**Joe Payne, PE** will be the binding agent and point of contact for this contract. Mr. Payne is the President of the company and a professional engineer with 30 years of experience. He will be the project manager for this contract #2023-039 and takes responsibility for review services. JPI is a Florida Owned Corporation and a statewide Professional Service firm. JPI was founded in 2010 after servicing state contracts as a sole proprietor for several years. The municipal service line is the primary source of business revenue for JPI. We look forward to working with The City.

In closing, JPI thanks you for the opportunity to submit on Contract 2023-039 and JPI wishes to establish an excellent working relationship with the City of Fort Pierce.

Sincerely,

A handwritten signature in blue ink, appearing to read "Joe Payne", is written over a light blue horizontal line.

Joe Payne, PE, President

[joe@jpiflorida.com](mailto:joe@jpiflorida.com)

800-488-1956





## ORGANIZATION PROFILE AND QUALIFICATIONS

JPI has served the St. Lucie County Building Department since 2018

JPI is a statewide professional service firm, primarily serving municipal clients; specifically, building departments. JPI is a civil engineering company with a broad range of in-house professionals including Building Code Administrator professionals, Architects, and Engineers. JPI services over thirty similar clients, including the St. Lucie County Building Department. Joe Payne, PE, the Founder and President will serve as the Project Manager. Kevin Singley, CBO, Pete Swarr, PE, Scott Seigel, PE,

and Andrew Manero, RA, are key/ primary individuals planned for this work. See the provided resumes for their experience. JPI's current production capacity is 1800 man-hours per week. Our current weekly commitment equals 1400 man-hours per week. We have a surplus capacity of 400 man-hours per week, ten full time equivalents, to service this contract. JPI has thirty licensed plan reviewers available and the President, Mr. Payne, does perform plan review services for JPI when needed by the client.

JPI has no conflicts of interest to this contract.

Joe Payne, PE, will be the binding agent and point of contact and Project Manager for this contract. Mr. Payne is the President of the company and a professional engineer with 30 years of experience. He has over 30 years of construction and engineering experience. He is a multi-discipline engineer well suited for the role of managing this RFP, which is a multi-discipline plans review contract. JPI is a Florida Owned Corporation and a statewide Professional Service firm. JPI was founded in 2010 after servicing state contracts as a sole proprietor for several years. The municipal service line is the primary source of business revenue for JPI. In closing, JPI thanks you for the opportunity to bid on this contract and JPI wishes to establish an

excellent working relationship with the City. JPI has a staff of 45 professionals including full-time and part-time personnel. JPI will not subcontract any services under this contract. JPI only services municipal clients at this time, we have not private industry clients at this time, and are



completely committed to serve the City without conflict. Over the last decade, JPI completed approximately 50,000 man-hours of plan review work for building departments, and we estimate approximately 50,000 plan reviews. Reviews vary from over-the-counter reviews such as roof permits to multi-store commercial high-rise hotels. A unique reason to continue to select JPI is that JPI already performs these services statewide in Florida with current staffing who are available for the work.

JPI has completed an estimated 50,000 plan reviews in ten years.

JPI will handle variable service levels on this contract.

The main benefit that JPI provides with our applied knowledge is **PROBLEM SOLVING**. This allows JPI to efficiently solve problems provided by the community during the application process. JPI provides a depth of services to our clientele with a variety of professionals including Engineers and Architects. This depth allows JPI to consider multi-discipline approaches to problems through our multi-discipline expertise. JPI has a competitive operational advantage to servicing this contract. The contract likely requires *variable service levels which may change weekly and daily*. JPI staffing includes part-time personnel and on-call personnel, who may become available to complete this contract

on short notice. In addition, from our statewide presence, JPI has the financial resources to sustain staffing long term on this contract, even during periods when the City has zero service needs. Conversely, JPI also has the staffing resources to quickly increase to a production level of ten employees per week, with very little notice. JPI has the capacity to handle both high and low volume at any time.

JPI has no current private industry clients.

JPI is the consultant for numerous building departments in the area including St. Lucie County, Martin County, Okeechobee School Board, and previously Indian River County. Also, we serve Brevard County, City of Melbourne, City of Palm Bay, City of Titusville, Indian Harbour Beach, and Cape Canaveral. Expanding, we service Lake County, City of Clermont, City of Altamonte Springs, City of Lake Mary, and City of Fernandina Beach. Also, we have a statewide presence through servicing agencies such as the City of Clearwater, City of Largo, City of St. Pete Beach, City of St. Petersburg, City of Treasure Island, City of

South Pasadena, Town of Redington Shores, City of Pinellas Park, City of Tampa, Hillsborough County, and City of Tarpon Springs. JPI is a consultant for Sarasota County, City of Anna Maria, Town of Longboat Key, Charlotte County, and Lee County Florida.



The following organizational charts provide the Key Staff members for this contract. Consider them the first source of professionals for work:

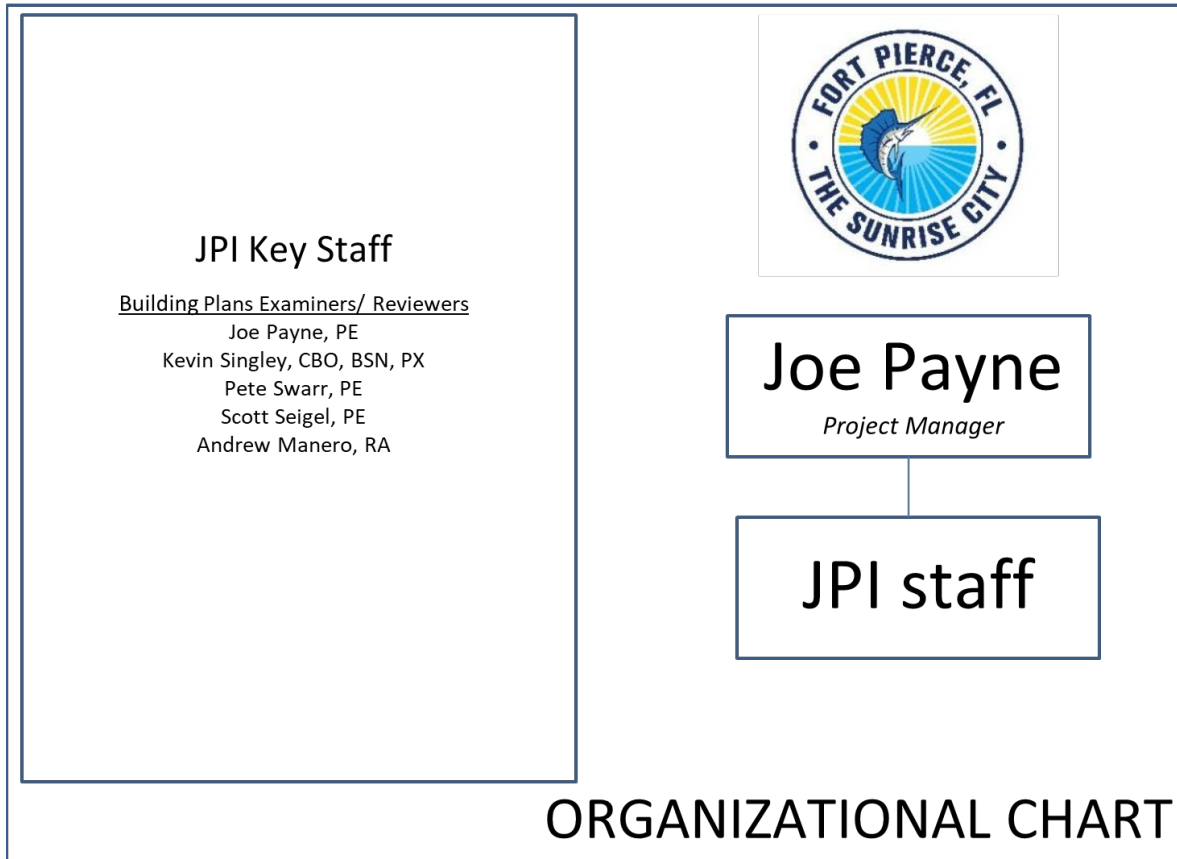

The following summarizes our professional licensure for current employees:





<u>JPI</u>	<u>DBPR</u>
Joe Payne	FLPE55751
Greg Perlin	BN6576
Jorge Cedeno	BN4702
Jack McCabe	BN4613
Jason Steele	FLPE69234
Cory Brockett	FLPE74677
Bob Hightower	BN2430
Doug Walton	AR0007045
Greg Martin	BN3947, PX1848
Andrew Mareno	AR96338
Eddie Page	FLPE69045
Pete Swarr	FLPE44159
Robert Bryce	PX2783
Scott Seigel	FLPE60980
Andrew West	FLPE60301
Dan Folwell	BN6927
Rick Hoepner	FLPE23319
Ryan Ferry	BN6617
Mark Thornbloom	FLPE50107
Jon Thomas	BN7125
Kevin Singley	PX3601, BN4798, BU1872
Micheal Tew	PX2675, BN5003
Tony Murphy	AR100424
Luke Curtis	BU1975,RPX279,PX3717, CN6614
James Crouch	BN8698
Glenn Hall	PX3599, BN5324
Robert Peck	BN7567
Ezz Elgayar	BN6415



We provide the following five key references and also ten additional references:

- 1) **City of Palm Bay** - Valentino Perez, CBO, City of Palm Bay, 321-726-5614
- 2)

Interim Building Official and Multi-trade Inspection Services and Plans Examination Services.  
Also, Public Works professional services.

*Joe Payne, Kevin Singley, Andrew Manero, Pete Swarr, Scott Seigel, Abraham Chabab, and Jorge Cedeno have worked on this contract. 2016 to current status – Approximately \$2.2M of services. **Three contract renewals.***

- 2) **St. Lucie County Government** - Monica Graziani | Building & Code Regulation Manager, Planning & Development Services, Ph: 772-462-1599 | 2300 Virginia Avenue, Fort Pierce, FL 34982, grazianim@stlucieco.org | [www.stlucieco.org](http://www.stlucieco.org)

Interim Building Official and Multi-trade Inspection Services and Plans Examination Services.  
*Joe Payne, Andrew Manero, Pete Swarr, Scott Seigel, and James McGuinness have worked on this contract/ 2018 to current status- approximately \$2.0M of services. **Four contract renewals.***

- 3) **Indian River County Government** - Scott P. McAdam, CBO, MCP, Building Official, Indian River County, Phone (772)226-1268, Fax (772) 770-5333.

Multi-trade Inspection Services and Plans Examination Services  
*2017 to current status – approximately \$1M of services.*

- 4) **Brevard County Government** – Terry Talbert, CBO  
2725 Judge Fran Jamieson Way, Viera, Fl 32940, 321-633-2072 Ex. 52678/Fax 321-633-2087

Multi-trade Inspection Services and Plans Examination Services  
*Joe Payne, Doug Walton, Greg Martin, Pete Swarr, Rick Hoepner, Scott Seigel, MarkThornbloom, Andrew Manero, John Wiggins, and Andrew Chabab have worked on this contract/ 2016 to current status– approximately \$4M of services. **Three contract renewals.***

- 5) **City of Melbourne** - Steve Innes BCA FCA CFM | Building Official, Ph: 321-608-7926 | 900 E Strawbridge Ave, Melbourne, FL 32901, Steve.Innes@mlbfl.org|

Multi-trade Inspection Services and Plans Examination Services.  
*Joe Payne, Andrew Manero, Greg Martin, and Scott Seigel have worked on this contract/ 2016 to current status- approximately \$0.5M of services. **Three contract renewals.***



1) **City of Clearwater - Kevin Garriott, CBO, 727-562-4567**

SCOPE: Multi-trade Inspection Services and Plans Examination Services.

DATE OF SERVICE: 2016- Current. *Three contract renewals.*

RESPONSIBILITIES: *Joe Payne, John Fahey, Joe Aukstikalnis, David Wilcox, Cory Brockett, and Greg Perlin. 2016 to current status – Approximately \$1.2M of services. All work is completed within budget and schedule. The following summarizes our responsibilities:*

- Commercial and Residential Professional Service Experience: JPI staffs the contract with up to three daily inspectors throughout the life of the contract. In addition, JPI provides up to two in-house plan review professionals as needed by the City to target a ten-day turnaround for reviews. JPI utilizes ePermits for inspections and plan reviews. Completes residential and commercial inspections and plans review.
- Firm and Staff Contract Experience: All full-time staff on the contract are fully licensed as Engineers, Architects, or Building Code professionals and complete multi-trade assignments. JPI provides licensed CFMs for floodplain work. **JPI provides licensed commercial and residential plan reviewers (multi-trade) and provides licensed commercial and residential inspectors (multi-trade).**
- Costs: JPI provides a daily 25-50% cost savings to the City through the use of multi-trade professionals. For example, JPI professionals are licensed for both residential and commercial work, could have one professional handle both in a route, rather than needing two professionals. There were no change orders.



## 2) City of St. Pete Beach – Julie Anderson, CBO, 727-363-9244

SCOPE: Multi-trade Inspection Services and Plans Examination Services

DATE OF SERVICE: 2022- Current. *Sole source vendor*

RESPONSIBILITIES: *Joe Payne, Luke Curtis, Jon Thomas, Ryan Ferry, and Scott Seigel, have worked on this contract. 2022 to current status – Approximately \$0.1M of services. All work is completed within budget and schedule. The following summarizes our responsibilities:*

- Commercial and Residential Professional Service Experience: JPI staffs the contract typically with one daily inspector throughout the life of the contract. In addition, JPI provides remote commercial and multi-family residential plan review (iWorq) as needed by the City to target a ten-day turnaround for reviews. JPI works remotely and receives assignments from iWorq. JPI enters results electronically. Completes residential and commercial inspections and plans review.
- Firm and Staff Contract Experience: JPI provides both inspection and plans review services during the contract. All full-time staff on the contract are fully licensed as Engineers, Architects, or Building Code professionals and complete multi-trade assignments. **JPI provides licensed commercial and residential plan reviewers (multi-trade) and provides licensed commercial and residential inspectors (multi-trade).**
- Costs: JPI provides a daily 25-50% cost savings to the City through the use of multi-trade professionals. JPI covered vacation leave for City personnel on routine occasions. There were no change orders.



### 3) **Pinellas County** – *Eve Spencer, CBO, AIA, 727-464-3752*

SCOPE: Multi-trade Inspection Services and Plans Examination Services.

DATE OF SERVICE: 2013- *Current. **Four contract renewals. Two renewals as sole source.***

RESPONSIBILITIES: *Joe Payne, Jack McCabe, Jon Thomas, Bob Hightower, David Wilcox, Cory Brockett, Andrew Manero, Scott Seigel and Greg Perlin. 2013 to current status – Approximately \$7.0M of services. All work is completed within budget and schedule. The following summarizes our responsibilities:*

- Commercial and Residential Professional Service Experience: JPI staffs the contract with up to ten daily inspectors throughout the life of the contract. In addition, JPI is an interim in-house plan review professional to target a ten-day turnaround for reviews. JPI utilizes hard copy tickets for inspections which were received at a standing morning meeting. Completes residential and commercial inspections.
- Firm and Staff Contract Experience: All full-time staff on the contract are fully licensed as Engineers, Architects, or Building Code professionals and complete multi-trade assignments. *For periods of time, JPI is the sole vendor for the Department completing up to 250 daily inspections. **JPI provides licensed commercial and residential plan reviewers (multi-trade) and provides licensed commercial and residential inspectors (multi-trade).***
- Costs: JPI provides a daily 25% cost savings to the County through the use of multi-trade professionals. For example, JPI professionals are licensed for both residential and commercial work, could have one professional handle both in a route, rather than needing two professionals. There were no change orders.



4) **City of Tarpon Springs** – *Kevin Powell, CBO, CFM, 727-942-5604*

SCOPE: Multi-trade Inspection Services and Plans Examination Services

DATE OF SERVICE: 2017- *Current. **Three contract renewals/ Two renewals as sole source.***

RESPONSIBILITIES: *Joe Payne, Ezz Elgayar, and Cory Brockett, have worked on this contract. 2017 to current status – Approximately \$0.3M of services. All work is completed within budget and schedule. The following summarizes our responsibilities:*

- Commercial and Residential Professional Service Experience: JPI staffs the contract typically with one daily inspector throughout the life of the contract. In addition, JPI provides remote commercial and multi-family residential plan review as needed by the City to target a ten-day turnaround for reviews. JPI utilizes hard tickets to complete inspections with a brief daily AM meeting in the office. Completes residential and commercial inspections and plans review.
- Firm and Staff Contract Experience: JPI provides both inspection and plans review services during the contract. All full-time staff on the contract are fully licensed as Engineers, Architects, or Building Code professionals and complete multi-trade assignments. **JPI provides licensed commercial and residential plan reviewers (multi-trade) and provides licensed commercial and residential inspectors (multi-trade).**
- Costs: JPI provides a daily 25-50% cost savings to the City through the use of multi-trade professionals. JPI covered vacation leave for City personnel on routine occasions. There were no change orders.



5) **City of Clermont - Mark A. Grenier, CBO, MCP, 352.241.7311**

SCOPE: Commercial and Residential Building Inspection & Plans Review Services

DATE OF SERVICE: 2019- Current. *Two contract renewals.*

RESPONSIBILITIES: *Joe Payne, Cory Brockett, Tony Murphy, Rick Hoepner, Mark Thornbloom, Luke Curtis, and Scott Seigel have worked on this contract. 2019 to current status – Approximately \$0.5M of services. All work is completed within budget and schedule. The following summarizes our responsibilities:*

- Commercial and Residential Professional Service Experience: JPI staffs the contract with up to three daily inspectors throughout the life of the contract. JPI provides weekly staffing schedules for Mr. Spears and Mr. Grenier. JPI provides daily results to Mr. Spears and as needed Mr. Colvin and Ms. Roderick. JPI works under eTrackit and related technologies by CRW systems/ Superion.
- Firm and Staff Contract Experience: JPI completes multi-trade residential and commercial inspections. All full-time staff on the contract are fully licensed as Engineers, Architects, or Building Code professionals and complete multi-trade assignments. **JPI provides licensed commercial and residential inspectors (multi-trade) and has staff available for licensed commercial and residential plan reviewers (multi-trade).**
- Costs: JPI provides a daily 50% cost savings to the City through the use of multi-trade professionals. For example, JPI professionals are licensed for both residential and commercial work and could have one professional handle both in a route, rather than needing two professionals. There were no change orders.



6) **Hillsborough County** – David M. Anthony, Chief Mechanical Inspector, 813-335-7570

SCOPE: Multi-trade Inspection Services and Plans Examination Services.

DATE OF SERVICE: 2016- Current. *Three contract renewals.*

RESPONSIBILITIES: *Joe Payne, Jason Steele, Daniel Folwell, Pat Nolan, Michael Tew, and Julie Daniels have worked on this contract. 2016 to current status – Approximately \$6.0M of services. All work is completed within budget and schedule. The following summarizes our responsibilities:*

- Commercial and Residential Professional Service Experience: JPI staffs the contract with up to twelve daily building inspectors throughout the life of the contract. In addition, JPI provides two in-house plan review professionals as needed by the County to target a ten-day turnaround for reviews. Completes residential and commercial inspections and plans review.
- Firm and Staff Contract Experience: All full-time staff on the contract are fully licensed as Engineers, Architects, or Building Code professionals and complete multi-trade assignments. **JPI provides licensed commercial and residential plan reviewers (multi-trade) and provides licensed commercial and residential inspectors (multi-trade).**
- Costs: JPI provides staffing to the County to meet high volume demand. JPI is the primary vendor on this contract. There were no change orders.





## 7) City of Largo – Matt Butler, CBO, 727-586-7488

SCOPE: Multi-trade Inspection Services and Plans Examination Services

DATE OF SERVICE: 2019- Current. *Two contract renewals.*

RESPONSIBILITIES: *Joe Payne, Luke Curtis, Jon Thomas, and Robert Peck, have worked on this contract. 2019 to current status – Approximately \$0.3M of services. All work is completed within budget and schedule. The following summarizes our responsibilities:*

- Commercial and Residential Professional Service Experience: JPI staffs the contract typically with one daily inspector on call through the life of the contract. JPI uses a tablet to receive and enter results and has on occasion used a hard ticket system. Completes residential and commercial inspections and plans review.
- Firm and Staff Contract Experience: JPI provides both inspection and plans review services during the contract. All full-time staff on the contract are fully licensed as Engineers, Architects, or Building Code professionals and complete multi-trade assignments. **JPI provides licensed commercial and residential plan reviewers (multi-trade) and provides licensed commercial and residential inspectors (multi-trade).**
- Costs: JPI provides a daily 25-50% cost savings to the City through the use of multi-trade professionals. JPI covered vacation leave for City personnel on routine occasions. There were no change orders.



## 8) City of South Pasadena – Terri Sullivan, CBO, 727-343-4192

SCOPE: Multi-trade Inspection Services and Plans Examination Services

DATE OF SERVICE: 2022- Current. *Sole source vendor.*

RESPONSIBILITIES: *Joe Payne, Luke Curtis, Jon Thomas, and Robert Peck, have worked on this contract. 2022 to current status – Approximately \$0.1M of services. All work is completed within budget and schedule. The following summarizes our responsibilities:*

- Commercial and Residential Professional Service Experience: JPI staffs the contract typically with one daily inspector on call through the life of the contract. JPI uses a hard ticket system. Completes residential and commercial inspections and plans review.
- Firm and Staff Contract Experience: JPI provides both inspection and plans review services during the contract. All full-time staff on the contract are fully licensed as Engineers, Architects, or Building Code professionals and complete multi-trade assignments. **JPI provides licensed commercial and residential plan reviewers (multi-trade) and provides licensed commercial and residential inspectors (multi-trade).**
- Costs: JPI provides a daily 25-50% cost savings to the City through the use of multi-trade professionals. JPI covered vacation leave for City personnel on routine occasions. There were no change orders.



## 9) City of Palm Bay - *Valentino Perez, CBO, 321-726-5614* (expanded reference description)

SCOPE: Interim Building Official and Multi-trade Inspection Services and Plans Examination Services. Public Works Services.

DATE OF SERVICE: 2016- *Current. **Three contract renewals.***

RESPONSIBILITIES: *Joe Payne, David Wilcox, Kevin Singley, Andrew Manero, Pete Swarr, Scott Seigel, Abraham Chabab, and Jorge Cedeno have worked on this contract. 2016 to current status – Approximately \$2.2M of services. All work is completed within budget and schedule. The following summarizes our responsibilities:*

- Commercial and Residential Professional Service Experience: JPI staffs the contract with up to eight daily inspectors throughout the life of the contract. In addition, JPI provides an in-house and remote plan review as needed by the City to target a ten-day turnaround for reviews. JPI utilizes HTE Mars, Naviline, BlueBeam, and Central Square on tablets and in the office. Completes residential and commercial inspections and plans review. On most days, JPI is the senior in-house plans reviewer and also responds to desk questions.
- Firm and Staff Contract Experience: JPI provides an Interim CBO on three separate occasions during the life of the contract. All full-time staff on the contract are fully licensed as Engineers, Architects, or Building Code professionals and complete multi-trade assignments. JPI provides licensed engineers and licensed CFMs for floodplain work. JPI staff also possess multiple cross-discipline licenses including stormwater pollution prevention. **JPI provides licensed commercial and residential plan reviewers (multi-trade) and provides licensed commercial and residential inspectors (multi-trade).**
- Costs: JPI provides a daily 50% cost savings to the City through the use of multi-trade professionals. For example, JPI professionals are licensed for both residential and commercial work and could have one professional handle both in a route, rather than needing two professionals. JPI provides a 40% cost savings as the interim building official through providing a work plan that isolated 24 hours per week of work that required a CBO license from 16 hours per week of administrative work within the CBO office. There were no change orders.



## 10) **City of Titusville** - *Steve Adams, CBO, 321.567.3982*

SCOPE: Commercial and Residential Building Inspection & Plans Review Services

DATE OF SERVICE: 2017- *Current. **Two contract renewals.***

RESPONSIBILITIES: *Joe Payne, Mark Thornbloom, Cory Brockett, Rick Hoepner, and Scott Seigel have worked on this contract. 2017 to current status – Approximately \$0.4M of services. All work is completed within budget and schedule. The following summarizes our responsibilities:*

- Commercial and Residential Professional Service Experience: JPI staffs the contract with up to three daily inspectors throughout the life of the contract. JPI provides weekly staffing schedules to Mr. Adams and Mr. Abel. JPI attended a daily 730am meeting to receive a hard ticket route and emailed results daily.
- Firm and Staff Contract Experience: JPI completes multi-trade residential and commercial inspections. All full-time staff on the contract are fully licensed as Engineers Architects or Building Code professionals and complete multi-trade assignments. **JPI provides licensed commercial and residential inspectors (multi-trade) and had staff available for licensed commercial and residential plan reviewers (multi-trade).**
- Costs: JPI provides a daily 50%-75% cost savings to the City through the use of multi-trade professionals. For example, JPI professionals are licensed for both residential and commercial work and could have one professional handle both in a route, rather than needing two professionals. There were no change orders.



# Joseph Payne PE, MBA

## Curriculum Vitae

### Credentials

Professional Engineer  
Florida License #55751  
Georgia License #33995  
Delaware License #15439 (inactive status)

### Corporate Office

5995 S A1A  
Melbourne, FL 32951

### Mailing Address

16057 Tampa Palms Blvd. , #242  
Tampa, FL 33647

### Phone

Cell: 813.731.1501

### Internet

E-mail: [joe@jpiflorida.com](mailto:joe@jpiflorida.com)

### Education

Masters of Business Administration  
University of South Florida, Tampa, Florida

Bachelor of Science in Civil Engineering  
Drexel University, Philadelphia, Pennsylvania

Graduate studies (Geotechnical Engineering- 1998)  
New Jersey Institute of Technology, Newark, New Jersey

### Continuing Education:

Florida Department of Financial Services (Neutral Evaluation) –2013  
Florida Department of Financial Services (Mediation) - 2014  
Florida Civil Circuit Court Mediator - (Pending 2014)  
1802 Wind Hazard Mitigation Training – April 2011  
Advanced MOT Work Zone – 2005  
Amtrak Contractor Safety Training - 1999  
OSHA 40 Hour Hazwoper – 1997

---

### Professional Associations

Florida Board of Professional Engineers, Case Reviewer  
Hillsborough County Plumbing Board of Adjustment, Appeals and Examiners (Engineer)  
Hillsborough County Land Use Appeals Board (2009-2010)  
Westchase Association Board of Directors (2007-2009)

## **Areas of Concentration**

Municipal Services  
Quality Assurance and Control Manager  
General Civil/ Site Engineering  
Public Sector Market Development  
Environmental Resource Permitting  
Pond Siting Reports  
D.O.T. Drainage Connection Permits  
Public Meetings

---

## **Professional Experience**

### ***Joe Payne Inc., Tampa, FL 2009-current***

#### **President**

President of a full service civil engineering firm. Owner and Principal-In-Charge of three service lines (Municipal Service Line, Civil/Site Engineering, and State/ Federal). Consultant for thirty-five municipalities in the State of Florida. Provide professional opinions and consultation. Within the Municipal Service Line, common activities include Interim Building Official coverage, Residential and Commercial plan review (office and remote), and Residential and Commercial Inspector (paper based and tablet). Quality Control Officer for JPI.

Consultant for the Florida Board of Engineers. Complete plan reviews and provide professional opinions for complaint cases involving building code, sinkhole, site plans, inspections, and related professional activities. Provide professional opinions.

Consultant for the Florida Department of Financial Services. Engineering and Financial Management consultation.

Completed neutral evaluation for Department of Financial Services for sinkhole loss verifications and remediation methods. Cases in Hillsborough, Hernando, Pasco, Highlands, and other counties throughout Florida.

### ***Louis Berger Group, Inc., Florida Statewide, 2013-2014***

#### **Special Consultant – Contract Role**

Consultant for Louis Berger Group Florida Statewide marketing and business development pursuits. Project Manager for several Design-Build pursuits with a large international Design-Build contractor in South Florida. Project Manager for pursuits along SR 826 and HEFT. Proposal Manager for the Louis Berger team on the I-4 Ultimate P3 project. Proposal Manager for the Interstate Program Manager pursuit and Emergency Response General Consultant pursuits for FDOT.

### ***Greenhorne & O'Mara, Clearwater, FL 4/08 to 8/09***

#### **Project Director**

Worked as a Project Manager and Technical Director for a nationally ranked general civil and transportation consulting firm located in Tampa Bay. Project Manager for professional service contracts in the one million to three million dollar range. Won the

Hillsborough County TTF-2a contract at Broadway and Falkenburg which was the first Hillsborough County public works contract at the office. Closed FDOT Design-Build contracts for work in FDOT 2. Brought in construction permitting and dewatering contracts for work in Collier County. Set-up teaming agreements for contracts for FDOT Design-Build projects and shortlisted on D4 work. Project Director for Hillsborough County Public Works contracts. Assists the Office Manager in reaching \$2.5 million dollar sales goal for public sector clients, primarily City, County, and alternate bid FDOT projects. Corporate restructuring led me to pursue a new home to continue my career.  
*References: Matt Fabrizio (Frmr. Project Manager), 727.423.0202*

***TY Lin, Inc., Tampa, FL 7/05 to 4/08***

Associate/ Project Manager

Project Manager and Technical Lead Drainage Engineer for the Tampa Business Unit of an international structural and transportation engineering firm. Won the Hillsborough County General Civil Service contract for the office. Brought in several FDOT 1 DEMO assignments under prior contracts. Shortlisted on several Districtwide Drainage contracts and invited by FDOT 1 to present for them at the 2007 FICE conference. Project Manager for DOT reconstruction and County intersection improvement projects. Senior Drainage Engineer on multi-lane widening, new construction, and reconstruction highway projects. Engineer of Record for engineering work associated with Water Management District permitting of stormwater management facilities. Responsible for conformance to the FDOT Drainage Design Policy and the State of Florida regulatory standards and statutes. Senior Quality Control and Quality Assurance official for the Tampa Business Unit's Roadway Drainage Design activities. Represent clients at formal and informal Public Meetings.

*Reference: John Darling (Frmr. Office Manager) 813.205.4623*

***American Consulting Engineers of Fla, Inc., Land O' Lakes, FL 4/04 to 7/05***

Senior Drainage Engineer/ Project Manager

Statewide Drainage Engineer for a national transportation engineering firm. Senior Drainage Engineer on multi-lane widening, new construction, and reconstruction highway projects. Engineer of Record for work associated with Water Management Districts. Project Manager for City and County municipal projects with construction costs under one million dollars. Represented clients at formal and informal Public Meetings. Pursued and won several CDD contracts. Considered ownership opportunities until TYLIN approached me with a more affordable stock ownership plan.

*Reference: John Kilgore (Office Manager) 813.927.0061*

***Coastal Engineering, Inc., Brooksville, FL 3/03 to 4/04***

Assistant Director

Assistant Director for a privately owned site and civil engineering firm. Won and closed approximately an average of \$25-50k of contracts per week with private clients during a very "hot" development market. Directed a 15 member technical staff completing residential and commercial construction plans for private developers. Engineer of Record for engineering work associated with Water Management District permitting, DOT Drainage Connection Permits, DOT Driveway Connection Permits, DOT Utility Permits, DOT R/W Permits, and DOT Access Management Connection Permits. Represented clients at Public Meetings.

*Reference: Tom Mountain (Office Manager) 352.796.9423*

***Florida Department of Transportation, Tampa, 9/01 to 3/03***

Assistant District Drainage Engineer

Worked as a Lead Permit Official for D.O.T. Drainage Connection Permit Reviews. Senior Engineer for engineering services completed by the Department for public services. Represented the State at formal and informal Public Meetings. Engineer of Record for engineering work associated with Water Management District permitting of stormwater management facilities.

*Reference: Dwayne Kile (Fmr. Office Manager), 727.572.7111*

***Dames & Moore/ URS, Inc., Tampa, 7/00 to 9/01***

Senior Drainage Engineer

Received an opportunity for a full time position at Dames & Moore. Engineer of Record for Roadway Drainage Engineering services on public transportation projects. Engineer of Record for engineering work associated with Water Management District permitting of stormwater management facilities.

*Reference: Matt Fabrizio (Fmr. Project Manager), 727.423.0202*

***System One - 6/99 to 7/00***

Contract position – Drainage Engineer

Designer and Engineer for roadway drainage consultation on public transportation projects. Designer and coordinator for engineering work associated with Water Management District permitting of stormwater management facilities.

*Reference: Kevin Knudsen (Office Manager), Rob Garrigues (Fmr Supervisor) 813.289.5550*

***Frederic R. Harris, Inc., Philadelphia, PA 8/98 to 6/99***

Civil Designer

Relocated back to Philadelphia to work for a major transportation company. Civil and Transportation Designer for a national transportation and public infrastructure engineering firm. Stormwater Management Design on road widening projects.

*Reference: Timothy Gunner (Former Department Manager)*

***McNally Engineering. Oakland, NJ 4/97 to 8/98***

Project Manager

Brown Caldwell was in the process of acquiring Eckenfelder. Pursued a management opportunity with McNally Engineering for job stability. Managed the design of small site and civil engineering service contracts. Coordinated environmental permits for these activities.

*Reference: Mike McNally, Owner*

***Eckenfelder/ Brown Caldwell, Inc., Ramsey, NJ 8/95 to 4/97***

Project Designer

Civil and Environmental Designer for a waste management division of a national environmental engineering firm. Completed a six month construction quality assurance assignment for a groundwater pump, treat, and reinjection system.

*Reference: Mike Monteleone (Former Office Manager)*





Kevin Singley  
901 E Midway Rd.  
Fort Pierce, FL 34982  
772-618-0449  
[Kevin.singley@yahoo.com](mailto:Kevin.singley@yahoo.com)

### **Building Code Professional**

Accomplished and integrity driven construction professional offering over 30 years' experience as a contractor, inspector, plans examiner, and building official. Recognized as a savvy leader with strengths in construction processes, defining and implementing continuous improvement strategies.

### **JPI Palm Bay/ Fernandina Beach FL/ Okeechobee**

*Plans Examiner/ CBO*

08/2020-Present

Performs remote and in-house multi-trade plans examination.

Performs Temporary CBO coverage for Fernandina Beach and Okeechobee School Board.

03/2018 - 08/2020

### **UNIVERSAL** *Building Inspection department manager*

Managed a department of Threshold Inspectors, Building code Inspectors, Plans examiners, and Building Code administrators. Performed private provider inspections and plan review. Developed relationships with new clients and maintained relationships with existing clients. Supervised business development managers and office staff. Held monthly budget meetings and reported to senior vice president of company.

Safebuilt LLC – South Florida

01/2016 - 03/2018

*Building Official, Plans Examiner, Inspector*

Performed the duties of Building Official, Plans examiner, and Inspector for multiple clients. Most time was spent between our Okeechobee and highland beach accounts but I was sent to dozens of municipalities on temporary a basis and perform all the above duties.

St. Lucie County BOCC – Fort Pierce, FL

06/2015 - 01/2016

*Inspector*

Performed daily inspections

Indian River BOCC – Vero beach, FL

08/2014 - 06/2015

*Inspector*

Performed daily inspections



St. Lucie County School District – Fort Pierce, FL

03/2002 - 08/2014

*Inspector*

Conducted daily Building Code Inspection, Fire inspections, and fire Plan review.  
Also served as the owner's rep, supervising contractors and design professionals

*Licensures and Professional Development*

State of Florida department of business and Professional regulation Certifications:

( ALL Active)

Building Code Administrator

Standard Inspector – Building, Electrical, Mechanical, Plumbing, 1&2 Family Dwelling

Standard Plans examiner – Building, Electrical, Mechanical, Plumbing

State of Florida Fire Marshal Certifications: (not Active)

Fire Inspector I

Fire Plans Examiner

Education

Fort Pierce central High School – 1989 Graduate

U.S. Army Ordnance School – 1991 Graduate

Florida State Fire College – 2004-2008

Military Service

U.S. Army National Guard 1991-1994

Honorable Discharge- Enlistment time served

321.474.7302

Scott.Seigel@ymail.com

**Areas of Experience**

Building Inspection and Plans Reviewssss, Building Code, Mechanical Code, HVAC, Energy Savings Performance Contract (ESPC) Project Financial, Development and Implementation Strategies, Commercial, Building Controls and Field Service, Construction Management, Utility Analytics, Facilities Maintenance and Management

**EDUCATION**

Bachelor of Science, Mechanical Engineering, University of South Florida, Tampa, FL 1994

Master of Business Administration (Executive MBA Program) University of South Florida, Tampa, FL 2018

**CERTIFICATIONS**

Professional Engineer, Florida #60980; Certified Energy Manager, Association of Energy Engineers;

Commissioning Authority (CxA), AABC; LEED AP, USGBC; OPMP, ASHRAE

**Experience**

**JPI – Building Inspector / Plans Examiner** 2018-2021

◇ Multi trade building inspector/ Plans Examiner for several governmental agencies in Brevard County including the City of Titusville.

**Technical Expert - Engineering** Siemens Govt Technologies, USA 2013-2018

- Customer Service ranking has improved year over year
- Experience in balancing value propositions across multiple product portfolios
- Mentored small and disadvantaged businesses to help exceed Federal Government SDB expectations
- ◇ Provided technical expertise for Energy Conservation Measures (ECMs)
- Primary analysis included HVAC, Energy Management Control Systems (EMCS), Advanced Lighting Technologies, Cogen and Tri-gen Analysis, Water Reduction Strategies and utility structure analysis'
- Emphasis in renewable energy portfolios: solar, biomass, wind, geothermal, solar thermal, hydro, and ocean technologies.
- Final Determination for bundling of ECMs in an ESPC PA/IGA based on the SPB & finance term
- Development of technical specifications and project schedules based on project requirements as determined by the team

DOD Project Sites: NSGB, USACE, Sigonella, Naples, Rota, Bahrain, Djibouti, CCAD, Var. UMCS Projects

**Sr. Project Manager**, Sain Engineering Associates (SEA), Birmingham, AL 2009-2013

- ◇ Directed Federal Project teams across 13-time zones
- ◇ Directed more than 30 EA and Cx project teams throughout the US, Middle East and Europe encompassing more than 50MMft<sup>2</sup> with projects exceeding \$750MM. (80+ Engineers and Contractors - Direct Reports)
- ◇ Allocated resources based on contract compliance: day to day operations, scheduling, and deliverables
- ◇ Provided technical expertise for Energy Conservation Measures (ECMs)

DOD clients included GSA, US Navy, USACE, USAF, DOE, Army, ANG and Marine Corp

**Sr. Principal Engineer**, Williams-Russell & Johnson Engineers/Architects, Atlanta, GA 2009-2011 (Contract)

- ◇ Designed modified mechanical systems for \$40MM educational facility i.e. Steam, CHW, DX, & CW
- ◇ Responsible Engineer of Record for all Florida projects
- ◇ Managed General and Mechanical Contractors on all required design modifications

**Principal Engineer**, General Physics Corporation, Titusville, FL 2008-2009

- ◇ Led Design Build Team for first major modification of CCAFS/KSC underground Cryogenic gas lines since the Apollo Era
- ◇ Developed new strategic plan which expanded General Physics business development and teaming capabilities

321.474.7302

Scott.Seigel@ymail.com

- Successful JV with 8A Design Firm for City of Orlando engineered design projects (>\$10M)
- Successful JV Teaming for PAFB AFTEC (>\$180M Building)
- ◇ Engineer of Record for shovel ready project modifications across KSC, CCAFS, PAFB and Ascension Island

**Owner/President**, Easley Mechanical Services, Melbourne FL 2003–2008

- ◇ Commercial and Residential HVAC installation
- ◇ Startup company that approached \$2M in revenue after 5 years (16 direct reports)
- ◇ Produced C-Suite analytics monthly, P&L responsibilities
- ◇ Performed all annual performance reviews, hiring, training, and mentoring of Technicians
- ◇ Directed all government and commercial sales efforts
- ◇ Developed a successful inventory control method then managed the SCM processes

**Sr Facilities Engineer**, Siemens Power Corporation, Orlando FL 2000 – 2003

- ◇ Responsible for the design, analysis, and project management of multiple self-determined mechanical and electrical projects in existing office buildings, data centers and laboratories across multiple divisions and 16 buildings (2.4Mft<sup>2</sup>)
- Design Projects: Chiller Plants, Data Centers, Multiple office renovations, exterior renovation(s)
- Major Project: Major HVAC renovation of 260,000ft<sup>2</sup> headquarters building
- Major Project: Construction of (2) 4-story 180,000 ft<sup>2</sup> buildings
- ◇ Specified design criteria, discussed and select minimum equipment requirements with outside equipment manufacturers
- ◇ Produced bid packages which included architectural, mechanical and electrical drawings and specifications
- ◇ Developed strategic plans for mechanical and electrical improvements. Typical facility upgrades included HVAC, temperature controls, electrical, chemical and mechanical equipment, hazmat and fire alarm systems

**Engineering Team Lead** Raytheon Constructor, Cape Canaveral, FL 1999-2000 (Contract)

- ◇ Led Mechanical Department Engineers, Field and Technical Support for the \$250M+ Delta IV Launch Facility (Pad 37B)
- Reduced construction costs by as much as \$25M through correctly interpreting existing plans, design intent and specifications for Cryogenic piping and HVAC systems
- Supervised mechanical, electrical and specialty niche contractors

**Software Expertise**

Analytics: R, Tableau; MS Office: Excel, Word, Project, PowerPoint; Engineering Software: Carrier E-20II, CMMS, Estimation, Tracer, Energy Plus, various load calculation programs

SCOTT ERIC SEIGEL, P.E., LEED AP, C.E.M., CxA, O.P.M.P.  
Melbourne, FL



321.474.7302

Scott.Seigel@ymail.com

**Volunteer Organizational Leadership**

Executive Chairman, American Society of Mechanical Engineers, Cape Canaveral Florida Section 2000-2002

- ◇ Increased revenues 10-fold over a 12-month period
- ◇ Expanded Volunteer Executive Board from 5 members to 33 members; P&L responsibility
- ◇ Government Relations, Woman & Minorities Issues, Professional & Career Development Issues, College Relations, & Member Retention, STEM Teacher Awards, Scholarships, Publicity, and Technical Programs.
- ◇ Awarded 3 consecutive years, 2000-2002, as Best ASME Section Regionally and worldwide 2001, 2002

President, ASHRAE Space Coast Florida Chapter 2009, 2014

ASHRAE Region XII Chair, Government Activities 2014-2015

Military Experience: US NAVY Electrician

**AWARDS**

*Technical Award for Leadership* Canaveral Council of Technical Societies (CCTS)

**Extensive Travel**: 45 states and 41 countries



**SWARR, PETER C., P.E.**  
**Civil Construction Field Engineer**  
**1535 Satinwood Court, NE, Palm Bay, FL 32905**  
**(H)(321) 549-2070 (Cell) (443)-655-4982**

---

## **EDUCATION**

Lehigh University - B.S. Civil Engineering - 1982

## **REGISTRATIONS**

Registered Professional Engineer in Pennsylvania - 2004

Registered Professional Engineer in Delaware - 2004

Registered Professional Engineer in South Carolina- 2009

Registered Professional Engineer in Illinois - 1992

Registered Professional Engineer in Florida - 1991

## **EXPERTISE**

Project Management

Construction Management

Earthwork/Soils Projects

Project Controls – Cost and Schedule

Field Engineering

Owner/Client Relations

## **JPI 2017- CURRENT**

Senior Plans Reviewer and Inspector for multiple trades (building, mechanical, plumbing, and electrical trades). Utilizes tablet to enter field results in real time. Primarily work in St.Lucie County.

## **SARGENT & LUNDY RESPONSIBILITIES**

Mr. Swarr provides construction management leadership and support to Clients assisting them accomplish their project specific scope, schedule, cost, and quality objectives. During the pre-construction phase, his responsibilities include pre-construction planning, project scope development, budget and schedule preparation, bid preparation and award, and performing constructability reviews. In the construction execution phase, he monitors contractor work activities, verifies contractor schedule and work quality, assists in resolving design and installation questions, and administers construction contracts. He has capabilities to lead project teams or perform critical individual contributor role duties. He is a proficient verbal and written communicator.

## **EXPERIENCE**

- **NIPSCo – Reynolds**

**SWARR, PETER C., P.E.**  
**Civil Construction Field Engineer**  
**1535 Satinwood Court, NE, Palm Bay, FL 32905**  
**(H)(321) 549-2070 (Cell) (443)-655-4982**

---

Assigned as a field construction engineer for the Reynolds substation and the Reynolds IN to Topeka, IN transmission line. Duties include management of construction activities, overseeing foundation installation, overseeing the delivery of transformers for the project, overseeing the installation of caissons for the substation components, and overseeing clearing of the right of way. (2015 to present)

- **Duke Energy – Oconee Nuclear Power Station**

Civil Construction Field Engineer. Assigned to the Tornado/HELP and Protected Service Water Project as a Construction Implementation Engineer. During the design process, responsibilities were to provide concrete and structural-related constructability input and analysis to the Engineering Group for specific modifications. During the concrete and structural installation work, supported the Contractors leading activity to resolve Contractor field problems and initiating actions to remove barriers to Contractor installation success. (2009 to 2012). Recalled to site to expedite the drawing as-building process and to facilitate the installation of the PSW pump and associated piping system. In addition, designed various hangers required due to relocated equipment. (2013 to 2015)

- **Basin Electric Power Cooperative – Laramie River Station**

Civil Construction Field Engineer. Assigned to the Circulating Water Piping Refurbishment Project. Duties were to conduct oversight and inspections of contractor CW piping refurbishment work during the plant outage. Refurbishment work consisted of cleaning, preparation, and coating internal CW piping surfaces. During the work, prepared inspection and progress reports. (2013)

- **OPPD – Fort Calhoun Nuclear Station**

Civil Construction Field Engineer. Assigned to the Containment Internal Structures Project. Duties were to implement a concrete and structural inspection and testing program for reinforcement of reactor containment internal structures. (2013)

- **ECS Mid-Atlantic**

Senior Project Engineer. Responsible for preparation of subsurface investigations; providing design recommendations for building foundations; assessment of subsurface data from field investigations; and training of geotechnical inspection personnel. Performed third-party construction inspections including civil, structural, mechanical, electrical, plumbing, insulation, and fire protection for various projects. Supervised field technicians performing soils, concrete, and structural steel inspections. Provided construction advice to clients as to methods to solve their construction problems, such as would be encountered in utility, roadway, or building installation. Performance of property condition assessments, environmental site assessments, and asbestos surveys. Projects included deep foundations for buildings, earthwork projects, residential subdivisions, subdivision roadways, commercial facilities, and industrial facilities in the Delaware, Southeastern Pennsylvania, and Northeastern Maryland region. (2003 to 2008)

- **ASC Geosciences**

Senior Project Engineer. Responsible for preparation of subsurface investigations; providing design recommendations for building foundations; assessment of subsurface data from field investigations; and training of geotechnical inspection personnel. Supervised field

**SWARR, PETER C., P.E.**  
**Civil Construction Field Engineer**  
**1535 Satinwood Court, NE, Palm Bay, FL 32905**  
**(H)(321) 549-2070 (Cell) (443)-655-4982**

---

technicians performing soil, concrete, structural steel, masonry, and other special inspections. In addition, advised contractors as to methods to solve their geotechnical construction problems, such as would be encountered in utility, roadway, or building installation. Performance of environmental site assessments and asbestos surveys. Projects included deep foundations for buildings, residential subdivisions, subdivision roadways, and commercial facilities in the State of Florida. (2003)

- **Law & Associates**

Senior Project Engineer. Responsible for preparation of subsurface investigations; providing design recommendations for building foundations, assessment of subsurface data from field investigations, and management and training of soils, concrete, structural steel, and masonry inspection personnel. (2001 to 2002)

- **HSA Engineers and Scientists**

Senior Project Engineer. Responsible for preparation of subsurface investigations, providing recommendations for foundation design; assessment of subsurface data from field investigations; and management and training of geotechnical inspection personnel. (2000 to 2001)

- **Atlantic Testing Laboratories**

Vice President and Chief Engineer. Responsible for preparation of subsurface investigations; providing recommendations for foundation design; assessment of subsurface data from field investigations; and management and training of soils, concrete, structural steel, and masonry inspection personnel. (1993 to 2000)

- **GSC Environmental Laboratories, Inc.**

Senior Project Manager/Engineer/Asbestos Consultant. Responsibilities included: supervision of field personnel; marketing; performance of environmental assessments; technical reviews, conduction various other inspections and tests, management of field technicians. (1991 to 1993)

Project Manager. Responsible for preparation of subsurface investigations; providing recommendations for foundation design, assessment of subsurface data from field investigations, and management and training of geotechnical inspection personnel. (1989 to 1991)

- **Frederick Ward Associates**

Project Manager. Responsible for establishment of a geotechnical department; interface with clients (including contractors, governmental agencies, etc.); geotechnical recommendations; report preparation/review; training and supervising of lab and field inspectors. (1987 to 1989)

- **Robert B. Baiter Company**

Project Engineer and Inspector. Responsible for performance of inspections and tests for construction materials including soils, concrete, and structural steel; providing recommendations for shallow and deep foundation systems, and report preparation. (1985 to 1987)



**SWARR, PETER C., P.E.**  
**Civil Construction Field Engineer**  
**1535 Satinwood Court, NE, Palm Bay, FL 32905**  
**(H)(321) 549-2070 (Cell) (443)-655-4982**

---

### **SPECIFIC PROJECT EXPERIENCE**

Westbridge Apartments, Annapolis, MD - Senior Project Manager and construction inspector.

The Crescent at Fells Point, Baltimore, MD - Senior Project engineer and construction inspector

Domain Brewers Hill, Baltimore, MD - Senior Project engineer and construction inspector.

Annapolis Junction Commercial Park, MD - Senior Project engineer for inspection agency.

Wickham Road widening, Brevard County, FL - Engineer for inspection agency Dairy Road

widening, Brevard County, FL - Engineer for inspection agency.

Kennedy Space Center, several projects, including Launch Pads 39 B (Shuttle) and 41 (Titan) -  
Geotechnical engineer and Engineer for inspection agency.

Walt Disney World, Emergency Services Facility - Geotechnical Engineer.

Walt Disney World, Buena Vista Drive Re-Paving- Engineer for testing agency.

Emerald Isles Condominiums, Panama City, FL - 23 Stories, Geotechnical Engineer, pile  
inspection, threshold construction inspections.

City of Palm Bay, FL - Geotechnical engineer for roadway re-construction/upgrades City of

Melbourne, FL - Geotechnical engineer for roadway re-construction/upgrades.



# ANDREW THOMAS MANERO

1113 Blossom Drive Sebastian, FL 32958

ph 561 901 3513, email: atmanero@gmail.com

## OBJECTIVE

---

Collaborate with a team to promote Education & Awareness through the built environment.

## CERTIFICATIONS

---

**Registered Architect, AR96338**

**Interior Designer, ID6107**

**LEED BD+C**

## EXPERIENCE

---

**JPI- JOE PAYNE INC.**, Plans Reviewer/ Building Inspector, August 2017-Present

**Residential & Commercial Building Plans Reviewer (In-House) and Building Inspector**

In-house Plans Reviewer for St. Lucie County and a Treasure Coast Municipality. Commercial plans examiner for JPI for projects multi-story commercial projects and other forms of commercial projects. Review Permit Documents, Permit Applications, & Notice of Commencement on site. Apply knowledge of Building Code in field to built conditions. Verify construction is compliant with Project Documents and Building Code

**UMBER ARCHITECTURE LLC**, President, 2013-Present

**Residential & Commercial Project Architect**

Prepare Construction Documents for Submission to Authority Having Jurisdiction

Review Plans submitted by Engineers, Consultants and Contractors

Meet with Building Official and Plan Reviewer's to walk-through Complex projects

Verify project is in compliance with the Construction Documents during Construction **Projects:**

**Stratford Arms-** 10,000 square foot Condominium Communal Area Renovation, Boca Raton, FL

**Pure Vie-** 1,500 Square Foot Spa & Yoga Studio Build-Out, Sarasota, FL

**Bowen Residence-** New 5,000 Square Foot House in Lighthouse Point, FL

**Kathy's House-** New 3,200 Square Foot House in Delray Beach, FL

**Cohen Residence-** 4,000 Square Foot Condominium Renovation in Boca Raton, FL

**Kukes Residence-** 5,300 Square Foot Condominium Renovation in Boca Raton, FL

**Convissar Residence-** Residential Addition

**Swanson Residence-** Residential Site Plan

**Equestrian Way-** Residential Remodel & Addition

**LEIGHTON DESIGN GROUP**, 2013-Present

**Residential & Commercial Interior Design**

**Reviewed Plans and Construction Documents for ADA and Building Code Compliance.** Project Management, Project Design, Drafting, Scheduling, Construction Administration. Review General Contractor's Bids, for completeness.

**ANDREW T MANERO, ARCHITECT, Owner, 2012-2013**

***Residential & Commercial Architecture***

**Lupa Shoes-** Retail renovation & re-branding

Programming: Analyzed display & storage requirements, created options for new store image

Design Development: Created new floor plan, lighting layout, and display systems within budget

Construction documents: Prepared bid documents, & permit sets

**Ortega Lane-** High-end residential design/build

Reviewed design concepts with owner & implemented into working drawings

Interviewed contractors, reviewed qualifications & bids

Created construction documents for city

Supervised construction, motivated contractors to meet deadlines

**RENEWABLE LIVING INC, General Manager, 2011-2013**

***High End Interior Design/Build, Custom Fabrication & Installation***

Manage general operations, systemization, finances, payroll, and insurance, create marketing material

**Generate leads,** convert to sale, and close deals

Estimate project costs, negotiate buy-outs, purchase materials, and coordinate installations

Supervise the design & construction teams

**WEST ARCHITECTURE, Project Manager, 2010**

***Architecture & Construction***

Met project budget and time schedule

Managed Construction Documents, Engineer Coordination, & Estimating.

**Design/Build:** Plan & implement fluidity of drawings for construction to minimize changes.

**Historic Renovations:** Synchronized notes on drawings to accommodate Historic Society &, Archeological requirements with modern construction methods.

Created marketing packages for RFP's

**BALFOORT FINNVOLD ARCHITECTURE, Project Manager, 2007-2010**

***Architecture***

Coordinated construction documents with owner, consultants, & city reviewers

**LEED Projects:** Documented and managed LEED Templates

Estimated and analyzed costs of materials, systems and finishes

Edited and assembled the Project Manual and Specifications

**Custom Homes:** Met with homeowners to, present select finishes and approve drawings, make sure the homeowner understood the drawings and was always satisfied

Created and presented 3d walkthroughs with selected finishes to homeowners

Completed projects on schedule in accordance with Housing Department requirements and secure permit from the Building Department

**Contract Administration:** Lead pre-bid & pre-construction meetings, observed job sites during construction administration, and approved pay applications

Addressed and problem solved building issues during construction

**GLAVOVIC STUDIO INC, Project Manager, 2005-2006**

***Architecture, Urban Planning***

**Site Feasibility Report for Miami Beach:** Systematically investigated site conditions, and current user groups

Developed conceptual design based on City Master Plan

Investigated precedents and interviewed potential users for a skate plaza

Compiled findings into a final document and Power Point presentation  
Client extended contract for further consideration of project

### **ARCHITECTURAL DIMENSIONS**, Drafter, 2004-2005

#### ***Architecture***

**Retail Stores:** Gap Inc/ Old Navy/ Banana Republic

Worked with the project team to complete construction documents.

Administered quality control for drafting team.

### **ARCHITECTURAL INTERIORS OF SOUTH FLORIDA**, Designer/ Drafter, 2001-2003

#### ***Interior Design***

The Village of Merrick Park, Motorola, ATI Technical School

As build drawings, Construction Documents, Rendering.

### **ACADEMICS**

---

Florida Atlantic University, Bachelor of Architecture 2006

### **SKILLS**

---

Accela Inspector

Masterspec software

Sketchup, Realistic Renderings

Auto CAD 2D and 3D

Adobe: Photoshop, Illustrator, In Design, Acrobat

Microsoft: Word, PowerPoint, Moviemaker, Outlook, Excel

QuickBooks



## GENERAL INFORMATION

JPI has vast experience with plan review of applications within tourism areas. This primarily comes from our vast clientele in St. Lucie County and coastal areas through Florida. We find that key factors in plan review for visitor tourism and marketing are as follows:

- 1) Historic Preservation
- 2) Signage
- 3) Accessibility
- 4) Review schedules

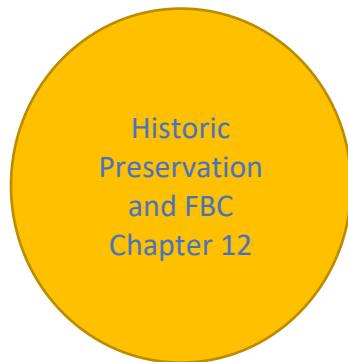

Historic Preservation is a key building code activity for tourism in Florida. Our tourism quite often features Historic buildings which are popular for local tourism and out of town tourism. Preservation supports federal funding also for the project to maintain the building in its historic state. FBC Chapter 12 provides Code on Historic Buildings. The intent is to provide means for occupant safety, property conservation and use of designated historic buildings while protecting those elements, spaces and features that make these buildings historically or architecturally significant.

Signage beautifies tourism areas and provides marketing platforms for communities. Appendix H Signs of the Florida Building Code provides Code on the erection of signs. Chapter 31 discusses special construction. Other sections also discuss signage. NEC 2017 provides lighting Code for signage.

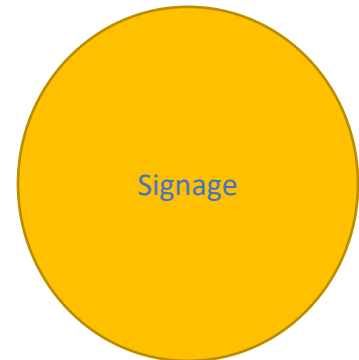

One key factor of the Building Code which affects marketing and tourism is accessibility. JPI completes a thorough accessibility review of sidewalks, access, corridor widths and lobbies of common areas. Tourism and marketing projects provide future tax revenues, so with cash flow, always comes the importance of schedule, specifically plan review schedules. These projects may receive priority plan reviews due to the stakeholders involved in the community.

JPI completed plan reviews on a variety of projects over the years with our clientele involving marketing and tourism. Here are three examples:



- 1) St. Lucie County. St Lucie County has an Office of Tourism which we interface with on key projects. One example, is that JPI has completed plan reviews and other professional services at hangers within the Treasure Coast International Airport.
- 2) Clearwater, FL. JPI has completed plan reviews and inspections for a variety of new high-rise hotels in Clearwater and Clearwater Beach, FL. The most recent project is the Alanik Hotel in Clearwater Beach, FL which broke ground in 2023.
- 3) Fernandina Beach. Fernandina Beach Main Street is regulated by the National Trust for Historic Preservation. Demolition within most commercial building in this area is limited to what is allowable the Preservation. These restrictions far surpass the Building Codes for certain work, as Preservation is the key goal.



## CERTIFICATES

JPI provides DBPR and sunbiz.org certificates. Also, we provide a summary table of our employee licensure.

<u>JPI</u>	<u>DBPR</u>	<u>Years Exp</u>
Joe Payne	FLPE55751	30
Greg Perlin	BN6576	40
Jack McCabe	BN4613	50
Jason Steele	FLPE69234	20
Cory Brockett	FLPE74677	20
Bob Hightower	BN2430	40
Doug Walton	AR0007045	50
Andrew Chupka	FLPE46655	40
Juan Mastrapa	FLPE68217	30
Greg Martin	BN3947, PX1848	40
John Wiggins	BN2384	40
Andrew Mareno	AR96338	20
Eddie Page	FLPE69045	30
Pete Swarr	FLPE44159	40
Ezz Elgayar	BN6415	40
Robert Bryce	PX2783	45
Scott Seigel	FLPE60980	30
Luke Curtis	RPX279, PX3717, BN6614, BU1975	30
Andrew West	FLPE60301	30
Dan Folwell	BN6927	40
Charles M. Nolan	FLPE19889	45
Rick Hoepner	FLPE23319	50
Ryan Ferry	BN6617	15
Mark Thornbloom	FLPE50107	35
Jon Thomas	BN7125	15
Glenn Hall	PX3588, BN5324	50
Kevin Singley	PX3601, BN4798, BU1872	30
Micheal Tew	PX2675, BN5003	30
Tony Murphy	AR100424	35
Robert Peck	BN7567	40
James Crouch	BN8698	40



[Department of State](#) / [Division of Corporations](#) / [Search Records](#) / [Search by Entity Name](#) /

## Detail by Entity Name

Florida Profit Corporation  
JOE PAYNE, INC.

### Filing Information

**Document Number** P10000059808  
**FEI/EIN Number** 80-0640420  
**Date Filed** 07/21/2010  
**State** FL  
**Status** ACTIVE

### Principal Address

5995 S HIGHWAY A1A  
MELBOURNE BEACH, FL 32951

Changed: 06/28/2021

### Mailing Address

5995 S HIGHWAY A1A  
MELBOURNE BEACH, FL 32951

Changed: 02/09/2022

### Registered Agent Name & Address

PAYNE, JOSEPH  
5995 S Highway A1a  
MELBOURNE BEACH, FL 32951

Address Changed: 01/23/2022

### Officer/Director Detail

#### **Name & Address**

Title DPST

PAYNE, JOSEPH  
5995 S Highway A1a  
MELBOURNE BEACH, FL 32951

### Annual Reports

<b>Report Year</b>	<b>Filed Date</b>
2021	01/11/2021



2022                    01/23/2022  
2023                    01/19/2023

**Document Images**

<a href="#"><u>01/19/2023 -- ANNUAL REPORT</u></a>	View image in PDF format
<a href="#"><u>01/23/2022 -- ANNUAL REPORT</u></a>	View image in PDF format
<a href="#"><u>01/11/2021 -- ANNUAL REPORT</u></a>	View image in PDF format
<a href="#"><u>01/28/2020 -- ANNUAL REPORT</u></a>	View image in PDF format
<a href="#"><u>02/14/2019 -- ANNUAL REPORT</u></a>	View image in PDF format
<a href="#"><u>01/21/2018 -- ANNUAL REPORT</u></a>	View image in PDF format
<a href="#"><u>01/10/2017 -- ANNUAL REPORT</u></a>	View image in PDF format
<a href="#"><u>07/07/2016 -- ANNUAL REPORT</u></a>	View image in PDF format
<a href="#"><u>01/20/2015 -- ANNUAL REPORT</u></a>	View image in PDF format
<a href="#"><u>04/19/2014 -- ANNUAL REPORT</u></a>	View image in PDF format
<a href="#"><u>04/27/2013 -- ANNUAL REPORT</u></a>	View image in PDF format
<a href="#"><u>04/12/2012 -- ANNUAL REPORT</u></a>	View image in PDF format
<a href="#"><u>04/11/2011 -- ANNUAL REPORT</u></a>	View image in PDF format
<a href="#"><u>07/21/2010 -- Domestic Profit</u></a>	View image in PDF format

THE OFFICIAL SITE OF THE FLORIDA DEPARTMENT OF BUSINESS & PROFESSIONAL REGULATION



Florida **dbpr** Department of Business & Professional Regulation

[HOME](#) [CONTACT US](#) [MY ACCOUNT](#)

## ONLINE SERVICES

- [Apply for a License](#)
- [Verify a Licensee](#)
- [View Food & Lodging Inspections](#)
- [File a Complaint](#)
- [Continuing Education Course Search](#)
- [View Application Status](#)
- [Find Exam Information](#)
- [Unlicensed Activity Search](#)
- [AB&T Delinquent Invoice & Activity List Search](#)

## LICENSEE DETAILS

11:50:56 AM 6/1/2023

### Licensee Information

Name:	<b>JOE PAYNE, INC. (Primary Name)</b>
Main Address:	<b>5995 S HIGHWAY A1A MELBOURNE BEACH Florida 32951</b>
County:	<b>BREVARD</b>

### License Information

License Type:	<b>Engineering Business Registry</b>
Rank:	<b>Registry</b>
License Number:	<b>29882</b>
Status:	<b>Current</b>
Licensure Date:	<b>04/24/2012</b>
Expires:	

### Special Qualifications

### Qualification Effective

--

### Alternate Names

--

[View Related License Information](#)

[View License Complaint](#)

---

2601 Blair Stone Road, Tallahassee FL 32399 :: Email: [Customer Contact Center](#) :: Customer Contact Center: 850.487.1395

The State of Florida is an AA/EEO employer. **Copyright 2007-2010 State of Florida. Privacy Statement**

Under Florida law, email addresses are public records. If you do not want your email address released in response to a public-records request, do not send electronic mail to this entity. Instead, contact the office by phone or by traditional mail. If you have any questions, please contact 850.487.1395. \*Pursuant to Section 455.275(1), Florida Statutes, effective October 1, 2012, licensees licensed under Chapter 455, F.S. must provide the Department with an email address if they have one. The emails provided may be used for official communication with the licensee. However email addresses are public record. If you do not wish to supply a personal address, please provide the Department with an email address which can be made available to the public. Please see our **Chapter 455** page to determine if you are affected by this change.



[Previous on List](#) . [Next on List](#) . [Return to List](#)

Fictitious Name Search

[Filing History](#).

Submit

## Fictitious Name Detail

### Fictitious Name

JPI

### Filing Information

**Registration Number** G15000008007  
**Status** ACTIVE  
**Filed Date** 01/23/2015  
**Expiration Date** 12/31/2025  
**Current Owners** 1  
**County** HILLSBOROUGH  
**Total Pages** 4  
**Events Filed** 3  
**FEI/EIN Number** 80-0640420

### Mailing Address

5995 S HIGHWAY ALA  
 MELBOURNE BEACH, FL 32951

### Owner Information

JOE PAYNE, INC.  
 5995 S HIGHWAY ALA  
 MELBOURNE BEACH, FL 32951  
**FEI/EIN Number:** 80-0640420  
**Document Number:** P10000059808

### Document Images

[01/23/2015 -- REGISTRATION](#)

View image in PDF format

[02/07/2022 -- CHANGE NAME/ADDRESS](#)

View image in PDF format

[05/27/2021 -- CHANGE NAME/ADDRESS](#)

View image in PDF format

[01/12/2020 -- Fictitious Name Renewal Filing](#)

View image in PDF format

[Previous on List](#) . [Next on List](#) . [Return to List](#)

Fictitious Name Search

[Filing History](#).

Submit



## **FINANCIAL DATA**

JPI's Dunn and Bradstreet number is 039948949. If necessary, we will submit our 1120 tax forms as proprietary during the selection process.



## SCOPE OF WORK

Our Approach to the Scope of Work is based on our sound knowledge of Building Code Review from our statewide contracts. There are several key factors of measurement for the success of the Approach to the Scope of Work. From our experience, JPI found that the citizen and contractor end user's needs are best met through four key factors:

- 1) Current knowledge
- 2) Consistency
- 3) Code references
- 4) Quality Control

### 4 KEY FACTORS

Current knowledge  
Consistency  
Code references  
Quality Control

JPI is the sole source vendor for the St. Lucie County Building and Code Regulation

Current knowledge is a key factor for this work. JPI possesses technical staff who are subject matter experts in plan review. Through our current work with plan review, JPI maintains knowledge of Technical Bulletins, Code Advisories, and Code Updates. JPI possesses this knowledge in both residential and commercial construction and in all trades. From feedback that we receive from our current clientele, our commercial plan review is very thorough with code references and cross reference to NFPA and other codes. JPI has

worked with St. Lucie County since 2018 and is familiar with how to interact with the local builder community.

The second key factor is Consistency. Specifically, with the Pass/Fail rate of our work for statistical significance to the City employees. This establishes consistency between resources and provides consistency to the citizens of Fort Pierce. The contractor community is sensitive to a new plan reviewer creating review comments unseen regularly in the community. JPI proposes to initially contact the Building Division with our proposed comments prior to posting to the applicant. JPI possesses several standard comment files, with code references, that we can share with the Building Division.



**Click2Gov**

JPI possesses permitting software knowledge through our past and current work. We are familiar with the main screen which lists the active reviews in que. As an on-call provider, JPI provided professional services for all trades including electrical, mechanical, building, and plumbing trade professionals. JPI is different from our competitors because of our availability of multi-trade staff and the personal touch of the Owner, Mr. Payne, who will leave the office and assist clients with plan review services. **Mr. Payne regularly reviews plans for Mr. McCloud.** JPI is a 100% Florida Based company with 100% of our employees residing and working in Florida.

Our notice period to provide staffing ranges from **five minutes** to five days. When the City provides five days of notice, JPI will typically serve these requests 100 percent of the time. When the City provides 24 hours of notice, JPI will typically serve these requests 90 percent of the time. When the City calls us in the morning of the day requiring plan review, we still can meet this request with a 50 percent reliability, by having local staff and the ability of the Owner Mr. Payne, to leave the office and service contracts “hands-on”.

JPI will provide all equipment necessary for this work and has done so as an incumbent. JPI employees maintain FBC, NEC, NFPA, ICC and other related code references as they complete their work. For plan review, 30 full-time equivalents, FTE’s, can perform plan review with at least 10 FTEs per trade available (due to multi-trade licensure). JPI has four licensed building officials available for this contract and twenty licensed professional engineers.



**The third key factor is Code References.** JPI proposes a **WORK Plan** unique to the services listed within this RFP. Our **WORK Plan** will consider all regulatory Codes for this Work Objective. The 2020 FBC, Mechanical, 7<sup>th</sup> edition will regulate policy for HVAC systems. The 2010 ADA will regulate the ADA inspections along with Accessibility Code. The 2020 FBC including the Existing Conditions Chapter, will regulate building code compliance, doors and hardware, fences, structural aspects of Fireplaces & Chimney, Insulation, Roofing Systems, Seawalls, Docks,

and Structural Components. Florida Elevator Code Authority and FBC Chapter 30 (over three stories) regulates elevators. NFPA 70 regulates fire protection and co-regulated NEC 2017 and 2020. ASCE 7-16 regulates wind loads. The Energy Code is an overlapping regulation. Solar Energy Code is regulated in several locations including Chapter 23 of the Residential Code and Chapter 14 of the Mechanical Code, and the Florida Plumbing Code. FBC Chapters 4 and 45 regulate swimming pools and saunas. The Florida Plumbing Code regulates plumbing systems, plumbing and pool heaters, and the Gas

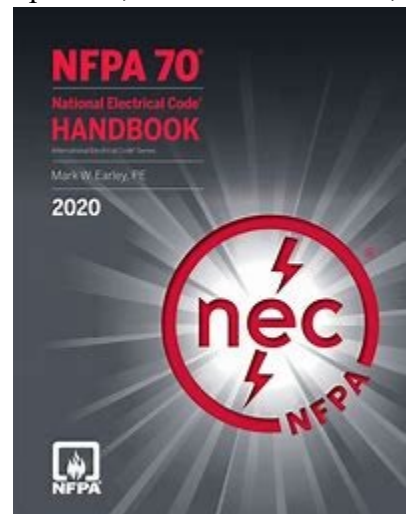



Code regulates gas pool heaters. Additional Code considerations within our Operational Plan include NFIP, NPDES, ACOE, FAA47CFR, and [FAA107 for the developing Drone technologies for roof inspections](#).

Continuing with this **WORK Plan**, JPI will input the daily plan review results in a timely fashion. JPI professionals will utilize individual emails and direct phone numbers to communicate with City constituents. JPI has multi-trade professionals who will review and process construction plans for issuance of building permits under the Florida Building Code. JPI will enforce other agency submittals including FEMA, Driveway permit, and FDEP. JPI will maintain records of work conveniently through creating a pdf of the results. JPI will enforce the 50/50 rule for substantial improvements for FEMA on projects and review and maintain all records required by Federal Emergency Management Agency (“FEMA”) in association with the processing of building permits in the format required by FEMA. JPI will maintain all records and documents in accordance with Public Records Law (Chapter 119, Florida Statutes) and using the current General Records Schedule GS1-SL (For State and Local Government Agencies) which includes the GS6 (For Building Departments). This expands to include code enforcement of hazards, nuisances, and violations. JPI’s multi-trade professionals and licensed engineers will assist in the preparation of the Insurance Services Office (ISO) evaluation for the City.

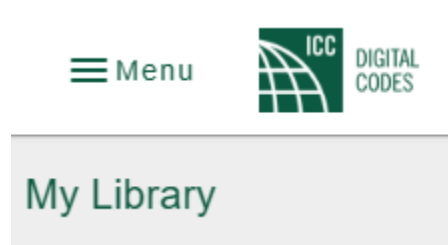

JPI Professionals possess OSHA Level D attire with JPI logo shirts. In the office, JPI professionals will dress in business casual with JPI logo shirts. JPI personnel have smart phones with mobile hotspots and Bluetooth for ease of Wi-Fi and platform access. In addition, JPI personnel utilize Ipads which contain training and continuing education software. All JPI Building Code Professionals receive

continuing education for license renewals. Engineers receive continuing education bi-annually for license renewals as do Registered Architects. JPI has a digital subscription to the ICC digital library and as continuing education all employees reference a digital subscription of the Florida Building Code in their practice along with the use of ICC code check books.

JPI will initially utilize staff already located locally. Joe Payne is the Project Manager. JPI is a statewide firm staffed with a TEAM ORGANIZATION of 40 professionals. Our company’s operational capacity is 1800 hours per week. Currently, we are running at approximately 1400 hours per week billable which is our current and projected workload. We have up to 400 hours per week of surplus capacity available to service this contract. This is approximately ten full-time equivalents. We are operating at 77.78% capacity with 22.22% availability to support our WORK PLAN.

JPI’s **EXPERIENCE** includes successful and practical work on similar projects. JPI currently serves numerous similar agencies including St. Lucie County, Martin County, Brevard County,



City of Stuart, and previously, Indian River County. JPI has a proven track record of excellent customer service, and the City may contact any of our references to verify the same. JPI will perform the duties of the Plan Examiner to accept and review plans, issue permits, perform inspections, issue certificates of occupancy and perform other Florida Building Code and City Code duties.

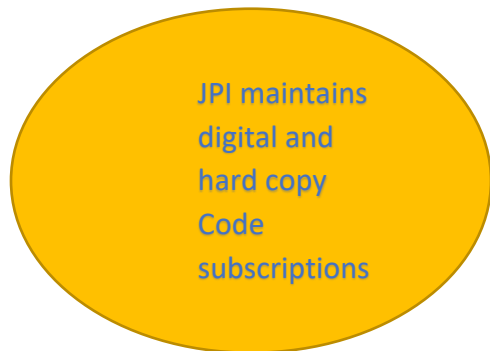

JPI has a full access digital subscription to the ICC website which provides digital access to current and prior editions of the Florida Building Code. In addition, our staff possesses handbooks on tablets and smartphones (with mobile hotspots) which provide convenient access to Code references. The **TEAM MANAGEMENT** of JPI includes a quality control program for new contracts, and staff, which includes mentoring and shadow/ over the shoulder training. Joe Payne, PE is the **TEAM PROJECT MANAGER** and **regularly monitors the**

**pass/fail rate of our inspections.**

The SDE is a tool to help local officials administer the Substantial Damage requirements of their floodplain management ordinances in keeping with the minimum requirements of the NFIP.

FEMA is a key plan review and inspection subject matter that interfaces with ROW, Zoning, Site, Habitat, Environmental, and all services under this RFP. The monitoring of FEMA substantial improvements is imperative. Key activities fall under Flood Damage Reduction, however, also consider public information (elevation certificates). The Zoning activities under this RFP dovetail into Mapping and Regulations and Flood Damage Reduction. This contract supports Warning and Response activities by filing in for City operations during Emergency Management situations such as named Hurricane Storms. Public Information Activities mainly consist of elevation certificates. This begins at the plan review level when the reviewer checks for the FEMA base flood elevation and design flood elevation. FEMA Technical Bulletin 10-01, page 7, Figure 2 is a key

resource when reviewing foundation construction in the floodplain.

The City floodplain manager provides Map Information Services and Hazard Disclosures to the Community. We presume that under this current RFP, that JPI will interface with hazard disclosures through the ROW field investigation work. JPI will utilize available City GIS system data for Flood Protection Assistance and Flood Insurance Promotion. The Zoning and Habitat service under this contract will support Mapping and Regulations. Habitat supports Open Space Preservation.





The goal of these efforts is to develop into Flood Damage Reduction. Floodplain Management Planning is a goal of the Zoning reviews. The ROW services under this contract will support Acquisition and Relocation services. Flood proofing is a concept regulated in efforts to provide flood protection. Flood vents, flood proofing materials below the Design Flood Elevation, raising electrical panels to elevations above the DFE, are all examples of Flood Protection activities. Site Inspections will support Drainage System Maintenance. Our services provide support to the City for Warning and Response activities. When City employees need to enter communities to complete damage assessment, for example, JPI staff backfill the Division and complete their inspection and plans examination for that period of time.

JPI utilizes several forms of QAQC in their work. See examples

**A fourth key measuring factor for this work is Quality Control.** JPI’s Quality Control process starts with Day 1 for the employee. JPI has a shadowing program, and employees have over the shoulder shadow training for the first two weeks. This is a progressive training approach in which the over the shoulder time decreases daily over the two weeks. Also, we conduct audits of work for employees and randomly have shadow oversight. The employee is informed in the morning that JPI will oversee their work that day. For plan review and

office work, JPI completes work from Code Review checklists. JPI feels that it is best to depict checklists used for our work to emphasize that work. The following are examples of Quality Control processes and procedures utilized for work under this contract.



Date: \_\_\_/\_\_\_/\_\_\_

Permit Number: \_\_\_\_\_

**2020 Plan Review Guideline (SFR)**  
Based on Florida Building Code 7th Edition (2020)

Living SF: \_\_\_\_\_ Non-Living SF: \_\_\_\_\_ Total SF: \_\_\_\_\_ Bedrooms: \_\_\_\_\_ Bathrooms: \_\_\_\_\_ Stories: \_\_\_\_\_

Insulation/efficiency: AC \_\_\_\_\_ Heat: \_\_\_\_\_ Roof: \_\_\_\_\_  Porch  Gas

- Consistent square footage calculations on construction plans and zoning permit FBC 107.2.6
- Consistent approved plot plan and construction plans FBC 107.2.6
- FL product approval sheet for all exterior materials FBC 107.2.4
- Energy calculations FBC EC R101.5
- Form 405-2020
  - Signed by preparer and owner/agent
  - Has pass seal
  - Conditioned floor are matches living area on plans
  - Attic Vented  Attic Unvented
  - Insulation matches wall sections on construction plans
  - Water heater  (Gas)  (Electric)
- Manual J FBC EC R403.7
  - Consistent with Manual S
  - Equipment information notated
- Manual S FBC EC R403.7
  - Total capacity equal to or greater than 100% and less than or equal to 115% (or closest available unit size)
- Duct layout FBC EC R403
  - Consistent with construction plans (flipped ducts layouts are unacceptable)
  - Duct sizes, CPM, and return/supply Or
  - Manual D

- General Construction Plan Requirements**
- Paper Plans FAC 61G15-23, 61G1-16
    - Original hand signature and wet or raised seal from a licensed Florida design professional
  - Digital Plans FAC 61G15-23, 61G1-16
    - Unlocked digital signature capable of verification and a seal from a licensed Florida design professional on the first page
  - Plans dimensioned and scaled
  - Plans legible (minimum text size 3/32") LCC Ch.6
  - Plans designed to the 2020 Florida Building Code Residential and all other applicable codes

- Structural**
- Wind zone location or wind speed FBC R301.2.1
  - Exposure category FBC R301.2.1.4
  - Design loads FBC R301
  - Components and cladding pressures for openings FBC R609.2
  - Lumber grade and species FBC R502, 602, and 802
  - Fasteners used with P.T. wood FBC R317.3
  - Lintel designation FBC R608.8.2

- Foundation Plan**
- Slab description (thickness and compressive strength) FBC R402.2 and 506
  - Minimum 6-mil polyethylene or approved vapor retarder FBC 506.2.3
  - Soil bearing value FBC R401.4
  - Termite treatment FBC R318
  - Sloped garage floors to main door FBC R309.1
  - Footing dimensions and location FBC R403.1.4
  - Isolated/Column footing dimensions and location
  - Stem/retaining wall height

- Floor Plan**
- Square foot tabulation (living/nonliving)
  - 1 exterior swing door to be minimum 3'x6'-8" FBC R311.2
  - Hazardous glass locations indicated as "Temp." or "Safety" (Within 2' of doors, bath or pool areas within 5' with a sill below 5", stairs with sill below 3", within 5' of bottom of stairs with sill below 3") FBC R308.4
  - Solid or 20 min fire rated door from garage to dwelling FBC R302.5.1
  - 1/2" gypsum or better on garage wall side of dwelling separation FBC R302.6
  - 5/8" type x gypsum on garage ceiling if habitable room above FBC Table R302.6
  - 1 bath/toilet room with a 29" minimum clear access, on the lower floor FBC R320
  - Sleeping rooms have E.E.R.O/Egress Opening FBC R310.2
  - Attic access location (minimum 22x30 and all separate areas with 30" height clearance) FBC R807
  - Hallways minimum 3' wide FBC R311.6
  - Rooms labeled and uses identified

- Elevation Plan**
- All elevations
    - Dimensioned
  - Windowsills minimum height FBC R312.2.1
  - Roof vent calculations if required on Form 405-2020 FBC R806
  - Crawlspace ventilation and access (if applicable) FBC R408
  - Roof slope FBC R905
  - Roof material FBC R904
  - Location of vented appliance/fireplace (if applicable) FBC R G2427
  - Egress windowsills maximum height FBC R310.2.2

- Truss Plan**
- Signed and sealed by design professional of record FBC R802.10
  - Strapping locations FBC 107
  - Truss bracing FBC R802.10.3
  - Connector chart specifying the type, size, and number of fasteners FBC 107
  - Gable end details (if applicable) FBC R602
  - Truss plans consistent with elevations FBC 107

- Electric Plan**
- Electric layout FBC 107 per NEC 2017
  - Smoke alarms FBC R314
    - In each sleeping area
    - Outside each sleeping area
    - On each dwelling floor
  - Carbon monoxide alarms (if applicable) (within 10ft of sleeping rooms) FBC R315

- Details**
- Stair construction details indicate minimum 10" tread and 3/4" - 1 1/4" nosing, maximum 7.75" riser height, 6'-8" headroom height, 36" wide/deep landings at top and bottom, handrail location, 34"-38" handrail/guardrail heights, and maximum 4" open rail spacing FBC R311.7
  - Guards at porches, balconies, open stairs, ramps, raised floor more than 30" need guards: 34" at stairs and ramps, 36" all other areas FBC R312.1
  - Show fire protection (minimum 1/2" gypsum board) under stairs FBC R302.7
  - Bearing/Sheer/Opening/Header construction/details FBC 107
  - Wall section(s) from foundation through roof to include wall assembly of interior and exterior materials FBC R301
  - Frame walls have 2 layers of water-resistant barriers FBC R703.7.3
  - Chimney/Fireplace Details FBC R1001
  - Manufacturer specifications for factory-built fireplaces FBC R1005
  - Wall sheathing with nailing pattern indicated FBC R604
  - Roof sheathing with nailing pattern indicated FBC R803
  - Wood sill plate anchoring to foundation FBC R403.1.6, 602
  - Header and connection details for exterior and/or bearing walls FBC R602.7
  - Dormer framing details FBC 107
  - Provide gas layout FBC R G 2413
  - Provide soffit detail FBC R704



The following is a standard checklist for a condo remodel/ renovation similar to Plan Examining Commercial - Remodel Multi-Trade (all trades) Review in the rate sheet:

### CONDO KITCHEN/BATH RENOVATION

**NOTICE:** Effective January 1, 2023, a smoke alarm that is newly installed or replaces an existing battery-powered smoke alarm must be powered by the condo electrical system with a back-up battery that powers the alarm for at least 10 years. The battery requirements do not apply to a fire alarm, smoke detector, smoke alarm, or ancillary component that is electronically connected as part of a centrally monitored or supervised alarm system.

- I. Fire Protection
  - a. Fire Sprinkled? Y  or N  (If yes, show on plans)
  - b. Fire Alarm? Y  or N  (If yes, show on plans)
  - c. Show existing & proposed location for new or relocated fire sprinklers/fire alarms/smoke detectors/strobes/horns, etc.
  - d. State if smoke alarms are hardwired and /or interconnected. FBC 420, NFPA 72 & NFPA 13

II. Type of Construction (per FBC Ch. 6): **Check One**

Type I:   
Concrete & steel  
High-rise tower

Type II:   
Masonry & steel  
Mid & low-rise

Type III:   
Masonry & steel  
Wood roof or floor  
Mid & low-rise

Type V:   
Wood frame  
Construction  
Low-rise

\*Metal stud construction  
Fire treated wood

Wood Stud Construction  
Allowed

III. Show Floor Plans:  
Existing space

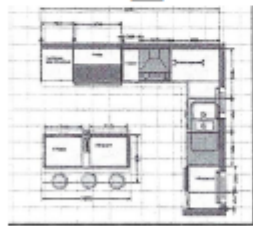

Proposed space



Basic overall condo layout



- IV. Indicate scope of work for:
  - a. HVAC: Relocated supply/RA or exhaust duct
  - b. PLBG: Relocated or new fixtures ~ provide Plbg ISO
  - c. ELEC: New/altered GFCI circuits ~ provide panel schedule

V. Replacing tile/wood flooring? Sound underlayment ~ Minimum 50 STC impact IIC rating required per (2020) Florida Building Code (FBC) 7<sup>th</sup> Edition, Section 1207

VI. Any change to the fire rated corridor, tenant 1hr wall, or penetration of wall or floor **ATTACH UL DETAIL.**



The following is a Solar Project Review checklist:

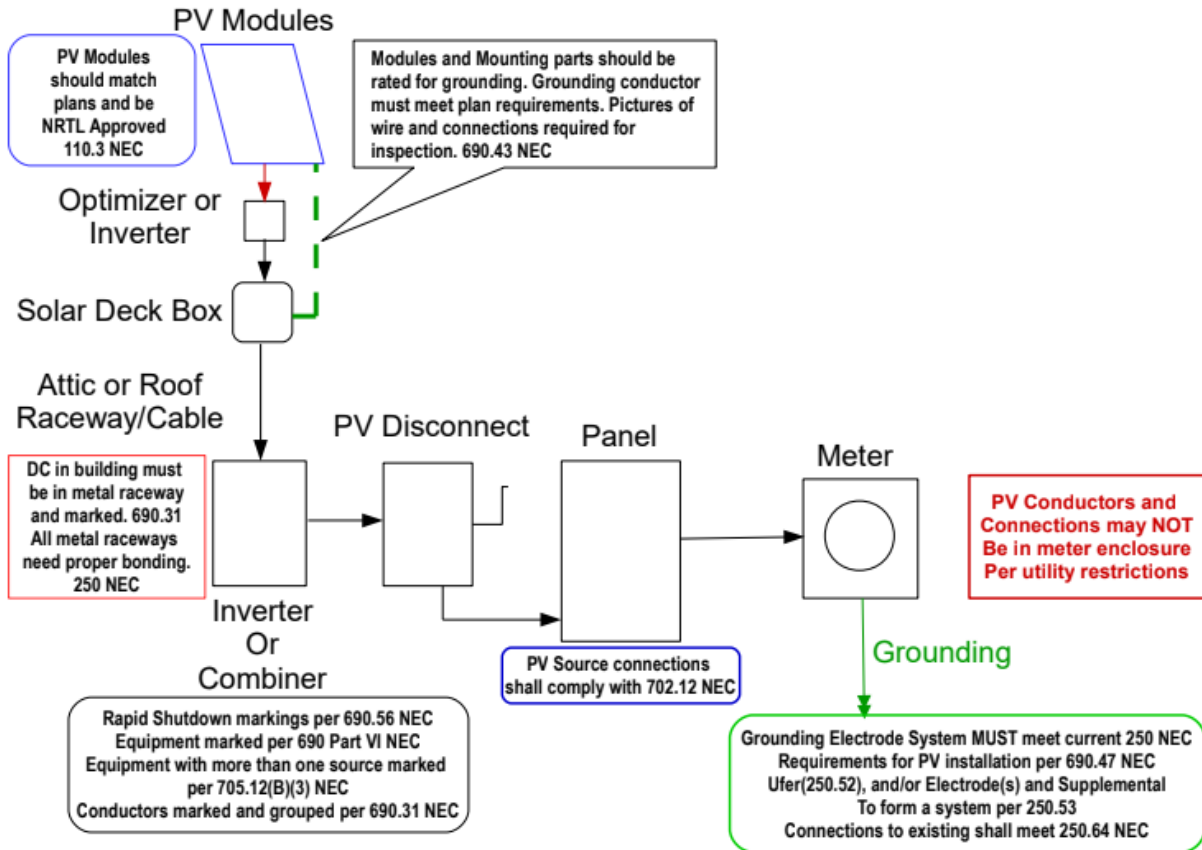



## **ADDITIONAL DATA**

JPI has completed Building Official, Plans Review, and Inspection services for St. Lucie County since 2018. We encourage the City to contact Monica Graziani at St Lucie County for reference.

# **SECTION VI**

# **STANDARD FORMS**

---

**The forms listed in this section are to be complete and submitted with your proposal.**



## DRUG~FREE WORKPLACE FORM

The undersigned vendor in accordance with Florida Statute 287.087 hereby certified that  
JPI \_\_\_\_\_ does:

*(Name of Business)*

1. Publish a statement notifying employees that the unlawful manufacture, distribution, dispensing, possession, or use of a controlled substance is prohibited in the workplace and specifying the actions that will be taken against employees for violations of such prohibition.
2. Inform employees about the dangers of drug abuse in the workplace, the business policy of maintaining a drug-free workplace, any available drug counseling, rehabilitation, and employee assistance programs, and the penalties that may be imposed upon employees for drug abuse violations.
3. Give each employee engaged in providing the commodities or contractual services that are proposed a copy of the statement specified in subsection (1).
4. In the statement specified in subsection (1), notify the employees that, as a condition of working on the commodities or contractual services that are under Bid, the employee will abide by the terms of the statement and will notify the employer of any conviction of, or plea of guilty or nolo contendere to, any violation of Chapter 893 or of any controlled substance law of the United States or any state, for a violation occurring in the workplace no later than five (5) days after such conviction.
5. Impose a sanction on, or require the satisfactory participation in a drug abuse assistance or rehabilitation program if such is available in the employees community, by any employee who is so convicted.
6. Make a good faith effort to continue to maintain a drug-free workplace through implementation of this section.

As the person authorized to sign the statement, I certify that this firm complies fully with the above requirements.

*Joseph Payne*

\_\_\_\_\_  
*Proposer's Signature*

06.05.23

\_\_\_\_\_  
*Date*

# Request for Taxpayer Identification Number and Certification

Give Form to the requester. Do not send to the IRS.

▶ Go to [www.irs.gov/FormW9](http://www.irs.gov/FormW9) for instructions and the latest information.

**1** Name (as shown on your income tax return). Name is required on this line; do not leave this line blank.  
Joe Payne, Inc.

**2** Business name/disregarded entity name, if different from above  
JPI

**3** Check appropriate box for federal tax classification of the person whose name is entered on line 1. Check only **one** of the following seven boxes.

Individual/sole proprietor or single-member LLC

C Corporation

S Corporation

Partnership

Trust/estate

Limited liability company. Enter the tax classification (C=C corporation, S=S corporation, P=Partnership) ▶ \_\_\_\_\_

**Note:** Check the appropriate box in the line above for the tax classification of the single-member owner. Do not check LLC if the LLC is classified as a single-member LLC that is disregarded from the owner unless the owner of the LLC is another LLC that is **not** disregarded from the owner for U.S. federal tax purposes. Otherwise, a single-member LLC that is disregarded from the owner should check the appropriate box for the tax classification of its owner.

Other (see instructions) ▶ \_\_\_\_\_

**4** Exemptions (codes apply only to certain entities, not individuals; see instructions on page 3):

Exempt payee code (if any) \_\_\_\_\_

Exemption from FATCA reporting code (if any) \_\_\_\_\_

*(Applies to accounts maintained outside the U.S.)*

**5** Address (number, street, and apt. or suite no.) See instructions.  
5995 s a1A

**6** City, state, and ZIP code  
Melbourne Beach FL 32951

**7** List account number(s) here (optional)

Requester's name and address (optional)

## Part I Taxpayer Identification Number (TIN)

Enter your TIN in the appropriate box. The TIN provided must match the name given on line 1 to avoid backup withholding. For individuals, this is generally your social security number (SSN). However, for a resident alien, sole proprietor, or disregarded entity, see the instructions for Part I, later. For other entities, it is your employer identification number (EIN). If you do not have a number, see *How to get a TIN*, later.

**Note:** If the account is in more than one name, see the instructions for line 1. Also see *What Name and Number To Give the Requester* for guidelines on whose number to enter.

**Social security number**

				-				-				
--	--	--	--	---	--	--	--	---	--	--	--	--

**or**

**Employer identification number**

8	0	-	0	6	4	0	4	2	0
---	---	---	---	---	---	---	---	---	---

## Part II Certification

Under penalties of perjury, I certify that:

- The number shown on this form is my correct taxpayer identification number (or I am waiting for a number to be issued to me); and
- I am not subject to backup withholding because: (a) I am exempt from backup withholding, or (b) I have not been notified by the Internal Revenue Service (IRS) that I am subject to backup withholding as a result of a failure to report all interest or dividends, or (c) the IRS has notified me that I am no longer subject to backup withholding; and
- I am a U.S. citizen or other U.S. person (defined below); and
- The FATCA code(s) entered on this form (if any) indicating that I am exempt from FATCA reporting is correct.

**Certification instructions.** You must cross out item 2 above if you have been notified by the IRS that you are currently subject to backup withholding because you have failed to report all interest and dividends on your tax return. For real estate transactions, item 2 does not apply. For mortgage interest paid, acquisition or abandonment of secured property, cancellation of debt, contributions to an individual retirement arrangement (IRA), and generally, payments other than interest and dividends, you are not required to sign the certification, but you must provide your correct TIN. See the instructions for Part II, later.

**Sign Here** Signature of U.S. person ▶ *Joseph Payne* Date ▶ 1.23.23

## General Instructions

Section references are to the Internal Revenue Code unless otherwise noted.

**Future developments.** For the latest information about developments related to Form W-9 and its instructions, such as legislation enacted after they were published, go to [www.irs.gov/FormW9](http://www.irs.gov/FormW9).

## Purpose of Form

An individual or entity (Form W-9 requester) who is required to file an information return with the IRS must obtain your correct taxpayer identification number (TIN) which may be your social security number (SSN), individual taxpayer identification number (ITIN), adoption taxpayer identification number (ATIN), or employer identification number (EIN), to report on an information return the amount paid to you, or other amount reportable on an information return. Examples of information returns include, but are not limited to, the following.

- Form 1099-INT (interest earned or paid)

- Form 1099-DIV (dividends, including those from stocks or mutual funds)
- Form 1099-MISC (various types of income, prizes, awards, or gross proceeds)
- Form 1099-B (stock or mutual fund sales and certain other transactions by brokers)
- Form 1099-S (proceeds from real estate transactions)
- Form 1099-K (merchant card and third party network transactions)
- Form 1098 (home mortgage interest), 1098-E (student loan interest), 1098-T (tuition)
- Form 1099-C (canceled debt)
- Form 1099-A (acquisition or abandonment of secured property)

Use Form W-9 only if you are a U.S. person (including a resident alien), to provide your correct TIN.

*If you do not return Form W-9 to the requester with a TIN, you might be subject to backup withholding. See What is backup withholding, later.*





## REFERENCES

### RFP NO. 2023-039 ANNUAL CONTRACT FOR PLAN REVIEW SERVICES

Proposers shall submit as a part of the bid package, two (2) Customer references with name of the customer, address, contact person, and telephone number.

<b>Name</b> St. Lucie County	<b>Name</b> City of Palm Bay
<b>Contact:</b> Monica Graziani	<b>Contact:</b> Val Perez
<b>Address:</b> 2300 Virginia Avenue Fort Pierce, FL 34982	<b>Address:</b> 190 Malabar Rd Ste 105, Palm Bay, FL
<b>Telephone:</b> 772.462.1599	<b>Telephone:</b> 321.952.3400 x 5887
<b>Email:</b> grazianim@stlucieco.org	<b>Email:</b> valentino.perez@palmbayflorida.org
<b>Name</b> City of Melbourne	
<b>Contact:</b> Steve Innes	
<b>Address:</b> 900 E. Strawbridge Ave. Melbourne, FL 32901	
<b>Telephone:</b> 321.608.7929	
<b>Email:</b> Steve.Innes@mlbfl.org	

**PROPOSAL PRICING FORM**  
**RFP NO. 2023-039 ~ ANNUAL CONTRACT FOR PLAN REVIEW SERVICES**

The following proposal(s) is submitted on behalf of: JPI for the requested services, in accordance with the agreements and specifications contained in RFP No. 2023-039.

We have carefully examined that this proposal package and understand the provisions, terms, and conditions concerning the equipment, materials, supplies or services as called for. With full knowledge and understanding of the requirements in the Proposal Package, We hereby agree to furnish and deliver services as indicated at the prices quoted herein as follows:

**NOTE:** All price columns must be completed. Where indicated, provide pricing for demolition including the removal of slabs (including slabs) and pricing in instances where slabs remain and are not removed (excluding slabs).

ITEM	DESCRIPTION	HOURLY RATE
1	<ul style="list-style-type: none"> <li>• <u>Perform plan review services.</u></li> <li>• Per Inspector: Approximately 8 hours per day, 37.5- 40 hours per week.</li> </ul>	<b><u>BLDG, M,E, or P</u></b>
		<b>1 + 2 Family</b>
		<b>Multi</b>
2	<ul style="list-style-type: none"> <li>• Full-Time Plan Reviewer</li> <li>• Perform plan review services.</li> <li>• Per Plan reviewer: In excess of 40 hours per week.</li> </ul>	\$ 82 per hour
		<b>1 + 2 Family</b>
		\$ 82 per hour
3	<ul style="list-style-type: none"> <li>• Perform plan review services.</li> <li>• Per Plan Reviewer: 4 hours per day, 18 – 22 hours per week.</li> </ul>	\$ 82 per hour
		<b>1 + 2 Family</b>
		\$ 82 per hour
4	<ul style="list-style-type: none"> <li>• <u>Perform plan review services.</u></li> <li>• <u>Pre Plan Reviewer On an needed basis</u></li> <li>• As needed Plan Review</li> </ul>	\$ 82 per hour
		<b>1 + 2 Family</b>
		\$ 82 per hour

# CITY OF FORT PIERCE PROPOSER'S CHECKLIST

This checklist is provided to assist each Proposer in the preparation of their bid response. Included in this checklist are important requirements, which is the responsibility of each Proposer to submit with their response in order to make their response fully compliant. This checklist is only a guideline, it is the responsibility of each Proposer to read and comply with the Invitation to Bid in its entirety.

**Check "Yes" or "No" to each of the following:**

	<b>YES</b>	<b>NO</b>
Is Request for Proposal cover page (page 1) completed, signed and attached?	<u>  X  </u>	<u>      </u>
Include proof of proper licensing as stated in proposal documents.	<u>  X  </u>	<u>      </u>
Include proof of proper insurance as stated in proposal documents.	<u>  X  </u>	<u>      </u>
Did you include a list of all materials and equipment to be used in providing the service?	<u>  X  </u>	<u>      </u>
Is Drug-Free Workplace form signed and enclosed?	<u>  X  </u>	<u>      </u>
Proposal envelope is marked accordingly	<u>  X  </u>	<u>      </u>
Are two (2) complete proposal packages included (one original and one electronic copy (PDF) on a USB Flash Drive) of sealed proposals?	<u>      </u>	<u>  X  </u>
Disregard, if you are going to utilize the electronic submission option.	<u>  X  </u>	<u>      </u>
Is each Addendum (when issued) signed and included?	<u>  X  </u>	<u>      </u>

**PLEASE SIGN AND RETURN WITH PROPOSAL** \_\_\_\_\_ *Joseph Payne*

JPI acknowledges all addenda

*Joseph Payne*

06.05.23



# CERTIFICATE OF LIABILITY INSURANCE

DATE (MM/DD/YYYY)

3/17/2023

THIS CERTIFICATE IS ISSUED AS A MATTER OF INFORMATION ONLY AND CONFERS NO RIGHTS UPON THE CERTIFICATE HOLDER. THIS CERTIFICATE DOES NOT AFFIRMATIVELY OR NEGATIVELY AMEND, EXTEND OR ALTER THE COVERAGE AFFORDED BY THE POLICIES BELOW. THIS CERTIFICATE OF INSURANCE DOES NOT CONSTITUTE A CONTRACT BETWEEN THE ISSUING INSURER(S), AUTHORIZED REPRESENTATIVE OR PRODUCER, AND THE CERTIFICATE HOLDER.

**IMPORTANT:** If the certificate holder is an **ADDITIONAL INSURED**, the policy(ies) must have **ADDITIONAL INSURED** provisions or be endorsed. If **SUBROGATION IS WAIVED**, subject to the terms and conditions of the policy, certain policies may require an endorsement. A statement on this certificate does not confer rights to the certificate holder in lieu of such endorsement(s).

<b>PRODUCER</b> Straight-Line Insurance, LLC 1301 Grasslands Blvd., Suite 100 Lakeland, FL 33803  www.straightlinellc.com	<b>CONTACT NAME:</b> Straight-Line Insurance, LLC <b>PHONE (A/C. No. Ext):</b> 863-904-4776 <b>E-MAIL ADDRESS:</b> info@straightlinellc.com	<b>FAX (A/C. No.):</b>
	<b>INSURER(S) AFFORDING COVERAGE</b>	
<b>INSURED</b> Joe Payne, Inc JPI 5995 S Hwy A1A Melbourne Beach FL 32951	<b>INSURER A:</b> Certain Underwriters at Lloyd's of London	<b>NAIC #</b> 32727
	<b>INSURER B:</b> Infinity Auto Insurance Company	11738
	<b>INSURER C:</b> Insurance Company of the West (ICW)	27847
	<b>INSURER D:</b> Burlington Insurance Company	23620
	<b>INSURER E:</b>	
	<b>INSURER F:</b>	

**COVERAGES**

CERTIFICATE NUMBER: 73468209

REVISION NUMBER:

THIS IS TO CERTIFY THAT THE POLICIES OF INSURANCE LISTED BELOW HAVE BEEN ISSUED TO THE INSURED NAMED ABOVE FOR THE POLICY PERIOD INDICATED. NOTWITHSTANDING ANY REQUIREMENT, TERM OR CONDITION OF ANY CONTRACT OR OTHER DOCUMENT WITH RESPECT TO WHICH THIS CERTIFICATE MAY BE ISSUED OR MAY PERTAIN, THE INSURANCE AFFORDED BY THE POLICIES DESCRIBED HEREIN IS SUBJECT TO ALL THE TERMS, EXCLUSIONS AND CONDITIONS OF SUCH POLICIES. LIMITS SHOWN MAY HAVE BEEN REDUCED BY PAID CLAIMS.

INSR LTR	TYPE OF INSURANCE	ADDL INSD	SUBR WVD	POLICY NUMBER	POLICY EFF (MM/DD/YYYY)	POLICY EXP (MM/DD/YYYY)	LIMITS
D	<input checked="" type="checkbox"/> COMMERCIAL GENERAL LIABILITY <input type="checkbox"/> CLAIMS-MADE <input checked="" type="checkbox"/> OCCUR  GEN'L AGGREGATE LIMIT APPLIES PER: <input type="checkbox"/> POLICY <input checked="" type="checkbox"/> PRO-JECT <input type="checkbox"/> LOC OTHER:	<input checked="" type="checkbox"/>	<input checked="" type="checkbox"/>	738BG02358-03	4/7/2023	4/7/2024	EACH OCCURRENCE \$1,000,000 DAMAGE TO RENTED PREMISES (Ea occurrence) \$100,000 MED EXP (Any one person) \$5,000 PERSONAL & ADV INJURY \$1,000,000 GENERAL AGGREGATE \$2,000,000 PRODUCTS - COMP/OP AGG \$ Included \$
B	<input type="checkbox"/> ANY AUTO <input type="checkbox"/> OWNED AUTOS ONLY <input type="checkbox"/> SCHEDULED AUTOS <input checked="" type="checkbox"/> HIRED AUTOS ONLY <input checked="" type="checkbox"/> NON-OWNED AUTOS ONLY <input checked="" type="checkbox"/> Allowed Autos	<input checked="" type="checkbox"/>	<input checked="" type="checkbox"/>	509-82007-3557-001	6/18/2022	6/18/2023	COMBINED SINGLE LIMIT (Ea accident) \$1,000,000 BODILY INJURY (Per person) \$5,000 BODILY INJURY (Per accident) \$100,000 PROPERTY DAMAGE (Per accident) \$ EXCESS COVERAGE \$100,000
D	<input type="checkbox"/> UMBRELLA LIAB <input checked="" type="checkbox"/> OCCUR <input checked="" type="checkbox"/> EXCESS LIAB <input type="checkbox"/> CLAIMS-MADE DED RETENTION \$	<input checked="" type="checkbox"/>	<input checked="" type="checkbox"/>	HFF0012529-3	4/7/2023	4/7/2024	EACH OCCURRENCE \$2,000,000 AGGREGATE \$2,000,000 \$
C	<b>WORKERS COMPENSATION AND EMPLOYERS' LIABILITY</b> ANY PROPRIETOR/PARTNER/EXECUTIVE OFFICER/MEMBER EXCLUDED? (Mandatory in NH) If yes, describe under DESCRIPTION OF OPERATIONS below	Y/N <input checked="" type="checkbox"/> Y <input type="checkbox"/> N	N/A	WFL 5054011 03	3/6/2023	3/6/2024	<input checked="" type="checkbox"/> PER STATUTE <input checked="" type="checkbox"/> OTH-ER E.L. EACH ACCIDENT \$1,000,000 E.L. DISEASE - EA EMPLOYEE \$1,000,000 E.L. DISEASE - POLICY LIMIT \$1,000,000
A	Professional Liability	<input checked="" type="checkbox"/>	<input checked="" type="checkbox"/>	PLC-01064-00	6/19/2022	6/19/2023	Per Claim/Agg: \$2,000,000 / \$2,000,000 Deductible: \$25,000

DESCRIPTION OF OPERATIONS / LOCATIONS / VEHICLES (ACORD 101, Additional Remarks Schedule, may be attached if more space is required)

Auto Liability Coverage Form - Hired Auto, Non-Owned Endorsement  
 E919 - Blanket Waiver of Transfer Rights of Recovery Against Others  
 E921 - Additional Insured - Primary and Non-Contributory

**CERTIFICATE HOLDER****CANCELLATION**

St. Lucie County BOCC  
 2300 Virginia Avenue - FL 3  
 Fort Pierce, FL 34982-5632

SHOULD ANY OF THE ABOVE DESCRIBED POLICIES BE CANCELLED BEFORE THE EXPIRATION DATE THEREOF, NOTICE WILL BE DELIVERED IN ACCORDANCE WITH THE POLICY PROVISIONS.

AUTHORIZED REPRESENTATIVE

John Nicholas Davis

© 1988-2015 ACORD CORPORATION. All rights reserved.

ACORD 25 (2016/03)

The ACORD name and logo are registered marks of ACORD

# APPENDICES

---

## **DemandStar Instructions How to use E-Bidding**