

Proposal For
Hidalgo County
Third Floor Administration Building
Remodel
Occupancy Sensor Quote
Buy Board Contract # 290-08
Vin # 383139 for the Hidalgo County

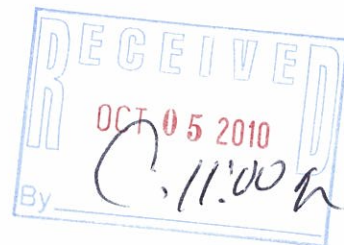

FACILITY SOLUTIONS group

October 5, 2010

Attn Rick Sunday – Hidalgo County

Reference: Old Administration building 3rd floor remodel

Buy Board Contract # 290-08 10% off trade price

	<u>Quantity</u>	<u>Sensor Type</u>	<u>Description</u>	<u>Unit Price</u>	<u>Total</u>
1.)	2	PW-100-W	WALL BOX	\$ 55.08	\$ 110.16
2.)	38	PW-200-W	WALL BOX	\$ 69.66	\$ 2,647.08
3.)	2	TS-400-W	WALL BOX	\$ 46.98	\$ 93.96

Lines 1-3 sensor price see section 4 on Buy Board contract 290-08 – 10% off trade price.

4.)	2	WPIR	CEILING	\$ 59.58	\$ 119.16
5.)	6	DT-305	CEILING	\$ 123.93	\$ 743.58
6.)	5	WT-1105	CEILING	\$ 102.87	\$ 514.35
7.)	4	WT-2205	CEILING	\$ 119.07	\$ 476.28
8.)	8	WT-2255	CEILING	\$ 119.07	\$ 952.56
9.)	25	BZ-50	CEILING P/P	\$ 27.54	\$ 688.50

Lines 4-9 sensor price see section 4 Buy Board contract 290-08 – 10% off trade price

Total bid price for sensors and power packs only will be \$ 6,345.63 – no tax

Please allow 2-3 week delivery of product.

Sincerely,



Dave Thomas



585 South Padre Island Drive > Corpus Christi, TX > 78405 > T 361-883-6833 > F 361-883-0189

Search Results:

[Help](#)

Narrow Search by Keyword(s):

Part # / Vendor	Description	Qty	Unit	Price		
Catalog Facility Solutio	10% Discount Off Watt Stopper Sensors	<input type="text"/>	EA	\$0.00	<input type="button" value="Add"/>	<input type="button" value="Info"/>
Install Facility Solutio	Installation of FSG Electric Ceiling Motion Sensor, valid for accessible layin ceiling only. Labor only, price does not include product.	<input type="text"/>	EA	\$115.00	<input type="button" value="Add"/>	<input type="button" value="Info"/>
Install Facility Solutio	Installation of FSG Electric Wall Box Motion Sensor. Labor only, price does not include product.	<input type="text"/>	EA	\$25.00	<input type="button" value="Add"/>	<input type="button" value="Info"/>
Catalog Facility Solutio	10% Discount Off Trade Pricelist for Wall Box & Ceiling Motion Sensors Click red "Info" button to see price sheet.	<input type="text"/>	EA	\$0.00	<input type="button" value="Add"/>	<input type="button" value="Info"/>

1-4 of 4 items

Search Criteria:

Vendor: Facility Solutions Group

[\[Log Out \]](#)

©1996 - 2010 TASE
ALL RIGHTS RESERVEC

Part # / Vendor	Description	Qty	Unit	Price
Catalog Facility Solutions Group	10% Discount Off Watt Stopper Sensors		EA	\$0.00

Item Information: [Vendor Website](#)

Part Number: Catalog
Reference Number: 290-08
Description: 10% Discount Off Watt Stopper Sensors
Manufacturer: Various
Vendor: Facility Solutions Group
Pkg. Weight: EA
Price: \$0.00

Extended Description:
10% Discount Off Watt Stopper Sensors

[Back](#)

[\[Log Out \]](#)

©1996 - 2010 TASB
ALL RIGHTS RESERVED

Bill of Materials Quote

Tech Support: 800-879-8585
Quotations: 800-852-2778



Quote ID: **24741**

Date: 10/5/10

Project Name: Hidalgo County - Administration Building Remodel -
Edinburg, TX

Quote Name: 3rd Flr. Revised

Notes: All recommended counts and materials should be verified before placing any orders. Verification of quantity and voltage of power packs is the responsibility of the contractor in the field and should be determined before ordering.

From Contact

Company: Watt Stopper / Legrand
Contact: Rich Crowell
Email: rich_crowell@wattstopper.com
Phone: 469-675-0183

To Contact

Agency: LONE STAR LIGHTING-SAN ANTONIO
Contact:
Email:
Phone:

Qty	Description	Catalog Number	Unit Price	Ext Price
2	PIR Wall Switch Occupancy Sensor, 120/277V, White	PW-100-W	\$61.20	\$122.40
38	PIR Wall Switch Occupancy Sensor, 2 Relays, 120/277V, White	PW-200-W	\$77.40	\$2,941.20
2	Digital Time Switch, 100-300 VAC, 0-800/1200 Watts, White	TS-400-W	\$52.20	\$104.40
2	PIR Ceiling Occ Sensor24 VDC,300 sq ft	WPiR	\$66.60	\$133.20
6	Dual Tech Occupancy Sensor24VDC, center mount 360°, 40 Khz	DT-305	\$137.70	\$826.20
5	Ultrasonic Ceiling Occupancy Sensor24 VDC, 1100 sq ft	WT-1105	\$114.30	\$571.50
4	Ultrasonic Ceiling Occupancy Sensor24 VDC, 2200 sq ft	WT-2205	\$132.30	\$529.20
8	Ultrasonic Ceiling Occupancy Sensor24 VDC, 90 linear ft	WT-2255	\$132.30	\$1,058.40
25	Power Pack, 120~277V, 50/60Hz,24VDC, 225mA	BZ-50	\$30.60	\$765.00
			Total:	\$7,051.50

Terms & Conditions: Payment Terms: Upon approved credit, the following terms apply: Net 30 from date of invoice. A 1.5% per month interest charge will apply to all past due accounts. Accounts over 30 days will be subject to a hold.
Prices: All prices are subject to change without notice. Federal, state, and local taxes, if applicable, are not included in published or quoted prices.
Quotations: All quotations, bids, contracts, and orders are subject to final written approval, or acceptance and acknowledgement by The Watt Stopper, Inc. with the condition that all noted terms and conditions apply. Quotations will be firm for sixty (60) days. Prices acknowledged on deferred or hold orders will be firm for ninety (90) days.
Minimum Order: The minimum acceptable order is \$50.00. There are no exceptions to this policy.
Notice: Please see our web site at www.wattstopper.com a full disclosure of our terms and conditions.
Transportation Charges: All prices are F.O.B. shipping point with transportation prepaid and allowed on orders of \$2,500.00 net, or more, within the continental United States.

P.O. Box 400
Austin, Texas 78767-0400
512-467-0222
800-695-2919
Fax: 800-211-5454
www.buyboard.com



**LONE STAR
LIGHTING, INC.**

Manufacturers Representative

J. Antonio Olivares
409 Nolana, Suite 4
McAllen, Texas 78504
antonio@lonestartlg.com • www.lonestartlg.com

Cell 956-821-8648
Ph. 956-631-2565
Fax 956-631-2794

March 19, 2008

Sent Via E-mail: richardh@fsg.com

Mr. Wyatt Stevenson
Facility Solutions Group (FSG)
610 W. Powell Lane
Austin, TX 78753

Dave Thomas - Division Mgr.

Proposal Name & Number: Energy Saving Lighting Products #290-08

Dear Mr. Hormuth:

Congratulations, your company has been successful on the above referenced proposal! This contract will be effective April 1, 2008.

To see the items your company has been awarded, please review the proposal tabulation #290-08 on the following website: www.vendor.buyboard.com. In addition, on this website you will find the membership list which will provide you with the names of all entities with membership in our purchasing cooperative.

Attached to this letter you will find the following documents:

- Vendor Quick Reference Sheet
- Electronic Catalog Format Instructions

Receipt of a purchase order directly from a Cooperative member is not within the guidelines of the coop. Accepting orders directly from member entities may result in a violation of the State of Texas competitive bid statute and cancellation of the proposal award. Therefore, all orders must be processed through the Cooperative in order to comply. We request your assistance in immediately forwarding by fax (1-800-211-5454) to the cooperative any orders received directly from member entities. If by chance an order sent directly to you has been unintentionally processed, please fax it to the Cooperative (1-800-211-5454) and note it as **RECORD ONLY** to prevent duplication.

Per proposal specifications, awarded vendors will have 60 days to submit their electronic catalog. If the electronic data is not provided within 60 days of notice of award, we reserve the right to inactivate any company's award information from the Buyboard until such time the electronic data is received.

On behalf of the Texas Association of School Boards, we appreciate your interest in the Cooperative and we are looking forward to your participation in the program. If you have any questions, please contact me at 512-467-0222, ext. 7154 or 1-800-695-2919.

Sincerely,

Sharon McAfee
Bid Administration Manager

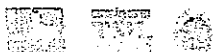

The Texas Local Government Purchasing Cooperative is a joint project of the
Texas Association of School Boards, Texas Municipal League, and Texas Association of Counties



PW-100 Passive Infrared Wall Switch Sensor

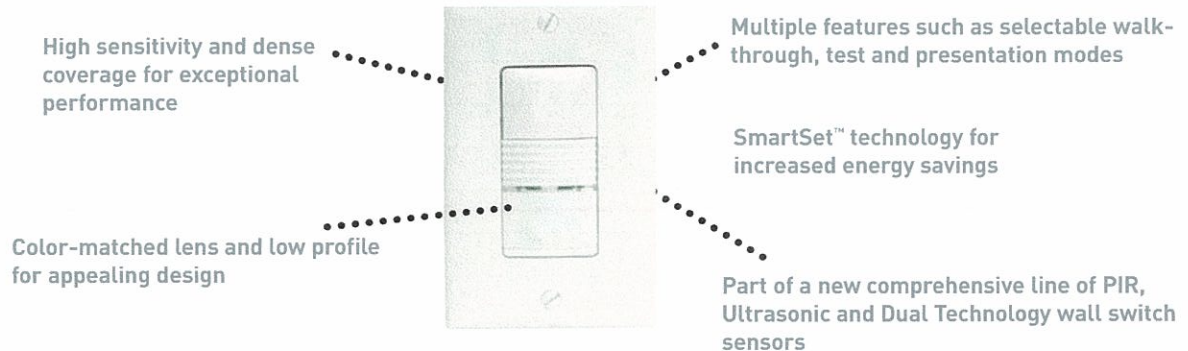

PROJECT	3rd Floor Remodel
LOCATION/TYPE	Former Administration Building

Product Overview

Description

The PW-100 passive infrared (PIR) wall switch sensor turns lights ON and OFF based on occupancy. It is characterized by high sensitivity to small and large movements, appealing aesthetics, and variety of features.

Operation

The PW-100 replaces existing wall switches and fits in a single gang junction box. It uses advanced PIR technology to detect occupancy and turns lighting ON. Once the space is vacated and the time delay elapses, lights automatically turn OFF. DIP switch settings allow for a variety of control options such as Auto-ON or Manual-ON operation, walk-through, and test modes.

SmartSet™

Using SmartSet technology, the PW-100 continuously monitors the controlled space to identify usage patterns and automatically adjust the time delay for optimal energy efficiency. The sensor assigns short delays (as low as seven minutes) for times when the space is usually vacant, and longer delays (up to 30 minutes) for busier times. SmartSet is also able to differentiate electrical noise from human motion for greater performance.

Applications

The PW-100 sensor is well suited for small, enclosed spaces with clear line of sight of the occupant. Common applications include small office, small conference room and lunch/break rooms.

Features

- Detection Signature Processing eliminates false triggers and provides immunity to RFI and EMI
- Zero-crossing for long relay life
- Vandal resistant lens combines precise coverage with durability
- Choice of Auto-ON or Manual-ON operation
- Selectable SmartSet automatically adjusts time delay for maximum savings
- Selectable walk-through mode turns lights off three minutes after the room is initially occupied if no motion is detected after the first 30 seconds
- Selectable test mode allows quick and easy adjustments
- Selectable audible and/or visual alerts for impending shutoff
- In automatic mode, sensor returns automatically to Auto-ON after lights are turned off manually; ideal for presentations
- LED indicates occupancy detection
- Features built-in light level sensing with simple, one-step setup
- Override mode allows sensor to operate as a service switch in the unlikely event of a failure
- NEMA WD 7 guideline utilized for coverage testing

Specifications

- PW-100: 120/230/277 VAC; 50/60 Hz
@ 120 VAC, 0-800 W ballast or tungsten, 1/6 hp
@ 230/277 VAC, 0-1200 W ballast
- PW-100-347: 347 VAC; 50/60Hz, 0-1500 W ballast
- Time delays: SmartSet (automatic), fixed [5, 10, 15, 20, 25 or 30 minutes], walk-through, test-mode

- Coverage: Major motion 35' x 30'
Minor motion 20' x 15'
- Sensitivity adjustment: PIR (high/low)
- Dimensions: 2.73" x 1.76" x 1.83"
[69.3mm x 44.7mm x 46.5mm] L x W x D
- UL and CUL listed; five year warranty

Controls & Settings

Product Controls

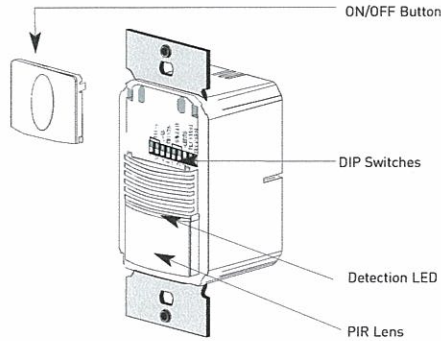

DIP Switch Settings

Time Delay	1	2	3
Auto/Test	↓	↓	↓
5 minutes	↓	↓	↑
10 minutes	↓	↑	↓
15 minutes	↓	↑	↑
20 minutes	↑	↓	↓
25 minutes	↑	↓	↑
30 minutes	↑	↑	↓
override	↑	↑	↑

Walk-Through 4
Disabled ↓
Enabled ↑

PIR Sensitivity 5
High ↓
Low, 50% ↑

Visible Alert 6
Disabled ↓
Enabled ↑

Audible Alert 7
Disabled ↓
Enabled ↑

Relay 1 Mode 8
Auto On ↓
Manual On ↑

Time Delay Visible Alerts Not Used

Walk-Through Audible Alerts PIR Sensitivity

⬆=ON ⬇=OFF ⬅=Factory Setting

Ⓞ Bypass occupancy & light level functions. Loads are manually controlled with PW-200 buttons.

Coverage & Wiring

Coverage Pattern

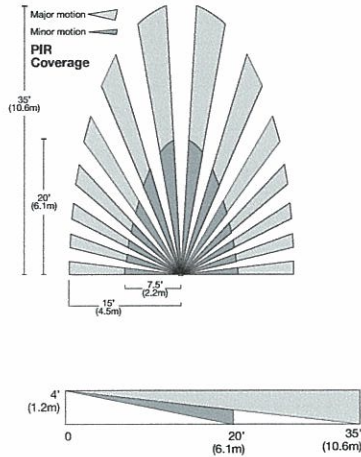

* For best performance, Watt Stopper/Legrand recommends using this sensor in spaces no larger than 15' x 12'

PW-100/347 Single Level Lighting

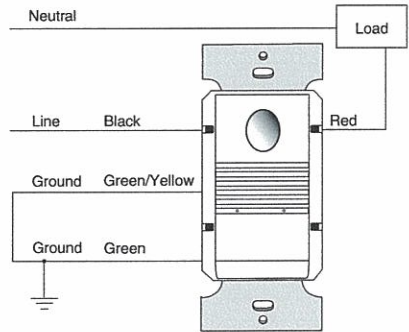

Ordering Information

Catalog No.	Color	Voltage	Load Rating
<input type="checkbox"/> PW-100-W	White	120/230/277 VAC; 50/60 Hz	@ 120 VAC, 0-800 W ballast or tungsten, 1/6 hp @ 230/277 VAC, 0-1200 W ballast
<input type="checkbox"/> PW-100-LA	Lt. Almond		
<input type="checkbox"/> PW-100-I	Ivory		
<input type="checkbox"/> PW-100-G	Grey		
<input type="checkbox"/> PW-100-B	Black		
<input type="checkbox"/> PW-100-347-W	White	347 VAC; 50/60 Hz	0-1500 Watt Ballast
<input type="checkbox"/> PW-100-347-LA	Lt. Almond		
<input type="checkbox"/> PW-100-347-I	Ivory		
<input type="checkbox"/> PW-100-347-G	Grey		
<input type="checkbox"/> PW-100-347-B	Black		

One ASP-211 single-gang cover plate included. Order ASP-422 for blank 2-gang cover plate, ASP-432 for 2-gang cover plate with switch option (specify color).





PW-200 Passive Infrared Dual Relay Wall Switch Sensor

High sensitivity and dense coverage for exceptional performance

Two relays for control of two separate lighting loads or circuits

Color-matched lens and low profile for appealing design

Selectable auto set, walk-through, test and presentation modes for increased energy savings and convenience

Part of a comprehensive line of PIR, Ultrasonic and Dual Technology wall switch sensors

PROJECT	3rd Floor Remodel
LOCATION/TYPE	Former Administration Building

Product Overview

Description

The PW-200 passive infrared (PIR) wall switch sensor turns lights ON and OFF based on occupancy. It contains two relays for controlling two independent lighting loads or circuits, and a variety of features.

Operation

The PW-200 replaces existing wall switches and fits in a single gang junction box. It uses advanced PIR technology to detect occupancy and turns lighting ON. Once the space is vacated and the time delay elapses, lights automatically turn OFF. Each of the PW-200's relays can control a separate lighting load and each can be set for either automatic or manual-ON. Dual ON/OFF buttons allow the user to manually turn on and off each of the loads. DIP switch settings allow for a variety of control options such as Auto-ON or Manual-ON operation, walk-through, and test modes.

Bi-Level Control

The PW-200 features a built-in light level sensor that controls the second (secondary) relay. If adequate daylight is present, the sensor will hold secondary lights off until daylight levels drop, providing increased energy savings. The PW-200 satisfies energy codes requiring bi-level or daylight control switching. The two relays in the sensor give it the ability to control two lighting loads independently. This provides A/B switching where the user can achieve half-lighting (or another desired portion) from a single switch.

Applications

The PW-200 sensor is well suited for small, enclosed spaces with a clear line of sight of the occupant. In addition, its dual relays allow bi-level switching or control of a secondary load. Common applications include small office, small conference room and lunch/break rooms.

Features

- Detection Signature Processing eliminates false triggers and provides immunity to RFI and EMI
- Zero-crossing on both relays for long relay life
- Vandal resistant lens combines precise coverage with durability
- Choice of Auto-ON or Manual-ON operation, selectable for each relay
- Selectable walk-through mode turns lights off three minutes after the room is initially occupied if no motion is detected after the first 30 seconds
- Test mode allows quick and easy adjustments
- Selectable audible and/or visual alerts for impending shutoff
- In automatic mode, sensor returns automatically to Auto-ON after lights are turned off manually; ideal for presentations
- LED indicates occupancy detection
- Optional light level sensing with simple setup
- Override mode allows sensor to operate as a service switch in the unlikely event of a failure
- Sensor coverage tested to NEMA Guide Publication WD 7-2000
- Qualifies for ARRA-funded public works projects



Specifications

- PW-200: 120/230/277 VAC; 50/60 Hz
@ 120 VAC, 0-800 W ballast or tungsten, 1/6 hp
@ 230/277 VAC, 0-1200 W ballast
- PW-200-347: 347 VAC; 50/60 Hz; 0-1500 W ballast
- Time delays: Auto set, fixed (5, 10, 15, 20, 25 or 30 minutes), walk-through, test-mode
- Coverage: Major motion 35' x 30'
Minor motion 20' x 15'
- Sensitivity adjustment: PIR (high/low)
- Dimensions: 2.73" x 1.76" x 1.83"
(69.3mm x 44.7mm x 46.5mm) L x W x D
- UL and cUL listed
- Five year warranty

Controls & Settings

Product Controls

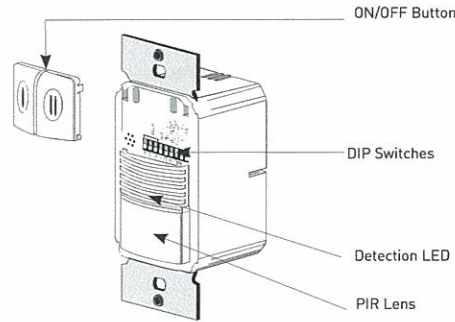

DIP Switch Settings

Time Delay	1	2	3
Auto/Test	↓	↓	↓
5 minutes	↓	↓	↑
10 minutes	↓	↓	↑
15 minutes	↓	↓	↑
20 minutes	↑	↓	↓
25 minutes	↑	↓	↓
30 minutes	↑	↑	↓
override	↑	↑	↓

Walk-Through	4
Disabled	↓
Enabled	↑

Time Delay	1	2	3	4
ON	↓	↓	↓	↓
Walk-Through	↓	↓	↓	↓
Visible Alerts	↓	↓	↓	↓
Audible Alerts	↓	↓	↓	↓
Relay 1 Mode	↓	↓	↓	↓
Relay 2 Mode	↓	↓	↓	↓

Audible Alert	7
Disabled	↓
Enabled	↑

PIR Sensitivity	5
High	↓
Low, 50%	↑

Visible Alert	6
Disabled	↓
Enabled	↑

Relay 1 Mode	8
Auto On	↓
Manual On	↑

Relay 2 Mode	9
Auto On	↓
Manual On	↑

↑ = ON ↓ = OFF ← = Factory Setting

⊗ Bypass occupancy & light level functions. Loads are manually controlled with PW-200 buttons.

Coverage & Wiring

Coverage Pattern

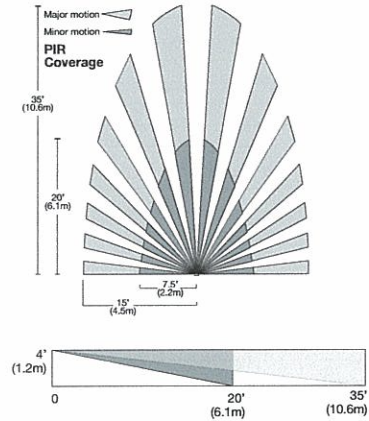

For best performance, WattStopper recommends using this sensor in spaces no larger than 15' x 12'.

Wiring Diagrams

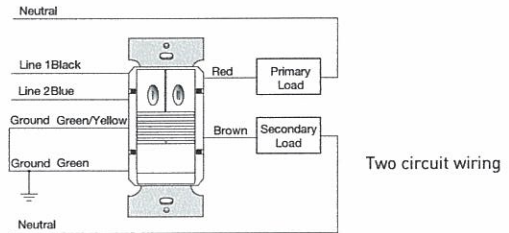
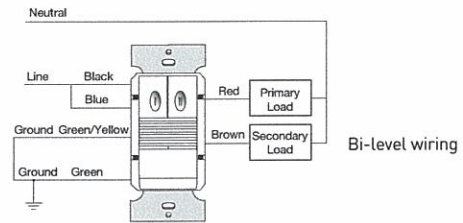

Ordering Information

Catalog No.	Color	Voltage	Load Rating
<input type="checkbox"/> PW-200-W	White	120/230/277 VAC; 50/60 Hz	@ 120 VAC, 0-800 W ballast or tungsten, 1/6 hp @ 230/277 VAC, 0-1200 W ballast
<input type="checkbox"/> PW-200-W-U			
<input type="checkbox"/> PW-200-W-FTA			
<input type="checkbox"/> PW-200-LA	Lt. Almond	347 VAC; 50/60 Hz	0-1500 W ballast
<input type="checkbox"/> PW-200-I	Ivory		
<input type="checkbox"/> PW-200-I-U			
<input type="checkbox"/> PW-200-I-FTA			
<input type="checkbox"/> PW-200-G	Grey		
<input type="checkbox"/> PW-200-B	Black		
<input type="checkbox"/> PW-200-347-W	White	347 VAC; 50/60 Hz	0-1500 W ballast
<input type="checkbox"/> PW-200-347-LA	Lt. Almond		
<input type="checkbox"/> PW-200-347-I	Ivory		
<input type="checkbox"/> PW-200-347-G	Grey		
<input type="checkbox"/> PW-200-347-B	Black		

One ASP-211 single-gang cover plate included. Order ASP-422 for blank 2-gang cover plate, ASP-432 for 2-gang cover plate with switch option [specify color].



TS-400 Digital Time Switch



PROJECT	3rd Floor Remodel
LOCATION/TYPE	Former Administration Building

Product Overview

Description

The IntelliSwitch TS-400 series digital time switches automatically turn lights off after a preset time. The simple pushbutton operation provides users with convenient time out lighting control without the nuisance of twist timers.

Operation

The TS replaces an existing wall switch. The TS-400 operates between 100 and 300 volts. Pressing the TS's on/off button turns lights on. The lights will remain on for the duration of the time-out setting which is adjustable from 5 minutes to 12 hours. Lights can be turned off before the time-out setting expires by pressing the on/off button. Also, the unit can be reset at any time by holding down the on/off button for 2 seconds. This will bring the timer back to its original time out setting and restart the countdown.

Time Scroll Overrides

The time scroll option allows users to temporarily override the time out setting without adjusting the settings. Time scroll is selected with the calibration button. With time scroll programmed to "UP", lights can be held on longer than the time out period. With time scroll programmed to down "DN", lights can be turned off sooner than the time out period. Pressing the on/off switch for more than 4 seconds causes the timer to scroll in the set direction throughout the possible time out settings.

Applications

The TS is an ideal lighting control choice in equipment rooms, storage areas, and closets.

Features

- Time-out settings range from 5 minutes to 12 hours for flexibility in fitting many applications
- Optional flash and beep warnings allow time to reset the switch if someone is present
- Time scroll option provides temporary override of the preset time out period
- Simple reset feature for returning the switch to its original preset time-out setting
- Electroluminescent back-lit LCD shows timer countdown
- Terminal style wiring simplifies installation
- Zero crossing reduces stress on the relay and increases product longevity
- Pushbutton programming gives the TS an easy set up process
- Setting the time-out for 2 hours and time scroll to down allows Title 24 compliance for using override switches

Specifications

- TS-400: Universal 120/230/277 VAC; 50/60 Hz
- Time-out adjustments range from 5 minutes to 12 hours (5 minute increments to 1 hour, then 15 minute increments to 12 hours)
- Optional visual warning: flashes lights at 5 minutes and 1 minute prior to time-out
- Optional audible warning: beeps every 5 seconds at 1 minute prior to time-out
- No minimum load requirement
- Compatible with all electronic ballasts and motor loads
- Dimensions: 2.66" x 1.79" x 1.76" (67.5mm x 45.5mm x 44.7mm)
- UL and CUL listed; Five year warranty

Controls & Installation

Product Controls

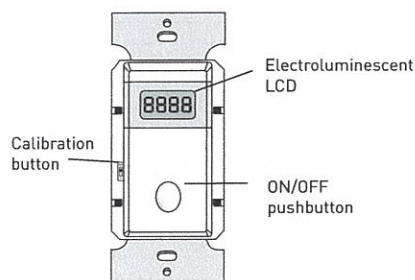

Installation

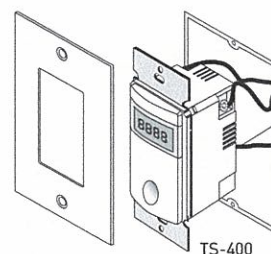

Wiring

TS-400 Single Level Lighting

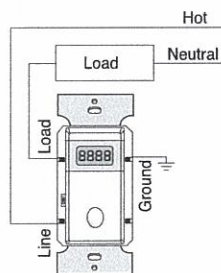

TS-400 3-Way Lighting

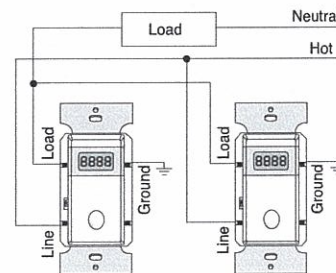

Ordering Information

Catalog No.	Color	Voltage	Load Requirement
<input type="checkbox"/> TS-400-W	White	120 VAC; 50/60 Hz or 230/277 VAC; 50/60 Hz	0-800 Watt ballast or 0-1200 Watt ballast
<input type="checkbox"/> TS-400-I	Ivory		
<input type="checkbox"/> TS-400-A	Lt. Almond		
<input type="checkbox"/> TS-400-B	Black		
<input type="checkbox"/> TS-400-G	Grey		

One ASP-211 single-gang cover plate included. Order ASP-422 for blank 2-gang cover plate, ASP-432 for 2-gang cover plate with switch option (specify color).





WPIR Passive Infrared Ceiling Sensor

PIR sensor turns lights on and off based on occupancy

User-adjustable time delay of 30 seconds to 30 minutes

Automatic or manual-on operation when used with a BZ-150 Power Pack

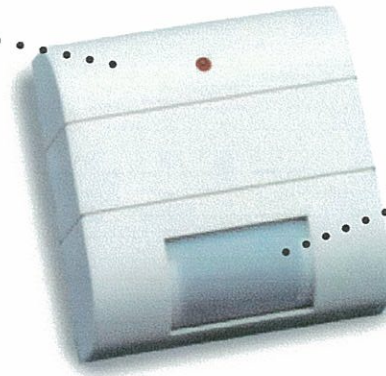

ASIC technology reduces components and provides greater reliability

30-segment, multi-element Fresnel lens

PROJECT	3rd Floor Remodel
LOCATION/TYPE	Former Administration Building

Product Overview

Description

WattStopper's WPIR Sensor is a versatile ceiling-mount sensor that utilizes the latest passive infrared (PIR) technology to turn lights on and off based on occupancy. The WPIR controls lighting in a wide variety of applications, but is especially adept at controlling small spaces with well-defined coverage.

Operation

The WPIR Ceiling Sensor utilizes the latest PIR technology to detect the difference between the infrared energy from a person in motion and the background space within the controlled area. When occupancy is detected, this 24 VDC sensor turns lighting or HVAC systems on through a WattStopper power pack controlled through low voltage wiring. When occupants leave the area, lighting is switched off after the user-adjustable time delay has elapsed.

Fresnel Lens and Coverage

The WPIR is equipped with a multi-element Fresnel lens that allows the sensor to efficiently collect infrared energy and provides optical gain over a defined field of view. The profile of each groove facet is determined by computer simulation to produce the sharpest images possible from a distant object. The use of a 30-segment lens allows overlapping coverage within the defined field of view. The coverage is partially determined by the view available to the sensor. Mounted to a wall, the WPIR will produce a completely different viewing pattern. Zone 4 and 5 (see diagram on back) are then capable of sensing up to 45 feet.

Applications

The WPIR can effectively cover small offices, utility areas or computer rooms. Additional applications include racquetball courts, garage areas, library aiseways and storage rooms.

Features

- ASIC technology enhances reliability and provides immunity to RFI and EMI
- Uses the latest PIR technology to reliably control lighting in a variety of applications
- User-adjustable time delay of 30 seconds to 30 minutes
- Incorporated daylight filter prevents short-wavelength infrared waves, such as those emitted by the sun, from affecting WPIR
- Multi-element Fresnel lens allows the sensor to efficiently collect infrared energy and provide optical gain over a defined field of view
- Alternate viewing patterns depending on mounting choice
- Optional on override through logic key/on bypass
- LED indicates occupancy detection
- Qualifies for ARRA-funded public works projects



Specifications

- Dual-element, temperature compensated pyroelectric sensor
- Adjustable time delay: 30 seconds to 30 minutes
- Poly IR4 lens, optical filter material
- Control output: 100mA maximum
- Max. units per power pack: B = eight; BZ = ten
- Dimensions: 2.5" x 2.5" x 1.14" (64mm x 64mm x 29mm) W x L x D
- UL and cUL listed
- Five year warranty

Wiring & Controls

Product Controls

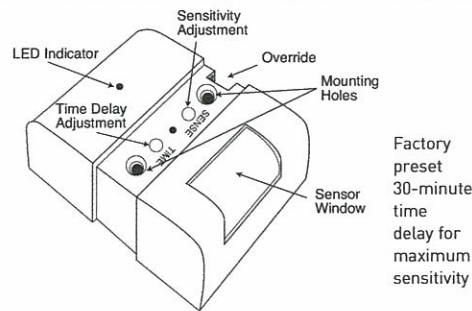

Wiring Diagram

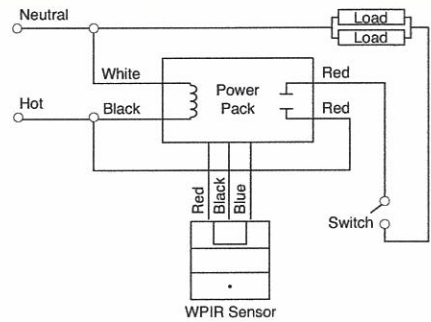

Coverage & Placement

Coverage Pattern

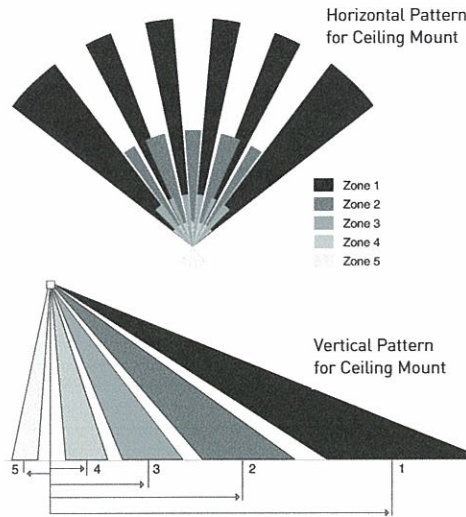

Typical Office Placement

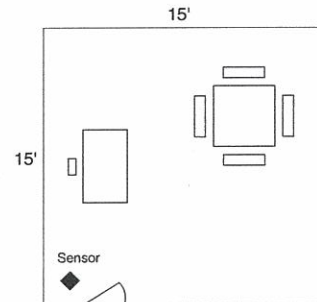

For an enclosed office, the WPIR should be placed in the corner of the room so that it will detect occupants as they enter the room. For the aisleway between bookstacks, the WPIR should be placed at the end of each bookstack to detect occupancy upon entrance to the aisle way from either direction. For longer bookstacks, two or more WPIRs can be used.

Aisleway Library Bookstack Placement

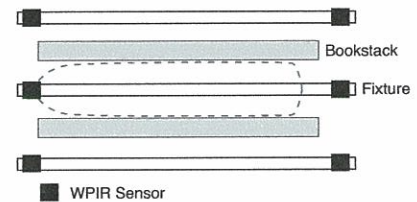

Ceiling Height	Detection Zones				
	Zone 5	Zone 4	Zone 3	Zone 2	Zone 1
8'	-1	1	4	8	15
10'	-1.5	1.5	5	10	19
12'	-2	2	6	12	23
15'	-2.5	2.5	8	15	29
20'	-3	3	10	18	36
25'	-4	4	12	23	45
*8'	50	40	25	15	5

* Wall mounted Horizontally

Ordering Information

Catalog No.	Voltage	Current	Coverage
□ WPIR	24 VDC	14 mA	300 ft ² [27.9 m ²]

All units are white and use WattStopper power packs.



DT-300 Series Dual Technology Ceiling Sensors

Architecturally appealing
low-profile appearance

Auto set automatically
selects optimal settings
for each space

Walk-through mode
increases savings potential

Ultrasonic diffusers give more
comprehensive coverage

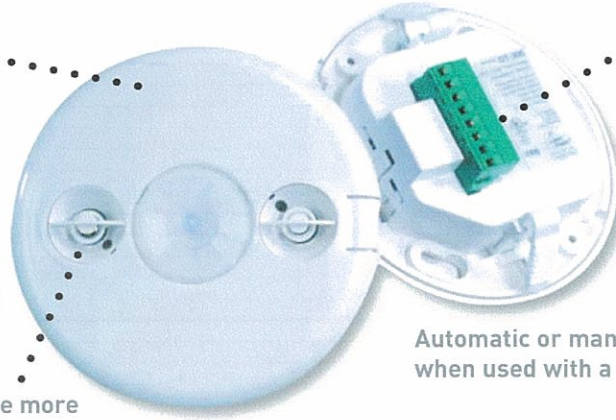

Plug terminal wiring for
quick and easy installation

Accepts low-voltage
switch input for
manual-on operation

Automatic or manual-on operation
when used with a BZ-150 Power Pack

PROJECT	3rd Floor Remodel
LOCATION/TYPE	Former Administration Building

Product Overview

Description

The DT-300 Series Dual Technology Ceiling Sensors combine the benefits of passive infrared (PIR) and ultrasonic technologies to detect occupancy. Sensors have a flat, unobtrusive appearance and provide 360 degrees of coverage.

Operation

Low voltage DT-300 Series sensors utilize a WattStopper power pack to turn lights on when both PIR and ultrasonic technologies detect occupancy. They can also work with a low voltage switch for manual-on operation. PIR technology senses motion via a change in infrared energy within the controlled area, whereas ultrasonic uses 40KHz high frequency ultrasound. Once lights are on, detection by either technology holds them on. When no occupancy is detected for the length of the time delay, lights turns off. DT-300 Series Sensors can also be set to trigger lights on when either technology or both detect occupancy, or to require both technologies to hold lighting on.

Auto Set

The DT-300 requires no adjustment at installation. Auto set continuously monitors the controlled space to identify usage patterns. Based on these patterns, the unit automatically adjusts time delay and sensitivity settings for optimal performance and energy efficiency. Sensors assigns short delays (as low as five minutes) for times when the space is usually vacant, and longer delays (up to 30 minutes) for busier times.

Application

DT-300 Series Dual Technology Sensors have the flexibility to work in a variety of applications, where one technology alone could cause false triggers. Ideal applications include classrooms, open office spaces, large offices and computer rooms. The DT-300 Series mounting system makes them easy to install in ceiling tiles or to junction boxes, providing the flexibility to be used in a wide range of spaces.

Features

- Advanced control logic based on RISC microcontroller provides:
 - Detection Signature Processing eliminates false triggers and provides immunity to RFI and EMI
 - Walk-through mode turns lights off three minutes after the area is initially occupied – ideal for brief visits such as mail delivery
 - Available with built-in light level sensor featuring simple, one-step setup
- Sensors work with low-voltage momentary switches to provide manual control
- Patented ultrasonic diffusion technology spreads coverage to a wider area
- LEDs indicate occupancy detection
- Uses plug terminal wiring system for quick and easy installation
- Eight occupancy logic options provide the ability to customize control to meet application needs
- Available with isolated relay for integration with BAS or HVAC
- Qualifies for ARRA-funded public works projects



Specifications

- 24 VDC/VAC
- Ultrasonic frequency: 40kHz
- Time delays: Auto set, fixed (5, 10, 15, 20, or 30 minutes), Walk-through/Test Modes
- Sensitivity adjustment: Auto set; reduced sensitivity (PIR); variable with trim pot (ultrasonic)
- Built-in light level sensor: 10 to 300 footcandles (107.6 to 3,229.2 lux)
- Low-voltage, momentary switch input for manual on or off operation

- DT-300 contains an isolated relay with N/O and N/C outputs; rated for 1 Amp @ 30 VDC/VAC
- Multi-level Fresnel lens provides 360° coverage
- Mounting options: ceiling tile; 4" octagonal J-box, 1.5" deep
- Max DT-300s per power pack: B=2, BZ=3
Max DT-305s per power pack: B=3, BZ=4
- Dimensions: 4.50" diameter x 1.02" deep (114.3mm x 25.9mm)
- UL and cUL listed
- Five year warranty

Wiring & Mounting

Wiring Diagram

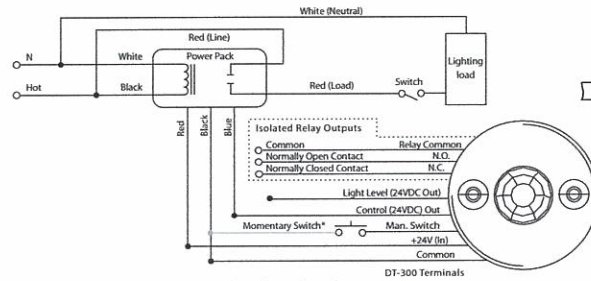

*Momentary switch connection is optional.
Connect only when momentary switch is installed.

Ceiling Mounting

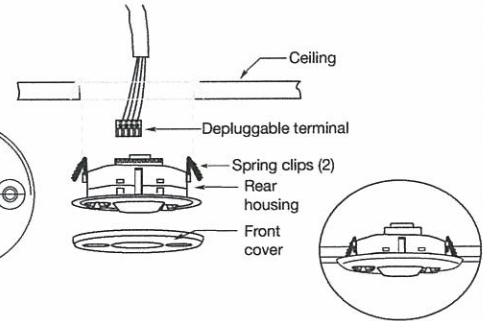

Controls & Settings

Product Controls

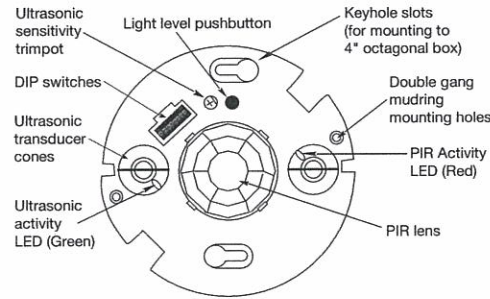

DIP Switch Settings

◀ = Factory Setting
● = ON
- = OFF

Occupancy Logic	Switch#		
	1	2	3
Standard	-	-	-
Option 1	●	-	-
Option 2	-	●	-
Option 3	●	●	-
Option 4	-	-	●
Option 5	-	-	●
Option 6	●	-	●
Option 7	●	●	●

Time Delay	4	5	6
5 sec/SmartSet	-	-	-
5 minutes	-	-	●
10 min.	-	-	●
10 minutes	-	●	●
15 min.	●	-	-
15 minutes	●	-	●
20 minutes	●	-	●
30 min.	●	●	●

Occupancy Logic	Initial Occupancy	Maintain Occupancy	Re-trigger (seconds duration)
Standard	Both	Either	Either(5)
Option 1	Either	Either	Either(5)
Option 2	PIR	Either	Either(5)
Option 3	Both	Both	Both(5)
Option 4	PIR	PIR	PIR(5)
Option 5	Ultra	Ultra	Ultra(5)
Option 6	Man.	Either	Either(30)
Option 7	Man.	Both	Both(30)

LEDs	7
Disabled	-
Enabled	●

PIR Sensitivity	8
Minimum	-
Max./SmartSet	●

⚙️ = walk-through mode

Coverage

Coverage Pattern

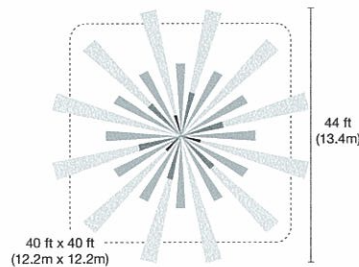

Coverage shown is maximum and represents half-step walking motion. Under ideal conditions, coverage for half-step walking motion can reach up to 1000 ft².

The technology control (occupancy logic) options are adjustable by user. The standard setting recommended for most applications requires both technologies to trigger on, either to hold on.

Ordering Information

Catalog No.	Voltage	Current	Coverage	Features
<input type="checkbox"/> DT-300	24 VDC/VAC	43 mA	up to 1000 ft ² [92.9 m ²]	Isolated relay, light level
<input type="checkbox"/> DT-300-U				
<input type="checkbox"/> DT-305	24 VDC/VAC	35 mA	up to 1000 ft ² [92.9 m ²]	
<input type="checkbox"/> DT-305-U				

Sensors are white and use WattStopper power packs. Current consumption can be slightly higher when only one sensor per power pack is used.



WT Ultrasonic Ceiling Sensors

Ultrasonic technology with 32 KHz frequency

Automatic or manual-on operation when used with a BZ-150 Power Pack

Advanced Signal Processing circuitry automatically adjusts detection threshold



User-adjustable DIP switch time delay and sensitivity settings

Hallway and 600, 1100 and 2200 square foot coverages available

Omni-directional, Doppler technology

Isolated relay allows sensor to interface with building control systems

PROJECT

3rd Floor Remodel

LOCATION/TYPE

Former Administration Building

Product Overview

Description

Watt Stopper/Legrand's WT Ultrasonic Ceiling Sensors utilize 32 KHz frequency ultrasonic technology to detect occupancy. The sensors are available in several models to control lighting in a wide variety of applications.

Operation

WT Sensors are 24 VDC and utilize advanced, omni-directional, Doppler technology. When movement is detected in a controlled area, it switches lighting on through a Watt Stopper/Legrand power or auxiliary pack. The sensor controls the power pack through low voltage wiring. Once the area is vacated and the time delay has elapsed, lighting systems automatically switch off.

Advanced Signal Processing (ASP)

WT Sensors use Watt Stopper/Legrand's ASP circuitry, which filters out moving air noise by checking for small cyclical changes found in turbulent air. This helps to eliminate false on problems found in sensors without ASP.

Applications

WT sensors offer excellent control of lighting for many areas of a building. The sensors are designed to effectively control offices, restrooms, storage areas and open office areas, and can control large partitioned office spaces when configured in zone patterns. The WT can be used with BD Din Rail Mounted Power Packs and low-voltage momentary wall switches to achieve manual-on/auto-off control. The WT sensors' superior performance and ease of installation will provide fast paybacks and many years of energy savings.

Features

- ASP circuitry helps to eliminate false on
- Advanced, omni-directional, Doppler technology for reliable occupancy detection
- Angled transmitter and receiver pairs help optimize sensitivity while eliminating unwanted detection from ceiling air movement
- Coverage ranges from 600 to 2200 square feet, and 90 linear feet for hallways
- Isolated relay can interface with HVAC, EMS or an additional lighting load
- DIP switch-adjustable time delay and sensitivity
- LED indicates occupancy detection



Specifications

- Solid state, crystal-controlled (32.768 kHz \pm 0.002%)
- Omni-directional transmission (360° coverage)
- Temperature and humidity resistant 32 kHz receivers
- Digital DIP switch time delay: 15 seconds to 30 minutes
- Isolated relay with N/O and N/C outputs; rated for 1 Amp @ 30 VDC/VAC
- Mounts to ceiling tile or Wiremold V5738-WH box
- Max. WT-605s per power pack: B=4, BZ=5
- Max. WT-600s per power pack: B= 3, BZ=4
- Max. WT-1105s, WT-2205s, WT-2255s: B=3, BZ=5
- Max. WT-1100s, WT-2200s, WT-2250s: B=2, BZ=3
- Dimensions: 4.8" x 1.5" (122mm x 38mm) diameter x depth
- UL and CUL listed; five-year warranty

Wiring, Installation & Placement

Wiring & Controls

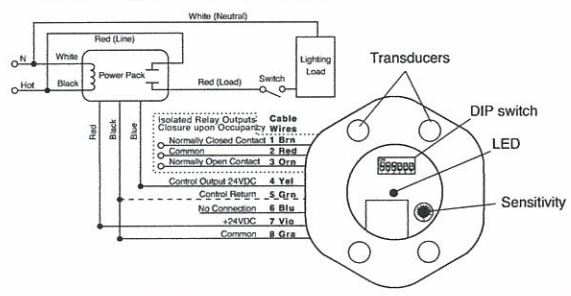

Installation

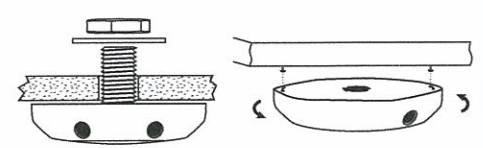

Mount the sensors to a vibration-free surface with the receivers facing the area of coverage.

Note: Place 4' away from supply ducts, 6' from horizontal discharge ducts and 6" from power packs.

Enclosed Office Placement

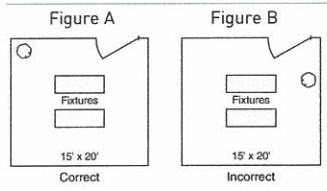

For enclosed spaces, place sensors as in Figure A. Sensors placed as in Figure B may see out the door and cause false triggers.

Open Office Placement

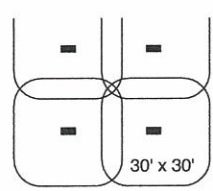

A typical layout for an open office space would be to place W-2000A sensors so they control zones that overlap. For partitioned spaces, a typical zone is about 25' x 25' with an overlap on the coverages that senses motion up to 30' x 30'.

Coverage & Settings

Coverage

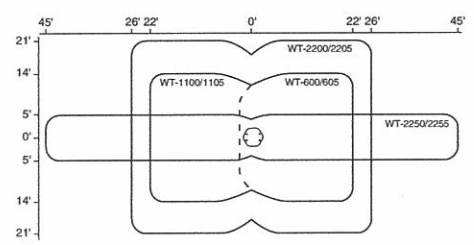

Coverages shown represent half-step walking motion. Actual coverages can vary for each application depending on the shape and use of space and the obstacles present. Coverage may be reduced if product is mounted greater than 12 feet high.

DIP Switch Settings

◀ = factory preset
● = ON ◯ = OFF

Time Delay	DIP Switch #					
	1	2	3	4	5	6
15 seconds	●	○	○	○	○	○
2 minutes	○	○	○	○	○	○
4 minutes	○	○	○	○	○	○
6 minutes	○	○	○	○	○	○
8 minutes	○	○	○	○	○	○
10 minutes	○	○	○	○	○	○
12 minutes	○	○	○	○	○	○
14 minutes	○	○	○	○	○	○
16 minutes	○	○	○	○	○	○
18 minutes	○	○	○	○	○	○
20 minutes	○	○	○	○	○	○
22 minutes	○	○	○	○	○	○
24 minutes	○	○	○	○	○	○
26 minutes	○	○	○	○	○	○
28 minutes	○	○	○	○	○	○
30 minutes	○	○	○	○	○	○
Output Disable	○	○	○	○	○	○
Override	○	○	○	○	○	○

Ordering Information

Catalog No.	Voltage	Current	Coverage	Feature
<input type="checkbox"/> WT-605	24 VDC	27 mA	360° one-sided, 600 ft ² [55.7 m ²]	
<input type="checkbox"/> WT-600	24 VDC	37 mA	360° one-sided, 600 ft ² [55.7 m ²]	Isolated relay
<input type="checkbox"/> WT-1105	24 VDC	30 mA	360° two-sided, 1100 ft ² [102.2 m ²]	
<input type="checkbox"/> WT-1100	24 VDC	40 mA	360° two-sided, 1100 ft ² [102.2 m ²]	Isolated relay
<input type="checkbox"/> WT-2205	24 VDC	30 mA	360° two-sided, 2200 ft ² [204.4 m ²]	
<input type="checkbox"/> WT-2200	24 VDC	40 mA	360° two-sided, 2200 ft ² [204.4 m ²]	Isolated relay
<input type="checkbox"/> WT-2255	24 VDC	30 mA	360° two-sided, 90 linear ft [27.4 m]	
<input type="checkbox"/> WT-2250	24 VDC	40 mA	360° two-sided, 90 linear ft [27.4 m]	Isolated relay

All units are white and use Watt Stopper power packs. Current consumption can be slightly higher when only one sensor per power pack is used.



BZ-50 Universal Voltage Power Pack



High-efficiency switching power supply

Overcurrent protection (low-voltage)

Plenum rated

120/230/277VAC,
50/60Hz

Zero crossing for reliability and increased product life

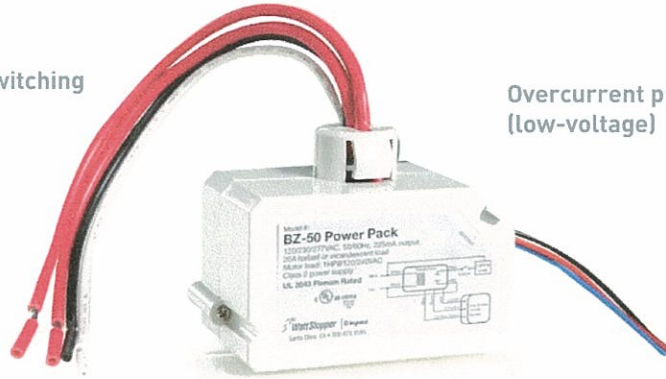

PROJECT	3rd Floor Remodel
LOCATION/TYPE	Former administration Building

Product Overview

Description

The BZ-50 Universal Voltage Power Pack provides 24 VDC operating voltage to Watt Stopper's low-voltage occupancy sensors. This device is constructed with environmentally friendly materials and is RoHS-compliant.

Operation

The BZ-50 consists of a high-efficiency switching power supply and a high-current relay. It has an input of 120-277 VAC, 50/60Hz, and an output of 24VDC, 225mA. It turns the connected load on and off automatically based on occupancy sensor input.

Plenum Rated

The BZ-50 Power Pack is comprised of Teflon-coated low-voltage leads and an ABS, UL 2043 and 94V-0 plastic resin enclosure that is plenum-rated. As a result, the BZ-50 does not require installation into the junction box, but can be cost-effectively installed directly into the plenum.

Applications

The BZ-50 Power Pack is designed to be flexible enough to control almost any lighting or HVAC load, such as lighting circuits, self-contained air conditioners, pumps, fans, motors, VAV systems, motorized damper controls and setback thermostats. The BZ-50 is well-suited for any application which requires high-voltage switching through low-voltage controls. By linking power packs and sensors, an almost unlimited number of configurations can be obtained.

Features

- Self-contained power supply relay system
- Efficient switching power supply providing optimized current output based on number of sensors
- LED indicates status of relay or if there is a low-voltage overcurrent
- RoHS-compliant
- Zero crossing circuitry for reliability and increased product life
- UL 2043 plenum rated for cost-effective installation
- 1/2" snap-in nipple attaches to standard electrical enclosures through 1/2" knockouts
- 14 AWG wires on the relay for 20A operation



www.wattstopper.com
800.879.8585



Specifications

- 120/230/277VAC, 50/60Hz voltage input
- Secondary voltage of 24 VDC
- Secondary output of 225 mA (with relay connected)
- Low-voltage leads are rated for 300 volts
- UL-rated 94 V-0 grey plastic enclosure
- Dimensions: 1.6" x 2.75" x 1.6" (40.6mm x 69.9mm x 40.6mm) H x W x D with a 1/2" (12.7mm) snap-in nipple
- UL and CUL listed; five-year warranty

System Layout & Wiring

Installation Diagram

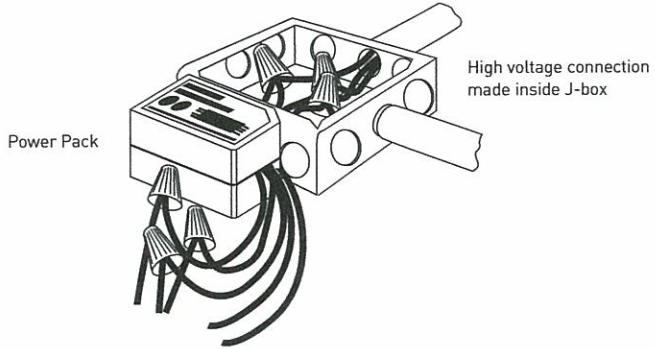

Wiring with Occupancy Sensor

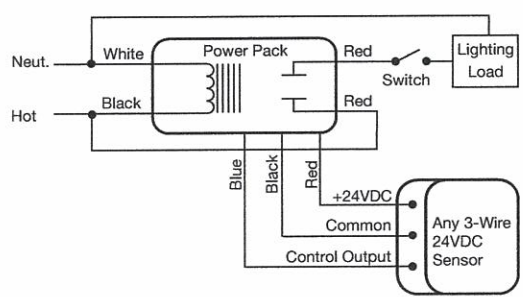

Auxiliary Relay Pack with Sensor

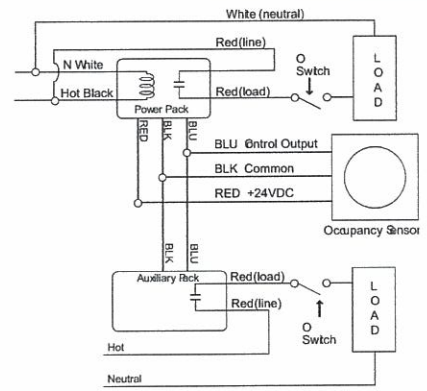

Ordering Information

Installation Notes

Catalog No.	Input Voltage	Load Ratings			Output
		Ballast(A)	Incan(A)	Motor(HP)	
□ BZ-50	120/230/277VAC; 50/60Hz	20	20	1*	24 VDC; 225 mA**

*1 Hp rated at 120/250 VAC. **Output is 225 mA with relay connected.

1) All Watt Stopper power packs should be installed in accordance with state, local, and national electrical codes and requirements.
 2) Power packs are designed to attach to existing or new electrical enclosures with .5" 125.40mmJ knockout [check electrical codes in your area].
 3) Most applications require UL-listed, 18-22 AWG, 3-conductor, Class 2 cables for low-voltage wiring. For plenum return ceilings use UL-listed plenum-approved cables.