

**HIDALGO COUNTY PRECINCT #3  
BORDER COLONIA ACCESS PROGRAM  
ROUND III**

**TECHNICAL SPECIFICATIONS FOR TURN KEY**

**RANDOLPH BARNETT SUBDIVISION NO.1**

**Elizabeth Street**

**CSJ#3C1080600**

**JAVIER HINOJOSA ENGINEERING**

**416 E. DOVE AVENUE**

**McALLEN, TEXAS 78504**

**(956) 668-1588**

**FAX: (956) 994-8102**

**E-mail: [javhin@rgv.rr.com](mailto:javhin@rgv.rr.com)**

**TBPE FIRM NO. F-1295**

**TABLE OF CONTENTS**  
**CAP-00-000-000-00-YSI**  
**RANDOLPH BARNETT SUBDIVISION NO. 1**

- 1) Advertisement and Invitation for Bids
- 2) Hidalgo County Legal Notice
- 3) Bidder Acknowledgement
- 4) Information for Bidders
- 5) Bid Form
- 6) Bid Bond
- 7) Draft Contract
- 8) Non Collusion
- 9) Payment Bond
- 10) Performance Bond
  
- 11) **Exhibit C**
  - a. Insurance
  
- 12) General Conditions of the Agreement
- 13) Title 29 Labor
- 14) Standard General Condition of Construction Contract
- 15) Supplemental General Condition
  
- 16) **Exhibit A** General Notes & Standard Specifications
  - a. Technical Specifications
  - b. Government Specifications & Special Provisions
  
- 17) **Exhibit B**
  - a. Debarment
  - b. W-9
  - c. Bidder/Vendor Application
  - d. Conflict of Interest Memo
  - e. Conflict of Interest Form
  - f. Sales Tax and Local Sales Tax Certificate
  
- 18) **Exhibit D** Border Wage Rates
  - a. Government code Ch 2258
  - b. Prevailing Wage Rate
  - c. Davis Bacon
  
- 19) **Exhibit E**
  - a. Checklist
  - b. Change Order
  - c. Payment of Application
  - d. Estimate Quantity Update
  - e. Schedule of Values
  - f. Contract Time Statement
  - g. Colonia Testing Requirement
  - h. List of Suppliers

- i. Partial Release of Lien
- j. Contractor's Affidavit of Payment of Debts and Claims
- k. Prevailing Wage Rates Certificate Statement
- l. Certificate of Construction Completion
- m. Contractor's Affidavit of Release of Liens
- n. Payment Schedule
- o. Quantity Work Sheet

20) Construction Identification Sign

# REQUEST FOR BIDS

## (Colonia Access Program Project)

TO SUPPLY HIDALGO COUNTY PRECINCT NO. 3 with sealed bids on:  
CAP-00-000-00-00-YSI "ROAD & DRAINAGE CONSTRUCTION FOR RANDOLPH BARNETT SUBDIVISION NO. 1"

A BIDDER'S BOND from a reliable surety company licensed to operate in the State of Texas or certified Cashier's Check, payable without recourse to the County of Hidalgo, for the amount of not less than 5% of the total bid shall accompany the bid as guaranty that, if awarded the contract, the bidder will enter into a contract with the County of Hidalgo. Payment and Performance Bonds shall be executed except in the event into a single payment contract with the County of Hidalgo in lieu of a Performance Bond. In the event the total amount bid is \$25,000 or less, the successful contract has the option to enter into a single payment contract with the County of Hidalgo in lieu of a Payment and Performance Bond.

**Bid Packets** may be obtained from the office of JAVIER HINOJOSA ENGINEERING, 416 E. DOVE AVENUE McAllen, Texas 78504, Phone No (956) 668-1588 for the amount of \$\_\_\_\_\_. General and/or Prime Contractors submitting bids and/or proposals to the County of Hidalgo shall be non-refundable.

PRE-BID CONFERENCE is scheduled for \_\_\_\_\_, \_\_\_\_\_,  at 2:00 P.M. at HIDALGO COUNTY NEW ADMINISTRATION BUILDING - PURCHASING DEPARTMENT 2812 S Business Hwy 281, EDINBURG, TEXAS 78539.

UPON SUBMITTING SEALED BID, bidders are required to properly identify (handwritten, typed or printed) sealed envelope and/or packet as follows: Bidder's name and address on the upper left hand corner of the sealed envelope and/or package and Bid No.: CAP-00-000-00-00-YSI "ROAD & DRAINAGE CONSTRUCTION FOR RANDOLPH BARNETT SUBDIVISION NO. 1" on the lower left hand corner of sealed envelope/and or packet. **OVERNIGHT MAIL MUST ALSO BE PROPERLY LABELED ON THE OUTSIDE OF EXPRESS ENVELOPE OR PACKAGE.**

The sealed bid must contain one (1) original and three (3) copies of bid and must be clearly identified and addressed for delivery to:

Martha L. Salazar, CPPB, Hidalgo County Purchasing Agent  
Hidalgo County Purchasing Department

US Postal Mail/Courier Address  
Hidalgo County New Administration Building  
2812 S. Business Hwy 281  
Edinburg, Texas 78539

Physical Location:  
Hidalgo County New Administration Building  
2802 S. Business Hwy. 281  
(Southeast of Canton Rd & Business 281)  
Edinburg, Texas 78539

Sealed bids will be accepted until **9:30 a.m. on Wednesday**, \_\_\_\_\_,  at which time they will be opened in the Hidalgo County Purchasing Department Conference Room at **Physical Location: 2802 S. Business Hwy 281, Hidalgo County New Administration Building, Edinburg, Texas 78539**. NO FACSIMILES OR LATE ARRIVALS WILL BE ACCEPTED. ANY BID RECEIVED AFTER THAT TIME WILL NOT BE OPENED AND WILL BE RETURNED

The project is to be funded with Border Colonia Access Program funds through Proposition II Funding from the Texas Department of Transportation (Tx.D.O.T.) and Urban County Program CDBG funds.

Attention is called to the fact that not less than, the federally determined prevailing (**Davis-Bacon and Related Acts**) wage rate, as issued and contained in the contract documents, must be paid on this project. In addition, the successful bidder must ensure that employees and applicants for employment are not discriminated against because of race, color, religion, sex, age, disability or national origin.

**BIDS MAY BE HELD** by the County of Hidalgo for a period not to exceed ninety (90) days from the date of the opening of bids for the purpose of reviewing the bids and investigating the qualifications of bidders, prior to awarding of the contract.

**THE COUNTY** reserves the right to refuse and reject any/all bids and to waive any/all formalities or technicalities, or to accept the bids considered the best and most advantageous to the County.

**BY ORDER OF THE COMMISSIONERS COURT OF HIDALGO COUNTY, TEXAS** on this the \_\_\_\_ day of \_\_\_\_\_, .

MARTHA L. SALAZAR, CPPB  
HIDALGO COUNTY PURCHASING AGENT

**REPORT ROAD HAZARDS @ 1-866-HCR-SAFE OR 1-866-427-7233**

LEGAL NOTICE

BID NO:CAP-00-000-00-00-YSI

1. Sealed bids will be received for **“HIDALGO COUNTY PRECINCT NO. 3- ROAD AND DRAINAGE CONSTRUCTION FOR RANDOLPH BARNETT SUBDIVISION NO. 1”** in accordance with the specifications attached as Exhibit "A" hereto. Bids should address all specifications set forth. Bidders may suggest substitutions of features which they feel would be in the best interest of Hidalgo County ("County"). Strong rationale must be presented for any deviation from the specifications. Hidalgo County reserves the right to reject the deviation and its effect on the overall bid.
2. One (1) original and Three (3) copies of all bids are required with the bidders name and return address clearly typed/printed on upper left hand corner and the proper notation clearly typed/printed on the lower left hand corner of the envelope and/or package: **"BID-CAP-00-000-00-00-YSI HIDALGO COUNTY PRECINCT NO. 3- ROAD AND DRAINAGE CONSTRUCTION FOR RANDOLPH BARNETT SUBDIVISION NO. 1"** and in County's Purchasing Department, 100 E. Cano, 4<sup>th</sup> Floor, Administration Building, Edinburg, Texas, **on or before 9:30 a.m., WEDNESDAY, \_\_\_\_\_, \_\_\_\_\_, NO FACSIMILES OR LATE ARRIVALS WILL BE ACCEPTED. ANY RFB RECEIVED AFTER THAT TIME WILL NOT BE OPENED AND WILL BE RETURNED. OVERNIGHT MAIL MUST ALSO BE PROPERLY LABELED ON THE OUTSIDE OF EXPRESS ENVELOPE OR PACKAGE WITH REFERENCE TO "REQUEST FOR BIDS-CAP-00-000-00-00-YSI HIDALGO COUNTY PRECINCT NO. 3- ROAD AND DRAINAGE CONSTRUCTION FOR RANDOLPH BARNETT SUBDIVISION NO. 1"**. Hidalgo County reserves the right to refuse and reject any/all RFB and to waive any/all formalities or technicalities, or to accept the RFB considered the best and most advantageous to Hidalgo County. Hidalgo County reserves the right to refuse and reject any/all bids and to waive any/all formalities or technicalities, or to accept the bid considered the best and most advantageous to Hidalgo County
3. Hidalgo County reserves the right to: A. separate and accept, or eliminate any item(s) listed under this bid that it deems necessary to accommodate budgetary and/or operational requirements; B. reject any or all bids submitted and further reserves the right to design the evaluation criteria to be used in selecting the lowest and best bid for approval; and C. award the bid to one bidder or to multiple bidders if the County determines it is in its best interest to do so."
4. The Bidder shall not substitute items named in the bid without the express written consent of Hidalgo County. Failure of the delivered item(s) to perform as specified, or failure to meet the stated delivery schedule shall release Hidalgo County from all obligations to the contracting party with regard to the item(s) in question. In such event, County may elect to award the contract to the next-lowest responsible bidder, or to reject all bids and re-advertise.
5. For work to be performed at a County owned or operated location, each bidder shall, in its sole discretion, visit the job site before preparing the bid and thoroughly familiarize himself/herself with existing conditions. Bidder should take field dimensions and note all circumstances which affect the dollar amount of the bid.

6. Descriptive specifications are referenced in this document to indicate the general kind and quality of equipment desired by Hidalgo County. Due to various styles and models of equipment, bidders are required to include illustrations, specifications, explanation of warranties, and service data with their bid including catalogue numbers and any necessary references.
7. No bid may be withdrawn within thirty (30) days from the scheduled time to open bids.
8. Proposed prices are to remain firm for a minimum of ninety (90) days after bid opening.
9. Any interpretations, amendments, corrections or changes to this bid document must be in a written addendum and signed by the County Judge or his designee. Addenda will be mailed to all who are known to have received a copy of the Request for Bids. Bidders shall acknowledge receipt of all addenda as a part of their bid.
10. County reserves the right to accept or reject any or all bids.
11. Discrepancies between the indicated sum of any column of figures and the correct sum thereof will be resolved in favor of the correct sum. Discrepancies between words and figures will be resolved in favor of the words.
12. Costs are to be net F.O.B., County Prepaid.
13. Hidalgo County is exempt from Federal Excise Tax, State Tax and Local Tax. Do Not include tax in cost figure. If it is determined that tax was included in the cost figures it will not be included in the tabulation of any awards. Tax exemption certificates will be furnished upon request.
14. Funds for this procurement have been provided through the County budget for this fiscal year only. County, on an annual basis, has the right to reconsider a contract during the budget process for ensuing years if financial resources of County are insufficient to meet the liabilities of said contract. The award of a bid or contract hereunder will not be construed to create a debt of the County which is payable out of funds beyond the current fiscal year.
15. Upon award and prior to execution of a contract, Sole Proprietorships are required to submit a copy of their social security cards to the Hidalgo County Auditor's Office in order to establish an account with the County. All awarded vendors must submit a completed W-9 and a copy of their Federal ID Number Certificate.
16. DELIVERY INSTRUCTIONS:
  - . No deliveries accepted after 3:00 P.M., Monday-Friday.
  - . At least seventy two (72) hours prior notice of delivery must be given to Martha L. Salazar, Purchasing Agent before delivery will be accepted.
  - . If you need additional information call the office listed below:

Hidalgo County Purchasing Department  
Martha L. Salazar, Purchasing Agent  
(956) 318-2626

17. BILLING AND PAYMENT INSTRUCTIONS:

- . Invoices must include:
  - a) Name and address of successful bidder
  - b) Name and address of receiving department or official
  - c) Purchase Order Number (if any)
  - d) Notation - "HIDALGO COUNTY PRECINCT NO. 3- ROAD AND DRAINAGE CONSTRUCTION FOR RANDOLPH BARNETT SUBDIVISION NO. 1" Descriptive information as to the items or services delivered, including product code, item number, quantity, etc.
  
- . Discount payments will be considered when offered.
  
- . Contact person for Billing and Payment questions:

Hidalgo County Colonia Access Program  
302 E. State Avenue  
Pharr, Texas 78577  
ATTN.: Marcie Jackson, Administrative Assistant

18. Schedule of Events

**Bid Opening, 9:30 AM**

Award of Contract

Commence Work or Deliver Products

_____	,	<div style="border: 1px solid red; width: 50px; height: 40px;"></div>
_____	,	
_____	,	

19. Bid or Performance Bond and Debarment Certification; Payment Under Contract:

. If the contract proposed is for the construction of public works or is for a contract for goods & services exceeding \$100,000, all bidders shall furnish a good and sufficient bid bond in the amount of five percent of the total contract price. A bid bond must be executed with a surety company authorized to do business in Texas. All bidders are also required to furnish a certification or acknowledgment stating that the contractor or vendor is free from suspension or debarment pursuant to federal regulation 45CFR Part 76.

. Together with the signing of a contract or issuance of a purchase order following the acceptance of a bid, and prior to commencement of the actual work, the bidder shall furnish a performance bond to the County for the full amount of the contract, if that contract exceeds \$50,000.

. If the contract is for \$50,000 or less, no money will be paid to the contractor until completion and acceptance of the work or the fulfillment of the purchase obligation to the County, and, if applicable, the receipt by County of satisfactory evidence that all subcontractors and material men have been paid.

. If a contract is for the construction, alteration or repair of public buildings or public works, the contractor *shall* provide a payment bond for a contract in excess of Twenty Five Thousand Dollars (\$25,000.00), as required by Tex. Govt. Code Ch. 2253.

. For requirements contracts, bond requirements are determined by applying the proposed unit price to the estimated quantities included in the specifications.

20. Ethical Standards:

. It shall be a breach of ethics to offer, give or agree to give any elected official, department head or employee, or former elected official, department head or employee, of the County, or for any elected official, department head or employee or former elected official, department head or employee of the County, to solicit, demand, accept or agree to accept from another person, entity or organization, a gratuity or an offer of employment in connection with any decision, approval, disapproval, recommendation, preparation or any part of a program requirement or purchase request, influencing the content of any specification or procurement standard, rendering of advice, investigation, auditing, or in any other advisory capacity in any proceeding or application, request for ruling, determination, claim or controversy, or other particular matter pertaining to any program requirement or a contract or subcontract, or to any solicitation or proposal therefore pending before any department or agency of the County.

. It shall be a breach of ethics for any payment, gratuity or offer of employment to be made by or on behalf of a subcontractor under a contract to the prime contractor or higher tier subcontractor for any contract for the County, or any person associated therewith, as an inducement for the award of a subcontract or order.

. No public official shall have an interest in a contract awarded hereunder except in accordance with Tex. Loc. Govt. Code Chapter 171.

21. Disclosure of Conflict of Interest

. Effective January 1, 2006, Chapter 176 of the Texas Local Government Code requires that any vendor, person, consultant or contractor considering doing business with Hidalgo County ("the County") to disclose in the Conflict of Interest Questionnaire (the "CIQ") attached as Exhibit D, the vendor, person, consultant or contractor's affiliation or business relationship that might cause a conflict of interest with the County. By law, the CIQ must be filed with the Hidalgo County Clerk's Office no later than the seventh business day after the date the person becomes aware of facts that require that statement to be filed. The disclosure requirement applies to a person or business who contracts or seeks to contract with Hidalgo County for the sale or purchase of property, goods or service. Any purchase order or contract resulting from this process shall be considered null and void if the successful bidder fails to comply with Texas Local Government Code Chapter 176. Vendors, consultants, contractors and others who desire to conduct business with Hidalgo County are encouraged to refer to Texas Local Government Code Chapter 176 for the details of this law. An offense under Texas Local Government Code Chapter 176 is a Class C Misdemeanor.

Please Submit completed CIQ forms to the Hidalgo County Clerk's Office located at 100 N. Clossner, Edinburg, Texas 78539-Hidalgo County Courthouse  
**COMPLETION AND SUBMISSION OF FORM CIQ IS THE SOLE RESPONSIBILITY OF THE PROSPECTIVE BIDDER.**

22. If, during the life of any contract or bid awarded, the successful bidder's net prices generally available to other customers for items awarded herein are reduced below the contracted price, it is understood and agreed that the benefits of such reduction shall be extended to County.
23. Bids, and all goods and services provided thereunder, shall comply with all federal, state and local laws concerning this type(s) of goods and/or services.
24. Minimum Standards For Responsible Prospective Bidders: A prospective bidder must affirmatively demonstrate bidder's responsibility. A prospective bidder, by submitting a bid, represents to County that it meets the following requirements:
  - . Possess or is able to obtain adequate financial resources as required to perform under the bid;
  - . Be able to comply with the required or proposed delivery schedule;
  - . Have a satisfactory record of performance;
  - . Have a satisfactory record of integrity and ethics;
  - . Be otherwise qualified and eligible to receive an award.
25. Successful bidder will pay or cause to be paid, without cost or expenses to County, all FICA, FUTA/SUTA and Federal Income Withholding Taxes of all employees, and all wages and benefits as required by Federal or State law. Successful bidder's officers, agents and/or employees will not be entitled to any benefits of an employee or elected official of County, including, but not limited to, benefits associated with County's civil service system.
26. Any contract award to a successful bidder will be in effect until (a) the contract expires, (b) delivery and acceptance of products, and/or performance of services ordered, or (c) terminated by County with thirty day's written notice prior to cancellation.
27. County reserves the right to enforce performance of any contract awarded hereunder in any manner prescribed by law or deemed to be in the best interest of the County in the event of breach or default by successful bidder; County reserves the right to terminate any contract immediately in the event a successful bidder fails to:
  - A. Meet schedules;
  - B. Pay any required fees or taxes; or
  - C. Otherwise perform in accordance with the specifications.
28. Successful bidder shall defend, indemnify and save harmless County and all its elected officials, officers, agents and employees from all suits, actions, or other claims of any character, name and description brought for or on account of any injuries or damages received or sustained by any person, persons, or property on account of any negligent act

or fault of the successful bidder, or of any agent, employee, subcontractor or supplier of successful bidder in the execution of, or performance under, any contract which may result from bid award or which arises from any event or casualty happening on or within County premises themselves or happening upon or in any halls, elevators, entrances, stairways or approaches of or to such County facilities. Successful bidder shall pay any judgement with costs which may be obtained against County growing out of such injury or damages, and shall, upon request, provide a defense to County by counsel reasonably acceptable to County. Successful bidder's indemnity hereunder shall include, but is not limited to, claims relating to patent, copyright or trademark infringement, and the like, arising out of the goods and services provided by successful bidder.

29. Successful bidder shall warrant that all items/services shall conform with the specifications and/or all warranties provided under the Uniform Commercial Code and be free from all defects in material, workmanship and the like. Items supplied under a contract pursuant to this Request for Bids shall be subject to County's approval. Items found to be defective or not meeting specifications shall be replaced by successful bidder within two business days at no expense to County. Items not picked up within one (1) week after notification shall be deemed a donation to County and may be used or disposed of at County's discretion and without waiver of any other rights of County as to the item's nonconformity.
30. This document and any disputes arising hereunder shall be governed and construed according to the laws of the State of Texas, and will be performable exclusively in Hidalgo County, Texas.
31. The successful bidder shall not assign, sell, transfer or convey its rights under any awarded contract, in whole or in part, without the prior written consent of County.

**BIDDERS ACKNOWLEDGEMENT**  
Bid for  
**HIDALGO COUNTY PRECINCT NO. 3**  
**“ROAD AND DRAINAGE CONSTRUCTION FOR**  
**RANDOLPH BARNETT SUBDIVISION NO. 1”**  
**BID NO.: CAP-00-000-00-00-YSI**

To: Martha L. Salazar, CPPB, Purchasing Agent  
Hidalgo County Purchasing Department  
2812 S. Business Hwy. 281  
Edinburg, Texas 78539

**US Postal Mail/Courier Address**

**Hidalgo County New Administration Building**  
**2812 S Business Hwy 281**  
**Edinburg, Texas 78539**

**Physical Location:**

**Hidalgo County New Administration Building**  
**2802 S Business Hwy 281**  
**(Southeast of Canton Rd & Business 281**  
**Edinburg, Texas 78539)**

In accordance with the Specifications, and subject to all laws and regulations of the United States and state and local laws, the undersigned bidder proposes and commits to furnish all labor, equipment, material, software and services as set forth in the documents hereinbefore mentioned. The undersigned bidder further agrees, upon acceptance of its bid, to execute a contract and/or Purchase Order issued by Hidalgo County for performing and completing the work described in the Specifications within the time stated and for the prices proposed in the documents attached hereto and made a part hereof.

Bidder acknowledges receipt of all of the pages of the documents referenced in the Invitation to Bid Checklist presented in connection with this procurement. Bidder understands that Hidalgo County reserves the right to reject any or all bids and further reserves the right to design the evaluation criteria to be used in selecting the lowest and best bid.

Bidder agrees that this bid shall be good and may not be withdrawn for a period of ninety (90) calendar days after the scheduled closing time for receiving bids, as contained in the Specifications.

Respectfully submitted,

Bidder: \_\_\_\_\_

Address: \_\_\_\_\_

By: \_\_\_\_\_

Printed Name: \_\_\_\_\_

Title: \_\_\_\_\_

## INFORMATION FOR BIDDERS

### 1. Receipt and Opening of Bids

The Hidalgo County Pct # 3 (herein called the "Owner"), invites bids on the form attached hereto, all blanks of which must be appropriately filled in. Bids will be received by the Owner at the Hidalgo County Purchasing department until \_\_\_\_\_, \_\_\_\_\_,    at **9:30 a.m.** and then at said office publicly open and read aloud. The envelopes containing the bids must be sealed, addressed to Martha L. Salazar, Hidalgo County Purchasing Agent at 2812 S Business 281, Edinburg, Texas 78539 and designated as Bid for Hidalgo County Pct # 3 Border Colonia Access Program.

The owner may consider informal any bid not prepared and submitted in accordance with provisions hereof and may waive any informalities or reject any and all bids. Any bid may be withdrawn prior to the above scheduled time for the opening of bids or authorized postponement thereof. Any bid received after the time and date specified shall not be considered. No bidder may withdraw a bid within 60 days after the actual date of the opening thereof.

### 2. Preparation of Bid

Each bid must be submitted on the prescribed form and accompanied by Certification by Bidder Regarding Equal Employment Opportunity, Form, and Certification by Bidder (contractor), concerning Labor Standards and Prevailing Wage Requirements. All blank spaces for bid prices must be filled in, in ink or typewritten, in both words and figures, and the foregoing Certificates must be fully completed and executed when submitted.

Each bid must be submitted in a sealed envelopes bearing on the outside the name of the bidder, his address, and the name of the project for which the bid is submitted. If forwarded by mail, the sealed envelope containing the bid must be enclosed in another enveloped addressed as specified in the bid form.

### 3. Subcontracts

The bidder is specifically advised that any person, firm, or other party to whom is proposed to ward a subcontract under this contract –

- a Must be acceptable to the Owner after verification of the current eligibility status, and,
- b Approval of the proposed subcontract award cannot be given by the Owner unless and until the proposed subcontractor has submitted the Certification and/or other evidence showing that it has fully complied with any reporting requirements to which it is or was subject. Although the bidder is not required to attach such Certification by proposed subcontractors to his bid, the bidder is here advised of this requirement so that appropriate action can be taken to prevent subsequent delay in subcontract awards.



## **9. Time of Completion and Liquidated Damages**

Bidder must agree to commence on or before a date to be specified in a Written "Notice to Proceed" of the Owner and to fully complete the project within \_\_\_\_ **consecutive calendar days** thereafter. Bidder must agree also to pay as liquidated damages, the sum of **\$250 for each consecutive calendar day** thereafter as hereinafter provided in the General Conditions.

## **10. Condition of Work**

Each bidder must inform himself fully of the conditions relating to the construction of the project and the employment of labor thereon. Failure to do so will not relieve a successful bidder of his obligation to furnish all material and labor necessary to carry out the provisions of his contract. Insofar as possible the contractor, in carrying out his work, must employ such methods or means as will not cause any interruption of or interference with work of any other contractor.

## **11. Addenda and Interpretations**

No interpretation of the meaning of the plans, specifications or other pre-bid documents will be made to any bidder orally.

Every request for such interpretation should be in writing addressed to **Javier Hinojosa Engineering Attn: Javier Hinojosa, P.E., 416 E. Dove Avenue, McAllen, Texas 78504** and to be given consideration must be received at least five days prior to the date fixed for the opening of bids. Any all such interpretations and any supplemental instructions will be in the form of written addenda to the specifications which, if issued, will mailed by certified mail with return receipt requested to all prospective bidders (at the respective addresses furnished for such purposes), not later than three days prior to the date fixed for the opening of bids. Failure of any bidder to receive any such addendum or interpretation shall not relieve such bidder from any obligation under his bid as submitted. All addenda so issued shall become part of the contract documents.

## **12. Security for Faithful Performance**

Simultaneously with his delivery of the executed contract; the contractor shall furnish a surety bond or bonds as security for faithful performance of this contract and for the payment of all persons performing labor on the project under this contract and furnishing materials in connection with this contract, as specified in the General Conditions included herein. The surety on such bond or bonds shall be a duly authorized surety company satisfactory to the Owner.

## **13. Power of Attorney**

Attorney-in-fact who sign bonds or contract bonds must file with each bond a certified and effectively dated copy of their power of attorney.

#### **14. Notice of Special Conditions**

Attention is particularly called to those parts of the contract documents and specification which deal with the following;

- a** Inspection and testing of materials
- b** Insurance requirements
- c** Wage rates
- d** States allowances

#### **15. Laws and Regulations**

The bidder's attention is directed to the fact that all applicable State laws, municipal ordinances, and the rules and regulations of all authorities having jurisdiction of the project shall apply to the contract throughout, and they will be deemed to be included in the contract the same as though herein written out in full.

#### **16. Method of Award – Lowest Qualified Bidder**

If at the time this contract is to be awarded, the lowest base bid submitted by a responsible bidder does not exceed the amount of funds then estimated by the Owner as available to finance the contract the contract will be awarded on the base bid only. If such bid exceeds such amount, the Owner may reject all bids or may award the contract on the base bid combined with such deductible alternates applied in numerical order in which they are listed in the form of Bid, as produces a net amount which is within the available funds.

#### **17. Obligation of Bidder**

At the time of the opening of bids each bidder will be presumed to have inspected the site and to have read and to be thoroughly familiar with the plans and contract documents (including all addenda). The failure or omission of any bidder to examine any form, instrument or document shall in no way relieve any bidder from any obligation in respect of his bid.

**Supplement to Form HUD-4238-B®  
INFORMATION FOR BIDDERS**

**18. SAFETY STANDARDS AND ACCIDENTS PREVENTION**

With respect to all work performed under this contract, the contractor shall:

- 1 Comply with the safety standards provision of applicable laws, building and construction codes and the “Manual of Accident Prevention in Construction” published by the Associates General Contractors or America, the requirements of the Occupational Safety and Health Act of 1970 (Public Laws 91-596), and the requirements of Title 29 of the Code of Federal Regulations, Section 1518 as published in the “Federal Register”, Volume 36, No 75, Saturday, April 17, 1971.
- 2 Exercise every precaution at all times for the prevention of accidents and the protection of persons (including employees) and property.
- 3 Maintain at his office or other well known place at the job site, all articles necessary for giving first aid to the injured, and shall make standing arrangements for the immediate removal to a hospital or a doctor’s care of persons (including employee), whom may be injured on the job site. In no case shall employee be permitted to work at a job site before the employer has made a standing arrangement for removal of injured person to a hospital or a doctor’s care.

## **SPECIAL PROVISIONS**

1. The County of Hidalgo reserves the right to partially award the contract in order to meet the budget.
2. It shall be the Contractor's responsibility to locate underground utilities, whether shown or not shown on the drawings, sufficiently in advance of operations to preclude damage to same.
3. Water, sewer, or other utility serves shall not be interrupted. Any damages to existing utilities will be Contractor's responsibility.
4. In the event of damage to underground facilities, whether shown or not shown in the drawings, the Contractor shall make the necessary repairs to place the facilities back in service at no increase in the Contractor's price and all such repairs shall conform to the requirements of the company or agency servicing the facility
5. The Contractor shall exercise extra care to prevent damage to all other structures in the area including, fence, roads, pipelines, utilities, etc., whether publicly or privately owned.
6. Until acceptance by the Engineer of any part or all of the construction, as provided for in the plans and these specifications, it shall be under the charge and care of the contractor, and he shall take every necessary precaution against injury or damage to any part of the work. The Contractor shall rebuild, repair, restore and make good, at his own expense, all injuries or damage to any portion of the work before its completion and acceptance.
7. In case the Contractor deems extra compensation is due him for proposed work not covered in the contract, the Contractor shall notify the Engineer in writing of his claim for such extra compensation before he begins the work. Failure on the part of the Contractor to give such notification shall constitute a waiver of claim for such extra compensation. The Contractor shall not proceed until a written Change Order is approved by the Owner, Engineer, and Contractor.
8. Prospective bidders should make a careful examination of the projects sites.
9. Contractor shall review his overall method and schedule of construction with the County Prior to construction for proper coordination of inspection.
10. No open trenches or excavation shall be left open overnight.
11. Adjustment of Sanitary Sewer manholes to be incidental to price bid for Flex Base.
12. Relocation of all mailboxes to be considered incidental to price bid for Right of Way Preparation.

# BID FORM

Company Name:	_____
Signature:	_____
Printed Name:	_____

**BID FORM**  
**HIDALGO COUNTY PRECINCT NO. 3**  
**BORDER COLONIA ACCESS PROJECT**  
**CAP-00-000-00-00-YSI**

**ROAD AND DRAINAGE CONSTRUCTION FOR RANDOLPH BARNETT SUBDIVISION NO. 1**

**BID ITEMS FOR ROAD CONSTRUCTION**

TXDOT Item No.	Est Quantity	Unit	Item Description	Unit Bid Price In Words	Unit Price In Figures	Total Extension In Figures
-------------------	-----------------	------	------------------	----------------------------	--------------------------	-------------------------------

**PAVING**

100	6.39	STA	Preparing ROW	Dollars	\$	\$
				Cents		
110	2160	SY	Reworking BS Matl (DC) (TY D 6")	Dollars	\$	\$
				Cents		
247	2160	SY	8" Flex Base (Compl in place) (TY E GR 4)	Dollars	\$	\$
				Cents		
310	432	GAL	ASPH Matrl (MC-30)	Dollars	\$	\$
				Cents		
340	1858	SY	ASPH Conc (TY D)(1 1/2")	Dollars	\$	\$
				Cents		
502	2	MO	Barricades, Sign and Traffic Handling	Dollars	\$	\$
				Cents		
530	30	SY	Turnouts (ASPH-CONC- PAV)(PB-2)	Dollars	\$	\$
				Cents		
		LUMP	Relocate Mailboxes	Dollars	\$	\$
		SUM		Cents		

Roadway	\$
Subtotal	

Company Name:	_____
Signature:	_____
Printed Name:	_____

**DRAINAGE**

530	454	SY	Driveway (ASPH-CON-PAV) (PB-1)	Dollars	\$	\$
				Cents		
530	153	SY	Driveway (Concrete 3000 PSI)	Dollars	\$	\$
				Cents		
473	600	LF	15" ADS Culvert Pipe	Dollars	\$	\$
				Cents		
464	70	LF	18" RCP Culvert	Dollars	\$	\$
				Cents		
467	2	EA	Safety End Treatments	Dollars	\$	\$
				Cents		
506	300	LF	Temporary Sediment Control Fence	Dollars	\$	\$
				Cents		
506	300	LF	Temporary Sediment Control Fence (Remove)	Dollars	\$	\$
				Cents		

Drainage	\$
Subtotal	

<b>Bid Total</b>	<b>\$</b>
------------------	-----------

BIDDER/COMPANY NAME: \_\_\_\_\_

AUTHORIZED SIGNATURE: \_\_\_\_\_

PRINTED NAME: \_\_\_\_\_

TITLE: \_\_\_\_\_

Company Name:	_____
Signature:	_____
Printed Name:	_____

**CONTINUATION OF BID PACKAGE**

The undersigned **Bidder** agrees to commence work after written notice to commence work and to substantially complete the work on which he has bid within **calendar days** as provided in Article 18 of the General Conditions of the Agreement.

Enclosed with this Proposal is a Cashier's check or Certified Check for \_\_\_\_\_ Dollars ( \_\_\_\_\_ ) or a Bid Bond in the Sum of \_\_\_\_\_ Dollars ( \_\_\_\_\_ ), which is agreed shall be collected and retained by the **Owner** under the Conditions hereof within ten (10) days after the date this proposal is accepted; then otherwise the said bond or check shall be returned to the undersigned upon demand.

Receipts of the following Addenda on these dates shown is acknowledged:

DATE	ACKNOWLEDGE	DATE	ACKNOWLEDGE
#1 _____		#2 _____	
#3 _____		#4 _____	

Respectfully submitted,

\_\_\_\_\_  
Name of Firm

By: \_\_\_\_\_  
Signature                      Date

**THIS PROPOSAL MUST BE  
SIGNED BY AN OFFICER OR  
REPRESENTATIVE DULY  
AUTHORIZED BY THE BIDDER**

\_\_\_\_\_  
Title

\_\_\_\_\_  
Address

(Seal, if Bid is by a Corporation)

\_\_\_\_\_  
Telephone Number

Attest: \_\_\_\_\_

Company Name:	_____
Signature:	_____
Printed Name:	_____

**HIDALGO COUNTY PRECINCT #3 BORDER ACCESS COLONIA PROJECT**

**BID BOND**

KNOW ALL MEN BY THESE PRESENTS, That we, the undersigned \_\_\_\_\_  
\_\_\_\_\_ as Principal, and \_\_\_\_\_  
\_\_\_\_\_ as Surety, are hereby held and firmly bound  
unto \_\_\_\_\_ as OWNER in the penal sum of \_\_\_\_\_

for the payment of which, well and truly to be made, we hereby jointly and severally bind ourselves, successors and assigns.

Signed, this \_\_\_\_\_ day of \_\_\_\_\_, 20\_\_\_\_\_.

The condition of the above obligation is such that whereas the Principal has submitted to \_\_\_\_\_  
\_\_\_\_\_ a certain BID, attached hereto and  
hereby made a part hereof to enter into a contract in writing for the

\_\_\_\_\_  
\_\_\_\_\_  
\_\_\_\_\_  
\_\_\_\_\_

NOW, THEREFORE,

- (a) If said Bid shall be rejected, or
- (b) If said Bid shall be accepted and the Principal shall execute and deliver a contract in the Form of Contract attached hereto (properly completed in accordance with said BID) and Shall furnish a BOND for his faithful performance of said contract, and for the payment of all persons performing labor or furnishing materials in connection therewith, and shall in all other respects perform the agreement created by the acceptance of said BID, then, this obligation shall be void, otherwise the same shall remain in force and effect; it being expressly understood and agreed that the liability of the Surety for any and all claims hereunder shall, in no event, exceed the penal amount of this obligation is herein stated.

The Surety, for value received, hereby stipulates and agrees that the obligations of said Surety and its BOND shall be in no way impaired or affected by any extension of the time within which the OWNER may accept such Bid; and said Surety does hereby waive notice of any such extension.

IN WITNESS WHEREOF, the Principal and the Surety have hereunto set their hands and seals, and such of them as are corporations have caused their corporate seals to be hereto affixed and these presents to be signed by their proper officers, the day and year first set forth above.

\_\_\_\_\_(L.S.)  
Principal

\_\_\_\_\_  
Surety

By: \_\_\_\_\_

IMPORTANT – Surety companies executing BONDS must appear on the Treasury Department’s most current list (circular 570 as amended) and be authorized to transact business in the state where the project is located.

THE STATE OF TEXAS §  
§  
COUNTY OF HIDALGO §

CONSTRUCTION CONTRACT  
C-CAP-00-000-00-00-XXX

This Agreement, entered into this \_\_\_\_\_ day of \_\_\_\_\_, [red box] by and between Hidalgo County (hereinafter called the "OWNER," and, \_\_\_\_\_ (a Texas Corporation), of County of Hidalgo, and State of Texas, hereinafter called "CONTRACTOR".

WITNESSETH

That for and in consideration of the payments and agreement hereinafter mentioned, to be made and performed by the OWNER, the CONTRACTOR hereby agrees with the OWNER to commence and complete the construction described as follows:

RANDOLPH BARNETT SUBDIVISION NO. 1

Hereinafter called the project, for the sum of (\$ \_\_\_\_\_ ) \_\_\_\_\_ and \_\_\_\_\_ Cents and all extra work in connection therewith, under the terms and stated in the General and Special Conditions of the Contract; and at his (its or their) own proper cost and expense to furnish all the materials, supplies, machinery, equipment, tools, superintendence, labor, insurance, and other accessories and services necessary to complete the said project in accordance with the conditions and prices stated in the Proposal, the General Conditions and Special Conditions printed or written explanatory matter thereof, the specifications and contract documents therefore as prepared by Javier Hinojosa Engineering, entitled the Architect/Engineer, and as enumerated in Paragraph 1.01.A.12 of the General Conditions, all of which are made a part hereof and collectively evidence and constitute the contract.

The CONTRACTOR hereby agrees to commence work under this contract on or after a date to be specified in written "Notice to Proceed" of the OWNER and to fully complete the project within \_\_\_\_\_ consecutive calendar days thereafter. The CONTRACTOR further agrees to pay, as liquidated damages, the sum of \$ 250.00 for each consecutive calendar day thereafter.

The OWNER agrees to pay the CONTRACTOR in current funds for the performance of the contract, subject to additions and deductions, as provided in the General Conditions of the contract, and to make payments on account thereof as provided in Paragraphs 14.02.C and 14.07.C of the General Conditions.

IN WITNESS WHEREOF, the parties to these present have executed this contract in four (4) counterparts, each of which shall be deemed an original, in year and day first above mentioned.

APPROVED BY COMMISSIONERS COURT ON, \_\_\_\_\_,

CONTRACTOR: \_\_\_\_\_  
Print Name & Title: \_\_\_\_\_  
Name of Firm: \_\_\_\_\_  
Address: \_\_\_\_\_  
\_\_\_\_\_   
Fed I.D. #/SS #: \_\_\_\_\_

STATE OF TEXAS

COUNTY OF HIDALGO

This instrument was acknowledged before me on this the \_\_\_\_\_ day of \_\_\_\_\_,  
2012, by \_\_\_\_\_ of and on behalf of \_\_\_\_\_.  
(Name & Title) (A corporation)

\_\_\_\_\_  
Notary Public-Signature

APPROVED AS TO FORM:  
Atlas & Hall, L.L.P.  
800 Pecan  
McAllen, Texas 78504

BY: \_\_\_\_\_

ATTEST:

COUNTY OF HIDALGO:

\_\_\_\_\_  
Arturo Guajardo, Jr., County Clerk

\_\_\_\_\_  
Ramon Garcia, County Judge

**NON-COLLUSION AFFIDAVIT OF PRIME BIDDER**

State of .....

County of.....

\_\_\_\_\_, being first duly sworn,  
deposes and says that:

(1) He is \_\_\_\_\_, of  
\_\_\_\_\_, the Bidder that has submitted the attached Bid;

(2) He is fully informed respecting the preparation and contents of this attached bid and of all pertinent circumstances respecting such bid;

(3) Such bid is genuine and is not a collusive or sham Bid;

(4) Neither the said Bidder nor any of its officers, partners, owners, agents, representative:, employees or parties in interest, including this affiant, has in any way colluded, conspired a collusive or sham Bid in connection with the Contract for which the attaché Bid has been submitted or to refrain from bidding in connection with such Contract, or has in any manner, directly or indirectly, sought by agreement or collusion or communication of conference with any other Bidder, firm or person to fix the price or prices in the attached Bid or of any other Bidder, or to fix any overhead, profit or cost element of the Bid price or the Bid price of any other Bidder, or to secure through any collusion, conspiracy, connivance or unlawful agreement any advantage against the Owner or any person interested in the proposed Contract; and

(5) The price or prices quoted in the attached Bid are fair and proper and are not tainted by any collusion, conspiracy, connivance, connivance or unlawful agreement on the part of the Bidder or any of its agents, representatives, owners, employees, or parties in interest, including this affiant.

(Signed) \_\_\_\_\_

\_\_\_\_\_  
(Title)

Subscribed and sworn to before me on this \_\_\_\_\_

Day of \_\_\_\_\_

\_\_\_\_\_

\_\_\_\_\_

Title

**PAYMENT BOND**

(To be used in Texas under V.A.T.S. 5160)

THE STATE OF \_\_\_\_\_

COUNTY OF \_\_\_\_\_

KNOW ALL MEN BY THESE PRESENTS: That we (1) \_\_\_\_\_,  
a (2) \_\_\_\_\_, hereinafter called  
Principal and (3) \_\_\_\_\_ of  
\_\_\_\_\_, hereinafter called the  
Surety, are held and firmly bound unto (4) \_\_\_\_\_ of  
\_\_\_\_\_, hereinafter called Owner, and unto all persons,  
firms, and corporations who may furnish materials for, or perform labor  
upon the building or improvements hereinafter referred to the penal sum  
of \_\_\_\_\_ (\$ \_\_\_\_\_) Dollars in lawful money of the  
United States to be paid in (5) \_\_\_\_\_, for the  
payment of which sum well and truly to be made, we bind ourselves, our  
heirs, executors, administrators, and successors, jointly and severally,  
firmly be these presents.

THE CONDITION OF THIS OBLIGATION is such that Whereas, the Principal  
entered into a certain contract with (6) \_\_\_\_\_,  
\_\_\_\_\_, the Owner, dated  
the \_\_\_\_\_ day of \_\_\_\_\_, A.D. 200\_\_\_\_, a copy of which is  
hereto attached and made a part hereof for the construction of:

**HIDALGO COUNTY PRECINCT #3 BORDER ACCESS COLONIA PROJECT  
ROAD AND DRAINAGE CONSTRUCTION FOR RANDOLPH BARNETT  
SUBDIVISION NO. 1**

These footnotes refer to numbers in body of contract above:

Date of Bond must not be prior to date of contract

- (1) Correct name of Contractor
- (2) A Corporation, a Partnership or an Individual, as case may be
- (3) Correct name of Surety
- (4) Correct name of Owner
- (5) County and State
- (6) Owner

NOW, THEREFORE, the condition of this obligation is such that, if the  
-1- Principal shall promptly make payment to all claimants as defined  
in Article 5160 Revised Civil Statutes of Texas, 1925, as amended by  
House Bill 344, Act 56<sup>th</sup> Legislature, Regular Session, 1925 effective  
April 27, 1959, supplying labor and materials in the prosecution of  
the work provided for in said Contract, then this obligation shall be  
null and void, otherwise it shall remain in full force and effect.

This bond is made and entered into solely for the prosecution of all  
claimants supplying labor and material in the prosecution of the work  
provided for in said Contract, and all such claimants shall have a  
direct right of action under the bond as provided in Article 5160,  
Revised Civil Statutes 1925, as amended by House Bill 344, Acts 56<sup>th</sup>  
Legislature, Regular Session, 1959

PROVIDED FURTHER, that if any legal action be filed upon this bond, venue shall lie in Hidalgo County, State of Texas, and that the said surety, for value received hereby stipulates and agrees that no change, extension of time, alteration or addition to the terms of the contract or to the work to be performed thereunder or the specification accompanying the same shall in any way affect its obligation on this bond, and it does hereby waive notice of any such change, extension of time, alteration or addition to the terms of the contract or to the work or to the specifications.

PROVIDED FURTHER, that no final settlement between the Owner and the Contractor shall abridge the right of any beneficiary hereunder, whose claim may be unsatisfied.

IN WITNESS WHEREOF, this instrument is executed in six counterparts, each one of which shall be deemed an original, this the \_\_\_\_\_ day of \_\_\_\_\_ . A.D., 200\_\_\_\_\_.

ATTEST:

\_\_\_\_\_  
(Principal) Secretary

(Seal)

\_\_\_\_\_  
Witness as to Principal

\_\_\_\_\_  
(Address)

Principal \_\_\_\_\_  
By \_\_\_\_\_

(Address) \_\_\_\_\_

Telephone Number: \_\_\_\_\_

\_\_\_\_\_  
Surety

ATTEST:

\_\_\_\_\_  
(Surety) Secretary

(Seal)

\_\_\_\_\_  
Witness as to Surety

\_\_\_\_\_  
(Address)

By \_\_\_\_\_

(Address) \_\_\_\_\_

NOTE: If Contractor is partnership all Partners should execute bond

Telephone Number: \_\_\_\_\_

**PAYMENT BOND FORM**

\_\_\_\_\_  
\_\_\_\_\_  
(Address)  
Telephone Number: \_\_\_\_\_

\_\_\_\_\_  
(Individual Principal)  
\_\_\_\_\_  
(Business Address)  
Telephone Number: \_\_\_\_\_

\_\_\_\_\_  
(Corporate Principal)

\_\_\_\_\_  
(Business Address) (Affix Corporate SEAL)  
Telephone Number: \_\_\_\_\_  
BY \_\_\_\_\_

\_\_\_\_\_  
ATTEST:

\_\_\_\_\_  
\_\_\_\_\_

\_\_\_\_\_  
(Business Address) (Affix Corporate SEAL)  
BY \_\_\_\_\_  
Telephone Number: \_\_\_\_\_

**CERTIFICATES AS TO CORPORATE PRINCIPAL**

I, \_\_\_\_\_, certify that I am the \_\_\_\_\_  
Secretary of the corporation named as Principal in the within bond; that  
\_\_\_\_\_, who signed the said bond on behalf of the  
Principal was then \_\_\_\_\_ of said corporation; and I  
know his signature, and his signature thereto is genuine; and that said  
bond was duly signed, sealed, and attested for and in behalf of said  
corporation by authority of its governing body.

\_\_\_\_\_  
(TITLE)  
DATE \_\_\_\_\_

\_\_\_\_\_  
(AFFIX CORPORATE SEAL)

Telephone Number: \_\_\_\_\_

The rate of premium on this bond is \_\_\_\_\_ per thousand. Total  
amount of premium charge \$ \_\_\_\_\_.  
(The above must be filled in by corporate surety.) (Power-of-Attorney of  
person signing for surety company must be attached.)

**PERFORMANCE BOND**  
**(To be used in Texas under V.A.T.S. 5160)**

THE STATE OF \_\_\_\_\_

COUNTY OF \_\_\_\_\_

KNOW ALL MEN BY THESE PRESENTS: That we (1) \_\_\_\_\_, a (2) \_\_\_\_\_ OF \_\_\_\_\_, hereinafter called Principal and (3) \_\_\_\_\_ of \_\_\_\_\_, State of \_\_\_\_\_, hereinafter called the Surety, are held and firmly bound unto (4) \_\_\_\_\_ of \_\_\_\_\_, hereinafter called Owner, in the penal sum of \_\_\_\_\_ (\$ \_\_\_\_\_) Dollars in lawful money of the United States to be paid in (5) \_\_\_\_\_, for the payment of which sum well and truly to be made, we bind ourselves, our heirs, executors, administrators, and successors, jointly and severally, firmly be these presents.

THE CONDITION OF THIS OBLIGATION is such that Whereas, the Principal entered into a certain contract with (6) \_\_\_\_\_, the Owner, dated the \_\_\_\_\_ day of \_\_\_\_\_, A.D. 200\_\_, a copy of which is hereto attached and made a part hereof for the construction of:

**HIDALGO COUNTY PRECINCT #3 BORDER ACCESS COLONIA PROJECT**  
**ROAD AND DRAINAGE CONSTRUCTION FOR**  
**RANDOLPH BARNETT SUBDIVISION NO. 1**

hereinafter called the "Work").

---

---

These footnotes refer to the numbers in body of contract above:

Date of Bond must not be prior to date of contract

- (1) Correct name of Contractor
- (2) A Corporation, a Partnership or an Individual, as case may be
- (3) Correct name of Surety
- (4) Correct name of Owner
- (5) County and State
- (6) Owner

(Texas Performance Bond) - Page 2.

NOW, THEREFORE, if the Principal shall well, truly and faithfully perform the work in accordance with the plans, specifications, and contract documents during the original term thereof, and any extensions thereof which may be granted by the Owner, with or without notice to the Surety, and if he shall satisfy all claims and demands incurred under such contract, and shall fully indemnify and save harmless the Owner from all costs and damages which it may suffer by reason of failure to do so, and shall reimburse and repay the Owner all outlay and expense which the Owner may incur in making good any default, then this obligation shall be void; otherwise to remain in full force and effect.

PROVIDED FURTHER, that if any legal action be filed upon this bond, venue shall lie in Hidalgo County, State of Texas, and that the said surety, for value received hereby stipulates and agrees that no change, extension

of time, alteration or addition to the terms of the contract or to the work to be performed thereunder or the specifications accompanying the same shall in any way affect its obligation on this bond, and it does hereby waive notice of any such change, extension of time, alternation or addition to the terms of the contract or to the work or to the specifications.

IN WITNESS WHEREOF, this instrument is executed in six counterparts, each one of which shall be deemed an original, this the \_\_\_\_\_ day of \_\_\_\_\_ . A.D.

ATTEST:

\_\_\_\_\_  
(Principal) Secretary

(Seal)

\_\_\_\_\_  
Witness as to Principal

\_\_\_\_\_  
(Address)

Principal \_\_\_\_\_

By \_\_\_\_\_

(Address) \_\_\_\_\_

Telephone Number: \_\_\_\_\_

ATTEST:

\_\_\_\_\_  
(Surety) Secretary

(Seal)

\_\_\_\_\_  
Witness as to Surety

\_\_\_\_\_  
(Address)

By \_\_\_\_\_

(Address) \_\_\_\_\_

Telephone Number: \_\_\_\_\_

NOTE: If Contractor is a partnership, all partners should execute bond.

**PERFORMANCE-PAYMENT BOND FORM**

\_\_\_\_\_  
\_\_\_\_\_  
(Address)  
Telephone Number: \_\_\_\_\_

\_\_\_\_\_  
(Individual Principal)  
\_\_\_\_\_  
(Business Address)  
Telephone Number: \_\_\_\_\_

\_\_\_\_\_  
(Corporate Principal)

\_\_\_\_\_  
(Business Address) (Affix Corporate SEAL)  
Telephone Number: \_\_\_\_\_  
BY \_\_\_\_\_

\_\_\_\_\_  
ATTEST:

\_\_\_\_\_  
(Business Address) (Affix Corporate SEAL)  
BY \_\_\_\_\_  
Telephone Number: \_\_\_\_\_

**CERTIFICATES AS TO CORPORATE PRINCIPAL**

I, \_\_\_\_\_, certify that I am the \_\_\_\_\_  
Secretary of the corporation named as Principal in the within bond; that  
\_\_\_\_\_, who signed the said bond on behalf of the  
Principal was then \_\_\_\_\_ of said corporation; and I  
know his signature, and his signature thereto is genuine; and that said  
bond was duly signed, sealed, and attested for and in behalf of said  
corporation by authority of its governing body.

\_\_\_\_\_  
(TITLE)  
DATE \_\_\_\_\_

\_\_\_\_\_  
(AFFIX CORPORATE SEAL)

Telephone Number: \_\_\_\_\_

The rate of premium on this bond is \_\_\_\_\_ per thousand. Total  
amount of premium charge \$ \_\_\_\_\_.  
(The above must be filled in by corporate surety.) (Power-of-Attorney of  
person signing for surety company must be attached.)

## **EXHIBIT "C"**

### **Insurance Requirements**

The Bidder awarded the contract shall furnish proof of insurance, which will also include any subcontractor that is subcontracted by the bidder in at least the following limits, to be in place prior to providing any services under this Contract and to continue at all times in force in effect during the term of this Contract:

1. A Five Hundred Thousand Dollar (\$500,000.00) Comprehensive General Liability insurance policy providing additional coverage to all underlying liabilities of County.
2. Automobile liability insurance policy with limits of at least Three Hundred Thousand Dollars (\$300,000.00) per person and Five Hundred Thousand Dollars (\$500,000.00) per occurrence. Coverage should include injury to or death of persons and property damage claims with limits up to Five Hundred Thousand (\$500,000.00) arising out of the services provided to County hereunder.
3. Uninsured/Underinsured motorist coverage in an amount equal to the bodily injury limits set forth immediately above;
4. Workers compensation insurance in amounts established by Texas law, unless the Bidder is specifically exempted from the Texas Workers Compensation Act, Texas Labor Code Chapter 401, et. seq.

Certificates of insurance naming County as an additional insured shall be submitted to County for approval prior to any services being performed by Contractor. Each policy of insurance required hereunder shall extend for a period equivalent to, or longer than the term of the Contract, and any insurer hereunder shall be required to give at least thirty (30) days written notice to the County prior to the cancellation of any such coverage on the termination date, or otherwise. This Contract shall be automatically suspended upon the cancellation, or other termination, of any required policy of insurance hereunder, and such suspension shall continue until evidence adequate replacement coverage is provided to County. If replacement coverage is not provided within thirty (30) days following suspension of the Contract, this Contract shall automatically terminate.

# Insurance Requirement Acknowledgment

I, \_\_\_\_\_, authorized representative for \_\_\_\_\_,  
Company/Vendor

hereby acknowledge receipt of the County's required insurance limits. Said requirements:

- will be acquired within 10 working days after notification from Purchasing Department of bid awarded by the Hidalgo County Commissioners' Court;
- will acquire additional amounts required to meet the County's requirements within 10 working days after notification from Purchasing Department of bid award by the Hidalgo County Commissioners' Court; currently carry the following:

Automobile Liability: \$ \_\_\_\_\_ General Liability: \$ \_\_\_\_\_

- have already been met, see attached copy of insurance certificate.

\_\_\_\_\_  
Authorized Representative

\_\_\_\_\_  
Date

**Notice to Bidder:**

A certificate of insurance for the required insurance limits shall be provided to the Purchasing Department's Contract Managers in order to qualify for award of bid and to execute a contract between your Company and the County

Failure to provide Certificates of Insurance to the Purchasing Department's Contract Managers will cause the bid award to be rescinded and re-awarded to next lowest bidder. Certificates of Insurance will be monitored and verified on a **quarterly basis** to ensure coverage policy is in place. It is the Company's obligation to maintain the appropriate insurance coverage throughout the term of the contract.

**THIS FORM MUST ACCOMPANY BID PACKET**

## PROJECT REQUIREMENTS ACKNOWLEDGMENT

This is to certify that I, \_\_\_\_\_, possess all of the APPLICABLE:

1. Licenses: \_\_\_\_\_.
2. Bonds: \_\_\_\_\_.
3. Certificates: \_\_\_\_\_.
4. Permits: \_\_\_\_\_.
5. Other: \_\_\_\_\_.

necessary to carry out the required project. Furthermore, I am providing copies of the required documentation so that, if my company is awarded this bid, I may be eligible to enter into a contract with Hidalgo County and proceed to complete the project in a timely manner.

\* Any licenses, bonds, certificates, permits, etc. which are required must be presented as part of the bid packet in order to expedite the bid evaluation process. Failure to provide said documentation will result in the disqualification of your bid.

\_\_\_\_\_  
Authorized Signature

\_\_\_\_\_  
Date

\_\_\_\_\_  
Company

\_\_\_\_\_  
Address

\_\_\_\_\_  
City, State, Zip

PRODUCER

THIS CERTIFICATE IS ISSUED AS A MATTER OF INFORMATION ONLY AND CONFERS NO RIGHTS UPON THE CERTIFICATE HOLDER. THIS CERTIFICATE DOES NOT AMEND, EXTEND OR ALTER THE COVERAGE AFFORDED BY THE POLICIES BELOW.

### INSURERS AFFORDING COVERAGE

INSURED

INSURER A:

INSURER B:

INSURER C:

INSURER D:

INSURER E:

### COVERAGES

THE POLICIES OF INSURANCE LISTED BELOW HAVE BEEN ISSUED TO THE INSURED NAMED ABOVE FOR THE POLICY PERIOD INDICATED. NOTWITHSTANDING ANY REQUIREMENT, TERM OR CONDITION OF ANY CONTRACT OR OTHER DOCUMENT WITH RESPECT TO WHICH THIS CERTIFICATE MAY BE ISSUED OR MAY PERTAIN, THE INSURANCE AFFORDED BY THE POLICIES DESCRIBED HEREIN IS SUBJECT TO ALL THEIR TERMS, EXCLUSIONS AND CONDITIONS OF SUCH POLICIES. AGGREGATE LIMITS SHOWN MAY HAVE BEEN REDUCED BY PAID CLAIMS.

INSR LTR	TYPE OF INSURANCE	POLICY NUMBER	POLICY EFFECTIVE DATE (MM/DD/YY)	POLICY EXPIRATION DATE (MM/DD/YY)	LIMITS
A	<b>GENERAL LIABILITY</b>				EACH OCCURRENCE \$
	<input type="checkbox"/> COMMERCIAL GENERAL LIABILITY				FIRE DAMAGE (Any one fire) \$
	<input type="checkbox"/> CLAIMS MADE <input type="checkbox"/> OCCUR				MEDICAL (Any one person) \$
	<input type="checkbox"/> OWNER'S & CONT. PROT				PERSONAL & ADV INJURY \$
	<input type="checkbox"/> OWNER'S PROTECTIVE LIABILITY				ANNUAL AGGREGATE \$
	<input type="checkbox"/> GEN'L AGGREGATE LIMIT APPLIES PER: POLICY <input type="checkbox"/> PROJECT <input type="checkbox"/> LOC				PRODUCTS - COMP/OP \$
B	<b>AUTOMOBILE LIABILITY</b>				COMBINED SINGLE LIMIT (Ea accident) \$
	<input type="checkbox"/> ANY AUTO				BODILY INJURY (Per person) \$
	<input type="checkbox"/> ALL OWNED AUTOS				BODILY INJURY (Per accident) \$
	<input type="checkbox"/> SCHEDULED AUTOS				PROPERTY DAMAGE (Per accident) \$
	<input type="checkbox"/> HIRED AUTOS				
<input type="checkbox"/> NON-OWNED AUTOS					
	<b>GARAGE LIABILITY</b>				AUTO ONLY-EA ACCIDENT \$
	<input type="checkbox"/> ANY AUTO				OTHER THAN AUTO ONLY EA ACC AGG \$
C	<b>EXCESS LIABILITY</b>				EACH OCCURRENCE \$
	<input type="checkbox"/> OCCUR <input type="checkbox"/> CLAIMS MADE				AGGREGATE \$
	<input type="checkbox"/> DEDUCTIBLE				\$
	<input type="checkbox"/> RETENTION \$				\$
D	<b>WORKERS COMPENSATION AND EMPLOYER'S LIABILITY</b>				WC STATUTORY LIMITS <input type="checkbox"/> OTHER \$
					E.L. EACH ACCIDENT \$
					E.L. DISEASE-EA EMPLOYEE \$
					E.L. DISEASE-POLICY LIMIT \$
	<b>OTHER</b>				

DESCRIPTION OF OPERATIONS / LOCATION / VEHICLES / EXCLUSIONS ADDED BY ENDORSEMENT / SPECIAL PROVISIONS

County of Hidalgo shall be named as additional insured on all Commercial General Liability policies.

CERTIFICATE HOLDER

ADDITIONAL INSURED; INSURER LETTER: \_\_\_\_\_ CANCELLATION

Hidalgo County  
2812 S Highway Bus. 281  
Edinburg, Texas 78539

SHOULD ANY OF THE ABOVE DESCRIBED POLICIES BY CANCELLED BEFORE THE EXPIRATION DATE THEREOF, THE ISSUING INSURER WILL ENDEAVOR TO MAIL **30** DAYS WRITTEN NOTICE TO THE CERTIFICATE HOLDER NAMED TO THE LEFT, BUT FAILURE TO DO SO SHALL IMPOSE NO OBLIGATION OR LIABILITY OF ANY KIND UPON THE INSURER, ITS AGENTS OR REPRESENTATIVES.  
AUTHORIZED REPRESENTATIVE

## **GENERAL CONDITIONS OF THE AGREEMENT**

### **1. GENERAL**

It is the intent of these instructions, plans and specifications to provide guidance for the construction of this project.

### **2. REGULATIONS AND DISCREPANCIES**

All applicable laws, ordinances, policy, rules, regulations and other directives of all authorities having jurisdiction over the projects shall apply to the contract throughout and will be deemed to be included in the contract the same as those written out in full. Discrepancies between regulations or conflicting parts of the Specifications shall be brought to the attention of an clarified by the Engineer before proceeding with any work. Proceeding with affected work without instructions from the Engineer can result in the Contractor being responsible for taking the necessary steps to insure the work conforms to the governing regulation.

### **3. ENGINEER**

Whenever the work "ENGINEER" is used in this contract with reference to the preparation of plans, specifications, and contract documents, it shall be understood as referring to the firm **Javier Hinojosa Engineering**.

### **4. INTERPRETATION OF PHRASES**

Whenever the words "Directed", "Required", "Permitted", "Designated", "Considered Necessary", "Prescribed", or words of like importance are used, it shall be understood that the direction, requirements, permission, order, designation or prescription, of the ENGINEER is intended and similarly, the words "Approval", "Acceptable", "Satisfactory", or words of like importance shall mean approved by or acceptable of satisfactory to the ENGINEER. The preceeding to the contrary notwithstanding, Engineer's approval or acceptance of the work shall by advisory to OWNER, and shall not bind the OWNER to accept or approve the same.

Whenever, in the specifications or drawings accompanying this agreement, the terms or description of various qualities relative to finish, workmanship, or other qualities of similar kind which cannot,, from their nature, be specifically and clearly described and specified, but are necessarily described in general terms, then, in all such cases, any question of the fulfillment of said specifications shall be decided by the ENGINEER, and said work shall be done in accordance with his interpretations of the meaning of the words, terms, or clauses defining the character of the work.

# Title 29 - LABOR

## Subtitle A - Office of the Secretary of Labor

### PART 3 - CONTRACTORS AND SUBCONTRACTORS ON PUBLIC BUILDING OR PUBLIC WORK FINANCED IN WHOLE OR IN PART BY LOANS OR GRANTS FROM THE UNITED STATES

- Sec.
- 3.1 Purpose and scope
  - 3.2 Definitions
  - 3.3 Weekly statement with respect to payment of wages
  - 3.4 Submission of weekly statements and the preservation and inspection of weekly payroll records.
  - 3.5 Payroll deductions permissible without application to or approval of the Secretary of Labor.
  - 3.6 Payroll deductions permissible with the approval of the Secretary of Labor.
  - 3.7 Applications for the approval of the Secretary of Labor
  - 3.8 Action by the Secretary of Labor upon applications.
  - 3.9 Prohibited payroll deductions.
  - 3.10 Methods of payment of wages.
  - 3.11 Regulations part of contract.

**AUTHORITY:** The provisions of this Part 3 issued under R.S. 16 1, sec. 2, 48 Stat. §48; Reorg. Plan No. 14 of 1950, 64 Stat. 1267, 5 U.S.C. Appendix; 5 U.S.C. 301; 40 U.S.C. 276c.

**SOURCE:** The provisions of this Part 3 appear at 29 F.R. 97, Jan. 4, 1964, unless otherwise noted.

#### Section 3.1 Purpose and Scope.

This part prescribes "anti-kickback" regulations under section 2 of the Act of June 13, 1934, as amended (40 U.S.C. 276c), popularly known as the Copeland Act. This part applies to any contract which is subject to Federal wage standards and which is for the construction, prosecution, completion, or repair of public buildings, public works or buildings or works financed in whole or in part by loans or grants from the United States. The part is intended to aid in the enforcement of the minimum wage provisions of the Davis-Bacon Act and the various statutes dealing with Federally assisted construction that contain similar minimum wage provisions, including those provisions which are not subject to Reorganization

Plan No. 14 (e.g., the College Housing Act of 1950, the Federal Water Pollution Control Act, and the Housing Act of 1959), and in the enforcement of the overtime provisions of the Contract Work Hours Standards Act whenever they are applicable to construction work. The part details the obligation of contractors and subcontractors relative to the weekly submission of statements regarding the wages paid on work covered thereby; sets forth the circumstances and procedures governing the making of payroll deductions from the wages of those employed on such work; and delineates the methods of payment permissible on such work.

#### Section 3.2 Definitions.

As used in the regulations in this part:

(a) The terms "building" or "work" generally include construction activity as distinguished from manufacturing, furnishing of materials, or servicing and maintenance work. The terms include, without limitation, buildings, structures, and improvements of all @s, such as bridges, dams, plants, highways, parkways, streets, subways, tunnels, sewers, mains, powerlines, pumping stations, railways, airports, terminals, docks, piers, wharves, ways, lighthouses, buoys, jetties, breakwaters, levees, and canals; dredging, shoring, scaffolding, drilling, blasting, excavating, clearing, and landscaping. Unless conducted in connection with and at the site of such a building or work as is described in the foregoing sentence, the manufacture or furnishing of materials, articles, supplies, or equipment (whether or not a Federal or State agency acquires title to such materials,

#### *Copeland Act Regulations*

articles, supplies, or equipment during the course of the manufacture or furnishing, or owns the materials from which they are manufactured or furnished) is not a "building" or "work" within the meaning of the regulations in this part.

(b) The terms "construction," "prosecution," "completion," or "repair" mean all types of work done on a particular building or work at the site thereof, including, without limitation, altering, remodeling, painting and decorating, the transporting of materials and supplies to or from the building or work by the employees of the construction contractor or construction subcontractor, and the manufacturing or furnishing of materials, articles, supplies, or equipment on the site of the building or work, by persons employed at the site by the contractor or subcontractor.

(c) The terms "public building" or "public work" include building or work for whose construction, prosecution, completion, or repair, as defined above, a Federal agency is a contracting party, regardless of whether title thereof is in a Federal agency.

(d) The term "building or work financed in whole or in part by loans or grants from the United States" includes building or work for whose construction, prosecution, completion, or repair, as defined above, payment or part payment is made directly or indirectly from funds provided by loans or grants by a Federal agency. The term includes building or work for which the Federal assistance granted is in the form of loan guarantees or insurance.

(e) Every person paid by a contractor or subcontractor in any manner for his labor in the construction, prosecution, completion, or repair of a public building or public work or building or work financed in whole or in part by loans or grants from the United States is "employed" and receiving 44 wages," regardless of any contractual relationship alleged to exist between him and the real employer.

(f) The term "any affiliated person" includes a spouse, child, parent, or other close relative of the contractor or subcontractor; a partner or officer of the contractor or subcontractor; a corporation closely connected with the contractor or subcontractor as parent, subsidiary or otherwise, and an officer or agent of such corporation.

(g) The term "Federal agency" means the United States, the District of Columbia, and all executive departments, independent establishments, administrative agencies, and instrumentality's of the United States and of the District of Columbia, including corporations, all or substantially all of the stock of which is beneficially owned by the United States, by the District of Columbia, or any of the foregoing departments, establishments, agencies, and

(a) Each weekly statement required under §3.3 shall be delivered by the contractor or subcontractor, within seven days after the regular payment date of the payroll period, to a representative of a Federal or

instrumentality's.

(29 FR 97, Jan. 4, 1964, as amended at 33 FR 32575, Nov. 27, 1973)

### **Section 3.3 Weekly statement with respect to payment of wages.**

(a) As used in this section, the term "employee" shall not apply to persons in classifications higher than that of laborer or mechanic and those who are the immediate supervisors of such employees.

(b) Each contractor or subcontractor engaged in the construction, prosecution, completion, or repair of any public building or public work, or building or work financed in whole or in part by loans or grants from the United States, shall furnish each week a statement with respect to the wages paid each of its employees engaged on work covered by 29 CFR Parts 3 and 5 during the preceding weekly payroll period. This statement shall be executed by the contractor or subcontractor or by an authorized officer of employee of the contractor or subcontractor who supervises the payment of wages, and shall be on form @ 348, "Statement of Compliance," or on an identical form on the back of @ 347, "Payroll (For Contractors Optional Use)" or on any form with identical wording. Sample copies of @ 347 and @ 348 may be obtained from the Government contracting or sponsoring agency, and copies of these forms may be purchased at the Government Printing Office.

(c) The requirements of this section shall not apply to any contract of \$2,000 or less.

(d) Upon a written finding by the head of a Federal agency, the Secretary of Labor may provide reasonable limitations, variations, tolerances, and exemptions from the requirements of this section subject to such conditions as the Secretary of Labor may specify.

(29 F.R. 95, Jan. 4, 1964, as amended at 33 F.R. 10186, July 17, 1968)

### *Copeland Act Regulations*

### **Section 3.4 Submission of weekly statements and the preservation and inspection of weekly payroll records.**

State agency in charge at the site of the building or work, or if there is no representative of a Federal or State agency at the site of the building or work, the statement shall be mailed by the contractor or

subcontractor, within such time, to a Federal or State agency contracting for or financing the building or work. After such examination and check as may be made, such statement, or a copy thereof, shall be kept available, or shall be transmitted together with a report of any violation, in accordance with applicable procedures prescribed by the United States Department of Labor.

(b) Each contractor or subcontractor shall preserve his weekly payroll records for a period of three years from date of completion of the contract. The payroll records shall set out accurately and completely the name and address of each laborer and mechanic, his correct classification, rate of pay, daily and weekly number of hours worked, deductions made, and actual wages paid. Such payroll records shall be made available at all times for inspection by the contracting officer or his authorized representative, and by authorized representatives of the Department of Labor.

### **Section 3.5 Payroll deductions permissible without application to or approval of the Secretary of Labor.**

Deductions made under the circumstances or in the situations described in the paragraphs of this section may be made without application to and approval of the Secretary of Labor:

(a) Any deduction made in compliance with the requirements of Federal, State, or local law, such as Federal or State withholding income taxes and Federal social security taxes.

(b) Any deduction of sums previously paid to the employee as a bona fide prepayment of wages when such prepayment is made without discount or interest. A "bona fide prepayment of wages" is considered to have been made only when cash or its equivalent has been advanced to the person employed in such manner as to give him complete freedom of disposition of the advanced funds.

(c) Any deduction of amounts required by court process to be paid to another, unless, the deduction is in favor of the contractor, subcontractor or any affiliated person, or when collusion or collaboration exists.

(d) Any deduction constituting a contribution on behalf of the person employed to funds established by the employer or representatives of employees, or both, for the purpose of providing either from principal or income, or both, medical or hospital care, pensions, or annuities on retirement, death benefits, compensation for injuries, illness, accidents, sickness,

(k) Any deduction for the cost of safety equipment of nominal value purchased by the

or disability, or for insurance to provide any of the foregoing, or unemployment benefits, vacation pay, savings accounts, or similar payments for the benefit of employees, their families and dependents:

Provided, however, That the following standards are met: (1) The deduction is not otherwise prohibited by law; (2) it is either: (i) Voluntarily consented to by the employee in writing and in advance of the period in which the work is to be done and such consent is not a condition either for the obtaining of or for the continuation of employment, or (ii) provided for in a bona fide collective bargaining agreement between the contractor or subcontractor and representatives of its employees; (3) no profit or other benefit is otherwise obtained, directly or indirectly, by the contractor or subcontractor or any affiliated person in the form of commission, dividend, or otherwise; and (4) the deductions shall serve the convenience and interest of the employee. (e) Any deduction contributing toward the purchase of United States Defense Stamps and Bonds when voluntarily authorized by the employee.

(f) Any deduction requested by the employee to enable him to repay loans to or to purchase shares in credit unions organized and operated in accordance with Federal and State credit union statutes.

(g) Any deduction voluntarily authorized by the employee for the making of contributions to

#### *Copeland Act Regulations*

governmental or quasi-governmental agencies, such as the American Red Cross.

(h) Any deduction voluntarily authorized by the employee for the making of contributions to Community Chests, United Givers Funds, and similar charitable organizations.

(i) Any deductions to pay regular union initiation fees and membership dues, not including fines or special assessments: Provided, however, That a collective bargaining agreement between the contractor or subcontractor and representatives of its employees provides for such deductions and the deductions are not otherwise prohibited by law.

(j) Any deduction not more than for the "reasonable cost" of board, lodging, or other facilities meeting the requirements of section 3(m) of the Fair Labor Standards Act of 1938, as amended, and Part 531 of this title. When such a deduction is made the additional records required under §516.27(a) of this title shall be kept.

employee as his own prope@ for his personal protection in his work, such as safety shoes, safety

glasses, safety gloves, and hard hats, if such equipment is not required by law to be furnished by the employer, if such deduction is not violative of the Fair Labor Standards Act or prohibited by other law, if the cost on which the deduction is based does not exceed the actual cost to the employer where the equipment is purchased from him and does not include any direct or indirect monetary return to the employer where the equipment is purchased from a third person, and if the deduction is either (1) voluntarily consented to by the employee in writing and in advance of the period in which the work is to be done and such consent is not a condition either for the obtaining of employment or its continuance; or (2) provided for in a bona fide collective bargaining agreement between the contractor or subcontractor and representatives of its employees. (36 F.R. 9770, May 28, 1971.)

### **Section 3.6 Payroll deductions permissible with the approval of the Secretary of Labor.**

Any contractor or subcontractor may apply to the Secretary of Labor for permission to make any

deduction not permitted under §3.5. The Secretary may grant permission whenever he finds that:

(a) The contractor, subcontractor, or any affiliated person does not make a profit or benefit

directly or indirectly from the deduction either in the form of a commission, dividend, or otherwise;

(b) The deduction is not otherwise prohibited by law;

(c) The deduction is either (1) voluntarily consented to by the employee in writing and in advance of the period in which the work is to be done and such consent is not a condition either for the obtaining of employment or its continuance, or (2) provided for in a bona fide collective bargaining agreement between the contractor or subcontractor and representatives of its employees; and

(d) The deduction serves the convenience and interest of the employee.

### **Section 3.7 Applications for the approval of the Secretary of Labor.**

Any application for the making of payroll deductions under §3.6 shall comply with the requirements prescribed in the following paragraphs of this section:

(a) The application shall be in writing and shall be addressed to the Secretary of Labor.

(b) The application need not identify the

contract or contracts under which the work in question is to be performed. Permission will be given for deductions on all current and future contracts of the applicant for a period of 1 year. A renewal of permission to make such payroll deduction will be granted upon the submission of an application which makes reference to the original application, recites the date of the Secretary of Labor's approval of such deductions, states affirmatively that there is continued compliance with the standards set forth in the provisions of §3.6, and specifies any conditions which have changed in regard to the payroll deductions.

(36 F.R. 9770, May 29, 1971.)

(c) The application shall state affirmatively that there is compliance with the standards set forth in the provisions of §3.6. The affirmation shall be accompanied by a full statement of the facts indicating such compliance.

### *Copeland Act Regulations*

(d) The application shall include a description of the proposed deduction, the purpose to be served there by, and the classes of laborers or mechanics from whose wages the proposed deduction would be made.

(e) The application shall state the name and business of any third person to whom any funds obtained from the proposed deductions are to be transmitted and the affiliation of such person, if any, with the applicant. -

#### **Section 3.8 Action by the Secretary of Labor upon applications.**

The Secretary of Labor shall decide whether or not the requested deduction is permissible under provisions of §3.6; and shall notify the applicant in writing of his decision.

#### **Section 3.9 Prohibited payroll deductions.**

Deductions not elsewhere provided for by this part and which are not found to be permissible under §3.6 are prohibited.

#### **Section 3.10 Methods of payment of wages.**

The payment of wages shall be by cash, negotiable instruments payable on demand, or the additional forms of compensation for which deductions are permissible under this part. No other methods of payment shall be recognized on work subject to the Copeland Act.

#### **Section 3.11 Regulations part of contract.**

All contracts made with respect to the construction, prosecution, completion, or repair of any public building or public work or building or work financed in whole or in part by loans or grants from the United States covered by the regulations in this part shall expressly bind the contractor or subcontractor to comply with such of the regulations in this part as may be applicable. In this regard, see §5.5(a) of this subtitle.

STANDARD  
GENERAL CONDITIONS  
OF THE  
CONSTRUCTION CONTRACT

Prepared by

ENGINEERS JOINT CONTRACT DOCUMENTS COMMITTEE

and

Issued and Published Jointly By

PROFESSIONAL ENGINEERS IN PRIVATE PRACTICE  
*a practice division of the*  
NATIONAL SOCIETY OF PROFESSIONAL ENGINEERS

---

AMERICAN CONSULTING ENGINEERS COUNCIL

---

AMERICAN SOCIETY OF CIVIL ENGINEERS

This document has been approved and endorsed by

The Associated General Contractors of America

Construction Specifications Institute

Copyright ©1996

National Society of Professional Engineers  
1420 King Street, Alexandria, VA 22314

American Consulting Engineers Council  
1015 15th Street N.W., Washington, DC 20005

American Society of Civil Engineers  
345 East 47th Street, New York, NY 10017

TABLE OF CONTENTS

Page

ARTICLE 1 - DEFINITIONS AND TERMINOLOGY .....6  
    1.01 *Defined Terms* .....6  
    1.02 *Terminology*.....8

ARTICLE 2 - PRELIMINARY MATTERS .....9  
    2.01 *Delivery of Bonds*.....9  
    2.02 *Copies of Documents*.....9  
    2.03 *Commencement of Contract Times; Notice to Proceed* .....9  
    2.04 *Starting the Work* .....9  
    2.05 *Before Starting Construction* .....9  
    2.06 *Preconstruction Conference*.....10  
    2.07 *Initial Acceptance of Schedules*.....10

ARTICLE 3 - CONTRACT DOCUMENTS: INTENT, AMENDING, REUSE.....10  
    3.01 *Intent* .....10  
    3.02 *Reference Standards* .....10  
    3.03 *Reporting and Resolving Discrepancies*.....10  
    3.04 *Amending and Supplementing Contract Documents*.....11  
    3.05 *Reuse of Documents*.....11

ARTICLE 4 - AVAILABILITY OF LANDS; SUBSURFACE AND PHYSICAL CONDITIONS; REFERENCE  
POINTS .....11  
    4.01 *Availability of Lands*.....11  
    4.02 *Subsurface and Physical Conditions*.....12  
    4.03 *Differing Subsurface or Physical Conditions*.....12  
    4.04 *Underground Facilities*.....13  
    4.05 *Reference Points* .....13  
    4.06 *Hazardous Environmental Condition at Site*.....14

ARTICLE 5 - BONDS AND INSURANCE.....15  
    5.01 *Performance, Payment, and Other Bonds* .....15  
    5.02 *Licensed Sureties and Insurers* .....15  
    5.03 *Certificates of Insurance* .....15  
    5.04 *CONTRACTOR's Liability Insurance* .....15  
    5.05 *OWNER's Liability Insurance* .....16  
    5.06 *Property Insurance*.....16  
    5.07 *Waiver of Rights* .....17  
    5.08 *Receipt and Application of Insurance Proceeds* .....18  
    5.09 *Acceptance of Bonds and Insurance; Option to Replace*.....18  
    5.10 *Partial Utilization, Acknowledgment of Property Insurer* .....18

ARTICLE 6 - CONTRACTOR'S RESPONSIBILITIES .....18  
    6.01 *Supervision and Superintendence* .....18  
    6.02 *Labor; Working Hours*.....19  
    6.03 *Services, Materials, and Equipment* .....19  
    6.04 *Progress Schedule* .....19  
    6.05 *Substitutes and "Or-Equals"* .....19  
    6.06 *Concerning Subcontractors, Suppliers, and Others*.....21

6.07 Patent Fees and Royalties .....	21
6.08 Permits .....	22
6.09 Laws and Regulations .....	22
6.10 Taxes .....	22
6.11 Use of Site and Other Areas.....	22
6.12 Record Documents.....	22
6.13 Safety and Protection .....	23
6.14 Safety Representative.....	23
6.15 Hazard Communication Programs.....	23
6.16 Emergencies.....	23
6.17 Shop Drawings and Samples.....	24
6.18 Continuing the Work .....	25
6.19 CONTRACTOR's General Warranty and Guarantee .....	25
6.20 Indemnification.....	25
ARTICLE 7 - OTHER WORK .....	26
7.01 Related Work at Site .....	26
7.02 Coordination.....	26
ARTICLE 8 - OWNER'S RESPONSIBILITIES .....	27
8.01 Communications to Contractor.....	27
8.02 Replacement of ENGINEER.....	27
8.03 Furnish Data .....	27
8.04 Pay Promptly When Due.....	27
8.05 Lands and Easements; Reports and Tests .....	27
8.06 Insurance.....	27
8.07 Change Orders .....	27
8.08 Inspections, Tests, and Approvals .....	27
8.09 Limitations on OWNER's Responsibilities.....	27
8.10 Undisclosed Hazardous Environmental Condition.....	27
8.11 Evidence of Financial Arrangements .....	27
ARTICLE 9 - ENGINEER'S STATUS DURING CONSTRUCTION.....	27
9.01 OWNER'S Representative .....	27
9.02 Visits to Site .....	28
9.03 Project Representative.....	28
9.04 Clarifications and Interpretations.....	28
9.05 Authorized Variations in Work .....	28
9.06 Rejecting Defective Work .....	29
9.07 Shop Drawings, Change Orders and Payments.....	29
9.08 Determinations for Unit Price Work.....	28
9.09 Decisions on Requirements of Contract Documents and Acceptability of Work .....	28
9.10 Limitations on ENGINEER's Authority and Responsibilities .....	28
ARTICLE 10 - CHANGES IN THE WORK; CLAIMS.....	29
10.01 Authorized Changes in the Work.....	29
10.02 Unauthorized Changes in the Work.....	29
10.03 Execution of Change Orders .....	30
10.04 Notification to Surety .....	30
10.05 Claims and Disputes .....	30
ARTICLE 11 - COST OF THE WORK; CASH ALLOWANCES; UNIT PRICE WORK.....	30
11.01 Cost of the Work.....	30

11.02 Cash Allowances .....	32
11.03 Unit Price Work .....	33
ARTICLE 12 - CHANGE OF CONTRACT PRICE; CHANGE OF CONTRACT TIMES .....	33
12.01 Change of Contract Price .....	33
12.02 Change of Contract Times .....	34
12.03 Delays Beyond CONTRACTOR's Control.....	34
12.04 Delays Within CONTRACTOR's Control .....	34
12.05 Delays Beyond OWNER's and CONTRACTOR'S Control.....	34
12.06 Delay Damages .....	34
ARTICLE 13 - TESTS AND INSPECTIONS; CORRECTION, REMOVAL OR ACCEPTANCE OF DEFECTIVE WORK.....	34
13.01 Notice of Defects .....	34
13.02 Access to Work .....	34
13.03 Tests and Inspections.....	35
13.04 Uncovering Work.....	35
13.05 OWNER May Stop the Work .....	35
13.06 Correction or Removal of Defective Work .....	36
13.07 Correction Period .....	36
13.08 Acceptance of Defective Work .....	36
13.09 OWNER May Correct Defective Work.....	36
ARTICLE 14 - PAYMENTS TO CONTRACTOR AND COMPLETION .....	37
14.01 Schedule of Values .....	37
14.02 Progress Payments .....	37
14.03 CONTRACTOR's Warranty of Title .....	38
14.04 Substantial Completion .....	39
14.05 Partial Utilization.....	39
14.06 Final Inspection.....	39
14.07 Final Payment.....	40
14.08 Final Completion Delayed.....	40
14.09 Waiver of Claims.....	41
ARTICLE 15 - SUSPENSION OF WORK AND TERMINATION.....	41
15.01 OWNER May Suspend Work .....	41
15.02 OWNER May Terminate for Cause .....	41
15.03 OWNER May Terminate For Convenience .....	41
15.04 CONTRACTOR May Stop Work or Terminate.....	42
ARTICLE 16 - DISPUTE RESOLUTION .....	42
16.01 Methods and Procedures .....	42
ARTICLE 17 - MISCELLANEOUS.....	43
17.01 Giving Notice .....	43
17.02 Computation of Times.....	43
17.03 Cumulative Remedies.....	43
17.04 Survival of Obligations .....	43
17.05 Controlling Law .....	43

## GENERAL CONDITIONS

### ARTICLE 1 - DEFINITIONS AND TERMINOLOGY

---

#### 1.01 *Defined Terms*

A. Wherever used in the Contract Documents and printed with initial or all capital letters, the terms listed below will have the meanings indicated which are applicable to both the singular and plural thereof.

1. *Addenda*--Written or graphic instruments issued prior to the opening of Bids which clarify, correct, or change the Bidding Requirements or the Contract Documents.

2. *Agreement*--The written instrument which is evidence of the agreement between OWNER and CONTRACTOR covering the Work.

3. *Application for Payment*--The form acceptable to ENGINEER which is to be used by CONTRACTOR during the course of the Work in requesting progress or final payments and which is to be accompanied by such supporting documentation as is required by the Contract Documents.

4. *Asbestos*--Any material that contains more than one percent asbestos and is friable or is releasing asbestos fibers into the air above current action levels established by the United States Occupational Safety and Health Administration.

5. *Bid*--The offer or proposal of a bidder submitted on the prescribed form setting forth the prices for the Work to be performed.

6. *Bidding Documents*--The Bidding Requirements and the proposed Contract Documents (including all Addenda issued prior to receipt of Bids).

7. *Bidding Requirements*--The Advertisement or Invitation to Bid, Instructions to Bidders, Bid security form, if any, and the Bid form with any supplements.

8. *Bonds*--Performance and payment bonds and other instruments of security.

9. *Change Order*--A document recommended by ENGINEER which is signed by CONTRACTOR and OWNER and authorizes an addition, deletion, or revision in the Work or an adjustment in the Contract Price or the

Contract Times, issued on or after the Effective Date of the Agreement.

10. *Claim*--A demand or assertion by OWNER or CONTRACTOR seeking an adjustment of Contract Price or Contract Times, or both, or other relief with respect to the terms of the Contract. A demand for money or services by a third party is not a Claim.

11. *Contract*--The entire and integrated written agreement between the OWNER and CONTRACTOR concerning the Work. The Contract supersedes prior negotiations, representations, or agreements, whether written or oral.

12. *Contract Documents*--The Contract Documents establish the rights and obligations of the parties and include the Agreement, Addenda (which pertain to the Contract Documents), CONTRACTOR's Bid (including documentation accompanying the Bid and any post Bid documentation submitted prior to the Notice of Award) when attached as an exhibit to the Agreement, the Notice to Proceed, the Bonds, these General Conditions, the Supplementary Conditions, the Specifications and the Drawings as the same are more specifically identified in the Agreement, together with all Written Amendments, Change Orders, Work Change Directives, Field Orders, and ENGINEER's written interpretations and clarifications issued on or after the Effective Date of the Agreement. Approved Shop Drawings and the reports and drawings of subsurface and physical conditions are not Contract Documents. Only printed or hard copies of the items listed in this paragraph are Contract Documents. Files in electronic media format of text, data, graphics, and the like that may be furnished by OWNER to CONTRACTOR are not Contract Documents.

13. *Contract Price*--The moneys payable by OWNER to CONTRACTOR for completion of the Work in accordance with the Contract Documents as stated in the Agreement (subject to the provisions of paragraph 11.03 in the case of Unit Price Work).

14. *Contract Times*--The number of days or the dates stated in the Agreement to: (i) achieve Substantial Completion; and (ii) complete the Work so that it is ready for final payment as evidenced by ENGINEER's written recommendation of final payment.

15. *CONTRACTOR*--The individual or entity with whom OWNER has entered into the Agreement.

16. *Cost of the Work*--See paragraph 11.01.A for definition.

17. *Drawings*--That part of the Contract Documents prepared or approved by ENGINEER which graphically shows the scope, extent, and character of the Work to be performed by CONTRACTOR. Shop Drawings and other CONTRACTOR submittals are not Drawings as so defined.

18. *Effective Date of the Agreement*--The date indicated in the Agreement on which it becomes effective, but if no such date is indicated, it means the date on which the Agreement is signed and delivered by the last of the two parties to sign and deliver.

19. *ENGINEER*--The individual or entity named as such in the Agreement.

20. *ENGINEER's Consultant*--An individual or entity having a contract with ENGINEER to furnish services as ENGINEER's independent professional associate or consultant with respect to the Project and who is identified as such in the Supplementary Conditions.

21. *Field Order*--A written order issued by ENGINEER which requires minor changes in the Work but which does not involve a change in the Contract Price or the Contract Times.

22. *General Requirements*--Sections of Division 1 of the Specifications. The General Requirements pertain to all sections of the Specifications.

23. *Hazardous Environmental Condition*--The presence at the Site of Asbestos, PCBs, Petroleum, Hazardous Waste, or Radioactive Material in such quantities or circumstances that may present a substantial danger to persons or property exposed thereto in connection with the Work.

24. *Hazardous Waste*--The term Hazardous Waste shall have the meaning provided in Section 1004 of the Solid Waste Disposal Act (42 USC Section 6903) as amended from time to time.

25. *Laws and Regulations; Laws or Regulations*--Any and all applicable laws, rules, regulations, ordinances, codes, and orders of any and all governmental bodies, agencies, authorities, and courts having jurisdiction.

26. *Liens*--Charges, security interests, or encumbrances upon Project funds, real property, or personal property.

27. *Milestone*--A principal event specified in the Contract Documents relating to an intermediate completion date or time prior to Substantial Completion of all the Work.

28. *Notice of Award*--The written notice by OWNER to the apparent successful bidder stating that upon timely compliance by the apparent successful bidder with the conditions precedent listed therein, OWNER will sign and deliver the Agreement.

29. *Notice to Proceed*--A written notice given by OWNER to CONTRACTOR fixing the date on which the Contract Times will commence to run and on which CONTRACTOR shall start to perform the Work under the Contract Documents.

30. *OWNER*--The individual, entity, public body, or authority with whom CONTRACTOR has entered into the Agreement and for whom the Work is to be performed.

31. *Partial Utilization*--Use by OWNER of a substantially completed part of the Work for the purpose for which it is intended (or a related purpose) prior to Substantial Completion of all the Work.

32. *PCBs*--Polychlorinated biphenyls.

33. *Petroleum*--Petroleum, including crude oil or any fraction thereof which is liquid at standard conditions of temperature and pressure (60 degrees Fahrenheit and 14.7 pounds per square inch absolute), such as oil, petroleum, fuel oil, oil sludge, oil refuse, gasoline, kerosene, and oil mixed with other non-Hazardous Waste and crude oils.

34. *Project*--The total construction of which the Work to be performed under the Contract Documents may be the whole, or a part as may be indicated elsewhere in the Contract Documents.

35. *Project Manual*--The bound documentary information prepared for bidding and constructing the Work. A listing of the contents of the Project Manual, which may be bound in one or more volumes, is contained in the table(s) of contents.

36. *Radioactive Material*--Source, special nuclear, or byproduct material as defined by the Atomic Energy Act of 1954 (42 USC Section 2011 et seq.) as amended from time to time.

37. *Resident Project Representative*--The authorized representative of ENGINEER who may be assigned to the Site or any part thereof.

38. *Samples*--Physical examples of materials, equipment, or workmanship that are representative of some portion of the Work and which establish the standards by which such portion of the Work will be judged.

39. *Shop Drawings*--All drawings, diagrams, illustrations, schedules, and other data or information which are specifically prepared or assembled by or for CONTRACTOR and submitted by CONTRACTOR to illustrate some portion of the Work.

40. *Site*--Lands or areas indicated in the Contract Documents as being furnished by OWNER upon which the Work is to be performed, including rights-of-way and easements for access thereto, and such other lands furnished by OWNER which are designated for the use of CONTRACTOR.

41. *Specifications*--That part of the Contract Documents consisting of written technical descriptions of materials, equipment, systems, standards, and workmanship as applied to the Work and certain administrative details applicable thereto.

42. *Subcontractor*--An individual or entity having a direct contract with CONTRACTOR or with any other Subcontractor for the performance of a part of the Work at the Site.

43. *Substantial Completion*--The time at which the Work (or a specified part thereof) has progressed to the point where, in the opinion of ENGINEER, the Work (or a specified part thereof) is sufficiently complete, in accordance with the Contract Documents, so that the Work (or a specified part thereof) can be utilized for the purposes for which it is intended. The terms "substantially complete" and "substantially completed" as applied to all or part of the Work refer to Substantial Completion thereof.

44. *Supplementary Conditions*--That part of the Contract Documents which amends or supplements these General Conditions.

45. *Supplier*--A manufacturer, fabricator, supplier, distributor, materialman, or vendor having a direct contract with CONTRACTOR or with any Subcontractor to furnish materials or equipment to be incorporated in the Work by CONTRACTOR or any Subcontractor.

46. *Underground Facilities*--All underground pipelines, conduits, ducts, cables, wires, manholes, vaults, tanks, tunnels, or other such facilities or attachments, and any encasements containing such facilities, including those that convey electricity, gases, steam, liquid petroleum products, telephone or other communications, cable television, water, wastewater, storm water, other liquids or chemicals, or traffic or other control systems.

47. *Unit Price Work*--Work to be paid for on the basis of unit prices.

48. *Work*--The entire completed construction or the various separately identifiable parts thereof required to be provided under the Contract Documents. Work includes and is the result of performing or providing all labor, services, and documentation necessary to produce such construction, and furnishing, installing, and incorporating all materials and equipment into such construction, all as required by the Contract Documents.

49. *Work Change Directive*--A written statement to CONTRACTOR issued on or after the Effective Date of the Agreement and signed by OWNER and recommended by ENGINEER ordering an addition, deletion, or revision in the Work, or responding to differing or unforeseen subsurface or physical conditions under which the Work is to be performed or to emergencies. A Work Change Directive will not change the Contract Price or the Contract Times but is evidence that the parties expect that the change ordered or documented by a Work Change Directive will be incorporated in a subsequently issued Change Order following negotiations by the parties as to its effect, if any, on the Contract Price or Contract Times.

50. *Written Amendment*--A written statement modifying the Contract Documents, signed by OWNER and CONTRACTOR on or after the Effective Date of the Agreement and normally dealing with the nonengineering or nontechnical rather than strictly construction-related aspects of the Contract Documents.

1.02 *Terminology*

A. *Intent of Certain Terms or Adjectives*

1. Whenever in the Contract Documents the terms "as allowed," "as approved," or terms of like effect or import are used, or the adjectives "reasonable," "suitable," "acceptable," "proper," "satisfactory," or adjectives of like effect or import are used to describe an action or determination of ENGINEER as to the Work, it is intended that such action or determination will be solely to evaluate, in general, the completed Work for compliance with the requirements of and information in the Contract Documents and conformance with the design concept of the completed Project as a functioning whole as shown or indicated in the Contract Documents (unless there is a specific statement indicating otherwise). The use of any such term or adjective shall not be effective to assign to ENGINEER any duty or authority to supervise or direct the performance of the Work or any duty or authority to undertake responsibility contrary to the provisions of paragraph 9.10 or any other provision of the Contract Documents.

B. *Day*

1. The word "day" shall constitute a calendar day of 24 hours measured from midnight to the next midnight.

C. *Defective*

1. The word "defective," when modifying the word "Work," refers to Work that is unsatisfactory, faulty, or deficient in that it does not conform to the Contract Documents or does not meet the requirements of any inspection, reference standard, test, or approval referred to in the Contract Documents, or has been damaged prior to ENGINEER's recommendation of final payment (unless responsibility for the protection thereof has been assumed by OWNER at Substantial Completion in accordance with paragraph 14.04 or 14.05).

D. *Furnish, Install, Perform, Provide*

1. The word "furnish," when used in connection with services, materials, or equipment, shall mean to supply and deliver said services, materials, or equipment to the Site (or some other

specified location) ready for use or installation and in usable or operable condition.

2. The word "install," when used in connection with services, materials, or equipment, shall mean to put into use or place in final position said services, materials, or equipment complete and ready for intended use.

3. The words "perform" or "provide," when used in connection with services, materials, or equipment, shall mean to furnish and install said services, materials, or equipment complete and ready for intended use.

4. When "furnish," "install," "perform," or "provide" is not used in connection with services, materials, or equipment in a context clearly requiring an obligation of CONTRACTOR, "provide" is implied.

E. Unless stated otherwise in the Contract Documents, words or phrases which have a well-known technical or construction industry or trade meaning are used in the Contract Documents in accordance with such recognized meaning.

ARTICLE 2 - PRELIMINARY MATTERS

---

2.01 *Delivery of Bonds*

A. When CONTRACTOR delivers the executed Agreements to OWNER, CONTRACTOR shall also deliver to OWNER such Bonds as CONTRACTOR may be required to furnish.

2.02\* *Copies of Documents*

A. OWNER shall furnish to CONTRACTOR up to ten copies of the Contract Documents. Additional copies will be furnished upon request at the cost of reproduction.

2.03 *Commencement of Contract Times; Notice to Proceed*

A. The Contract Times will commence to run on the thirtieth day after the Effective Date of the Agreement or, if a Notice to Proceed is given, on the day indicated in the Notice to Proceed. A Notice to Proceed may be given at any time within 30 days after the Effective Date of the Agreement. In no event will the Contract Times com-

mence to run later than the sixtieth day after the day of Bid opening or the thirtieth day after the Effective Date of the Agreement, whichever date is earlier.

#### 2.04 *Starting the Work*

A. CONTRACTOR shall start to perform the Work on the date when the Contract Times commence to run. No Work shall be done at the Site prior to the date on which the Contract Times commence to run.

\*See Supplementary Conditions

#### 2.05\* *Before Starting Construction*

A. *CONTRACTOR's Review of Contract Documents:* Before undertaking each part of the Work, CONTRACTOR shall carefully study and compare the Contract Documents and check and verify pertinent figures therein and all applicable field measurements. CONTRACTOR shall promptly report in writing to ENGINEER any conflict, error, ambiguity, or discrepancy which CONTRACTOR may discover and shall obtain a written interpretation or clarification from ENGINEER before proceeding with any Work affected thereby; however, CONTRACTOR shall not be liable to OWNER or ENGINEER for failure to report any conflict, error, ambiguity, or discrepancy in the Contract Documents unless CONTRACTOR knew or reasonably should have known thereof.

B. *Preliminary Schedules:* Within ten days after the Effective Date of the Agreement (unless otherwise specified in the General Requirements), CONTRACTOR shall submit to ENGINEER for its timely review:

1. a preliminary progress schedule indicating the times (numbers of days or dates) for starting and completing the various stages of the Work, including any Milestones specified in the Contract Documents;
2. a preliminary schedule of Shop Drawing and Sample submittals which will list each required submittal and the times for submitting, reviewing, and processing such submittal; and
3. a preliminary schedule of values for all of the Work which includes quantities and prices of items which when added together equal the Contract Price and subdivides the Work into

component parts in sufficient detail to serve as the basis for progress payments during performance of the Work. Such prices will include an appropriate amount of overhead and profit applicable to each item of Work.

\* C. *Evidence of Insurance:* Before any Work at the Site is started, CONTRACTOR and OWNER shall each deliver to the other, with copies to each additional insured identified in the Supplementary Conditions, certificates of insurance (and other evidence of insurance which either of them or any additional insured may reasonably request) which CONTRACTOR and OWNER respectively are required to purchase and maintain in accordance with Article 5.

#### 2.06 *Preconstruction Conference*

A. Within 20 days after the Contract Times start to run, but before any Work at the Site is started, a conference attended by CONTRACTOR, ENGINEER, and others as appropriate will be held to establish a working understanding among the parties as to the Work and to discuss the schedules referred to in paragraph 2.05.B, procedures for handling Shop Drawings and other submittals, processing Applications for Payment, and maintaining required records.

#### 2.07 *Initial Acceptance of Schedules*

A. Unless otherwise provided in the Contract Documents, at least ten days before submission of the first Application for Payment a conference attended by CONTRACTOR, ENGINEER, and others as appropriate will be held to review for acceptability to ENGINEER as provided below the schedules submitted in accordance with paragraph 2.05.B. CONTRACTOR shall have an additional ten days to make corrections and adjustments and to complete and resubmit the schedules. No progress payment shall be made to CONTRACTOR until acceptable schedules are submitted to ENGINEER.

1. The progress schedule will be acceptable to ENGINEER if it provides an orderly progression of the Work to completion within any specified Milestones and the Contract Times. Such acceptance will not impose on ENGINEER responsibility for the progress schedule, for sequencing, scheduling, or progress of the Work nor interfere with or relieve CONTRACTOR from CONTRACTOR's full responsibility therefor.

2. CONTRACTOR's schedule of Shop Drawing and Sample submittals will be acceptable to ENGINEER if it provides a workable arrangement for reviewing and processing the required submittals.

3. CONTRACTOR's schedule of values will be acceptable to ENGINEER as to form and substance if it provides a reasonable allocation of the Contract Price to component parts of the Work.

\*See Supplementary Conditions

### ARTICLE 3 - CONTRACT DOCUMENTS: INTENT, AMENDING, REUSE

#### 3.01\* *Intent*

A. The Contract Documents are complementary; what is called for by one is as binding as if called for by all.

B. It is the intent of the Contract Documents to describe a functionally complete Project (or part thereof) to be constructed in accordance with the Contract Documents. Any labor, documentation, services, materials, or equipment that may reasonably be inferred from the Contract Documents or from prevailing custom or trade usage as being required to produce the intended result will be provided whether or not specifically called for at no additional cost to OWNER.

C. Clarifications and interpretations of the Contract Documents shall be issued by ENGINEER as provided in Article 9.

#### 3.02 *Reference Standards*

##### A. *Standards, Specifications, Codes, Laws, and Regulations*

1. Reference to standards, specifications, manuals, or codes of any technical society, organization, or association, or to Laws or Regulations, whether such reference be specific or by implication, shall mean the standard, specification, manual, code, or Laws or Regulations in effect at the time of opening of Bids (or on the Effective Date of the Agreement if there were no Bids), except as may be otherwise specifically stated in the Contract Documents.

2. No provision of any such standard, specification, manual or code, or any instruction of a Supplier shall be effective to change the duties or responsibilities of OWNER, CONTRACTOR, or ENGINEER, or any of their subcontractors, consultants, agents, or employees from those set forth in the Contract Documents, nor shall any such provision or instruction be effective to assign to OWNER, ENGINEER, or any of ENGINEER's Consultants, agents, or employees any duty or authority to supervise or direct the performance of the Work or any duty or authority to undertake responsibility inconsistent with the provisions of the Contract Documents.

#### 3.03 *Reporting and Resolving Discrepancies*

##### A. *Reporting Discrepancies*

1. If, during the performance of the Work, CONTRACTOR discovers any conflict, error, ambiguity, or discrepancy within the Contract Documents or between the Contract Documents and any provision of any Law or Regulation applicable to the performance of the Work or of any standard, specification, manual or code, or of any instruction of any Supplier, CONTRACTOR shall report it to ENGINEER in writing at once. CONTRACTOR shall not proceed with the Work affected thereby (except in an emergency as required by paragraph 6.16.A) until an amendment or supplement to the Contract Documents has been issued by one of the methods indicated in paragraph 3.04; provided, however, that CONTRACTOR shall not be liable to OWNER or ENGINEER for failure to report any such conflict, error, ambiguity, or discrepancy unless CONTRACTOR knew or reasonably should have known thereof.

##### B. *Resolving Discrepancies*

1. Except as may be otherwise specifically stated in the Contract Documents, the provisions of the Contract Documents shall take precedence in resolving any conflict, error, ambiguity, or discrepancy between the provisions of the Contract Documents and:

a. the provisions of any standard, specification, manual, code, or instruction (whether or not specifically incorporated by reference in the Contract Documents); or

b. the provisions of any Laws or Regulations applicable to the performance of the Work (unless such an interpretation of the provisions of the Contract Documents would result in violation of such Law or Regulation).

### 3.04 *Amending and Supplementing Contract Documents*

A. The Contract Documents may be amended to provide for additions, deletions, and revisions in the Work or to modify the terms and conditions thereof in one or

\*See Supplementary Conditions

B. The requirements of the Contract Documents may be supplemented, and minor variations and deviations in the Work may be authorized, by one or more of the following ways: (i) a Field Order; (ii) ENGINEER's approval of a Shop Drawing or Sample; or (iii) ENGINEER's written interpretation or clarification.

### 3.05 *Reuse of Documents*

A. CONTRACTOR and any Subcontractor or Supplier or other individual or entity performing or furnishing any of the Work under a direct or indirect contract with OWNER: (i) shall not have or acquire any title to or ownership rights in any of the Drawings, Specifications, or other documents (or copies of any thereof) prepared by or bearing the seal of ENGINEER or ENGINEER's Consultant, including electronic media editions; and (ii) shall not reuse any of such Drawings, Specifications, other documents, or copies thereof on extensions of the Project or any other project without written consent of OWNER and ENGINEER and specific written verification or adaption by ENGINEER. This prohibition will survive final payment, completion, and acceptance of the Work, or termination or completion of the Contract. Nothing herein shall preclude CONTRACTOR from retaining copies of the Contract Documents for record purposes.

## ARTICLE 4 - AVAILABILITY OF LANDS; SUBSURFACE AND PHYSICAL CONDITIONS; REFERENCE POINTS

### 4.01 *Availability of Lands*

A. OWNER shall furnish the Site. OWNER shall notify CONTRACTOR of any encumbrances or

restrictions not of general application but specifically related to use of the Site with which CONTRACTOR must comply in performing the Work. OWNER will obtain in a timely manner and pay for easements for permanent structures or permanent changes in existing facilities. If CONTRACTOR and OWNER are unable to agree on entitlement to or on the amount or extent, if any, of any adjustment in the Contract Price or Contract Times, or both, as a result of any delay in OWNER's furnishing the Site, CONTRACTOR may make a Claim therefor as provided in paragraph 10.05.

B. Upon reasonable written request, OWNER shall furnish CONTRACTOR with a current statement of record legal title and legal description of the lands upon which the Work is to be performed and OWNER's interest therein as necessary for giving notice of or filing a mechanic's or construction lien against such lands in accordance with applicable Laws and Regulations.

C. CONTRACTOR shall provide for all additional lands and access thereto that may be required for temporary construction facilities or storage of materials and equipment.

### 4.02\* *Subsurface and Physical Conditions*

A.\* *Reports and Drawings:* The Supplementary Conditions identify:

1. those reports of explorations and tests of subsurface conditions at or contiguous to the Site that ENGINEER has used in preparing the Contract Documents; and

2. those drawings of physical conditions in or relating to existing surface or subsurface structures at or contiguous to the Site (except Underground Facilities) that ENGINEER has used in preparing the Contract Documents.

B. *Limited Reliance by CONTRACTOR on Technical Data Authorized:* CONTRACTOR may rely upon the general accuracy of the "technical data" contained in such reports and drawings, but such reports and drawings are not Contract Documents. Such "technical data" is identified in the Supplementary Conditions. Except for such reliance on such "technical data," CONTRACTOR may not rely upon or make any Claim against OWNER, ENGINEER, or any of ENGINEER's Consultants with respect to:

1. the completeness of such reports and drawings for CONTRACTOR's purposes, includ-

ing, but not limited to, any aspects of the means, methods, techniques, sequences, and procedures of construction to be employed by CONTRACTOR, and safety precautions and programs incident thereto; or

2. other data, interpretations, opinions, and information contained in such reports or shown or indicated in such drawings; or

3. any CONTRACTOR interpretation of or conclusion drawn from any "technical data" or any such other data, interpretations, opinions, or information.

\*See Supplementary Conditions

#### 4.03 *Differing Subsurface or Physical Conditions*

A. *Notice:* If CONTRACTOR believes that any subsurface or physical condition at or contiguous to the Site that is uncovered or revealed either:

1. is of such a nature as to establish that any "technical data" on which CONTRACTOR is entitled to rely as provided in paragraph 4.02 is materially inaccurate; or

2. is of such a nature as to require a change in the Contract Documents; or

3. differs materially from that shown or indicated in the Contract Documents; or

4. is of an unusual nature, and differs materially from conditions ordinarily encountered and generally recognized as inherent in work of the character provided for in the Contract Documents; then CONTRACTOR shall, promptly after becoming aware thereof and before further disturbing the subsurface or physical conditions or performing any Work in connection therewith (except in an emergency as required by paragraph 6.16.A), notify OWNER and ENGINEER in writing about such condition. CONTRACTOR shall not further disturb such condition or perform any Work in connection therewith (except as aforesaid) until receipt of written order to do so.

B. *ENGINEER's Review:* After receipt of written notice as required by paragraph 4.03.A, ENGINEER will promptly review the pertinent condition, determine the

necessity of OWNER's obtaining additional exploration or tests with respect thereto, and advise OWNER in writing (with a copy to CONTRACTOR) of ENGINEER's findings and conclusions.

#### C. *Possible Price and Times Adjustments*

1. The Contract Price or the Contract Times, or both, will be equitably adjusted to the extent that the existence of such differing subsurface or physical condition causes an increase or decrease in CONTRACTOR's cost of, or time required for, performance of the Work; subject, however, to the following:

a. such condition must meet any one or more of the categories described in paragraph 4.03.A; and

b. with respect to Work that is paid for on a Unit Price Basis, any adjustment in Contract Price will be subject to the provisions of paragraphs 9.08 and 11.03.

2. CONTRACTOR shall not be entitled to any adjustment in the Contract Price or Contract Times if:

a. CONTRACTOR knew of the existence of such conditions at the time CONTRACTOR made a final commitment to OWNER in respect of Contract Price and Contract Times by the submission of a Bid or becoming bound under a negotiated contract; or

b. the existence of such condition could reasonably have been discovered or revealed as a result of any examination, investigation, exploration, test, or study of the Site and contiguous areas required by the Bidding Requirements or Contract Documents to be conducted by or for CONTRACTOR prior to CONTRACTOR's making such final commitment; or

c. CONTRACTOR failed to give the written notice within the time and as required by paragraph 4.03.A.

3. If OWNER and CONTRACTOR are unable to agree on entitlement to or on the amount or extent, if any, of any adjustment in the Contract Price or Contract Times, or both, a Claim may be

made therefor as provided in paragraph 10.05. However, OWNER, ENGINEER, and ENGINEER's Consultants shall not be liable to CONTRACTOR for any claims, costs, losses, or damages (including but not limited to all fees and charges of engineers, architects, attorneys, and other professionals and all court or arbitration or other dispute resolution costs) sustained by CONTRACTOR on or in connection with any other project or anticipated project.

#### 4.04 *Underground Facilities*

A. *Shown or Indicated:* The information and data shown or indicated in the Contract Documents with respect to existing Underground Facilities at or contiguous to the Site is based on information and data furnished to OWNER or ENGINEER by the owners of such Underground Facilities, including OWNER, or by others. Unless it is otherwise expressly provided in the Supplementary Conditions:

1. OWNER and ENGINEER shall not be responsible for the accuracy or completeness of any such information or data; and

2. the cost of all of the following will be included in the Contract Price, and CONTRACTOR shall have full responsibility for:

a. reviewing and checking all such information and data,

b. locating all Underground Facilities shown or indicated in the Contract Documents,

c. coordination of the Work with the owners of such Underground Facilities, including OWNER, during construction, and

d. the safety and protection of all such Underground Facilities and repairing any damage thereto resulting from the Work.

#### B. *Not Shown or Indicated*

1. If an Underground Facility is uncovered or revealed at or contiguous to the Site which was not shown or indicated, or not shown or indicated with reasonable accuracy in the Contract Documents, CONTRACTOR shall, promptly after becoming aware thereof and before further disturbing conditions affected thereby or

performing any Work in connection therewith (except in an emergency as required by paragraph 6.16.A), identify the owner of such Underground Facility and give written notice to that owner and to OWNER and ENGINEER. ENGINEER will promptly review the Underground Facility and determine the extent, if any, to which a change is required in the Contract Documents to reflect and document the consequences of the existence or location of the Underground Facility. During such time, CONTRACTOR shall be responsible for the safety and protection of such Underground Facility.

2. If ENGINEER concludes that a change in the Contract Documents is required, a Work Change Directive or a Change Order will be issued to reflect and document such consequences. An equitable adjustment shall be made in the Contract Price of Contract Times, or both, to the extent that they are attributable to the existence or location of any Underground Facility that was not shown or indicated or not shown or indicated with reasonable accuracy in the Contract Documents and that CONTRACTOR did not know of and could not reasonably have been expected to be aware of or to have anticipated. If OWNER and CONTRACTOR are unable to agree on entitlement to or on the amount or extent, if any, of any such adjustment in Contract Price or Contract Times, OWNER or CONTRACTOR may make a Claim therefor as provided in paragraph 10.05.

#### 4.05\* *Reference Points*

A. OWNER shall provide engineering surveys to establish reference points for construction which in ENGINEER's judgment are necessary to enable CONTRACTOR to proceed with the Work. CONTRACTOR shall be responsible for laying out the Work, shall protect and preserve the established reference points and property monuments, and shall make no changes or relocations without the prior written approval of OWNER.

CONTRACTOR shall report to ENGINEER whenever any reference point or property monument is lost or destroyed or requires relocation because of necessary changes in grades or locations, and shall be responsible for the accurate replacement or relocation of such reference points or property monuments by professionally qualified personnel.

#### 4.06 *Hazardous Environmental Condition at Site*

A. *Reports and Drawings*: Reference is made to the Supplementary Conditions for the identification of those reports and drawings relating to a Hazardous Environmental Condition identified at the Site, if any, that have been utilized by the ENGINEER in the preparation of the Contract Documents.

B. *Limited Reliance by CONTRACTOR on Technical Data Authorized*: CONTRACTOR may rely upon the general accuracy of the "technical data" contained in such reports and drawings, but such reports and drawings are not Contract Documents. Such "technical data" is identified in the Supplementary Conditions. Except for such reliance on such "technical data," CONTRACTOR may not rely upon or make any Claim against OWNER, ENGINEER or any of ENGINEER's Consultants with respect to:

1. the completeness of such reports and drawings for CONTRACTOR's purposes, including, but not limited to, any aspects of the means, methods, techniques, sequences and procedures of construction to be employed by CONTRACTOR and safety precautions and programs incident thereto; or

\*See Supplementary Conditions

2. other data, interpretations, opinions and information contained in such reports or shown or indicated in such drawings; or

3. any CONTRACTOR interpretation of or conclusion drawn from any "technical data" or any such other data, interpretations, opinions or information.

C. CONTRACTOR shall not be responsible for any Hazardous Environmental Condition uncovered or revealed at the Site which was not shown or indicated in Drawings or Specifications or identified in the Contract Documents to be within the scope of the Work. CONTRACTOR shall be responsible for a Hazardous Environmental Condition created with any materials brought to the Site by CONTRACTOR, Subcontractors, Suppliers, or anyone else for whom CONTRACTOR is responsible.

D. If CONTRACTOR encounters a Hazardous Environmental Condition or if CONTRACTOR or anyone for whom CONTRACTOR is responsible creates a Hazardous Environmental Condition, CONTRACTOR shall immediately: (i) secure or otherwise isolate such condition;

(ii) stop all Work in connection with such condition and in any area affected thereby (except in an emergency as required by paragraph 6.16); and (iii) notify OWNER and ENGINEER (and promptly thereafter confirm such notice in writing). OWNER shall promptly consult with ENGINEER concerning the necessity for OWNER to retain a qualified expert to evaluate such condition or take corrective action, if any.

E. CONTRACTOR shall not be required to resume Work in connection with such condition or in any affected area until after OWNER has obtained any required permits related thereto and delivered to CONTRACTOR written notice: (i) specifying that such condition and any affected area is or has been rendered safe for the resumption of Work; or (ii) specifying any special conditions under which such Work may be resumed safely. If OWNER and CONTRACTOR cannot agree as to entitlement to or on the amount or extent, if any, of any adjustment in Contract Price or Contract Times, or both, as a result of such Work stoppage or such special conditions under which Work is agreed to be resumed by CONTRACTOR, either party may make a Claim therefor as provided in paragraph 10.05.

F. If after receipt of such written notice CONTRACTOR does not agree to resume such Work based on a reasonable belief it is unsafe, or does not agree to resume such Work under such special conditions, then OWNER may order the portion of the Work that is in the area affected by such condition to be deleted from the Work. If OWNER and CONTRACTOR cannot agree as to entitlement to or on the amount or extent, if any, of an adjustment in Contract Price or Contract Times as a result of deleting such portion of the Work, then either party may make a Claim therefor as provided in paragraph 10.05. OWNER may have such deleted portion of the Work performed by OWNER's own forces or others in accordance with Article 7.

G. To the fullest extent permitted by Laws and Regulations, OWNER shall indemnify and hold harmless CONTRACTOR, Subcontractors, ENGINEER, ENGINEER's Consultants and the officers, directors, partners, employees, agents, other consultants, and subcontractors of each and any of them from and against all claims, costs, losses, and damages (including but not limited to all fees and charges of engineers, architects, attorneys, and other professionals and all court or arbitration or other dispute resolution costs) arising out of or relating to a Hazardous Environmental Condition, provided that such Hazardous Environmental Condition: (i) was not shown or indicated in the Drawings or

Specifications or identified in the Contract Documents to be included within the scope of the Work, and (ii) was not created by CONTRACTOR or by anyone for whom CONTRACTOR is responsible. Nothing in this paragraph 4.06.E shall obligate OWNER to indemnify any individual or entity from and against the consequences of that individual's or entity's own negligence.

H. To the fullest extent permitted by Laws and Regulations, CONTRACTOR shall indemnify and hold harmless OWNER, ENGINEER, ENGINEER's Consultants, and the officers, directors, partners, employees, agents, other consultants, and subcontractors of each and any of them from and against all claims, costs, losses, and damages (including but not limited to all fees and charges of engineers, architects, attorneys, and other professionals and all court or arbitration or other dispute resolution costs) arising out of or relating to a Hazardous Environmental Condition created by CONTRACTOR or by anyone for whom CONTRACTOR is responsible. Nothing in this paragraph 4.06.F shall obligate CONTRACTOR to indemnify any individual or entity from and against the consequences of that individual's or entity's own negligence.

I. The provisions of paragraphs 4.02, 4.03, and 4.04 are not intended to apply to a Hazardous Environmental Condition uncovered or revealed at the Site.

\*See Supplementary Conditions

## ARTICLE 5 - BONDS AND INSURANCE

### 5.01\* *Performance, Payment, and Other Bonds*

A. CONTRACTOR shall furnish performance and payment Bonds, each in an amount at least equal to the Contract Price as security for the faithful performance and payment of all CONTRACTOR's obligations under the Contract Documents. These Bonds shall remain in effect at least until one year after the date when final payment becomes due, except as provided otherwise by Laws or Regulations or by the Contract Documents. CONTRACTOR shall also furnish such other Bonds as are required by the Contract Documents.

B.\* All Bonds shall be in the form prescribed by the Contract Documents except as provided otherwise by Laws or Regulations, and shall be executed by such sureties as are named in the current list of "Companies Holding Certificates of Authority as Acceptable Sureties on Federal Bonds and as Acceptable Reinsuring Compa-

nies" as published in Circular 570 (amended) by the Financial Management Service, Surety Bond Branch, U.S. Department of the Treasury. All Bonds signed by an agent must be accompanied by a certified copy of such agent's authority to act.

C. If the surety on any Bond furnished by CONTRACTOR is declared bankrupt or becomes insolvent or its right to do business is terminated in any state where any part of the Project is located or it ceases to meet the requirements of paragraph 5.01.B, CONTRACTOR shall within 20 days thereafter substitute another Bond and surety, both of which shall comply with the requirements of paragraphs 5.01.B and 5.02.

### 5.02 *Licensed Sureties and Insurers*

A. All Bonds and insurance required by the Contract Documents to be purchased and maintained by OWNER or CONTRACTOR shall be obtained from surety or insurance companies that are duly licensed or authorized in the jurisdiction in which the Project is located to issue Bonds or insurance policies for the limits and coverages so required. Such surety and insurance companies shall also meet such additional requirements and qualifications as may be provided in the Supplementary Conditions.

### 5.03 *Certificates of Insurance*

A. CONTRACTOR shall deliver to OWNER, with copies to each additional insured identified in the Supplementary Conditions, certificates of insurance (and other evidence of insurance requested by OWNER or any other additional insured) which CONTRACTOR is required to purchase and maintain. OWNER shall deliver to CONTRACTOR, with copies to each additional insured identified in the Supplementary Conditions, certificates of insurance (and other evidence of insurance requested by CONTRACTOR or any other additional insured) which OWNER is required to purchase and maintain.

### 5.04\* *CONTRACTOR's Liability Insurance*

A. CONTRACTOR shall purchase and maintain such liability and other insurance as is appropriate for the Work being performed and as will provide protection from claims set forth below which may arise out of or result from CONTRACTOR's performance of the Work and CONTRACTOR's other obligations under the Contract Documents, whether it is to be performed by CONTRACTOR, any Subcontractor or Supplier, or by anyone directly or indirectly employed by any of them to

perform any of the Work, or by anyone for whose acts any of them may be liable:

1. claims under workers' compensation, disability benefits, and other similar employee benefit acts;
2. claims for damages because of bodily injury, occupational sickness or disease, or death of CONTRACTOR's employees;
3. claims for damages because of bodily injury, sickness or disease, or death of any person other than CONTRACTOR's employees;
4. claims for damages insured by reasonably available personal injury liability coverage which are sustained: (i) by any person as a result of an offense directly or indirectly related to the employment of such person by CONTRACTOR, or (ii) by any other person for any other reason;
5. claims for damages, other than to the Work itself, because of injury to or destruction of tangible property wherever located, including loss of use resulting therefrom; and
6. claims for damages because of bodily injury or death of any person or property damage arising out of the ownership, maintenance or use of any motor vehicle.

B. The policies of insurance so required by this paragraph 5.04 to be purchased and maintained shall:

\*See Supplementary Conditions

1. with respect to insurance required by paragraphs 5.04.A.3 through 5.04.A.6 inclusive, include as additional insureds (subject to any customary exclusion in respect of professional liability) OWNER, ENGINEER, ENGINEER's Consultants, and any other individuals or entities identified in the Supplementary Conditions, all of whom shall be listed as additional insureds, and include coverage for the respective officers, directors, partners, employees, agents, and other consultants and subcontractors of each and any of all such additional insureds, and the insurance afforded to these additional insureds shall provide primary coverage for all claims covered thereby;

2. include at least the specific coverages and be written for not less than the limits of liability provided in the Supplementary Conditions or required by Laws or Regulations, whichever is greater;

3. include completed operations insurance;

4. include contractual liability insurance covering CONTRACTOR's indemnity obligations under paragraphs 6.07, 6.11, and 6.20;

5. contain a provision or endorsement that the coverage afforded will not be canceled, materially changed or renewal refused until at least thirty days prior written notice has been given to OWNER and CONTRACTOR and to each other additional insured identified in the Supplementary Conditions to whom a certificate of insurance has been issued (and the certificates of insurance furnished by the CONTRACTOR pursuant to paragraph 5.03 will so provide);

6. remain in effect at least until final payment and at all times thereafter when CONTRACTOR may be correcting, removing, or replacing defective Work in accordance with paragraph 13.07; and

7. with respect to completed operations insurance, and any insurance coverage written on a claims-made basis, remain in effect for at least two years after final payment (and CONTRACTOR shall furnish OWNER and each other additional insured identified in the Supplementary Conditions, to whom a certificate of insurance has been issued, evidence satisfactory to OWNER and any such additional insured of continuation of such insurance at final payment and one year thereafter).

#### 5.05 *OWNER's Liability Insurance*

A.\* In addition to the insurance required to be provided by CONTRACTOR under paragraph 5.04, OWNER, at OWNER's option, may purchase and maintain at OWNER's expense OWNER's own liability insurance as will protect OWNER against claims which may arise from operations under the Contract Documents.

#### 5.06\* *Property Insurance*

A. Unless otherwise provided in the Supplementary Conditions, OWNER shall purchase and maintain property

insurance upon the Work at the Site in the amount of the full replacement cost thereof (subject to such deductible amounts as may be provided in the Supplementary Conditions or required by Laws and Regulations). This insurance shall:

1. include the interests of OWNER, CONTRACTOR, Subcontractors, ENGINEER, ENGINEER's Consultants, and any other individuals or entities identified in the Supplementary Conditions, and the officers, directors, partners, employees, agents, and other consultants and subcontractors of each and any of them, each of whom is deemed to have an insurable interest and shall be listed as an additional insured;

2. be written on a Builder's Risk "all-risk" or open peril or special causes of loss policy form that shall at least include insurance for physical loss or damage to the Work, temporary buildings, false work, and materials and equipment in transit, and shall insure against at least the following perils or causes of loss: fire, lightning, extended coverage, theft, vandalism and malicious mischief, earthquake, collapse, debris removal, demolition occasioned by enforcement of Laws and Regulations, water damage, and such other perils or causes of loss as may be specifically required by the Supplementary Conditions;

3. include expenses incurred in the repair or replacement of any insured property (including but not limited to fees and charges of engineers and architects);

\*See Supplementary Conditions

4. cover materials and equipment stored at the Site or at another location that was agreed to in writing by OWNER prior to being incorporated in the Work, provided that such materials and equipment have been included in an Application for Payment recommended by ENGINEER;

5. allow for partial utilization of the Work by OWNER;

6. include testing and startup; and

7. be maintained in effect until final payment is made unless otherwise agreed to in writing by OWNER, CONTRACTOR, and ENGINEER with

30 days written notice to each other additional insured to whom a certificate of insurance has been issued.

B.\* OWNER shall purchase and maintain such boiler and machinery insurance or additional property insurance as may be required by the Supplementary Conditions or Laws and Regulations which will include the interests of OWNER, CONTRACTOR, Subcontractors, ENGINEER, ENGINEER's Consultants, and any other individuals or entities identified in the Supplementary Conditions, each of whom is deemed to have an insurable interest and shall be listed as an insured or additional insured.

C.\* All the policies of insurance (and the certificates or other evidence thereof) required to be purchased and maintained in accordance with paragraph 5.06 will contain a provision or endorsement that the coverage afforded will not be canceled or materially changed or renewal refused until at least 30 days prior written notice has been given to OWNER and CONTRACTOR and to each other additional insured to whom a certificate of insurance has been issued and will contain waiver provisions in accordance with paragraph 5.07.

D.\* OWNER shall not be responsible for purchasing and maintaining any property insurance specified in this paragraph 5.06 to protect the interests of CONTRACTOR, Subcontractors, or others in the Work to the extent of any deductible amounts that are identified in the Supplementary Conditions. The risk of loss within such identified deductible amount will be borne by CONTRACTOR, Subcontractors, or others suffering any such loss, and if any of them wishes property insurance coverage within the limits of such amounts, each may purchase and maintain it at the purchaser's own expense.

E.\* If CONTRACTOR requests in writing that other special insurance be included in the property insurance policies provided under paragraph 5.06, OWNER shall, if possible, include such insurance, and the cost thereof will be charged to CONTRACTOR by appropriate Change Order or Written Amendment. Prior to commencement of the Work at the Site, OWNER shall in writing advise CONTRACTOR whether or not such other insurance has been procured by OWNER.

#### 5.07 *Waiver of Rights*

A.\* OWNER and CONTRACTOR intend that all policies purchased in accordance with paragraph 5.06 will protect OWNER, CONTRACTOR, Subcontractors, ENGINEER, ENGINEER's Consultants, and all other

individuals or entities identified in the Supplementary Conditions to be listed as insureds or additional insureds (and the officers, directors, partners, employees, agents, and other consultants and subcontractors of each and any of them) in such policies and will provide primary coverage for all losses and damages caused by the perils or causes of loss covered thereby. All such policies shall contain provisions to the effect that in the event of payment of any loss or damage the insurers will have no rights of recovery against any of the insureds or additional insureds thereunder. OWNER and CONTRACTOR waive all rights against each other and their respective officers, directors, partners, employees, agents, and other consultants and subcontractors of each and any of them for all losses and damages caused by, arising out of or resulting from any of the perils or causes of loss covered by such policies and any other property insurance applicable to the Work; and, in addition, waive all such rights against Subcontractors, ENGINEER, ENGINEER's Consultants, and all other individuals or entities identified in the Supplementary Conditions to be listed as insureds or additional insureds (and the officers, directors, partners, employees, agents, and other consultants and subcontractors of each and any of them) under such policies for losses and damages so caused.

None of the above waivers shall extend to the rights that any party making such waiver may have to the proceeds of insurance held by OWNER as trustee or otherwise payable under any policy so issued.

B. OWNER waives all rights against CONTRACTOR, Subcontractors, ENGINEER, ENGINEER's Consultants, and the officers, directors, partners, employees, agents, and other consultants and subcontractors of each and any of them for:

\*See Supplementary Conditions

1. loss due to business interruption, loss of use, or other consequential loss extending beyond direct physical loss or damage to OWNER's property or the Work caused by, arising out of, or resulting from fire or other peril whether or not insured by OWNER; and

2. loss or damage to the completed Project or part thereof caused by, arising out of, or resulting from fire or other insured peril or cause of loss covered by any property insurance maintained on the completed Project or part thereof by OWNER during partial utilization pursuant to

paragraph 14.05, after Substantial Completion pursuant to paragraph 14.04, or after final payment pursuant to paragraph 14.07.

C. Any insurance policy maintained by OWNER covering any loss, damage or consequential loss referred to in paragraph 5.07.B shall contain provisions to the effect that in the event of payment of any such loss, damage, or consequential loss, the insurers will have no rights of recovery against CONTRACTOR, Subcontractors, ENGINEER, or ENGINEER's Consultants and the officers, directors, partners, employees, agents, and other consultants and subcontractors of each and any of them.

#### 5.08\* *Receipt and Application of Insurance Proceeds*

A.\* Any insured loss under the policies of insurance required by paragraph 5.06 will be adjusted with OWNER and made payable to OWNER as fiduciary for the insureds, as their interests may appear, subject to the requirements of any applicable mortgage clause and of paragraph 5.08.B. OWNER shall deposit in a separate account any money so received and shall distribute it in accordance with such agreement as the parties in interest may reach. If no other special agreement is reached, the damaged Work shall be repaired or replaced, the moneys so received applied on account thereof, and the Work and the cost thereof covered by an appropriate Change Order or Written Amendment.

B.\* OWNER as fiduciary shall have power to adjust and settle any loss with the insurers unless one of the parties in interest shall object in writing within 15 days after the occurrence of loss to OWNER's exercise of this power. If such objection be made, OWNER as fiduciary shall make settlement with the insurers in accordance with such agreement as the parties in interest may reach. If no such agreement among the parties in interest is reached, OWNER as fiduciary shall adjust and settle the loss with the insurers and, if required in writing by any party in interest, OWNER as fiduciary shall give bond for the proper performance of such duties.

#### 5.09\* *Acceptance of Bonds and Insurance; Option to Replace*

A.\* If either OWNER or CONTRACTOR has any objection to the coverage afforded by or other provisions of the Bonds or insurance required to be purchased and maintained by the other party in accordance with Article 5 on the basis of non-conformance with the Contract Documents, the objecting party shall so notify the other party in writing within 10 days after receipt of the

certificates (or other evidence requested) required by paragraph 2.05.C. OWNER and CONTRACTOR shall each provide to the other such additional information in respect of insurance provided as the other may reasonably request. If either party does not purchase or maintain all of the Bonds and insurance required of such party by the Contract Documents, such party shall notify the other party in writing of such failure to purchase prior to the start of the Work, or of such failure to maintain prior to any change in the required coverage. Without prejudice to any other right or remedy, the other party may elect to obtain equivalent Bonds or insurance to protect such other party's interests at the expense of the party who was required to provide such coverage, and a Change Order shall be issued to adjust the Contract Price accordingly.

#### 5.10 *Partial Utilization, Acknowledgment of Property Insurer*

A. If OWNER finds it necessary to occupy or use a portion or portions of the Work prior to Substantial Completion of all the Work as provided in paragraph 14.05, no such use or occupancy shall commence before the insurers providing the property insurance pursuant to paragraph 5.06 have acknowledged notice thereof and in writing effected any changes in coverage necessitated thereby. The insurers providing the property insurance shall consent by endorsement on the policy or policies, but the property insurance shall not be canceled or permitted to lapse on account of any such partial use or occupancy.

### ARTICLE 6 - CONTRACTOR'S RESPONSIBILITIES

---

#### 6.01 *Supervision and Superintendence*

A. CONTRACTOR shall supervise, inspect, and direct the Work competently and efficiently, devoting such attention thereto and applying such skills and expertise as may be necessary to perform the Work in accordance with

\*See Supplementary Conditions

the Contract Documents. CONTRACTOR shall be solely responsible for the means, methods, techniques, sequences, and procedures of construction, but CONTRACTOR shall not be responsible for the negligence of OWNER or ENGINEER in the design or specification of a specific means, method, technique, sequence, or procedure of

construction which is shown or indicated in and expressly required by the Contract Documents. CONTRACTOR shall be responsible to see that the completed Work complies accurately with the Contract Documents.

B. At all times during the progress of the Work, CONTRACTOR shall assign a competent resident superintendent thereto who shall not be replaced without written notice to OWNER and ENGINEER except under extraordinary circumstances. The superintendent will be CONTRACTOR's representative at the Site and shall have authority to act on behalf of CONTRACTOR. All communications given to or received from the superintendent shall be binding on CONTRACTOR.

#### 6.02 *Labor; Working Hours*

A. CONTRACTOR shall provide competent, suitably qualified personnel to survey, lay out, and construct the

Work as required by the Contract Documents. CONTRACTOR shall at all times maintain good discipline and order at the Site.

B. Except as otherwise required for the safety or protection of persons or the Work or property at the Site or adjacent thereto, and except as otherwise stated in the Contract Documents, all Work at the Site shall be performed during regular working hours, and CONTRACTOR will not permit overtime work or the performance of Work on Saturday, Sunday, or any legal holiday without OWNER's written consent (which will not be unreasonably withheld) given after prior written notice to ENGINEER.

#### 6.03 *Services, Materials, and Equipment*

A. Unless otherwise specified in the General Requirements, CONTRACTOR shall provide and assume full responsibility for all services, materials, equipment, labor, transportation, construction equipment and machinery, tools, appliances, fuel, power, light, heat, telephone, water, sanitary facilities, temporary facilities, and all other facilities and incidentals necessary for the performance, testing, start-up, and completion of the Work.

B. All materials and equipment incorporated into the Work shall be as specified or, if not specified, shall be of good quality and new, except as otherwise provided in the Contract Documents. All warranties and guarantees specifically called for by the Specifications shall expressly

run to the benefit of OWNER. If required by ENGINEER, CONTRACTOR shall furnish satisfactory evidence (including reports of required tests) as to the source, kind, and quality of materials and equipment. All materials and equipment shall be stored, applied, installed, connected, erected, protected, used, cleaned, and conditioned in accordance with instructions of the applicable Supplier, except as otherwise may be provided in the Contract Documents.

#### 6.04 *Progress Schedule*

A. CONTRACTOR shall adhere to the progress schedule established in accordance with paragraph 2.07 as it may be adjusted from time to time as provided below.

1. CONTRACTOR shall submit to ENGINEER for acceptance (to the extent indicated in paragraph 2.07) proposed adjustments in the progress schedule that will not result in changing the Contract Times (or Milestones). Such adjustments will conform generally to the progress schedule then in effect and additionally will comply with any provisions of the General Requirements applicable thereto.

2. Proposed adjustments in the progress schedule that will change the Contract Times (or Milestones) shall be submitted in accordance with the requirements of Article 12. Such adjustments may only be made by a Change Order or Written Amendment in accordance with Article 12.

#### 6.05 *Substitutes and "Or-Equals"*

A. Whenever an item of material or equipment is specified or described in the Contract Documents by using the name of a proprietary item or the name of a particular Supplier, the specification or description is intended to establish the type, function, appearance, and quality required. Unless the specification or description contains or is followed by words reading that no like, equivalent, or "or-equal" item or no substitution is permitted, other items of material or equipment or material or equipment of other Suppliers may be submitted to ENGINEER for review under the circumstances described below.

1. *"Or-Equal" Items:* If in ENGINEER's sole discretion an item of material or equipment proposed by CONTRACTOR is functionally equal to that named and sufficiently similar so that no change in related Work will be required, it may be

considered by ENGINEER as an "or-equal" item, in which case review and approval of the proposed item may, in ENGINEER's sole discretion, be accomplished without compliance with some or all of the requirements for approval of proposed substitute items. For the purposes of this paragraph 6.05.A.1, a proposed item of material or equipment will be considered functionally equal to an item so named if:

a. in the exercise of reasonable judgment ENGINEER determines that: (i) it is at least equal in quality, durability, appearance, strength, and design characteristics; (ii) it will reliably perform at least equally well the function imposed by the design concept of the completed Project as a functioning whole, and;

b. CONTRACTOR certifies that: (i) there is no increase in cost to the OWNER; and (ii) it will conform substantially, even with deviations, to the detailed requirements of the item named in the Contract Documents.

#### 2. *Substitute Items*

a. If in ENGINEER's sole discretion an item of material or equipment proposed by CONTRACTOR does not qualify as an "or-equal" item under paragraph 6.05.A.1, it will be considered a proposed substitute item.

b. CONTRACTOR shall submit sufficient information as provided below to allow ENGINEER to determine that the item of material or equipment proposed is essentially equivalent to that named and an acceptable substitute therefor. Requests for review of proposed substitute items of material or equipment will not be accepted by ENGINEER from anyone other than CONTRACTOR.

c. The procedure for review by ENGINEER will be as set forth in paragraph 6.05.A.2.d, as supplemented in the General Requirements and as ENGINEER may decide is appropriate under the circumstances.

d. CONTRACTOR shall first make written application to ENGINEER for review of a proposed substitute item of material or equipment that CONTRACTOR seeks to furnish or use. The application shall certify

that the proposed substitute item will perform adequately the functions and achieve the results called for by the general design, be similar in substance to that specified, and be suited to the same use as that specified. The application will state the extent, if any, to which the use of the proposed substitute item will prejudice CONTRACTOR's achievement of Substantial Completion on time, whether or not use of the proposed substitute item in the Work will require a change in any of the Contract Documents (or in the provisions of any other direct contract with OWNER for work on the Project) to adapt the design to the proposed substitute item and whether or not incorporation or use of the proposed substitute item in connection with the Work is subject to payment of any license fee or royalty. All variations of the proposed substitute item from that specified will be identified in the application, and available engineering, sales, maintenance, repair, and replacement services will be indicated. The application will also contain an itemized estimate of all costs or credits that will result directly or indirectly from use of such substitute item, including costs of redesign and claims of other contractors affected by any resulting change, all of which will be considered by ENGINEER in evaluating the proposed substitute item. ENGINEER may require CONTRACTOR to furnish additional data about the proposed substitute item.

*B. Substitute Construction Methods or Procedures:*

If a specific means, method, technique, sequence, or procedure of construction is shown or indicated in and expressly required by the Contract Documents, CONTRACTOR may furnish or utilize a substitute means, method, technique, sequence, or procedure of construction approved by ENGINEER. CONTRACTOR shall submit sufficient information to allow ENGINEER, in ENGINEER's sole discretion, to determine that the substitute proposed is equivalent to that expressly called for by the Contract Documents. The procedure for review by ENGINEER will be similar to that provided in subparagraph 6.05.A.2.

*C. Engineer's Evaluation:* ENGINEER will be allowed a reasonable time within which to evaluate each proposal or submittal made pursuant to paragraphs 6.05.A and 6.05.B. ENGINEER will be the sole judge of acceptability. No "or-equal" or substitute will be ordered, installed or utilized until ENGINEER's review is complete, which will be evidenced by either a Change Order for a

substitute or an approved Shop Drawing for an "or equal." ENGINEER will advise CONTRACTOR in writing of any negative determination.

*D. Special Guarantee:* OWNER may require CONTRACTOR to furnish at CONTRACTOR's expense a special performance guarantee or other surety with respect to any substitute.

*E. ENGINEER's Cost Reimbursement:* ENGINEER will record time required by ENGINEER and ENGINEER's Consultants in evaluating substitute proposed or submitted by CONTRACTOR pursuant to paragraphs 6.05.A.2 and 6.05.B and in making changes in the Contract Documents (or in the provisions of any other direct contract with OWNER for work on the Project) occasioned thereby. Whether or not ENGINEER approves a substitute item so proposed or submitted by CONTRACTOR, CONTRACTOR shall reimburse OWNER for the charges of ENGINEER and ENGINEER's Consultants for evaluating each such proposed substitute.

*F. CONTRACTOR's Expense:* CONTRACTOR shall provide all data in support of any proposed substitute or "or-equal" at CONTRACTOR's expense.

*6.06 Concerning Subcontractors, Suppliers, and Others*

A. CONTRACTOR shall not employ any Subcontractor, Supplier, or other individual or entity (including those acceptable to OWNER as indicated in paragraph 6.06.B), whether initially or as a replacement, against whom OWNER may have reasonable objection. CONTRACTOR shall not be required to employ any Subcontractor, Supplier, or other individual or entity to furnish or perform any of the Work against whom CONTRACTOR has reasonable objection.

B. If the Supplementary Conditions require the identity of certain Subcontractors, Suppliers, or other individuals or entities to be submitted to OWNER in advance for acceptance by OWNER by a specified date prior to the Effective Date of the Agreement, and if CONTRACTOR has submitted a list thereof in accordance with the Supplementary Conditions, OWNER's acceptance (either in writing or by failing to make written objection thereto by the date indicated for acceptance or objection in the Bidding Documents or the Contract Documents) of any such Subcontractor, Supplier, or other individual or entity so identified may be revoked on the basis of reasonable objection after due investigation. CONTRACTOR shall submit an acceptable replacement

for the rejected Subcontractor, Supplier, or other individual or entity, and the Contract Price will be adjusted by the difference in the cost occasioned by such replacement, and an appropriate Change Order will be issued or Written Amendment signed. No acceptance by OWNER of any such Subcontractor, Supplier, or other individual or entity, whether initially or as a replacement, shall constitute a waiver of any right of OWNER or ENGINEER to reject defective Work.

C. CONTRACTOR shall be fully responsible to OWNER and ENGINEER for all acts and omissions of the Subcontractors, Suppliers, and other individuals or entities performing or furnishing any of the Work just as CONTRACTOR is responsible for CONTRACTOR's own acts and omissions. Nothing in the Contract Documents shall create for the benefit of any such Subcontractor, Supplier, or other individual or entity any contractual relationship between OWNER or ENGINEER and any such Subcontractor, Supplier or other individual or entity, nor shall it create any obligation on the part of OWNER or ENGINEER to pay or to see to the payment of any moneys due any such Subcontractor, Supplier, or other individual or entity except as may otherwise be required by Laws and Regulations.

D. CONTRACTOR shall be solely responsible for scheduling and coordinating the Work of Subcontractors, Suppliers, and other individuals or entities performing or furnishing any of the Work under a direct or indirect contract with CONTRACTOR.

E. CONTRACTOR shall require all Subcontractors, Suppliers, and such other individuals or entities performing or furnishing any of the Work to communicate with ENGINEER through CONTRACTOR.

F. The divisions and sections of the Specifications and the identifications of any Drawings shall not control CONTRACTOR in dividing the Work among Subcontractors or Suppliers or delineating the Work to be performed by any specific trade.

G. All Work performed for CONTRACTOR by a Subcontractor or Supplier will be pursuant to an appropriate agreement between CONTRACTOR and the Subcontractor or Supplier which specifically binds the Subcontractor or Supplier to the applicable terms and conditions of the Contract Documents for the benefit of OWNER and ENGINEER. Whenever any such agreement is with a Subcontractor or Supplier who is listed as an additional insured on the property insurance provided in paragraph 5.06, the agreement between the CONTRAC-

TOR and the Subcontractor or Supplier will contain provisions whereby the Subcontractor or Supplier waives all rights against OWNER, CONTRACTOR, ENGINEER, ENGINEER's Consultants, and all other individuals or entities identified in the Supplementary Conditions to be listed as insureds or additional insureds (and the officers, directors, partners, employees, agents, and other consultants and subcontractors of each and any of them) for all losses and damages caused by, arising out of, relating to, or resulting from any of the perils or causes of loss covered by such policies and any other property insurance applicable to the Work. If the insurers on any such policies require separate waiver forms to be signed by any Subcontractor or Supplier, CONTRACTOR will obtain the same.

#### 6.07 *Patent Fees and Royalties*

A. CONTRACTOR shall pay all license fees and royalties and assume all costs incident to the use in the performance of the Work or the incorporation in the Work of any invention, design, process, product, or device which is the subject of patent rights or copyrights held by others. If a particular invention, design, process, product, or device is specified in the Contract Documents for use in the performance of the Work and if to the actual knowledge of OWNER or ENGINEER its use is subject to patent rights or copyrights calling for the payment of any license fee or royalty to others, the existence of such rights shall be disclosed by OWNER in the Contract Documents. To the fullest extent permitted by Laws and Regulations, CONTRACTOR shall indemnify and hold harmless OWNER, ENGINEER, ENGINEER's Consultants, and the officers, directors, partners, employees or agents, and other consultants of each and any of them from and against all claims, costs, losses, and damages (including but not limited to all fees and charges of engineers, architects, attorneys, and other professionals and all court or arbitration or other dispute resolution costs) arising out of or relating to any infringement of patent rights or copyrights incident to the use in the performance of the Work or resulting from the incorporation in the Work of any invention, design, process, product, or device not specified in the Contract Documents.

#### 6.08 *Permits*

A. Unless otherwise provided in the Supplementary Conditions, CONTRACTOR shall obtain and pay for all construction permits and licenses. OWNER shall assist CONTRACTOR, when necessary, in obtaining such permits and licenses. CONTRACTOR shall pay all governmental charges and inspection fees necessary for

the prosecution of the Work which are applicable at the time of opening of Bids, or, if there are no Bids, on the Effective Date of the Agreement. CONTRACTOR shall pay all charges of utility owners for connections to the Work, and OWNER shall pay all charges of such utility owners for capital costs related thereto, such as plant investment fees.

#### 6.09 *Laws and Regulations*

A. CONTRACTOR shall give all notices and comply with all Laws and Regulations applicable to the performance of the Work. Except where otherwise expressly required by applicable Laws and Regulations, neither OWNER nor ENGINEER shall be responsible for monitoring CONTRACTOR's compliance with any Laws or Regulations.

B. If CONTRACTOR performs any Work knowing or having reason to know that it is contrary to Laws or Regulations, CONTRACTOR shall bear all claims, costs, losses, and damages (including but not limited to all fees and charges of engineers, architects, attorneys, and other professionals and all court or arbitration or other dispute resolution costs) arising out of or relating to such Work; however, it shall not be CONTRACTOR's primary responsibility to make certain that the Specifications and Drawings are in accordance with Laws and Regulations, but this shall not relieve CONTRACTOR of CONTRACTOR's obligations under paragraph 3.03.

C. Changes in Laws or Regulations not known at the time of opening of Bids (or, on the Effective Date of the Agreement if there were no Bids) having an effect on the cost or time of performance of the Work may be the subject of an adjustment in Contract Price or Contract Times. If OWNER and CONTRACTOR are unable to agree on entitlement to or on the amount or extent, if any, of any such adjustment, a Claim may be made therefor as provided in paragraph 10.05.

#### 6.10\* *Taxes*

A. CONTRACTOR shall pay all sales, consumer, use, and other similar taxes required to be paid by CONTRACTOR in accordance with the Laws and Regulations of the place of the Project which are applicable during the performance of the Work.

#### 6.11\* *Use of Site and Other Areas*

##### A.\* *Limitation on Use of Site and Other Areas*

1. CONTRACTOR shall confine construction equipment, the storage of materials and equipment, and the operations of workers to the Site and other areas permitted by Laws and Regulations,

\*See Supplementary Conditions

and shall not unreasonably encumber the Site and other areas with construction equipment or other materials or equipment. CONTRACTOR shall assume full responsibility for any damage to any such land or area, or to the owner or occupant thereof, or of any adjacent land or areas resulting from the performance of the Work.

2. Should any claim be made by any such owner or occupant because of the performance of the Work, CONTRACTOR shall promptly settle with such other party by negotiation or otherwise resolve the claim by arbitration or other dispute resolution proceeding or at law.

3. To the fullest extent permitted by Laws and Regulations, CONTRACTOR shall indemnify and hold harmless OWNER, ENGINEER, ENGINEER's Consultant, and the officers, directors, partners, employees, agents, and other consultants of each and any of them from and against all claims, costs, losses, and damages (including but not limited to all fees and charges of engineers, architects, attorneys, and other professionals and all court or arbitration or other dispute resolution costs) arising out of or relating to any claim or action, legal or equitable, brought by any such owner or occupant against OWNER, ENGINEER, or any other party indemnified hereunder to the extent caused by or based upon CONTRACTOR's performance of the Work.

B. *Removal of Debris During Performance of the Work:* During the progress of the Work CONTRACTOR shall keep the Site and other areas free from accumulations of waste materials, rubbish, and other debris. Removal and disposal of such waste materials, rubbish, and other debris shall conform to applicable Laws and Regulations.

C. *Cleaning*: Prior to Substantial Completion of the Work CONTRACTOR shall clean the Site and make it ready for utilization by OWNER. At the completion of the Work CONTRACTOR shall remove from the Site all tools, appliances, construction equipment and machinery, and surplus materials and shall restore to original condition all property not designated for alteration by the Contract Documents.

D. *Loading Structures*: CONTRACTOR shall not load nor permit any part of any structure to be loaded in any manner that will endanger the structure, nor shall CONTRACTOR subject any part of the Work or adjacent property to stresses or pressures that will endanger it.

#### 6.12 *Record Documents*

A. CONTRACTOR shall maintain in a safe place at the Site one record copy of all Drawings, Specifications, Addenda, Written Amendments, Change Orders, Work Change Directives, Field Orders, and written interpretations and clarifications in good order and annotated to show changes made during construction. These record documents together with all approved Samples and a counterpart of all approved Shop Drawings will be available to ENGINEER for reference. Upon completion of the Work, these record documents, Samples, and Shop Drawings will be delivered to ENGINEER for OWNER.

#### 6.13 *Safety and Protection*

A. CONTRACTOR shall be solely responsible for initiating, maintaining and supervising all safety precautions and programs in connection with the Work. CONTRACTOR shall take all necessary precautions for the safety of, and shall provide the necessary protection to prevent damage, injury or loss to:

1. all persons on the Site or who may be affected by the Work;
2. all the Work and materials and equipment to be incorporated therein, whether in storage on or off the Site; and
3. other property at the Site or adjacent thereto, including trees, shrubs, lawns, walks, pavements, roadways, structures, utilities, and Underground Facilities not designated for removal, relocation, or replacement in the course of construction.

B. CONTRACTOR shall comply with all applicable Laws and Regulations relating to the safety of persons or property, or to the protection of persons or property from damage, injury, or loss; and shall erect and maintain all necessary safeguards for such safety and protection. CONTRACTOR shall notify owners of adjacent property and of Underground Facilities and other utility owners when prosecution of the Work may affect them, and shall cooperate with them in the protection, removal, relocation, and replacement of their property. All damage, injury, or loss to any property referred to in paragraph 6.13.A.2 or 6.13.A.3 caused, directly or indirectly, in whole or in part, by CONTRACTOR, any Subcontractor, Supplier, or any other individual or entity directly or indirectly employed by any of them to perform any of the Work, or anyone for whose acts any of them may be liable, shall be remedied by CONTRACTOR (except damage or loss attributable to the fault of Drawings or Specifications or to the acts or omissions of OWNER or ENGINEER or ENGINEER's Consultant, or anyone employed by any of them, or anyone for whose acts any of them may be liable, and not attributable, directly or indirectly, in whole or in part, to the fault or negligence of CONTRACTOR or any Subcontractor, Supplier, or other individual or entity directly or indirectly employed by any of them). CONTRACTOR's duties and responsibilities for safety and for protection of the Work shall continue until such time as all the Work is completed and ENGINEER has issued a notice to OWNER and CONTRACTOR in accordance with paragraph 14.07.B that the Work is acceptable (except as otherwise expressly provided in connection with Substantial Completion).

#### 6.14 *Safety Representative*

A. CONTRACTOR shall designate a qualified and experienced safety representative at the Site whose duties and responsibilities shall be the prevention of accidents and the maintaining and supervising of safety precautions and programs.

#### 6.15 *Hazard Communication Programs*

A. CONTRACTOR shall be responsible for coordinating any exchange of material safety data sheets or other hazard communication information required to be made available to or exchanged between or among employers at the Site in accordance with Laws or Regulations.

#### 6.16 *Emergencies*

A. In emergencies affecting the safety or protection of persons or the Work or property at the Site or adjacent thereto, CONTRACTOR is obligated to act to prevent threatened damage, injury, or loss. CONTRACTOR shall give ENGINEER prompt written notice if CONTRACTOR believes that any significant changes in the Work or variations from the Contract Documents have been caused thereby or are required as a result thereof. If ENGINEER determines that a change in the Contract Documents is required because of the action taken by CONTRACTOR in response to such an emergency, a Work Change Directive or Change Order will be issued.

#### 6.17\* *Shop Drawings and Samples*

A.\* CONTRACTOR shall submit Shop Drawings to ENGINEER for review and approval in accordance with the acceptable schedule of Shop Drawings and Sample submittals. All submittals will be identified as ENGINEER may require and in the number of copies specified in the General Requirements. The data shown on the Shop Drawings will be complete with respect to quantities, dimensions, specified performance and design criteria, materials, and similar data to show ENGINEER the services, materials, and equipment CONTRACTOR proposes to provide and to enable ENGINEER to review the information for the limited purposes required by paragraph 6.17.E.

B.\* CONTRACTOR shall also submit six (6) Samples to ENGINEER for review and approval in accordance with the acceptable schedule of Shop Drawings and Sample submittals. Each Sample will be identified clearly as to material, Supplier, pertinent data such as catalog numbers, and the use for which intended and otherwise as ENGINEER may require to enable ENGINEER to review the submittal for the limited purposes required by paragraph 6.17.E. The numbers of each Sample to be submitted will be as specified in the Specifications.

C. Where a Shop Drawing or Sample is required by the Contract Documents or the schedule of Shop Drawings and Sample submittals acceptable to ENGINEER as required by paragraph 2.07, any related Work performed prior to ENGINEER's review and approval of the pertinent submittal will be at the sole expense and responsibility of CONTRACTOR.

#### D. *Submittal Procedures*

1. Before submitting each Shop Drawing or Sample, CONTRACTOR shall have determined and verified:

a. all field measurements, quantities, dimensions, specified performance criteria, installation requirements, materials, catalog numbers, and similar information with respect thereto;

b. all materials with respect to intended use, fabrication, shipping, handling, storage, assembly, and installation pertaining to the performance of the Work;

c. all information relative to means, methods, techniques, sequences, and procedures of construction and safety precautions and programs incident thereto; and

d. CONTRACTOR shall also have reviewed and coordinated each Shop Drawing or

\*See Supplementary Conditions

Sample with other Shop Drawings and Samples and with the requirements of the Work and the Contract Documents.

2. Each submittal shall bear a stamp or specific written indication that CONTRACTOR has satisfied CONTRACTOR's obligations under the Contract Documents with respect to CONTRACTOR's review and approval of that submittal.

3. At the time of each submittal, CONTRACTOR shall give ENGINEER specific written notice of such variations, if any, that the Shop Drawing or Sample submitted may have from the requirements of the Contract Documents, such notice to be in a written communication separate from the submittal; and, in addition, shall cause a specific notation to be made on each Shop Drawing and Sample submitted to ENGINEER for review and approval of each such variation.

#### E. *ENGINEER's Review*

1. ENGINEER will timely review and approve Shop Drawings and Samples in accordance with the schedule of Shop Drawings and Sample submittals acceptable to ENGINEER. ENGINEER's review and approval will be only to determine if the items covered by the submittals

will, after installation or incorporation in the Work, conform to the information given in the Contract Documents and be compatible with the design concept of the completed Project as a functioning whole as indicated by the Contract Documents.

2. ENGINEER's review and approval will not extend to means, methods, techniques, sequences, or procedures of construction (except where a particular means, method, technique, sequence, or procedure of construction is specifically and expressly called for by the Contract Documents) or to safety precautions or programs incident thereto. The review and approval of a separate item as such will not indicate approval of the assembly in which the item functions.

3. ENGINEER's review and approval of Shop Drawings or Samples shall not relieve CONTRACTOR from responsibility for any variation from the requirements of the Contract Documents unless CONTRACTOR has in writing called ENGINEER's attention to each such variation at the time of each submittal as required by paragraph 6.17.D.3 and ENGINEER has given written approval of each such variation by specific written notation thereof incorporated in or accompanying the Shop Drawing or Sample approval; nor will any approval by ENGINEER relieve CONTRACTOR from responsibility for complying with the requirements of paragraph 6.17.D.1.

#### F. Resubmittal Procedures

1. CONTRACTOR shall make corrections required by ENGINEER and shall return the required number of corrected copies of Shop Drawings and submit as required new Samples for review and approval. CONTRACTOR shall direct specific attention in writing to revisions other than the corrections called for by ENGINEER on previous submittals.

#### 6.18 Continuing the Work

A. CONTRACTOR shall carry on the Work and adhere to the progress schedule during all disputes or disagreements with OWNER. No Work shall be delayed or postponed pending resolution of any disputes or disagreements, except as permitted by paragraph 15.04 or as OWNER and CONTRACTOR may otherwise agree in writing.

#### 6.19 CONTRACTOR's General Warranty and Guarantee

A. CONTRACTOR warrants and guarantees to OWNER, ENGINEER, and ENGINEER's Consultants that all Work will be in accordance with the Contract Documents and will not be defective. CONTRACTOR's warranty and guarantee hereunder excludes defects or damage caused by:

1. abuse, modification, or improper maintenance or operation by persons other than CONTRACTOR, Subcontractors, Suppliers, or any other individual or entity for whom CONTRACTOR is responsible; or

2. normal wear and tear under normal usage.

B. CONTRACTOR's obligation to perform and complete the Work in accordance with the Contract Documents shall be absolute. None of the following will constitute an acceptance of Work that is not in accordance with the Contract Documents or a release of CONTRACTOR's obligation to perform the Work in accordance with the Contract Documents:

1. observations by ENGINEER;

2. recommendation by ENGINEER or payment by OWNER of any progress or final payment;

3. the issuance of a certificate of Substantial Completion by ENGINEER or any payment related thereto by OWNER;

4. use or occupancy of the Work or any part thereof by OWNER;

5. any acceptance by OWNER or any failure to do so;

6. any review and approval of a Shop Drawing or Sample submittal or the issuance of a notice of acceptability by ENGINEER;

7. any inspection, test, or approval by others; or

8. any correction of defective Work by OWNER.

6.20 *Indemnification*

A. To the fullest extent permitted by Laws and Regulations, CONTRACTOR shall indemnify and hold harmless OWNER, ENGINEER, ENGINEER's Consultants, and the officers, directors, partners, employees, agents, and other consultants and subcontractors of each and any of them from and against all claims, costs, losses, and damages (including but not limited to all fees and charges of engineers, architects, attorneys, and other professionals and all court or arbitration or other dispute resolution costs) arising out of or relating to the performance of the Work, provided that any such claim, cost, loss, or damage:

1. is attributable to bodily injury, sickness, disease, or death, or to injury to or destruction of tangible property (other than the Work itself), including the loss of use resulting therefrom; and

2. is caused in whole or in part by any negligent act or omission of CONTRACTOR, any Subcontractor, any Supplier, or any individual or entity directly or indirectly employed by any of them to perform any of the Work or anyone for whose acts any of them may be liable, regardless of whether or not caused in part by any negligence or omission of an individual or entity indemnified hereunder or whether liability is imposed upon such indemnified party by Laws and Regulations regardless of the negligence of any such individual or entity.

B. In any and all claims against OWNER or ENGINEER or any of their respective consultants, agents, officers, directors, partners, or employees by any employee (or the survivor or personal representative of such employee) of CONTRACTOR, any Subcontractor, any Supplier, or any individual or entity directly or indirectly employed by any of them to perform any of the Work, or anyone for whose acts any of them may be liable, the indemnification obligation under paragraph 6.20.A shall not be limited in any way by any limitation on the amount or type of damages, compensation, or benefits payable by or for CONTRACTOR or any such Subcontractor, Supplier, or other individual or entity under workers' compensation acts, disability benefit acts, or other employee benefit acts.

C. The indemnification obligations of CONTRACTOR under paragraph 6.20.A shall not extend to the liability of ENGINEER and ENGINEER's Consultants or to the officers, directors, partners, employees, agents, and

other consultants and subcontractors of each and any of them arising out of:

1. the preparation or approval of, or the failure to prepare or approve, maps, Drawings, opinions, reports, surveys, Change Orders, designs, or Specifications; or

2. giving directions or instructions, or failing to give them, if that is the primary cause of the injury or damage.

ARTICLE 7 - OTHER WORK

---

7.01 *Related Work at Site*

A. OWNER may perform other work related to the Project at the Site by OWNER's employees, or let other direct contracts therefor, or have other work performed by utility owners. If such other work is not noted in the Contract Documents, then:

1. written notice thereof will be given to CONTRACTOR prior to starting any such other work; and

2. if OWNER and CONTRACTOR are unable to agree on entitlement to or on the amount or extent, if any, of any adjustment in the Contract Price or Contract Times that should be allowed as a result of such other work, a Claim may be made therefor as provided in paragraph 10.05.

B. CONTRACTOR shall afford each other contractor who is a party to such a direct contract and each utility owner (and OWNER, if OWNER is performing the other work with OWNER's employees) proper and safe access to the Site and a reasonable opportunity for the introduction and storage of materials and equipment and the execution of such other work and shall properly coordinate the Work with theirs. Unless otherwise provided in the Contract Documents, CONTRACTOR shall do all cutting, fitting, and patching of the Work that may be required to properly connect or otherwise make its several parts come together and properly integrate with such other work. CONTRACTOR shall not endanger any work of others by cutting, excavating, or otherwise altering their work and will only cut or alter their work with the written consent of ENGINEER and the others whose work will be affected. The duties and responsibilities of CONTRACTOR under this paragraph are for the benefit of

such utility owners and other contractors to the extent that there are comparable provisions for the benefit of CONTRACTOR in said direct contracts between OWNER and such utility owners and other contractors.

C. If the proper execution or results of any part of CONTRACTOR's Work depends upon work performed by others under this Article 7, CONTRACTOR shall inspect such other work and promptly report to ENGINEER in writing any delays, defects, or deficiencies in such other work that render it unavailable or unsuitable for the proper execution and results of CONTRACTOR's Work. CONTRACTOR's failure to so report will constitute an acceptance of such other work as fit and proper for integration with CONTRACTOR's Work except for latent defects and deficiencies in such other work.

#### 7.02 *Coordination*

A. If OWNER intends to contract with others for the performance of other work on the Project at the Site, the following will be set forth in Supplementary Conditions:

1. the individual or entity who will have authority and responsibility for coordination of the activities among the various contractors will be identified;
2. the specific matters to be covered by such authority and responsibility will be itemized; and
3. the extent of such authority and responsibilities will be provided.

B. Unless otherwise provided in the Supplementary Conditions, OWNER shall have sole authority and responsibility for such coordination.

### ARTICLE 8 - OWNER'S RESPONSIBILITIES

---

#### 8.01 *Communications to Contractor*

A. Except as otherwise provided in these General Conditions, OWNER shall issue all communications to CONTRACTOR through ENGINEER.

#### 8.02 *Replacement of ENGINEER*

A. In case of termination of the employment of ENGINEER, OWNER shall appoint an engineer to whom CONTRACTOR makes no reasonable objection, whose status under the Contract Documents shall be that of the former ENGINEER.

#### 8.03 *Furnish Data*

A. OWNER shall promptly furnish the data required of OWNER under the Contract Documents.

#### 8.04 *Pay Promptly When Due*

A. OWNER shall make payments to CONTRACTOR promptly when they are due as provided in paragraphs 14.02.C and 14.07.C.

#### 8.05 *Lands and Easements; Reports and Tests*

A. OWNER's duties in respect of providing lands and easements and providing engineering surveys to establish reference points are set forth in paragraphs 4.01 and 4.05. Paragraph 4.02 refers to OWNER's identifying and making available to CONTRACTOR copies of reports of explorations and tests of subsurface conditions and drawings of physical conditions in or relating to existing surface or subsurface structures at or contiguous to the Site that have been utilized by ENGINEER in preparing the Contract Documents.

\*See Supplementary Conditions

#### 8.06\* *Insurance*

A.\* OWNER's responsibilities, if any, in respect to purchasing and maintaining liability and property insurance are set forth in Article 5.

#### 8.07 *Change Orders*

A. OWNER is obligated to execute Change Orders as indicated in paragraph 10.03.

#### 8.08 *Inspections, Tests, and Approvals*

A. OWNER's responsibility in respect to certain inspections, tests, and approvals is set forth in paragraph 13.03.B.

8.09 *Limitations on OWNER's Responsibilities*

A. The OWNER shall not supervise, direct, or have control or authority over, nor be responsible for, CONTRACTOR's means, methods, techniques, sequences, or procedures of construction, or the safety precautions and programs incident thereto, or for any failure of CONTRACTOR to comply with Laws and Regulations applicable to the performance of the Work. OWNER will not be responsible for CONTRACTOR's failure to perform the Work in accordance with the Contract Documents.

8.10 *Undisclosed Hazardous Environmental Condition*

A. OWNER's responsibility in respect to an undisclosed Hazardous Environmental Condition is set forth in paragraph 4.06.

8.11 *Evidence of Financial Arrangements*

A. If and to the extent OWNER has agreed to furnish CONTRACTOR reasonable evidence that financial arrangements have been made to satisfy OWNER's obligations under the Contract Documents, OWNER's responsibility in respect thereof will be as set forth in the Supplementary Conditions.

ARTICLE 9 - ENGINEER'S STATUS DURING CONSTRUCTION

---

9.01 *OWNER'S Representative*

A. ENGINEER will be OWNER's representative during the construction period. The duties and responsibilities and the limitations of authority of ENGINEER as OWNER's representative during construction are set forth in the Contract Documents and will not be changed without written consent of OWNER and ENGINEER.

9.02 *Visits to Site*

A. ENGINEER will make visits to the Site at intervals appropriate to the various stages of construction as ENGINEER deems necessary in order to observe as an experienced and qualified design professional the progress that has been made and the quality of the various aspects of CONTRACTOR's executed Work. Based on information obtained during such visits and

observations, ENGINEER, for the benefit of OWNER, will determine, in general, if the Work is proceeding in accordance with the Contract Documents. ENGINEER will not be required to make exhaustive or continuous inspections on the Site to check the quality or quantity of the Work. ENGINEER's efforts will be directed toward providing for OWNER a greater degree of confidence that the completed Work will conform generally to the Contract Documents. On the basis of such visits and observations, ENGINEER will keep OWNER informed of the progress of the Work and will endeavor to guard OWNER against defective Work.

B. ENGINEER's visits and observations are subject to all the limitations on ENGINEER's authority and responsibility set forth in paragraph 9.10, and particularly, but without limitation, during or as a result of ENGINEER's visits or observations of CONTRACTOR's Work ENGINEER will not supervise, direct, control, or have authority over or be responsible for CONTRACTOR's means, methods, techniques, sequences, or procedures of construction, or the safety precautions and programs incident thereto, or for any failure of CONTRACTOR to comply with Laws and Regulations applicable to the performance of the Work.

9.03\* *Project Representative*

A. If OWNER and ENGINEER agree, ENGINEER will furnish a Resident Project Representative to assist ENGINEER in providing more extensive observation of the Work. The responsibilities and authority and limitations thereon of any such Resident Project Representative and assistants will be as provided in paragraph 9.10 and in the Supplementary Conditions. If OWNER designates another representative or agent to represent OWNER at the Site who is not ENGINEER's Consultant, agent or employee,

\*See Supplementary Conditions

the responsibilities and authority and limitations thereon of such other individual or entity will be as provided in the Supplementary Conditions.

9.04 *Clarifications and Interpretations*

A. ENGINEER will issue with reasonable promptness such written clarifications or interpretations of the requirements of the Contract Documents as ENGINEER may determine necessary, which shall be consistent with the intent of and reasonably inferable from the Contract Docu-

ments. Such written clarifications and interpretations will be binding on OWNER and CONTRACTOR. If OWNER and CONTRACTOR are unable to agree on entitlement to or on the amount or extent, if any, of any adjustment in the Contract Price or Contract Times, or both, that should be allowed as a result of a written clarification or interpretation, a Claim may be made therefor as provided in paragraph 10.05.

#### 9.05 *Authorized Variations in Work*

A. ENGINEER may authorize minor variations in the Work from the requirements of the Contract Documents which do not involve an adjustment in the Contract Price or the Contract Times and are compatible with the design concept of the completed Project as a functioning whole as indicated by the Contract Documents. These may be accomplished by a Field Order and will be binding on OWNER and also on CONTRACTOR, who shall perform the Work involved promptly. If OWNER and CONTRACTOR are unable to agree on entitlement to or on the amount or extent, if any, of any adjustment in the Contract Price or Contract Times, or both, as a result of a Field Order, a Claim may be made therefor as provided in paragraph 10.05.

#### 9.06 *Rejecting Defective Work*

A. ENGINEER will have authority to disapprove or reject Work which ENGINEER believes to be defective, or that ENGINEER believes will not produce a completed Project that conforms to the Contract Documents or that will prejudice the integrity of the design concept of the completed Project as a functioning whole as indicated by the Contract Documents. ENGINEER will also have authority to require special inspection or testing of the Work as provided in paragraph 13.04, whether or not the Work is fabricated, installed, or completed.

#### 9.07 *Shop Drawings, Change Orders and Payments*

A. In connection with ENGINEER's authority as to Shop Drawings and Samples, see paragraph 6.17.

B. In connection with ENGINEER's authority as to Change Orders, see Articles 10, 11, and 12.

C. In connection with ENGINEER's authority as to Applications for Payment, see Article 14.

#### 9.08 *Determinations for Unit Price Work*

A. ENGINEER will determine the actual quantities and classifications of Unit Price Work performed by CONTRACTOR. ENGINEER will review with CONTRACTOR the ENGINEER's preliminary determinations on such matters before rendering a written decision thereon (by recommendation of an Application for Payment or otherwise). ENGINEER's written decision thereon will be final and binding (except as modified by ENGINEER to reflect changed factual conditions or more accurate data) upon OWNER and CONTRACTOR, subject to the provisions of paragraph 10.05.

#### 9.09 *Decisions on Requirements of Contract Documents and Acceptability of Work*

A. ENGINEER will be the initial interpreter of the requirements of the Contract Documents and judge of the acceptability of the Work thereunder. Claims, disputes and other matters relating to the acceptability of the Work, the quantities and classifications of Unit Price Work, the interpretation of the requirements of the Contract Documents pertaining to the performance of the Work, and Claims seeking changes in the Contract Price or Contract Times will be referred initially to ENGINEER in writing, in accordance with the provisions of paragraph 10.05, with a request for a formal decision.

B. When functioning as interpreter and judge under this paragraph 9.09, ENGINEER will not show partiality to OWNER or CONTRACTOR and will not be liable in connection with any interpretation or decision rendered in good faith in such capacity. The rendering of a decision by ENGINEER pursuant to this paragraph 9.09 with respect to any such Claim, dispute, or other matter (except any which have been waived by the making or acceptance of final payment as provided in paragraph 14.07) will be a condition precedent to any exercise by OWNER or CONTRACTOR of such rights or remedies as either may otherwise have under the Contract Documents or by Laws or Regulations in respect of any such Claim, dispute, or other matter.

\*See Supplementary Conditions

#### 9.10 *Limitations on ENGINEER's Authority and Responsibilities*

A. Neither ENGINEER's authority or responsibility under this Article 9 or under any other provision of the Contract Documents nor any decision made by ENGINEER in good faith either to exercise or not exercise such

authority or responsibility or the undertaking, exercise, or performance of any authority or responsibility by ENGINEER shall create, impose, or give rise to any duty in contract, tort, or otherwise owed by ENGINEER to CONTRACTOR, any Subcontractor, any Supplier, any other individual or entity, or to any surety for or employee or agent of any of them.

B. ENGINEER will not supervise, direct, control, or have authority over or be responsible for CONTRACTOR's means, methods, techniques, sequences, or procedures of construction, or the safety precautions and programs incident thereto, or for any failure of CONTRACTOR to comply with Laws and Regulations applicable to the performance of the Work. ENGINEER will not be responsible for CONTRACTOR's failure to perform the Work in accordance with the Contract Documents.

C. ENGINEER will not be responsible for the acts or omissions of CONTRACTOR or of any Subcontractor, any Supplier, or of any other individual or entity performing any of the Work.

D. ENGINEER's review of the final Application for Payment and accompanying documentation and all maintenance and operating instructions, schedules, guarantees, Bonds, certificates of inspection, tests and approvals, and other documentation required to be delivered by paragraph 14.07.A will only be to determine generally that their content complies with the requirements of, and in the case of certificates of inspections, tests, and approvals that the results certified indicate compliance with, the Contract Documents.

E. The limitations upon authority and responsibility set forth in this paragraph 9.10 shall also apply to ENGINEER's Consultants, Resident Project Representative, and assistants. See Article 18.

## ARTICLE 10 - CHANGES IN THE WORK; CLAIMS

---

### 10.01 *Authorized Changes in the Work*

A. Without invalidating the Agreement and without notice to any surety, OWNER may, at any time or from time to time, order additions, deletions, or revisions in the Work by a Written Amendment, a Change Order, or a Work Change Directive. Upon receipt of any such document, CONTRACTOR shall promptly proceed with the Work involved which will be performed under the

applicable conditions of the Contract Documents (except as otherwise specifically provided).

B. If OWNER and CONTRACTOR are unable to agree on entitlement to, or on the amount or extent, if any, of an adjustment in the Contract Price or Contract Times, or both, that should be allowed as a result of a Work Change Directive, a Claim may be made therefor as provided in paragraph 10.05.

### 10.02 *Unauthorized Changes in the Work*

A. CONTRACTOR shall not be entitled to an increase in the Contract Price or an extension of the Contract Times with respect to any work performed that is not required by the Contract Documents as amended, modified, or supplemented as provided in paragraph 3.04, except in the case of an emergency as provided in paragraph 6.16 or in the case of uncovering Work as provided in paragraph 13.04.B.

### 10.03 *Execution of Change Orders*

A. OWNER and CONTRACTOR shall execute appropriate Change Orders recommended by ENGINEER (or Written Amendments) covering:

1. changes in the Work which are: (i) ordered by OWNER pursuant to paragraph 10.01.A, (ii) required because of acceptance of defective Work under paragraph 13.08.A or OWNER's correction of defective Work under paragraph 13.09, or (iii) agreed to by the parties;

2. changes in the Contract Price or Contract Times which are agreed to by the parties, including any undisputed sum or amount of time for Work actually performed in accordance with a Work Change Directive; and

3. changes in the Contract Price or Contract Times which embody the substance of any written decision rendered by ENGINEER pursuant to paragraph 10.05; provided that, in lieu of executing any such Change Order, an appeal may be taken from any such decision in accordance with the provisions of the Contract Documents and applicable Laws and Regulations, but during any such appeal, CONTRACTOR shall carry on the Work and adhere to the progress schedule as provided in paragraph 6.18.A.

#### 10.04 *Notification to Surety*

A. If notice of any change affecting the general scope of the Work or the provisions of the Contract Documents (including, but not limited to, Contract Price or Contract Times) is required by the provisions of any Bond to be given to a surety, the giving of any such notice will be CONTRACTOR's responsibility. The amount of each applicable Bond will be adjusted to reflect the effect of any such change.

#### 10.05 *Claims and Disputes*

A. *Notice:* Written notice stating the general nature of each Claim, dispute, or other matter shall be delivered by the claimant to ENGINEER and the other party to the Contract promptly (but in no event later than 30 days) after the start of the event giving rise thereto. Notice of the amount or extent of the Claim, dispute, or other matter with supporting data shall be delivered to the ENGINEER and the other party to the Contract within 60 days after the start of such event (unless ENGINEER allows additional time for claimant to submit additional or more accurate data in support of such Claim, dispute, or other matter). A Claim for an adjustment in Contract Price shall be prepared in accordance with the provisions of paragraph 12.01.B. A Claim for an adjustment in Contract Time shall be prepared in accordance with the provisions of paragraph 12.02.B. Each Claim shall be accompanied by claimant's written statement that the adjustment claimed is the entire adjustment to which the claimant believes it is entitled as a result of said event. The opposing party shall submit any response to ENGINEER and the claimant within 30 days after receipt of the claimant's last submittal (unless ENGINEER allows additional time).

B. *ENGINEER's Decision:* ENGINEER will render a formal decision in writing within 30 days after receipt of the last submittal of the claimant or the last submittal of the opposing party, if any. ENGINEER's written decision on such Claim, dispute, or other matter will be final and binding upon OWNER and CONTRACTOR unless:

1. an appeal from ENGINEER's decision is taken within the time limits and in accordance with the dispute resolution procedures set forth in Article 16; or
2. if no such dispute resolution procedures have been set forth in Article 16, a written notice of intention to appeal from ENGINEER's written decision is delivered by OWNER or CONTRACTOR to the other and to ENGINEER within 30 days

after the date of such decision, and a formal proceeding is instituted by the appealing party in a forum of competent jurisdiction within 60 days after the date of such decision or within 60 days after Substantial Completion, whichever is later (unless otherwise agreed in writing by OWNER and CONTRACTOR), to exercise such rights or remedies as the appealing party may have with respect to such Claim, dispute, or other matter in accordance with applicable Laws and Regulations.

C. If ENGINEER does not render a formal decision in writing within the time stated in paragraph 10.05.B, a decision denying the Claim in its entirety shall be deemed to have been issued 31 days after receipt of the last submittal of the claimant or the last submittal of the opposing party, if any.

D. No Claim for an adjustment in Contract Price or Contract Times (or Milestones) will be valid if not submitted in accordance with this paragraph 10.05.

#### ARTICLE 11 - COST OF THE WORK; CASH ALLOWANCES; UNIT PRICE WORK

---

##### 11.01 *Cost of the Work*

A. *Costs Included:* The term Cost of the Work means the sum of all costs necessarily incurred and paid by CONTRACTOR in the proper performance of the Work. When the value of any Work covered by a Change Order or when a Claim for an adjustment in Contract Price is determined on the basis of Cost of the Work, the costs to be reimbursed to CONTRACTOR will be only those additional or incremental costs required because of the change in the Work or because of the event giving rise to the Claim. Except as otherwise may be agreed to in writing by OWNER, such costs shall be in amounts no higher than those prevailing in the locality of the Project, shall include only the following items, and shall not include any of the costs itemized in paragraph 11.01.B.

1. Payroll costs for employees in the direct employ of CONTRACTOR in the performance of the Work under schedules of job classifications agreed upon by OWNER and CONTRACTOR. Such employees shall include without limitation superintendents, foremen, and other personnel employed full time at the Site. Payroll costs for employees not employed full time on the Work

shall be apportioned on the basis of their time spent on the Work. Payroll costs shall include, but not be limited to, salaries and wages plus the cost of fringe benefits, which shall include social security contributions, unemployment, excise, and payroll taxes, workers' compensation, health and retirement benefits, bonuses, sick leave, vacation and holiday pay applicable thereto. The expenses of performing Work outside of regular working hours, on Saturday, Sunday, or legal holidays, shall be included in the above to the extent authorized by OWNER.

2. Cost of all materials and equipment furnished and incorporated in the Work, including costs of transportation and storage thereof, and Suppliers' field services required in connection therewith. All cash discounts shall accrue to CONTRACTOR unless OWNER deposits funds with CONTRACTOR with which to make payments, in which case the cash discounts shall accrue to OWNER. All trade discounts, rebates and refunds and returns from sale of surplus materials and equipment shall accrue to OWNER, and CONTRACTOR shall make provisions so that they may be obtained.

3. Payments made by CONTRACTOR to Subcontractors for Work performed by Subcontractors. If required by OWNER, CONTRACTOR shall obtain competitive bids from subcontractors acceptable to OWNER and CONTRACTOR and shall deliver such bids to OWNER, who will then determine, with the advice of ENGINEER, which bids, if any, will be acceptable. If any subcontract provides that the Subcontractor is to be paid on the basis of Cost of the Work plus a fee, the Subcontractor's Cost of the Work and fee shall be determined in the same manner as CONTRACTOR's Cost of the Work and fee as provided in this paragraph 11.01.

4. Costs of special consultants (including but not limited to engineers, architects, testing laboratories, surveyors, attorneys, and accountants) employed for services specifically related to the Work.

5. Supplemental costs including the following:

a. The proportion of necessary transportation, travel, and subsistence expenses of

CONTRACTOR's employees incurred in discharge of duties connected with the Work.

b. Cost, including transportation and maintenance, of all materials, supplies, equipment, machinery, appliances, office, and temporary facilities at the Site, and hand tools not owned by the workers, which are consumed in the performance of the Work, and cost, less market value, of such items used but not consumed which remain the property of CONTRACTOR.

c. Rentals of all construction equipment and machinery, and the parts thereof whether rented from CONTRACTOR or others in accordance with rental agreements approved by OWNER with the advice of ENGINEER, and the costs of transportation, loading, unloading, assembly, dismantling, and removal thereof. All such costs shall be in accordance with the terms of said rental agreements. The rental of any such equipment, machinery, or parts shall cease when the use thereof is no longer necessary for the Work.

d. Sales, consumer, use, and other similar taxes related to the Work, and for which CONTRACTOR is liable, imposed by Laws and Regulations.

e. Deposits lost for causes other than negligence of CONTRACTOR, any Subcontractor, or anyone directly or indirectly employed by any of them or for whose acts any of them may be liable, and royalty payments and fees for permits and licenses.

f. Losses and damages (and related expenses) caused by damage to the Work, not compensated by insurance or otherwise, sustained by CONTRACTOR in connection with the performance of the Work (except losses and damages within the deductible amounts of property insurance established in accordance with paragraph 5.06.D), provided such losses and damages have resulted from causes other than the negligence of CONTRACTOR, any Subcontractor, or anyone directly or indirectly employed by any of them or for whose acts any of them may be liable. Such losses shall include settlements made with the written consent and approval of OWNER. No such losses, damages, and expenses shall be included in the Cost of the Work for the purpose of determining CONTRACTOR's fee.

g. The cost of utilities, fuel, and sanitary facilities at the Site.

h. Minor expenses such as telegrams, long distance telephone calls, telephone service at the Site, expressage, and similar petty cash items in connection with the Work.

i. When the Cost of the Work is used to determine the value of a Change Order or of a Claim, the cost of premiums for additional Bonds and insurance required because of the changes in the Work or caused by the event giving rise to the Claim.

j. When all the Work is performed on the basis of cost-plus, the costs of premiums for all Bonds and insurance CONTRACTOR is required by the Contract Documents to purchase and maintain.

B. *Costs Excluded:* The term Cost of the Work shall not include any of the following items:

1. Payroll costs and other compensation of CONTRACTOR's officers, executives, principals (of partnerships and sole proprietorships), general managers, engineers, architects, estimators, attorneys, auditors, accountants, purchasing and contracting agents, expeditors, timekeepers, clerks, and other personnel employed by CONTRACTOR, whether at the Site or in CONTRACTOR's principal or branch office for general administration of the Work and not specifically included in the agreed upon schedule of job classifications referred to in paragraph 11.01.A.1 or specifically covered by paragraph 11.01.A.4, all of which are to be considered administrative costs covered by the CONTRACTOR's fee.

2. Expenses of CONTRACTOR's principal and branch offices other than CONTRACTOR's office at the Site.

3. Any part of CONTRACTOR's capital expenses, including interest on CONTRACTOR's capital employed for the Work and charges against CONTRACTOR for delinquent payments.

4. Costs due to the negligence of CONTRACTOR, any Subcontractor, or anyone directly or indirectly employed by any of them or for whose acts any of them may be liable, including but not

limited to, the correction of defective Work, disposal of materials or equipment wrongly supplied, and making good any damage to property.

5. Other overhead or general expense costs of any kind and the costs of any item not specifically and expressly included in paragraphs 11.01.A and 11.01.B.

C. *CONTRACTOR's Fee:* When all the Work is performed on the basis of cost-plus, CONTRACTOR's fee shall be determined as set forth in the Agreement. When the value of any Work covered by a Change Order or when a Claim for an adjustment in Contract Price is determined on the basis of Cost of the Work, CONTRACTOR's fee shall be determined as set forth in paragraph 12.01.C.

D. *Documentation:* Whenever the Cost of the Work for any purpose is to be determined pursuant to paragraphs 11.01.A and 11.01.B, CONTRACTOR will establish and maintain records thereof in accordance with generally accepted accounting practices and submit in a form acceptable to ENGINEER an itemized cost breakdown together with supporting data.

#### 11.02 *Cash Allowances*

A. It is understood that CONTRACTOR has included in the Contract Price all allowances so named in the Contract Documents and shall cause the Work so covered to be performed for such sums as may be acceptable to OWNER and ENGINEER. CONTRACTOR agrees that:

1. the allowances include the cost to CONTRACTOR (less any applicable trade discounts) of materials and equipment required by the allowances to be delivered at the Site, and all applicable taxes; and

2. CONTRACTOR's costs for unloading and handling on the Site, labor, installation costs, overhead, profit, and other expenses contemplated for the allowances have been included in the Contract Price and not in the allowances, and no demand for additional payment on account of any of the foregoing will be valid.

B. Prior to final payment, an appropriate Change Order will be issued as recommended by ENGINEER to reflect actual amounts due CONTRACTOR on account of

Work covered by allowances, and the Contract Price shall be correspondingly adjusted.

11.03 *Unit Price Work*

A. Where the Contract Documents provide that all or part of the Work is to be Unit Price Work, initially the Contract Price will be deemed to include for all Unit Price Work an amount equal to the sum of the unit price for each separately identified item of Unit Price Work times the estimated quantity of each item as indicated in the Agreement. The estimated quantities of items of Unit Price Work are not guaranteed and are solely for the purpose of comparison of Bids and determining an initial Contract Price. Determinations of the actual quantities and classifications of Unit Price Work performed by CONTRACTOR will be made by ENGINEER subject to the provisions of paragraph 9.08.

B. Each unit price will be deemed to include an amount considered by CONTRACTOR to be adequate to cover CONTRACTOR's overhead and profit for each separately identified item.

C. OWNER or CONTRACTOR may make a Claim for an adjustment in the Contract Price in accordance with paragraph 10.05 if:

1. the quantity of any item of Unit Price Work performed by CONTRACTOR differs materially and significantly from the estimated quantity of such item indicated in the Agreement; and
2. there is no corresponding adjustment with respect any other item of Work; and
3. if CONTRACTOR believes that CONTRACTOR is entitled to an increase in Contract Price as a result of having incurred additional expense or OWNER believes that OWNER is entitled to a decrease in Contract Price and the parties are unable to agree as to the amount of any such increase or decrease.

ARTICLE 12 - CHANGE OF CONTRACT PRICE;  
CHANGE OF CONTRACT TIMES

---

12.01\* *Change of Contract Price*

A. The Contract Price may only be changed by a Change Order or by a Written Amendment. Any Claim for an adjustment in the Contract Price shall be based on written notice submitted by the party making the Claim to the ENGINEER and the other party to the Contract in accordance with the provisions of paragraph 10.05.

B.\* The value of any Work covered by a Change Order or of any Claim for an adjustment in the Contract Price will be determined as follows:

1. where the Work involved is covered by unit prices contained in the Contract Documents, by application of such unit prices to the quantities of the items involved (subject to the provisions of paragraph 11.03 ); or

2. where the Work involved is not covered by unit prices contained in the Contract Documents, by a mutually agreed lump sum (which may include an allowance for overhead and profit not necessarily in accordance with paragraph 12.01.C.2); or

3. where the Work involved is not covered by unit prices contained in the Contract Documents and agreement to a lump sum is not reached under paragraph 12.01.B.2, on the basis of the Cost of the Work (determined as provided in paragraph 11.01) plus a CONTRACTOR's fee for overhead and profit (determined as provided in paragraph 12.01.C).

C. *CONTRACTOR's Fee*: The CONTRACTOR's fee for overhead and profit shall be determined as follows:

1. a mutually acceptable fixed fee; or
2. if a fixed fee is not agreed upon, then a fee based on the following percentages of the various portions of the Cost of the Work:
  - a. for costs incurred under paragraphs 11.01.A.1 and 11.01.A.2, the CONTRACTOR's fee shall be 15 percent;

b. for costs incurred under paragraph 11.01.A.3, the CONTRACTOR's fee shall be five percent;

c. where one or more tiers of subcontracts are on the basis of Cost of the Work plus a fee and no fixed fee is agreed upon, the intent of paragraph 12.01.C.2.a is that the Subcontractor who actually performs the Work, at whatever tier, will be paid a fee of 15 percent of the costs incurred by such Subcontractor under paragraphs 11.01.A.1 and 11.01.A.2 and that any higher tier Subcontractor and CONTRACTOR will each be paid a fee of five percent of the amount paid to the next lower tier Subcontractor;

\*See Supplementary Conditions

d. no fee shall be payable on the basis of costs itemized under paragraphs 11.01.A.4, 11.01.A.5, and 11.01.B;

e. the amount of credit to be allowed by CONTRACTOR to OWNER for any change which results in a net decrease in cost will be the amount of the actual net decrease in cost plus a deduction in CONTRACTOR's fee by an amount equal to five percent of such net decrease; and

f. when both additions and credits are involved in any one change, the adjustment in CONTRACTOR's fee shall be computed on the basis of the net change in accordance with paragraphs 12.01.C.2.a through 12.01.C.2.e, inclusive.

#### 12.02 *Change of Contract Times*

A. The Contract Times (or Milestones) may only be changed by a Change Order or by a Written Amendment. Any Claim for an adjustment in the Contract Times (or Milestones) shall be based on written notice submitted by the party making the claim to the ENGINEER and the other party to the Contract in accordance with the provisions of paragraph 10.05.

B. Any adjustment of the Contract Times (or Milestones) covered by a Change Order or of any Claim for an adjustment in the Contract Times (or Milestones)

will be determined in accordance with the provisions of this Article 12.

#### 12.03 *Delays Beyond CONTRACTOR's Control*

A. Where CONTRACTOR is prevented from completing any part of the Work within the Contract Times (or Milestones) due to delay beyond the control of CONTRACTOR, the Contract Times (or Milestones) will be extended in an amount equal to the time lost due to such delay if a Claim is made therefor as provided in paragraph 12.02.A. Delays beyond the control of CONTRACTOR shall include, but not be limited to, acts or neglect by OWNER, acts or neglect of utility owners or other contractors performing other work as contemplated by Article 7, fires, floods, epidemics, abnormal weather conditions, or acts of God.

#### 12.04 *Delays Within CONTRACTOR's Control*

A. The Contract Times (or Milestones) will not be extended due to delays within the control of CONTRACTOR. Delays attributable to and within the control of a Subcontractor or Supplier shall be deemed to be delays within the control of CONTRACTOR.

#### 12.05 *Delays Beyond OWNER's and CONTRACTOR's Control*

A. Where CONTRACTOR is prevented from completing any part of the Work within the Contract Times (or Milestones) due to delay beyond the control of both OWNER and CONTRACTOR, an extension of the Contract Times (or Milestones) in an amount equal to the time lost due to such delay shall be CONTRACTOR's sole and exclusive remedy for such delay.

#### 12.06 *Delay Damages*

A. In no event shall OWNER or ENGINEER be liable to CONTRACTOR, any Subcontractor, any Supplier, or any other person or organization, or to any surety for or employee or agent of any of them, for damages arising out of or resulting from:

1. delays caused by or within the control of CONTRACTOR; or

2. delays beyond the control of both OWNER and CONTRACTOR including but not limited to fires, floods, epidemics, abnormal weather conditions, acts of God, or acts or neglect by utility

owners or other contractors performing other work as contemplated by Article 7.

B. Nothing in this paragraph 12.06 bars a change in Contract Price pursuant to this Article 12 to compensate CONTRACTOR due to delay, interference, or disruption directly attributable to actions or inactions of OWNER or anyone for whom OWNER is responsible.

ARTICLE 13 - TESTS AND INSPECTIONS;  
CORRECTION, REMOVAL OR ACCEPTANCE OF  
DEFECTIVE WORK

---

13.01 *Notice of Defects*

A. Prompt notice of all defective Work of which OWNER or ENGINEER has actual knowledge will be given to CONTRACTOR. All defective Work may be rejected, corrected, or accepted as provided in this Article 13.

13.02\* *Access to Work*

A. OWNER, ENGINEER, ENGINEER's Consultants, other representatives and personnel of OWNER, independent testing laboratories, and governmental agencies with jurisdictional interests will have access to the Site and the Work at reasonable times for their observation, inspecting, and testing. CONTRACTOR shall provide them proper and safe conditions for such access and advise them of CONTRACTOR's Site safety procedures and programs so that they may comply therewith as applicable.

13.03\* *Tests and Inspections*

A. CONTRACTOR shall give ENGINEER timely notice of readiness of the Work for all required inspections, tests, or approvals and shall cooperate with inspection and testing personnel to facilitate required inspections or tests.

B.\* OWNER shall employ and pay for the services of an independent testing laboratory to perform all inspections, tests, or approvals required by the Contract Documents except:

1. for inspections, tests, or approvals covered by paragraphs 13.03.C and 13.03.D below;

2. that costs incurred in connection with tests or inspections conducted pursuant to paragraph 13.04.B shall be paid as provided in said paragraph 13.04.B; and

3. as otherwise specifically provided in the Contract Documents.

C. If Laws or Regulations of any public body having jurisdiction require any Work (or part thereof) specifically to be inspected, tested, or approved by an employee or other representative of such public body, CONTRACTOR shall assume full responsibility for arranging and obtaining such inspections, tests, or approvals, pay all costs in connection therewith, and furnish ENGINEER the required certificates of inspection or approval.

D. CONTRACTOR shall be responsible for arranging and obtaining and shall pay all costs in connection with any inspections, tests, or approvals required for OWNER's and ENGINEER's acceptance of materials or equipment to be incorporated in the Work; or acceptance of materials, mix designs, or equipment submitted for approval prior to CONTRACTOR's purchase thereof for incorporation in the Work. Such inspections, tests, or approvals shall be performed by organizations acceptable to OWNER and ENGINEER.

E. If any Work (or the work of others) that is to be inspected, tested, or approved is covered by CONTRACTOR without written concurrence of ENGINEER, it must, if requested by ENGINEER, be uncovered for observation.

F. Uncovering Work as provided in paragraph 13.03.E shall be at CONTRACTOR's expense unless CONTRACTOR has given ENGINEER timely notice of CONTRACTOR's intention to cover the same and ENGINEER has not acted with reasonable promptness in response to such notice.

13.04 *Uncovering Work*

A. If any Work is covered contrary to the written request of ENGINEER, it must, if requested by ENGINEER, be uncovered for ENGINEER's observation and replaced at CONTRACTOR's expense.

B. If ENGINEER considers it necessary or advisable that covered Work be observed by ENGINEER or inspected or tested by others, CONTRACTOR, at ENGINEER's request, shall uncover, expose, or otherwise make available for observation, inspection, or testing as ENGINEER may require, that portion of the Work in

question, furnishing all necessary labor, material, and equipment. If it is found that such Work is defective, CONTRACTOR shall pay all Claims, costs, losses, and damages (including but not limited to all fees and charges of engineers, architects, attorneys, and other professionals and all court or arbitration or other dispute resolution costs) arising out of or relating to such uncovering, exposure, observation, inspection, and testing, and of satisfactory replacement or reconstruction (including but not limited to all costs of repair or replacement of work of others); and OWNER shall be entitled to an appropriate decrease in the Contract Price. If the parties are unable to agree as to the amount thereof, OWNER may make a Claim therefor as provided in paragraph 10.05. If, however, such Work is not found to be defective, CONTRACTOR shall be allowed an increase in the Contract Price or an extension of the Contract Times (or Milestones), or both, directly attributable to such uncovering, exposure, observation, inspection, testing, replacement, and reconstruction. If the parties are unable to agree as to the amount or extent thereof, CONTRACTOR may make a Claim therefor as provided in paragraph 10.05.

\*See Supplementary Conditions

#### 13.05 *OWNER May Stop the Work*

A. If the Work is defective, or CONTRACTOR fails to supply sufficient skilled workers or suitable materials or equipment, or fails to perform the Work in such a way that the completed Work will conform to the Contract Documents, OWNER may order CONTRACTOR to stop the Work, or any portion thereof, until the cause for such order has been eliminated; however, this right of OWNER to stop the Work shall not give rise to any duty on the part of OWNER to exercise this right for the benefit of CONTRACTOR, any Subcontractor, any Supplier, any other individual or entity, or any surety for, or employee or agent of any of them.

#### 13.06 *Correction or Removal of Defective Work*

A. CONTRACTOR shall correct all defective Work, whether or not fabricated, installed, or completed, or, if the Work has been rejected by ENGINEER, remove it from the Project and replace it with Work that is not defective. CONTRACTOR shall pay all Claims, costs, losses, and damages (including but not limited to all fees and charges of engineers, architects, attorneys, and other professionals and all court or arbitration or other dispute resolution costs) arising out of or relating to such correction or removal (including but not limited to all costs of repair or replacement of work of others).

#### 13.07 *Correction Period*

A. If within one year after the date of Substantial Completion or such longer period of time as may be prescribed by Laws or Regulations or by the terms of any applicable special guarantee required by the Contract Documents or by any specific provision of the Contract Documents, any Work is found to be defective, or if the repair of any damages to the land or areas made available for CONTRACTOR's use by OWNER or permitted by Laws and Regulations as contemplated in paragraph 6.11.A is found to be defective, CONTRACTOR shall promptly, without cost to OWNER and in accordance with OWNER's written instructions: (i) repair such defective land or areas, or (ii) correct such defective Work or, if the defective Work has been rejected by OWNER, remove it from the Project and replace it with Work that is not defective, and (iii) satisfactorily correct or repair or remove and replace any damage to other Work, to the work of others or other land or areas resulting therefrom. If CONTRACTOR does not promptly comply with the terms of such instructions, or in an emergency where delay would cause serious risk of loss or damage, OWNER may have the defective Work corrected or repaired or may have the rejected Work removed and replaced, and all Claims, costs, losses, and damages (including but not limited to all fees and charges of engineers, architects, attorneys, and other professionals and all court or arbitration or other dispute resolution costs) arising out of or relating to such correction or repair or such removal and replacement (including but not limited to all costs of repair or replacement of work of others) will be paid by CONTRACTOR.

B. In special circumstances where a particular item of equipment is placed in continuous service before Substantial Completion of all the Work, the correction period for that item may start to run from an earlier date if so provided in the Specifications or by Written Amendment.

C. Where defective Work (and damage to other Work resulting therefrom) has been corrected or removed and replaced under this paragraph 13.07, the correction period hereunder with respect to such Work will be extended for an additional period of one year after such correction or removal and replacement has been satisfactorily completed.

D. CONTRACTOR's obligations under this paragraph 13.07 are in addition to any other obligation or warranty. The provisions of this paragraph 13.07 shall not be construed as a substitute for or a waiver of the provisions of any applicable statute of limitation or repose.

#### 13.08 *Acceptance of Defective Work*

A. If, instead of requiring correction or removal and replacement of defective Work, OWNER (and, prior to ENGINEER's recommendation of final payment, ENGINEER) prefers to accept it, OWNER may do so. CONTRACTOR shall pay all Claims, costs, losses, and damages (including but not limited to all fees and charges of engineers, architects, attorneys, and other professionals and all court or arbitration or other dispute resolution costs) attributable to OWNER's evaluation of and determination to accept such defective Work (such costs to be approved by ENGINEER as to reasonableness) and the diminished value of the Work to the extent not otherwise paid by CONTRACTOR pursuant to this sentence. If any such acceptance occurs prior to ENGINEER's recommendation of final payment, a Change Order will be issued incorporating the necessary revisions in the Contract Documents with respect to the Work, and OWNER shall be entitled to an appropriate decrease in the Contract Price, reflecting the diminished value of Work so accepted. If the parties are unable to agree as to the amount thereof, OWNER may make a Claim therefor as provided in paragraph 10.05. If the acceptance occurs after such recommendation, an appropriate amount will be paid by CONTRACTOR to OWNER.

#### 13.09 *OWNER May Correct Defective Work*

A. If CONTRACTOR fails within a reasonable time after written notice from ENGINEER to correct defective Work or to remove and replace rejected Work as required by ENGINEER in accordance with paragraph 13.06.A, or if CONTRACTOR fails to perform the Work in accordance with the Contract Documents, or if CONTRACTOR fails to comply with any other provision of the Contract Documents, OWNER may, after seven days written notice

to CONTRACTOR, correct and remedy any such deficiency.

B. In exercising the rights and remedies under this paragraph, OWNER shall proceed expeditiously. In connection with such corrective and remedial action, OWNER may exclude CONTRACTOR from all or part of the Site, take possession of all or part of the Work and suspend CONTRACTOR's services related thereto, take possession of CONTRACTOR's tools, appliances, construction equipment and machinery at the Site, and incorporate in the Work all materials and equipment stored at the Site or for which OWNER has paid CONTRACTOR but which are stored elsewhere. CONTRACTOR shall allow OWNER, OWNER's representatives, agents and employees, OWNER's other contractors, and ENGINEER and ENGINEER's Consultants access to the Site to enable OWNER to exercise the rights and remedies under this paragraph.

C. All Claims, costs, losses, and damages (including but not limited to all fees and charges of engineers, architects, attorneys, and other professionals and all court or arbitration or other dispute resolution costs) incurred or sustained by OWNER in exercising the rights and remedies under this paragraph 13.09 will be charged against CONTRACTOR, and a Change Order will be issued incorporating the necessary revisions in the Contract Documents with respect to the Work; and OWNER shall be entitled to an appropriate decrease in the Contract Price. If the parties are unable to agree as to the amount of the adjustment, OWNER may make a Claim therefor as provided in paragraph 10.05. Such claims, costs, losses and damages will include but not be limited to all costs of repair, or replacement of work of others destroyed or damaged by correction, removal, or replacement of CONTRACTOR's defective Work.

D. CONTRACTOR shall not be allowed an extension of the Contract Times (or Milestones) because of any delay in the performance of the Work attributable to the exercise by OWNER of OWNER's rights and remedies under this paragraph 13.09.

ARTICLE 14 - PAYMENTS TO CONTRACTOR AND COMPLETION

---

14.01 *Schedule of Values*

A. The schedule of values established as provided in paragraph 2.07.A will serve as the basis for progress payments and will be incorporated into a form of Application for Payment acceptable to ENGINEER. Progress payments on account of Unit Price Work will be based on the number of units completed.

14.02 *Progress Payments*

A.\* *Applications for Payments*

1. At least 20 days before the date established for each progress payment (but not more often than once a month), CONTRACTOR shall submit to ENGINEER for review an Application for Payment filled out and signed by CONTRACTOR covering the Work completed as of the date of the Application and accompanied by such supporting documentation as is required by the Contract Documents. If payment is requested on the basis of materials and equipment not incorporated in the Work but delivered and suitably stored at the Site or at another location agreed to in writing, the Application for Payment shall also be accompanied by a bill of sale, invoice, or other documentation warranting that OWNER has received the materials and equipment free and clear of all Liens and evidence that the materials and equipment are covered by appropriate property insurance or other arrangements to protect OWNER's interest therein, all of which must be satisfactory to OWNER.

2. Beginning with the second Application for Payment, each Application shall include an affidavit of CONTRACTOR stating that all previous progress payments received on account of the Work have been applied on account to discharge CONTRACTOR's legitimate obligations associated with prior Applications for Payment.

3. The amount of retainage with respect to pro-gress payments will be as stipulated in the Agreement.

\*See Supplementary Conditions

B. *Review of Applications*

1. ENGINEER will, within 10 days after receipt of each Application for Payment, either indicate in writing a recommendation of payment and present the Application to OWNER or return the Application to CONTRACTOR indicating in writing ENGINEER's reasons for refusing to recommend payment. In the latter case, CONTRACTOR may make the necessary corrections and resubmit the Application.

2. ENGINEER's recommendation of any payment requested in an Application for Payment will constitute a representation by ENGINEER to OWNER, based on ENGINEER's observations on the Site of the executed Work as an experienced and qualified design professional and on ENGINEER's review of the Application for Payment and the accompanying data and schedules, that to the best of ENGINEER's knowledge, information and belief:

a. the Work has progressed to the point indicated;

b. the quality of the Work is generally in accordance with the Contract Documents (subject to an evaluation of the Work as a functioning whole prior to or upon Substantial Completion, to the results of any subsequent tests called for in the Contract Documents, to a final determination of quantities and classifications for Unit Price Work under paragraph 9.08, and to any other qualifications stated in the recommendation); and

c. the conditions precedent to CONTRACTOR's being entitled to such payment appear to have been fulfilled in so far as it is ENGINEER's responsibility to observe the Work.

3. By recommending any such payment ENGINEER will not thereby be deemed to have represented that: (i) inspections made to check the quality or the quantity of the Work as it has been performed have been exhaustive, extended to every aspect of the Work in progress, or involved detailed inspections of the Work beyond the responsibilities specifically assigned to ENGINEER in the Contract Documents; or (ii) that there may not be other matters or issues between the parties

that might entitle CONTRACTOR to be paid additionally by OWNER or entitle OWNER to withhold payment to CONTRACTOR.

4. Neither ENGINEER's review of CONTRACTOR's Work for the purposes of recommending payments nor ENGINEER's recommendation of any payment, including final payment, will impose responsibility on ENGINEER to supervise, direct, or control the Work or for the means, methods, techniques, sequences, or procedures of construction, or the safety precautions and programs incident thereto, or for CONTRACTOR's failure to comply with Laws and Regulations applicable to CONTRACTOR's performance of the Work. Additionally, said review or recommendation will not impose responsibility on ENGINEER to make any examination to ascertain how or for what purposes CONTRACTOR has used the moneys paid on account of the Contract Price, or to determine that title to any of the Work, materials, or equipment has passed to OWNER free and clear of any Liens.

5. ENGINEER may refuse to recommend the whole or any part of any payment if, in ENGINEER's opinion, it would be incorrect to make the representations to OWNER referred to in paragraph 14.02.B.2. ENGINEER may also refuse to recommend any such payment or, because of subsequently discovered evidence or the results of subsequent inspections or tests, revise or revoke any such payment recommendation previously made, to such extent as may be necessary in ENGINEER's opinion to protect OWNER from loss because:

a. the Work is defective, or completed Work has been damaged, requiring correction or replacement;

b. the Contract Price has been reduced by Written Amendment or Change Orders;

c. OWNER has been required to correct defective Work or complete Work in accordance with paragraph 13.09; or

d. ENGINEER has actual knowledge of the occurrence of any of the events enumerated in paragraph 15.02.A.

#### C. *Payment Becomes Due*

1. Ten days after presentation of the Application for Payment to OWNER with ENGINEER's recommendation, the amount recommended will (subject to the provisions of paragraph 14.02.D) become due, and when due will be paid by OWNER to CONTRACTOR.

#### D. *Reduction in Payment*

1. OWNER may refuse to make payment of the full amount recommended by ENGINEER because:

a. claims have been made against OWNER on account of CONTRACTOR's performance or furnishing of the Work;

b. Liens have been filed in connection with the Work, except where CONTRACTOR has delivered a specific Bond satisfactory to OWNER to secure the satisfaction and discharge of such Liens;

c. there are other items entitling OWNER to a set-off against the amount recommended; or

d. OWNER has actual knowledge of the occurrence of any of the events enumerated in paragraphs 14.02.B.5.a through 14.02.B.5.c or paragraph 15.02.A.

2. If OWNER refuses to make payment of the full amount recommended by ENGINEER, OWNER must give CONTRACTOR immediate written notice (with a copy to ENGINEER) stating the reasons for such action and promptly pay CONTRACTOR any amount remaining after deduction of the amount so withheld. OWNER shall promptly pay CONTRACTOR the amount so withheld, or any adjustment thereto agreed to by OWNER and CONTRACTOR, when CONTRACTOR corrects to OWNER's satisfaction the reasons for such action.

3. If it is subsequently determined that OWNER's refusal of payment was not justified, the amount wrongfully withheld shall be treated as an amount due as determined by paragraph 14.02.C.1.

#### 14.03 *CONTRACTOR's Warranty of Title*

A. CONTRACTOR warrants and guarantees that title to all Work, materials, and equipment covered by any Application for Payment, whether incorporated in the Project or not, will pass to OWNER no later than the time of payment free and clear of all Liens.

#### 14.04 *Substantial Completion*

A. When CONTRACTOR considers the entire Work ready for its intended use CONTRACTOR shall notify OWNER and ENGINEER in writing that the entire Work is substantially complete (except for items specifically listed by CONTRACTOR as incomplete) and request that ENGINEER issue a certificate of Substantial Completion. Promptly thereafter, OWNER, CONTRACTOR, and ENGINEER shall make an inspection of the Work to determine the status of completion. If ENGINEER does not consider the Work substantially complete, ENGINEER will notify CONTRACTOR in writing giving the reasons therefor. If ENGINEER considers the Work substantially complete, ENGINEER will prepare and deliver to OWNER a tentative certificate of Substantial Completion which shall fix the date of Substantial Completion. There shall be attached to the certificate a tentative list of items to be completed or corrected before final payment. OWNER shall have seven days after receipt of the tentative certificate during which to make written objection to ENGINEER as to any provisions of the certificate or attached list. If, after considering such objections, ENGINEER concludes that the Work is not substantially complete, ENGINEER will within 14 days after submission of the tentative certificate to OWNER notify CONTRACTOR in writing, stating the reasons therefor. If, after consideration of OWNER's objections, ENGINEER considers the Work substantially complete, ENGINEER will within said 14 days execute and deliver to OWNER and CONTRACTOR a definitive certificate of Substantial Completion (with a revised tentative list of items to be completed or corrected) reflecting such changes from the tentative certificate as ENGINEER believes justified after consideration of any objections from OWNER. At the time of delivery of the tentative certificate of Substantial Completion ENGINEER will deliver to OWNER and CONTRACTOR a written recommendation as to division of responsibilities pending final payment between OWNER and CONTRACTOR with respect to security, operation, safety, and protection of the Work, maintenance, heat, utilities, insurance, and warranties and guarantees. Unless OWNER and CONTRACTOR agree otherwise in writing and so inform ENGINEER in writing prior to ENGINEER's issuing the definitive certificate of Substantial Completion,

ENGINEER's aforesaid recommendation will be binding on OWNER and CONTRACTOR until final payment.

B. OWNER shall have the right to exclude CONTRACTOR from the Site after the date of Substantial Completion, but OWNER shall allow CONTRACTOR reasonable access to complete or correct items on the tentative list.

#### 14.05 *Partial Utilization*

A. Use by OWNER at OWNER's option of any substantially completed part of the Work which has specifically been identified in the Contract Documents, or which OWNER, ENGINEER, and CONTRACTOR agree constitutes a separately functioning and usable part of the Work that can be used by OWNER for its intended purpose without significant interference with CONTRACTOR's performance of the remainder of the Work, may be accomplished prior to Substantial Completion of all the Work subject to the following conditions.

1. OWNER at any time may request CONTRACTOR in writing to permit OWNER to use any such part of the Work which OWNER believes to be ready for its intended use and substantially complete. If CONTRACTOR agrees that such part of the Work is substantially complete, CONTRACTOR will certify to OWNER and ENGINEER that such part of the Work is substantially complete and request ENGINEER to issue a certificate of Substantial Completion for that part of the Work. CONTRACTOR at any time may notify OWNER and ENGINEER in writing that CONTRACTOR considers any such part of the Work ready for its intended use and substantially complete and request ENGINEER to issue a certificate of Substantial Completion for that part of the Work. Within a reasonable time after either such request, OWNER, CONTRACTOR, and ENGINEER shall make an inspection of that part of the Work to determine its status of completion. If ENGINEER does not consider that part of the Work to be substantially complete, ENGINEER will notify OWNER and CONTRACTOR in writing giving the reasons therefor. If ENGINEER considers that part of the Work to be substantially complete, the provisions of paragraph 14.04 will apply with respect to certification of Substantial Completion of that part of the Work and the division of responsibility in respect thereof and access thereto.

2. No occupancy or separate operation of part of the Work may occur prior to compliance with the requirements of paragraph 5.10 regarding property insurance.

#### 14.06 *Final Inspection*

A. Upon written notice from CONTRACTOR that the entire Work or an agreed portion thereof is complete, ENGINEER will promptly make a final inspection with OWNER and CONTRACTOR and will notify CONTRACTOR in writing of all particulars in which this inspection reveals that the Work is incomplete or defective. CONTRACTOR shall immediately take such measures as are necessary to complete such Work or remedy such deficiencies.

#### 14.07 *Final Payment*

##### A. *Application for Payment*

1. After CONTRACTOR has, in the opinion of ENGINEER, satisfactorily completed all corrections identified during the final inspection and has delivered, in accordance with the Contract Documents, all maintenance and operating instructions, schedules, guarantees, Bonds, certificates or other evidence of insurance certificates of inspection, marked-up record documents (as provided in paragraph 6.12), and other documents, CONTRACTOR may make application for final payment following the procedure for progress payments.

2. The final Application for Payment shall be accompanied (except as previously delivered) by: (i) all documentation called for in the Contract Documents, including but not limited to the evidence of insurance required by subparagraph 5.04.B.7; (ii) consent of the surety, if any, to final payment; and (iii) complete and legally effective releases or waivers (satisfactory to OWNER) of all Lien rights arising out of or Liens filed in connection with the Work.

3. In lieu of the releases or waivers of Liens specified in paragraph 14.07.A.2 and as approved by OWNER, CONTRACTOR may furnish receipts or releases in full and an affidavit of CONTRACTOR that: (i) the releases and receipts include all labor, services, material, and equipment for which a Lien could be filed; and (ii) all payrolls, material and equipment bills, and other

indebtedness connected with the Work for which OWNER or OWNER's property might in any way be responsible have been paid or otherwise satisfied. If any Subcontractor or Supplier fails to furnish such a release or receipt in full, CONTRACTOR may furnish a Bond or other collateral satisfactory to OWNER to indemnify OWNER against any Lien.

##### B. *Review of Application and Acceptance*

1. If, on the basis of ENGINEER's observation of the Work during construction and final inspection, and ENGINEER's review of the final Application for Payment and accompanying documentation as required by the Contract Documents, ENGINEER is satisfied that the Work has been completed and CONTRACTOR's other obligations under the Contract Documents have been fulfilled, ENGINEER will, within ten days after receipt of the final Application for Payment, indicate in writing ENGINEER's recommendation of payment and present the Application for Payment to OWNER for payment. At the same time ENGINEER will also give written notice to OWNER and CONTRACTOR that the Work is acceptable subject to the provisions of paragraph 14.09. Otherwise, ENGINEER will return the Application for Payment to CONTRACTOR, indicating in writing the reasons for refusing to recommend final payment, in which case CONTRACTOR shall make the necessary corrections and resubmit the Application for Payment.

##### C. *Payment Becomes Due*

1. Thirty days after the presentation to OWNER of the Application for Payment and accompanying documentation, the amount recommended by ENGINEER will become due and, when due, will be paid by OWNER to CONTRACTOR.

#### 14.08 *Final Completion Delayed*

A. If, through no fault of CONTRACTOR, final completion of the Work is significantly delayed, and if ENGINEER so confirms, OWNER shall, upon receipt of CONTRACTOR's final Application for Payment and recommendation of ENGINEER, and without terminating the Agreement, make payment of the balance due for that portion of the Work fully completed and accepted. If the remaining balance to be held by OWNER for Work not

fully completed or corrected is less than the retainage stipulated in the Agreement, and if Bonds have been furnished as required in paragraph 5.01, the written consent of the surety to the payment of the balance due for that portion of the Work fully completed and accepted shall be submitted by CONTRACTOR to ENGINEER with the Application for such payment. Such payment shall be made under the terms and conditions governing final payment, except that it shall not constitute a waiver of Claims.

#### 14.09 *Waiver of Claims*

A. The making and acceptance of final payment will constitute:

1. a waiver of all Claims by OWNER against CONTRACTOR, except Claims arising from unsettled Liens, from defective Work appearing after final inspection pursuant to paragraph 14.06, from failure to comply with the Contract Documents or the terms of any special guarantees specified therein, or from CONTRACTOR's continuing obligations under the Contract Documents; and

2. a waiver of all Claims by CONTRACTOR against OWNER other than those previously made in writing which are still unsettled.

### ARTICLE 15 - SUSPENSION OF WORK AND TERMINATION

---

#### 15.01 *OWNER May Suspend Work*

A. At any time and without cause, OWNER may suspend the Work or any portion thereof for a period of not more than 90 consecutive days by notice in writing to CONTRACTOR and ENGINEER which will fix the date on which Work will be resumed. CONTRACTOR shall resume the Work on the date so fixed. CONTRACTOR shall be allowed an adjustment in the Contract Price or an extension of the Contract Times, or both, directly attributable to any such suspension if CONTRACTOR makes a Claim therefor as provided in paragraph 10.05.

#### 15.02 *OWNER May Terminate for Cause*

A. The occurrence of any one or more of the following events will justify termination for cause:

1. CONTRACTOR's persistent failure to perform the Work in accordance with the Contract Documents (including, but not limited to, failure to supply sufficient skilled workers or suitable materials or equipment or failure to adhere to the progress schedule established under paragraph 2.07 as adjusted from time to time pursuant to paragraph 6.04);

2. CONTRACTOR's disregard of Laws or Regulations of any public body having jurisdiction;

3. CONTRACTOR's disregard of the authority of ENGINEER; or

4. CONTRACTOR's violation in any substantial way of any provisions of the Contract Documents.

B. If one or more of the events identified in paragraph 15.02.A occur, OWNER may, after giving CONTRACTOR (and the surety, if any) seven days written notice, terminate the services of CONTRACTOR, exclude CONTRACTOR from the Site, and take possession of the Work and of all CONTRACTOR's tools, appliances, construction equipment, and machinery at the Site, and use the same to the full extent they could be used by CONTRACTOR (without liability to CONTRACTOR for trespass or conversion), incorporate in the Work all materials and equipment stored at the Site or for which OWNER has paid CONTRACTOR but which are stored elsewhere, and finish the Work as OWNER may deem expedient. In such case, CONTRACTOR shall not be entitled to receive any further payment until the Work is finished. If the unpaid balance of the Contract Price exceeds all claims, costs, losses, and damages (including but not limited to all fees and charges of engineers, architects, attorneys, and other professionals and all court or arbitration or other dispute resolution costs) sustained by OWNER arising out of or relating to completing the Work, such excess will be paid to CONTRACTOR. If such claims, costs, losses, and damages exceed such unpaid balance, CONTRACTOR shall pay the difference to OWNER. Such claims, costs, losses, and damages incurred by OWNER will be reviewed by ENGINEER as to their reasonableness and, when so approved by ENGINEER, incorporated in a Change Order. When exercising any rights or remedies under this paragraph OWNER shall not be required to obtain the lowest price for the Work performed.

C. Where CONTRACTOR's services have been so terminated by OWNER, the termination will not affect any rights or remedies of OWNER against CONTRACTOR then existing or which may thereafter accrue. Any retention or payment of moneys due CONTRACTOR by OWNER will not release CONTRACTOR from liability.

15.03 *OWNER May Terminate For Convenience*

A. Upon seven days written notice to CONTRACTOR and ENGINEER, OWNER may, without cause and without prejudice to any other right or remedy of OWNER, elect to terminate the Contract. In such case, CONTRACTOR shall be paid (without duplication of any items):

1. for completed and acceptable Work executed in accordance with the Contract Documents prior to the effective date of termination, including fair and reasonable sums for overhead and profit on such Work;

2. for expenses sustained prior to the effective date of termination in performing services and furnishing labor, materials, or equipment as required by the Contract Documents in connection with uncompleted Work, plus fair and reasonable sums for overhead and profit on such expenses;

3. for all claims, costs, losses, and damages (including but not limited to all fees and charges of engineers, architects, attorneys, and other professionals and all court or arbitration or other dispute resolution costs) incurred in settlement of terminated contracts with Subcontractors, Suppliers, and others; and

4. for reasonable expenses directly attributable to termination.

B. CONTRACTOR shall not be paid on account of loss of anticipated profits or revenue or other economic loss arising out of or resulting from such termination.

15.04 *CONTRACTOR May Stop Work or Terminate*

A. If, through no act or fault of CONTRACTOR, the Work is suspended for more than 90 consecutive days by OWNER or under an order of court or other public authority, or ENGINEER fails to act on any Application for Payment within 30 days after it is submitted, or OWNER fails for 30 days to pay CONTRACTOR any sum finally determined to be due, then CONTRACTOR may, upon

seven days written notice to OWNER and ENGINEER, and provided OWNER or ENGINEER do not remedy such suspension or failure within that time, terminate the Contract and recover from OWNER payment on the same terms as provided in paragraph 15.03. In lieu of terminating the Contract and without prejudice to any other right or remedy, if ENGINEER has failed to act on an Application for Payment within 30 days after it is submitted, or OWNER has failed for 30 days to pay CONTRACTOR any sum finally determined to be due, CONTRACTOR may, seven days after written notice to OWNER and ENGINEER, stop the Work until payment is made of all such amounts due CONTRACTOR, including interest thereon. The provisions of this paragraph 15.04 are not intended to preclude CONTRACTOR from making a Claim under paragraph 10.05 for an adjustment in Contract Price or Contract Times or otherwise for expenses or damage directly attributable to CONTRACTOR's stopping the Work as permitted by this paragraph.

ARTICLE 16 - DISPUTE RESOLUTION\*

16.01 *Methods and Procedures*

A. Dispute resolution methods and procedures, if any, shall be as set forth in the Supplementary Conditions. If no method and procedure has been set forth, and subject to the provisions of paragraphs 9.09 and 10.05, OWNER and CONTRACTOR may exercise such rights or remedies as either may otherwise have under the Contract Documents or by Laws or Regulations in respect of any dispute.

ARTICLE 17 - MISCELLANEOUS\*

---

17.01 *Giving Notice*

A. Whenever any provision of the Contract Documents requires the giving of written notice, it will be deemed to have been validly given if delivered in person to the individual or to a member of the firm or to an officer of the corporation for whom it is intended, or if delivered at or sent by registered or certified mail, postage prepaid, to the last business address known to the giver of the notice.

17.02 *Computation of Times*

A. When any period of time is referred to in the Contract Documents by days, it will be computed to

exclude the first and include the last day of such period. If the last day of any such period falls on a Saturday or Sunday or on a day made a legal holiday by the law of the applicable jurisdiction, such day will be omitted from the computation.

17.03 *Cumulative Remedies*

A. The duties and obligations imposed by these General Conditions and the rights and remedies available hereunder to the parties hereto are in addition to, and are not to be construed in any way as a limitation of, any rights and remedies available to any or all of them which are otherwise imposed or available by Laws or Regulations, by special warranty or guarantee, or by other provisions of the Contract Documents, and the provisions of this paragraph will be as effective as if repeated specifically in the Contract Documents in connection with each particular duty, obligation, right, and remedy to which they apply.

17.04 *Survival of Obligations*

A. All representations, indemnifications, warranties, and guarantees made in, required by, or given in accordance with the Contract Documents, as well as all continuing obligations indicated in the Contract Documents, will survive final payment, completion, and acceptance of the Work or termination or completion of the Agreement.

17.05 *Controlling Law*

A. This Contract is to be governed by the law of the state in which the Project is located.

## **SUPPLEMENTAL GENERAL CONDITIONS**

These Supplementary Conditions amend or supplement the Standard General Conditions of the Construction Contract (No. 1910-8, 1996 Edition) and other provisions of the Contract Documents as indicated below. All provisions, which are not so amended or supplemental, remain in full force and effect.

The terms used in these Supplementary Conditions will have the meanings indicated in the General Conditions. Additional terms used in these Supplementary Conditions have the meanings indicated below, which are applicable to both the singular and plural thereof.

**SC-6.10** Delete paragraph 6.10 in its entirety and insert the following in its place:

*The owner qualifies for the state and local tax exemption in the purchase of certain materials and equipment the Contractor shall utilize the form provided herewith in exhibit "D".*

**SC-11.01** Delete paragraph 11.01 in its entirety.

**SC-11.02** Delete paragraph 11.02 in its entirety.

**SC-12.01B.25 & B.3.** Delete paragraph 12.01B.2 & B.3 in its entirety.

**SC-12.01.C.2** Delete paragraph 12.01.C.2 in its entirety.

**SC Article 14.02 C.1** Replace "Ten days" with "Thirty days" to read as follows: Thirty days after presentation of the Application for Payment to OWNER with ENGINEER'S recommendation, the amount recommended will (subject to the provisions of paragraph 14.02.D) become due, and when due will be paid by OWNER TO CONTRACTOR.

**SC Article 16** Add the following language at the end of the paragraph of Article 16:

*There are no dispute resolution methods and procedures set forth in the Supplemental Conditions:*

### **GENERAL PREVAILING WAGE LEGAL REQUIREMENTS**

The Contractor's attention is called to Texas Government Code Chapter 2258, which must be complied with attached herewith as Exhibit "C"

**GENERAL NOTES AND  
STANDARD SPECIFICATIONS**

ITEM 247. Flexible Base

Flexible Base Type E will be composed of caliche (argillaceous Limestone, calcareous or calcareous clay particles) and may contain stone, conglomerate, gravel, sand or granular materials when these materials are in situ with the caliche.

Blended material for Flexible Base TY E GR 4

The Contractor may blend base material with another caliche source or with crushed concrete, meeting the requirements for TY "E" materials, provided a minimum of 50% caliche is used. The crushed concrete may contain sand or granular materials. Stabilizing additives will not be allowed in the raw crushed concrete base. Acceptance will be under the following conditions:

- Condition One (1): When both components of the blend in their individual stockpiles meet all the physical requirements of this Item, then field blending will be allowed.
- Condition Two (2): When only one component of the blend passes the physical requirements of this Item, the materials shall be blended through a plant for stockpile testing and approval.

Flexible Base (TY E GR 4) shall conform to the following requirements:

BEFORE LIME IS ADDED

Retained on Sq. Sieve	Percent Retained
2"	0
½"	20-60
No. 4	40-75
No. 40	70-90
Max. PI:	15
Max. Wet Ball PI:	15
Wet Ball Mill Max Amount:	50
Min. Comp. Strength PSI:	150 at 15 PSI lateral pressure
Triaxial Test	Tex-117-E

The Wet Ball Test (Tex-116-E) shall be run and the Plasticity Index of the material passing the No. 40 sieve shall be determined (Wet Ball PI).

After 1% lime (laboratory) is added to unlimed material

Max PI	12
Min. Comp. Strength PSI:	180 at 15 PSI Lateral Pressure
Triaxial Test (Lime Treated)	Tex-121-E

# **Technical Specifications**

## TECHNICAL SPECIFICATIONS

<u>ITEM</u>	<u>DESCRIPTION</u>
Item 247	Flexible Base
Item 340	Hot Mix Asphaltic Concrete Pavement
Item 400	Excavation and Backfill for Structures
Item 402	Trench Excavation Protection
Item 464	Reinforced Concrete Pipe
Item 479	Adjusting Manholes and Inlets
Item 502	Barricades, Signs and Traffic Handling
Item 530	Driveways and Turnouts
Item 5010	Construction Exists
Item 5249	Temporary Sediment Control Fence

**Project Number:** BORDER COLONIA ACCESS PROGRAM

**County:** HIDALGO COUNTY PRECINCT #3

**Highway:** VARIOUS SUBDIVISIONS

## ITEM 247

### FLEXIBLE BASE

**247.1. Description.** This Item shall govern for the delivery, stockpiling and/or the construction of foundation or base courses as herein specified and in conformity with the typical sections and to the lines and grades shown on the plans or established by the Engineer.

**247.2. Materials.** The flexible base material shall be crushed or uncrushed as necessary to meet the requirements herein, and shall consist of durable coarse aggregate particles and binding materials.

**(1) General.** When off-right-of-way sources are involved, the Contractor's attention is directed to Item 7, "Legal Relations and Responsibilities to the Public".

**(2) Physical Requirements.**

**(a) General.** All types shall meet the physical requirements for the specified grade(s) as set forth in Table 1.

Additives, such as, but not limited to, lime, cement or fly ash, shall not be used to alter the soil constants or strengths shown in Table 1, unless otherwise shown on the plans.

Unless otherwise shown on the plans, the base material shall have a minimum Bar Linear Shrinkage of 2 percent as determined by Test Method Tex-107-E, Part II.

The flexible base shall be one of the following types, as follows:

**(b) Type A.** Type A material shall be crushed stone produced from oversize quarried aggregate, sized by crushing and produced from a naturally occurring single source. Crushed gravel or uncrushed gravel shall not be acceptable for Type A material. No blending of sources and/or additive materials will be allowed in Type A material.

**(c) Type B.** Type B material shall be crushed or uncrushed gravel.

**(d) Type C.** Type C material shall be crushed gravel. Unless otherwise shown on the plans, crushed gravel shall have a minimum of 60 percent of the particles retained on the No. 4 sieve with two (2) or more crushed faces as determined by Test Method Tex-460-A, Part I.

**(e) Type D.** As shown on the plans.

**Project Number:** BORDER COLONIA ACCESS PROGRAM

**County:** HIDALGO COUNTY PRECINCT #3

**Highway:** VARIOUS SUBDIVISIONS

**TABLE 1  
PHYSICAL REQUIREMENTS**

GRADE 1	GRADE 2	GRADE 3
Triaxial Class 1: Min. compressive strength, psi: 45 at 0 psi lateral pressure and 175 at 15 psi lateral pressure	Triaxial Class 1 to 2.3: Min. compressive strength, psi: 35 at 0 psi lateral pressure and 175 at 15 psi lateral pressure	Triaxial Class - Unspecified
Master Grading	Master Grading	Master Grading
1-3/4"                    0	2-1/2"                    0	2-1/2"                    0
7/8"                    10-35	1-3/4"                    0-10	1-3/4"                    0-10
3/8"                    30-50	No. 4                    45-75	No. 4                    30-75
No. 4                    45-65	No. 40                    60-85	No. 40                    50-85
No. 40                    70-85		
Max LL ..... 35	Max LL ..... 40	Max LL ..... 40
Max PI ..... 10	Max PI ..... 12	Max PI ..... 12
Wet Ball Mill	Wet Ball Mill	Wet Ball Mill
Max ..... 40	Max ..... 45	Max ..... 50
Max increase in passing	Max increase in passing	Max increase in Passing
No. 40 ..... 20	No. 40 ..... 20	No. 40 ..... 20

**Project Number:** BORDER COLONIA ACCESS PROGRAM

**County:** HIDALGO COUNTY PRECINCT #3

**Highway:** VARIOUS SUBDIVISIONS

**247.2**

GRADE 4	GRADE 5	GRADE 6
Triaxial Class Unspecified	Triaxial Class Unspecified	
Master Grading	Master Grading	As Shown on the Plans
1-3/4"..... 0	1-3/4" ..... 0	
No. 4.....45-75	No. 40.....50-85	
No. 40.....50-85		
Max LL..... 40	Max LL..... 40	
Max PI..... 12	Max PI..... 12	

Notes:

1. Gradation requirements are percent retained on square sieves.
2. When a magnesium soundness value is shown on the plans the material will be tested in accordance with Test Method Tex-411-A.
3. When lightweight aggregates are used, the wet ball mill requirements will not apply and the lightweight aggregate shall meet the Los Angeles Abrasion, Pressure Slaking and Freeze Thaw requirements of Item 303, "Aggregate for Surface Treatment (Lightweight)".

**(3) Pilot Grading.** When pilot grading is required on the plans, the flexible base shall not vary from the designated pilot grading of each sieve size by more than five (5) percentage points. However, the flexible base grading shall be within the master grading limits as shown in Table 1. The pilot grading may be varied by the Engineer as necessary to insure that the base material produced will meet the physical requirements shown in Table 1.

**(4) Testing.** Testing of flexible base materials shall be in accordance with the following Department standard laboratory test procedures:

Moisture Content	Tex-103-E
Liquid Limit	Tex-104-E
Plasticity Index	Tex-106-E
Bar Linear Shrinkage	Tex-107-E,

Part II

**Project Number:** BORDER COLONIA ACCESS PROGRAM

**County:** HIDALGO COUNTY PRECINCT #3

**Highway:** VARIOUS SUBDIVISIONS

Sieve Analysis	Tex-110-E
Moisture-Density Determination	Tex-113-E
Roadway Density	Tex-115-E
Wet Ball Mill	Tex-116-E
Triaxial Tests (Part I or II as selected by the Engineer)	Tex-117-E
Particle Count	Tex-460-A, Part I

Samples for testing the base material for triaxial class, soil constants, gradation and wet ball mill will be taken prior to the compaction operations.

**(5) Tolerances.** Unless otherwise shown on the plans, the limits establishing reasonably close conformity with the specified gradation and plasticity index are defined by the following:

**(a) Gradation.** The Engineer may accept the material, providing not more than one (1) out of the most recent five (5) consecutive gradation tests performed are outside the specified limits for master grading or pilot grading, as applicable, on any individual sieve by no more than five (5) percentage points.

**(b) Plasticity Index.** The Engineer may accept the material providing not more than one (1) out of the most recent five (5) consecutive plasticity index samples tested are outside the specified limit by no more than two (2) percentage points.

**(6) Material Sources.** The flexible base material shall be furnished by the Contractor. When a non-commercial source is utilized, it shall be opened in such manner as to immediately expose the vertical faces of all the various strata of acceptable material. Unless otherwise approved by the Engineer, the material shall be secured and processed by successive vertical cuts extending through all of the exposed strata.

Unless otherwise shown on the plans, the flexible base material shall be temporarily stockpiled prior to delivery to the roadway. Unless otherwise shown on the plans, the stockpile shall not be less than 10 feet in height and shall be made up of layers not greater than two (2) feet in thickness. After a sufficient stockpile has been constructed the Contractor may proceed with loading from the stockpile for delivery. In loading from the stockpile for delivery, the material shall be loaded by making successive vertical cuts through the entire depth of the stockpile.

When temporary stockpiles are to be tested for acceptance prior to delivery to its intended use, any stockpile that has been sampled and accepted shall not have material

**Project Number:** BORDER COLONIA ACCESS PROGRAM

**County:** HIDALGO COUNTY PRECINCT #3

**Highway:** VARIOUS SUBDIVISIONS

added or removed unless otherwise approved by the Engineer. The Contractor will be charged for additional sampling and testing required as a result of material being removed from a previously approved stockpile without the approval of the Engineer. Such charges will be deducted from the Contractor's estimates.

Blending of materials from more than one (1) source to produce Type B, C or D flexible base will be allowed when approved by the Engineer.

### **247.3. Construction Methods.**

#### **(1) Complete In Place**

**(a) Preparation of Subgrade or Existing Roadbed.** Prior to delivery of the base material, the subgrade or existing roadbed shall be shaped to conform to the typical sections, shown on the plans or established by the Engineer. This work shall be done in accordance with the provision of the applicable bid items.

When shown on the plans and directed by the Engineer, the Contractor shall proof roll the roadbed in accordance with Item 216, "Rolling (Proof)". Soft spots shall be corrected as directed by the Engineer.

**(b) First Course.** It shall be the responsibility of the Contractor to deliver the required amount of base material to each 100 foot station. Base material shall be spread uniformly and shaped the same day as delivered. In the event inclement weather or other unforeseen circumstances render this impractical, the material shall be shaped as soon as practical.

Prior to compacting the flexible base, the flexible base material shall be bladed and shaped to conform to the typical sections as shown on the plans. All areas of segregated coarse or fine material shall be corrected or removed and replaced with well graded material, as directed by the Engineer and at the Contractor's expense.

**Project Number:** BORDER COLONIA ACCESS PROGRAM

**County:** HIDALGO COUNTY PRECINCT #3

**Highway:** VARIOUS SUBDIVISIONS

### **247.3**

The Contractor shall sprinkle for dust control as directed by the Engineer.

**(c) Succeeding or Finish Courses.** Construction methods shall be the same as required for the first course. Throughout this entire operation, the shape of each course shall be maintained by blading. Upon completion, the surface shall be smooth and in conformity with the typical section as shown on the plans and the established lines and grades. Prior to placing the surfacing on the completed base, the base shall be cured to the extent directed by the Engineer.

**(d) Compaction Method.** The flexible base shall be compacted by "Density Control" as shown on the plans. Water used for compaction shall conform to the material requirements of Item 204, "Sprinkling".

The flexible base shall be sprinkled as required and compacted to the extent necessary to provide not less than 100 percent density as determined by Test Method Tex-113-E, unless otherwise shown on the plans. After each section of flexible base is completed, tests as necessary will be made by the Engineer in accordance with Test Method Tex-115-E. When the material fails to meet the density requirements, or it loses the required stability, density or finish before the next course is placed or the project is completed, it shall be reworked and retested in accordance with Section 247.3.(1)(e).

**(e) Reworking a Section.** Should the base course, due to any reason or cause, lose the required stability, density or finish before the surfacing is complete, it shall be reworked, recompacted and refinished at the sole expense of the Contractor.

**(f) Tolerances.** Tolerances shall conform to the following:

**(i) Density Tolerances.** The Engineer may accept the work providing not more than one (1) out of the most recent five (5) consecutive density tests performed is below the specified density, and providing that the failing test is no more than three (3.0) pounds per cubic foot below the specified density.

**(ii) Grade Tolerances.** In areas on which surfacing is to be placed, any deviation in excess of 1/4 inch in cross section or 1/4 inch in a length

**Project Number:** BORDER COLONIA ACCESS PROGRAM

**County:** HIDALGO COUNTY PRECINCT #3

**Highway:** VARIOUS SUBDIVISIONS

#### **247.4**

of 16 feet measured longitudinally shall be corrected by loosening, adding or removing material, reshaping and recompacting by sprinkling and rolling.

**(g) Thickness Measurement.** When the measurement is by the square yard, the flexible base will be measured for depth in units of 4000 square yards, or fraction thereof. The measurements will be at location(s) determined by the Engineer and performed in accordance with Test Method Tex-140-E. In any unit where flexible base is deficient by more than 1/2 inch in thickness, the deficiency shall be corrected by scarifying, adding material as required, reshaping, recompacting and refinishing at the Contractor's expense.

**(2) Roadway Delivery.** It shall be the responsibility of the Contractor to deliver the required amount of base material to each 100 foot station. All processing or manipulations will be in accordance with the applicable bid items.

**(3) Stockpile Delivery.** It shall be the responsibility of the Contractor to prepare the stockpile site, to provide and deliver the required amount of base material to the designated stockpile site and to construct the stockpile. Unless otherwise shown on the plans, the stockpile shall not be less than ten (10) feet in height and shall be made up of layers not to exceed two (2) feet in thickness.

**247.4. Measurement.** This Item will be measured by either Measurement Class 1, 2, 3, 4, or 5 as shown on the plans:

**(1) Measurement Class 1.** Measurement will be by the cubic yard in vehicles of uniform capacity.

**(2) Measurement Class 2.** Measurement will be by the ton of 2000 pounds dry weight in vehicles as delivered. A set of standard platform truck scales conforming to the requirements of Item 520, "Weighing and Measuring Equipment", shall be furnished by the Contractor and placed at a location approved by the Engineer. When the material is weighed during mixing or batching, reweighing will not be necessary. The dry weight will be determined by deducting the weight of the moisture in the material at the time of weighing from the gross weight of the material. The moisture in the material will be determined in accordance with Test Method Tex-103-E at least once each day and more often if conditions warrant.

**Project Number:** BORDER COLONIA ACCESS PROGRAM

**County:** HIDALGO COUNTY PRECINCT #3

**Highway:** VARIOUS SUBDIVISIONS

## **247.5**

**(3) Measurement Class 3.** Measurement will be by the cubic yard in the final stockpile position. The volume of flexible base will be computed in place between the natural ground and the top of the stockpile by the method of average end areas.

**(4) Measurement Class 4.** Measurement will be by the cubic yard in the completed and accepted final position. The volume of base course will be computed in place between the original subgrade or subbase surfaces, and the lines, grades and slopes of the accepted base course as shown on the plans by the method of average end areas.

Measurement Class 4 is plan quantity measurement Item and the quantity to be paid for will be that quantity shown in the proposal and on the "Estimate and Quantity" sheet of the contract plans, except as may be modified by Article 9.8. If no adjustment is required, additional measurements or calculations will not be required. No payment will be made for thickness or width exceeding that shown on the typical section or provided on the plans.

**(5) Measurement Class 5.** Measurement will be by the square yard of surface area in the completed and accepted position. The surface area of the base course will be based on the width of flexible base as shown on the plans.

Measurement Class 5 is a plans quantity measurement Item and the quantity to be paid for will be that quantity shown in the proposal and on the "Estimate and Quantity" sheet of the contract plans, except as may be modified by Article 9.8. If no adjustment is required, additional measurements or calculations will not be required. No payment will be made for thickness or width exceeding that shown on the typical section or provided on the plans.

### **247.5. Payment.**

The work performed and materials furnished in accordance with this Item and measured as provided under "Measurement" will be paid for at the unit price bid for "Flexible Base (Complete in Place)" of the type, grade and measurement class specified; for "Flexible Base (Roadway Delivery)" of the type, grade and measurement class specified; and for "Flexible Base (Stockpile Delivery)" of the type, grade and measurement class specified. This price shall be full compensation for securing and furnishing all materials, including royalty and freight involved; for furnishing scales and labor involved in weighing the material when required; for loosening, blasting, excavating, screening, crushing and temporary stockpiling when required; for loading all materials; for all hauling and delivering and for all manipulations; sprinkling; for rolling, except for proof rolling; sprinkling for dust control, for labor, tools and incidentals necessary to complete the work except as follows:

**Project Number:** BORDER COLONIA ACCESS PROGRAM

**County:** HIDALGO COUNTY PRECINCT #3

**Highway:** VARIOUS SUBDIVISIONS

When the plans specify "Flexible Base (Complete in Place)", the unit price bid shall be full compensation for shaping and fine grading the roadbed; and for spreading, mixing, blading, compacting, shaping, finishing, and curing the base material.

When the plans specify "Flexible Base (Roadway Delivery)", the unit price bid will not include processing at the roadway. Measurement will be only by Measurement Class 1 or 2.

When the plans specify "Flexible Base (Stockpile Delivery)", the unit price bid also will be full compensation for preparing the stockpile area and for spreading and shaping the material in the stockpile. Measurement will be only by Measurement Class 1, 2, or 3.

When proof rolling is shown on the plans, and when directed by the Engineer, it will be paid for in accordance with Item 216, "Rolling (Proof)".

When subgrade is constructed under this project, correction of soft spots will be at the Contractor's expense. When subgrade is not constructed under this project, correction of soft spots in the subgrade or existing roadbed will be in accordance with Article 4.3.

**SPECIFICATION AS PER HIDALGO COUNTY For Colonia Program**

**Hot Mix Asphaltic Concrete Pavement**

**PART 1 - GENERAL**

1.01 DESCRIPTION:

- A. Hot mix asphalt concrete (HMAC) pavement shall consist of a binder course, a leveling up course, a surface course or a combination of the courses as shown on the plans, or as directed by the ENGINEER.
- B. HMAC pavement shall be composed of a compacted mixture of mineral aggregate and asphaltic material, constructed on previously completed and approved subgrade, subbase course, base course, or existing pavement.
- C. HMAC pavement shall be in accordance with the specifications herein and in conformity with the lines, grades, quantities and typical sections in the contract and/or as directed by the ENGINEER.

1.02 QUALITY CONTROL:

- A. HMAC pavement and its constituent part shall conform to the ASTM, AASHTO and/or Texas SDHPT test methods noted below.

**PART 2 - PRODUCTS**

2.01 ASPHALTIC MATERIALS:

- A. Asphalt cement binders shall be uncracked petroleum asphalt and shall be carefully refined, by steam, vacuum, or solvent, from asphaltic or semi-asphaltic base crude petroleum at a temperature not to exceed 700 degrees F. Asphalt cements shall be free from thermal decomposition products and shall not be blended with any materials which have been subjected to cracking or produced from a crude petroleum source other than that of the original material. The asphalt cement shall not contain residues from non-asphaltic sources. Asphalt cement shall be homogeneous, free from water, and shall not foam when heated to 347 degrees F.
- B. Paving asphalt shall be classified by penetration or viscosity and shall conform to the requirements set forth in one of the following tables as designated by the ENGINEER. The CONTRACTOR may supply asphalt meeting the requirements of one of the following tables provided that he obtains prior approval of the ENGINEER and with the provision that once approval has been obtained, that the CONTRACTOR will remain with that grade throughout the project.

TABLE 02612-1

Specification Designation	AASHTO Test Method	ASTM Test Method	40 to 50	60 to 70	85 to 100	120 to 150	150 to 200	200 to 250
Flash Point (Open cup) Min.	T48	D92	450	450	450	425	350	
Penetration of Orig. Sample at 77	T49	D5	40 to 50	60 to 70	85 to 100	120 to 150	150 to 200	200 to 250

Thin-Film Oven Loss, Hours at 325 F, % Max	T179	D1754	0.75	0.75	0.75	0.75	1.00	1.00
--	------	-------	------	------	------	------	------	------

Test of Residue from Thin-Film Oven Test: % of Orig. Pen., Min. T49	D5	52	50	50	50	50	50	50
--	----	----	----	----	----	----	----	----

Ductility at 77 F, cm. after Loss at 325 F, Min.	T51	D113	50	50	100	100	100	100
---	-----	------	----	----	-----	-----	-----	-----

Solubility in CC1 4 Min.	T44*	None	99.5	99.5	99.5	99.5	99.5	99.5
-----------------------------	------	------	------	------	------	------	------	------

Reaction to Spot Test	T102**	None	-0-	-0-	-0-	-0-	-0-	-0-
--------------------------	--------	------	-----	-----	-----	-----	-----	-----

\* Procedure No. 1 with CC1 4 substituted for CS2.

\*\* Using 85% Standard Naphtha Solvent and 15% xylene.

TABLE 02612-2

OA-30	OA-175*8	OA-400			
TYPE-GRADE	Min.	Max	Min.	Max	Min.Max
Penetration at 32 F, 200g., 60 sec	15	--	--	--	--
Penetration at 77 F, 100g., 5 sec	25	35	150	200	--
Penetration at 115 F, 50g., 5 sec	--	65	--	--	--
Ductility at 77 F, 5 Original OA	2	--	70	--	--
Flash Point C.O.C.,F	450	--	425	--	425
Softening Point, R.&B.,F		185	--	95	130
Thin Film Oven Test, 1/8 in.Film 50 g., 5hrs.,325 F, % Loss by wt	--	0.4	--	1.4	--
Penetration of Residue, at 77 F, 100g., 5 sec. % of Original Pen	--	--	40	--	--
Ductility of Residue at 77 F, 5					

Hidalgo County Specification  
Hot Mix Asphaltic Concrete Pavement

cm/min., cms	-- -- --	100	-- --
Solubility in Trichloroethylene, %	99.0	-- 99.0	-- 99.0 --
Spot Test on Original OA	Neg.	Neg.	Neg.
Float Test at 122 F, sec	-- -- --	--	120 150
Test on 85 to 115 Pen. Residue*			
Residue by Wt., %	-- -- --	--	75 --
Ductility, 77 F, 5 cm/min:			
Original Res., cms	-- -- --	--	100 --
Subjected to Thin Film Test, cms	-- -- --	--	100 --

\*Determined by Vacuum Distillation (by evaporation if unable to reduce by vacuum).

\*\*For use with Latex Additive only.

TABLE 02612-3

PROPERTIES	AC-1.5		AC-3		AC-5		AC-10		AC-20		AC-20	
	MIN	MAX	MIN	MAX	MIN	MAX	MIN	MAX	MIN	MAX	MIN	MAX
Viscosity, 140F Stokes	150	50	300	100	500	100	1000	200	2000	400	4000	800
Viscosity, 275 F stokes. . . .	0.7	--	1.1	--	1.4	--	1.9	--	2.5	--	3.5	--
Penetration, 77 F 100 g, 5 sec. .	250	--	210	--	135	--	85	--	55	--	35	--
Flash Point, C.O.C., F. . . .	425	--	425	--	425	--	450	--	450	--	450	--
Solubility in trichloroethylene, percent . . .	99.0	--	99.0	--	99.0	--	99.0	--	99.0	--	99.0	--
Test on residues from thin film oven test: Viscosity, 140F stokes. . . .	--	450	--	900	1500	--	3000	--	6000	--	--	12000
Ductility, 77 F, 5 cms per min, cms	100	--	100	--	100	--	70	--	50	--	30	--
Spot test. . . .	Negative for all grades											

C. A minimum of two percent, by weight, latex additive (solids basis) shall be added to the OA-175 Asphalt or to AC-5 Asphalt when specified in the contract. The latex additive shall be governed by the following specifications:

The latex is to be an anionic emulsion of butadiene-styrene low-temperature copolymer in water, stabilized with fatty-acid soap so as to have good storage stability, and possessing the following properties:

Monomer ratio, B/S	70/30
Minimum solids content	67%
Solids content per gal. @ 67%	5.3 lbs.
Coagulum on 80-mesh screen	0.01% max.
Type Anti-oxidant	staining
Mooney viscosity of Polymer (M/L 4 @ 212F)	100 min.
pH of Latex	9.4 - 10.5
Surface tension	28-42 dynes/cm <sup>2</sup>

The finished latex-asphalt blend shall meet the following requirements:

Viscosity at 140 F, stokes	1500 max.
Ductility at 39.2 F. 1 cm. per., cm	100 min.

D. Asphalt content shall be within the limits noted below:

HMAC Type	Percent of Mixture by Weight	Percent of Mixture by Volume
"D"	4.0 - 8.0	9.0 - 19.0

- E. At the time of delivery of each shipment of asphalt, the vendor supplying the material shall deliver to the purchaser certified copies of the test report which shall indicate the name of the vendor, type and grade of asphalt delivered, date and point of delivery, quantity delivered, delivery ticket number, and results of the above-specified tests. The test report shall be certified and signed by an authorized representative of the vendor that the product delivered conforms to the specifications for the type and grade indicated.
- F. Until the certified test reports and samples of the material have been checked by the ENGINEER to determine their conformity with the prescribed requirements, the material to which such report relates an any work in which it may have been incorporated as an integral component will be only tentatively accepted by the County and/or City. Final acceptance will be dependent upon the determination of the ENGINEER that the material involved fulfills the requirements prescribed therefor. The certified test reports and the testing required in connection with the reports will be at the expense to the County and/or City.
- G. Unless otherwise specified in these specifications or in the Supplementary Specifications, the various grades of paving asphalt shall be applied at a temperature range of from 210 F, the exact temperature to be determined by the ENGINEER.
- H. Paving asphalt shall be heated in such a manner that steam or hot oils will not be introduced directly into the paving asphalt during heating. The CONTRACTOR shall furnish and keep on the site, at all times, an accurate thermometer suitable for determining the temperature of the paving asphalt.
- I. HMAC asphalt shall be the grade having the highest penetration, within specified limits, to produce a mix having a maximum stability of the compacted mixtures.
- J. Only one (1) grade of asphalt 64-22 (AC-20) shall be required unless otherwise shown on the plans or as required by the ENGINEER.

2.02 AGGREGATES:

A. HMAC aggregate will be tested in accordance with the following test:

- AASHTO T-30 Mechanic Testing
- AASHTO T-27 Passing No. 200 Sieve
- AASHTO T-89 Liquid Limit
- AASHTO T-96 Los Angeles Abrasion
- AASHTO T-104 Soundness (Magnesium Sulfate)
- ASTM C - 131 Resistance to Degradation
- ASTM C - 136 Sieve Analysis
- ASTM C - 2419 Sand Equivalence Value
- SDHPT Tex - 106-EMethod of Calculating Plasticity Index of Solids
- SDHPT Tex-217 - F(I & II) Determination of Deleterious Materials and Decantation Test
- SDHPT Tex-203 - FQuality Tests for Mineral Aggregates

- B. Aggregates shall have an abrasion of not more than 40 for all course except the non-skid surface course, which shall have an abrasion of not more than 35.
- C. When property proportioned, HMAC aggregate shall produce a gradation which will conform to the limitations for classification for HMAC type shown below, or as directed by the ENGINEER.
- D. Course aggregate to be crushed limestone rock or crushed gravel with hydrated lime or limestone filler. (Crushed gravel shall be per Highway Department Specifications.)
- E. Binder aggregate to be composed of not less than 15% field sand or as directed by the engineer.

4. Type "D" - Fine Graded Surface Course

Percent Aggregate by  
Weight or Volume

Passing 1/2" sieve	100 to 100
Passing 3/8" sieve	85 to 100
Passing 3/8" sieve, retained on No.4 sieve	21 to 53
Passing No.4 sieve, retained on No.10 sieve	11 to 32
Total retained on No.10 sieve	54 to 74
Passing No.10 sieve, retained on No.40sieve	6 to 32
Passing No.40 sieve, retained on No.80sieve	4 to 27
Passing No.80 sieve,retained on No.200sieve	3 to 27
Passing No.200 sieve	1 to 8

2.03 PRIME COAT:

A. Prime coat, when specified on the plans, or as directed by the ENGINEER, shall be in accordance with Section 02610 - Prime Coat, and as specified herein.

- B. Prime coat shall be applied to surfaces of bases at least 12 hours prior to placing the HMAC unless otherwise directed by the ENGINEER.
- C. Asphalt prime shall be applied uniformly at the rate of 0.20 to 0.30 gallon per square yard or as directed by the ENGINEER. It shall be applied only when permitted by the ENGINEER and when the air temperature is 40 F and rising.
- D. In order to prevent lapping at the junction of two applications, the distributor shall be promptly shut off. A hand spray shall be used to touch up all spots unavoidably missed by the distributor.
- E. Immediately prior to application of the asphalt prime, an inspection will be made by the ENGINEER to verify that the base course has been constructed as specified. Also, all loose and foreign material shall be removed by light sweeping. Material so removed shall not be mixed with cover aggregate.
- F. The surface to be primed shall be in a smooth and well-compacted condition, true to grade and cross section, and free from ruts and inequalities.
- G. The pressure distributor used for applying prime coat material shall be equipped with pneumatic tires and shall be so designed and operated as to distribute the prime material in a uniform spray without atomization, in the amount and between the limits of temperature specified. It shall be equipped with a speed tachometer registering feet per minute and so located as to be visible to the truck driver to enable him to maintain the constant speed required for application at the specified rate.
- H. The pressure distributor shall be equipped with a tachometer registering the pump speed, pressure gauge, and a volume gauge. The rates of application shall not vary from the rates specified by the ENGINEER by more than 10%. Suitable means for accuracy indicating at all times the temperature of the prime material shall be provided. The thermometer well shall be so placed as not to be in contact with a heating tube.
- I. The distributor shall be so designed that the normal width of application shall be not less than 6 feet, with provisions for the application of lesser width when necessary. If provided with heating attachments, the distributor shall be so equipped and operated that the prime material shall be circulated or agitated through the entire heating process.
- J. The asphalt prime coat should preferably be entirely absorbed by the base course and, therefore, require no sand cover. If, however, it has not been completely absorbed prior to the start of placing the asphalt concrete mixture and in the meantime it is necessary to permit traffic thereon, just sufficient sand shall be spread over the surface to blot up the excess liquid asphalt and prevent picking it up under traffic. Also, sand shall be used in areas where traffic may pass over the prime coat. Prior to placing the asphalt concrete, loose or excess sand shall be swept from the base. If a sand cover is specified in the Supplementary Specifications or noted on the plans to cover asphalt prime, it shall be applied within 4 hours after the application of said prime coat, unless otherwise ordered by the ENGINEER.
- K. Liquid asphalt shall be prevented from spraying upon adjacent pavements, structures, guard rails, guide posts, culvert markers, trees, and shrubbery that are not to be removed; adjacent property and improvements; and other facilities or that portion of the traveled way being used by traffic.
- L. The CONTRACTOR shall protect the prime coat against all damage and markings, both from and other traffic. Barricades shall be placed where necessary to protect the prime coat. If, after prime coat has been applied satisfaction of the ENGINEER and has been accepted by him, it is distributed by negligence on the part of the CONTRACTOR, it shall be restored at his expense to its condition at the time of acceptance. No material shall be placed until the prime coat is in a condition satisfactory to the ENGINEER.

2.04 TACK COAT:

- A. If the asphalt concrete pavement is being constructed directly upon an existing hard-surfaced pavement, a tack coat shall be evenly and uniformly applied to such existing pavement preceding the placing of the asphalt concrete. The surface shall be free of water, all-foreign material, or dust when the tack coat is applied. No

greater area shall be treated in any one day than will be covered by the asphalt concrete during the same day. Traffic will not be permitted over tack coating.

- B. Tack coat for HMAC shall consist of either rapid curing cut-back asphalt RC-2 diluted by addition of (not to exceed 15 percent by volume) an approved grade of gasoline and/or kerosene; emulsified asphalt, EA-11M diluted with 50 percent water, or a cut-back asphalt made by combining 50 to 70 percent of the asphaltic materials specified for the paving mixture with 30 to 50 percent gasoline and/or kerosene by volume.
- C. Tack coat shall conform to the requirements of Section 02620 - Tack Coat, or as specified herein.
- D. Application rate shall be 0.10 to 0.15 gallons per square yard as directed by the ENGINEER.
- E. A similar tack coat shall be applied to the surface of any course if, in the opinion of the ENGINEER, the surface is such that a satisfactory bond cannot be obtained between it and the succeeding course.
- F. When required, the contact surfaces of all cold pavement joints, curbs, gutters, manholes, and the like shall be painted with a tack coat immediately before the adjoining asphalt concrete is placed. Asphalt tack coat shall be applied in controlled amounts as shown on the plans or determined by the ENGINEER. Surfaces where a tack coat is required shall be cleaned to the satisfaction of the ENGINEER before the tack coat is applied.

2.05 MINERAL FILLER:

- A. Mineral filler, other than hydrated lime, shall consist of a thoroughly dry stone dust, portland cement or other mineral dust approved by the ENGINEER.
- B. The mineral filler shall be free from foreign or other deleterious matter.
- C. When tested by the method outlined in SDHPT Test Method Tex-200-F (Part 1 or 3), mineral filler shall meet the following gradations by weight:

Passing No. 30 Sieve	95-100%
Passing No. 80 Sieve	75%
Passing No. 200 Sieve	55%

2.06 Anti-Stripping compound, as required in the job mix formula, shall be furnished in the amounts calculated therein. Lime 1% by wt. of aggregate.

2.07 JOB MIX FORMULA:

- A. A job mix formula based on representative samples, including filler if required, shall be determined by the ENGINEER, or submitted by the CONTRACTOR for approval of the ENGINEER.
- B. The resultant job mix formula shall be within the master range for the specified type of HMAC.
- C. The job mix formula for each mixture shall established a single percentage of aggregate passing each required sieve size, and a single percentage of bituminous material to be added to the aggregate and shall provide for 3 to 5% air voids in the resultant design mix.

During the mix design process the ENGINEER will consider other factors, in addition to air voids and Marshall stability, such as durability, water resistance and asphalt film thickness when developing the mix design.

- D. After the job mix formula is established, mixtures for the project shall conform thereto within the following tolerances which may fall outside of the specified master range:

.....Percent by Weight or  
.....Volume as Applicable

Passing 1-3/4" sieve, retained on 7/8" sieve	Plus or minus 5
Passing 7/8" sieve, retained on 3/8" sieve	Plus or minus 5
Passing 5/8" sieve, retained on 3/8" sieve	Plus or minus 5
Passing 3/8" sieve, retained on No.4 sieve	Plus or minus 5
Passing No.4 sieve, retained on No.10 sieve	Plus or minus 5
Total retained on No.10 sieve	Plus or minus 5
Passing No.10 sieve, retained on No.40 sieve	Plus or minus 3
Passing No.40 sieve, retained on No.80 sieve	Plus or minus 3
Passing No.80 sieve, retained on No.200 sieve	Plus or minus 3
Passing No.200 sieve	Plus or minus 3

Asphaltic Material wt or 1.2 by vol. Plus or minus 0.05 by

Mixing Temperature Plus or minus 20 F

E. Asphaltic mixture shall be tested in accordance with SDHPT Test Method Tex-200-4 (Part I or Part III) and shall have the following laboratory values:

..... <u>Surface Course</u>		..... <u>Base Course</u>	
Density— Minimum.....	95%.....	95%.....	95%
Maximum.....	99%.....	99%.....	99%
Optimum.....	97%.....	97%.....	97%
Voids.....	3 - 7%.....	4 - 7%.....	4 - 7%
Voids Filled With Asphalt.....	75 - 85%.....	65 - 80%.....	65 - 80%
Sand Equivalent.....	45.....	45.....	45

Combined mineral aggregate prior to additional of asphalt and mineral.

2.08 EQUIPMENT:

- A. All equipment for the handling of all material, mixing, and placing of HMAC shall be in accordance with the provisions of Texas SDHPT Item 340.

2.09 STOCKPILING, STORAGE, PROPORTIONING AND MIXING:

- A. Stockpiling, storage proportioning and mixing operations shall be in accordance with the Provisions of Texas SDHPT Item 340.

**PART 3 - EXECUTION**

3.01 WEATHER AND TEMPERATURE LIMITATIONS:

- A. Asphaltic mixture, when placed with a spreading and finishing machine, or the tack coat shall not be placed when the air temperature is 50 F and falling, but may be placed when the air temperature is 40 F and rising.
- B. Asphaltic mixture, when placed with a motor grader, shall not be placed when the air temperature is 60 F and falling, but may be placed when the air temperature is 50 F and rising.
- C. Mat thicknesses of 1½ inches and less shall not be placed when the temperature on which the mat is to be laid is below 50 F.

- D. No tack coat or asphaltic mixture shall be placed when the humidity, general weather conditions and temperature and moisture condition of the base, in the opinion of the ENGINEER, are unsuitable.
- D. If, after being discharged from the mixer and prior to placing, the temperature of the asphaltic mixture is 50 F or more below the temperature established by the ENGINEER, all or any part of the load may be rejected and payment will not be made for the rejected material.

3.02 EQUIPMENT:

A. Hauling Equipment:

1. Trucks used for hauling asphaltic mixtures shall have tight, clean, smooth metal beds which have been thinly coated with a minimal amount of paraffin oil, lime slurry, tine solution or other approved material to prevent mixture adhesion to the bed.
2. The dispatching of hauling equipment shall be arranged so that all material delivered may be placed and all rolling completed during daylight hours, unless otherwise directed by the ENGINEER.
3. All trucks shall be equipped with a cover of canvas, or other suitable material to protect the mixture from weather or on hauls where the temperature of the mixture will fall below specified level. Use of covers will be as directed by the ENGINEER.

B. Rollers:

1. Pneumatic Tire Roller. This roller shall consist of not less than seven pneumatic tire wheels, running on axles in such manner that the rear group of tires shall cover the entire gap between adjacent tires of the forward group; mounted in a rigid frame; and provided with a loading platform or body suitable for ballast loading. The front axle shall be attached to the frame in such manner that the roller may be turned within a minimum circle. The tire shall afford surface contact pressures up to 90 pounds per square inch or more. The roller shall be so constructed as to operate in both a forward and a reverse direction with suitable provisions for moistening the surface of the tires while suitable provisions for moistening the surface of the tires while operating; and shall be approved by the ENGINEER.
2. Two Axle Tandem Roller. This roller shall be acceptable power-driven, steel-wheel, tandem roller weighing not less than eight tons. It must operate in forward and reverse directions; contain provision for moistening the surface of the wheels while in motion; and shall be approved by the ENGINEER.
3. Three Wheel Roller. This roller shall be an acceptable power-driven, all steel three wheel roller weighing not less than 10 tons. It must operate in forward and reverse directions; contain provisions for moistening the surface of the wheel while in motion; and shall be approved by the ENGINEER.
4. Vibratory Steel Wheel Roller. If approved for use by the OWNER, this roller shall have a minimum weight of six tons. The compactor shall be equipped with amplitude and frequency controls and shall be specifically designed to compact the material on which it is used. It shall be operated in accordance with the manufacturer's recommendations.

C. Straight Edges:

1. The CONTRACTOR shall provide an acceptable 16-foot straight-edges for surface testing. Satisfactory templates shall be provided as required by the ENGINEER.

D. Spreading and Finishing Machine:

1. Bituminous pavers shall be self-contained, power-propelled units, provided with an activated screed or a strike-off assembly, heated if necessary, and capable of spreading and finishing courses of bituminous plant mix material in lane widths applicable to the specified typical section and thickness shown on the plans.
2. The paver shall be equipped with a receiving hopper having sufficient capacity for a uniform spreading operation. The hopper shall be equipped with a distribution system to place the mixture uniformly in front of the screed. Design will be such that no part of the truck weight will be supported by the paver.
3. The screed or strike-off assembly shall effectively produce a finished surface of the required evenness and texture without tearing, shoving or gouging the mixture. When laying mixtures, the paver shall be capable of being operated at forward speeds consistent with satisfactory laying of the mixture. The screed shall be adjustable for both height and crown and shall be equipped with a controlled heating device.
4. The bituminous paver shall be equipped with an automatic leveling device controlled from an external guide. The initial pass for each course shall be made using a paver equipped with a 40-foot minimum external reference, except that this requirements will not apply when asphalt concrete is placed adjacent to portland cement concrete pavement. Subsequent passes may utilize the matching device of one foot minimum length riding on the adjacent lay.

3.03 CONSTRUCTION METHODS:

A. Spreading and Finishing:

1. The asphalt concrete mixture shall be laid on the approved surface, spread and struck off to the grade and elevation established. It shall be spread and compacted in layers as shown on the plans or as directed by the ENGINEER. Bituminous pavers shall be used to distribute the mixture either over the entire width or over such partial width as may be practicable.
2. The ENGINEER will determine a minimum placement temperature within a range from 220 F to 300 F which will produce the required density. The established placement temperature, which is measured immediately behind the laydown machine, shall not vary more than 20 F. If, after being discharged from the mixer and prior to placing, the temperature of asphaltic mixture is 50 F or more below the temperature established by the Engineer, all or any part of the load may be rejected and payment will not be made for rejected material.
3. A conventional paver or suitable equipment approved by the ENGINEER may be used to place asphalt concrete material on shoulders depressed from the traveled lanes in order to establish a uniform typical section. Approval of the equipment used will be based upon the results obtained.
4. The asphalt concrete may be dumped from the hauling vehicles directly into the paving machine or it may be dumped upon the surface being paved and subsequently loaded into the paving machine; however, no asphaltic concrete shall be dumped from the hauling vehicles at a distance greater than 250 feet in front of the paving machine. When asphaltic concrete is dumped first upon the surface being paved, the loading equipment shall be self-supporting and shall not exert any vertical load on the paving machine. Substantially all of the asphaltic concrete dumped shall be picked up and loaded into the paving machine.
5. To achieve, as far as practicable, a continuous operation, the speed of the paving machine shall be coordinated with the production of the plant. Sufficient hauling equipment shall be available to insure continuous operation.
6. The control system shall control the elevation of the screed at each end by controlling the elevation of one end directly and the other indirectly either through controlling the transverse slope or alternately when directed, by controlling the elevation of each end independently, including any screed attachment used for widening, etc. Failure of the control system to function properly shall be cause for the suspension of the asphaltic concrete operations.

7. When dumping directly into the paving machine from trucks, care shall be taken to avoid jarring the machine or moving it out of alignment.
8. All courses of asphaltic concrete shall be placed and finished by means of self-propelled paving machines except under certain conditions or at certain locations where the ENGINEER deems the use of self-propelled paving machines impracticable.
9. Self-propelled paving machines shall spread the asphaltic concrete without segregation or tearing within the specified tolerances, true to the line, grade, and crown indicated on the plans. Pavers shall be equipped with hoppers and augers which will place the asphaltic concrete evenly in front of adjustable screeds without segregation. Screeds shall include any strike-off device operated by tamping or vibrating action which is effective without tearing, shoving or gouging the asphaltic concrete and which produces a finished surface of an even and uniform texture for the full width being paved. Screeds shall be adjustable as to height and crown and shall be equipped with a controlled heating device for use when required.
10. On areas where irregularities or unavoidable obstacles make the use of mechanical spreading and finishing equipment impracticable, the mixture shall be spread, raked, fluted and compacted with hand tools. For such areas the mixture shall be dumped, spread and screed to give the required compacted thickness.

B. Compaction:

1. Rolling with the 3-wheel and tandem roller shall start longitudinally at the sides and proceed toward the center of the surface course, overlapping on successive trips by at least half the width of the rear wheels.
2. Alternate trips of the roller shall be slightly different in length.
3. Rolling with a pneumatic tired roller shall be as directed by the ENGINEER.
4. Rolling shall continue with no further compression can be obtained and all roller marks are eliminated.
5. The motion of the roller shall be slow enough at all times to avoid displacement of asphaltic materials. If displacement occurs, it shall be corrected immediately by use of rakes and fresh asphaltic mixtures, where required.
6. The roller shall not be allowed to stand on the surface course when it has not been fully compacted and allowed to cool.
7. To prevent adhesion of the surface course to the roller, the wheels shall be kept thoroughly moistened with water; however, excess water shall not be allowed.
8. All precautions shall be taken to prevent dripping of gasoline, oil, grease, or other foreign substances on the surface or base courses during rolling operations or while rollers are standing.
9. With the approval of the ENGINEER, a vibratory steel wheeled roller may be substituted for the 3-wheel roller and tandem roller.
10. Along forms, curbs, headers, walls and other places not accessible to the rollers, the mixture shall be thoroughly compacted with hot hand tampers, smoothing irons, or with mechanical tampers. On depressed areas, a trench roller may be used or cleated compression strips may be used under the roller to transmit compression to the depressed area.
11. Any mixture that becomes loose, broken, mixed with dirt, segregated, or is in any way defective shall be removed and replaced with fresh hot bituminous mixture, which shall be compacted to conform with the surrounding area. Any area showing excess or deficiency of bituminous material shall be corrected immediately as directed by the ENGINEER.

C. In-Place Density:

1. In-place density shall be required for all mixtures except thin irregular depth leveling courses.
2. Each course, after final compaction, shall have a density of not less than 96 percent of the density developed in the laboratory test method outlined in Texas SDHPT Bulletin C-14.
3. Density shall be determined with a portable nuclear test device in conformity with ASTM D-2950.76.
4. Calibration of the portable nuclear device will be established by the ENGINEER from cut pavement samples tested in accordance with AASHTO T-166 (weight, volume method). The density readings of the cut pavement samples determined in accordance with AASHTO T-166 (weight, volume method), and the density readings of the pavement samples determined by the portable nuclear test device in conformity with ASTM D 2950 will be correlated by the ENGINEER.
5. Other methods of determining in-place density may be used as deemed necessary by the ENGINEER.
2. 6. It is intended that acceptance density testing will be done while the bituminous mixture is hot enough to permit further compaction if necessary. If the density of an acceptance section does not meet the specified requirements, the CONTRACTOR shall continue the compaction effort until the optimum density is obtained, but rolling for any compactive effort will not be allowed when the temperature of the mix is below 175 F unless authorized in writing by the ENGINEER. Rerolling the paved surface after it has initially cooled will not be allowed. Regardless of the method of compaction control followed, all rolling shall be completed before the mixture temperature drops below 175 F.
7. If in-place density tests of the mixture produce a value lower than specified and in the opinion of the ENGINEER is not due to a change in the quality of the material, production may proceed with subsequent changes in the mix and/or construction procedures until in-place density equals or exceeds the specified density.
8. In-place density tests will be provided by the ENGINEER unless otherwise specified.

D. Joints:

1. Placing of the asphalt concrete shall be as continuous as possible. Rollers shall not pass over the unprotected end of a freshly laid mixture unless authorized by the ENGINEER.
2. When plant mix bituminous pavement is placed over plant mix bituminous treated base or when plant mixed seal coat is placed over plant mix bituminous pavement, longitudinal joints shall be staggered at least 6 inches with relation to the longitudinal joints of the underlying course.
3. Transverse joints shall have a two foot or 12:1 minimum taper. Longitudinal joints shall have a one foot or 6:1 minimum taper. All transverse tapers shall be cut and squared off prior to commencing new work. Tapered longitudinal joints from previous operations shall be cleaned and tack coated if directed by the ENGINEER. All joints shall be completely bonded. The surface of each course at all joints shall be smooth and shall not show any deviations in excess of 3/16 of an inch when tested with a 10-foot straightedge in any direction.
4. When paving under traffic the CONTRACTOR shall plan his daily surfacing operations on a schedule which will result in not more than one (1) day's operation of exposed longitudinal joints.
5. The longitudinal joints shall not have a height greater than two (2) inches and shall not be left exposed longer than 24 hours.

E. Surface Tolerance:

1. Upon completion, the pavement shall be true to grade and cross section. Except at intersections or any changes of grade, when a 16 foot straight edge is laid on the finished surface parallel to the centerline of the roadway, the surface shall not vary from the edge of the straight edge more than 1/16-inch per foot. Areas that are not within this tolerance shall be brought to grade immediately following the initial rolling. After the completion of final rolling, the smoothness of the course shall be checked, and the irregularities that exceed the specified tolerances or that retain water on the surface shall be corrected by removing the defective work and replacing with new material as directed by the ENGINEER at the expense of the CONTRACTOR.

F. Manholes and Valve Covers:

1. Manhole frames and valve covers shall be adjusted prior to placing the surface course.

G. Compacted Thickness of HMAC Surface and Base Courses:

1. Surface Courses. The compacted thickness or depth of the asphaltic concrete surface course shall be as shown on the plans. Where the plans require a depth or thickness of the surface course greater than two inches compacted depth, same shall be placed in multiple courses of equal depth, each of which shall not exceed two inches compacted depth. If, in the opinion of the ENGINEER, an additional tack coat is considered necessary between any of the multiple courses, it shall be applied at the rate as directed.
2. Base Courses. The compacted thickness or depth of each base course shall be as shown on the plans. Where the plans require a depth or thickness of the course greater than 4 inches, same shall be accomplished by constructing multiple lifts of approximately equal depth, each of which shall not exceed these maximum compacted depths. If, in the opinion of the ENGINEER, an additional tack coat is considered necessary between any of the multiple lifts, it shall be applied as hereinbefore specified and at the rate as directed.

H. Pavement Thickness Tests:

1. Pavement Thickness Test. Upon completion of the work and before final acceptance and final payment shall be made, pavement thickness test shall be made by the ENGINEER or his authorized representative unless otherwise specified in the special provisions or in the plans. The number and location of tests shall be at the discretion of the ENGINEER. The cost for the initial pavement thickness test shall be at the expense of the ENGINEER. In the event a deficiency in the thickness of pavement is revealed during normal testing operations, subsequent tests necessary to isolate the deficiency shall be at the CONTRACTOR's expense. The cost for the additional coring test shall be at the same rate charged by commercial laboratories.

I. Roadway Density

1. Roadway density shall meet requirements as outlined in the follows. One density test will be taken every 1000' which ever is less or as directed by the Engineer. The density shall be within the limits of max 98% and min 91%. The QC/QA target density will be 96%. If the first density test fails and additional four will be taken as directed by the Engineer. When the average of five densities tests results fail to meet the specification the asphalt shall be removed and replaced to meet specification requirements as ordered by the ENGINEER.

#### PART 4 - MEASUREMENT AND PAYMENT

##### 4.01 INCIDENTAL WORK:

- A. Prime coat, anti-stripping compound, where used and tack coat shall not be measured for direct payment, but shall be considered as subsidiary work pertaining to the placing of asphaltic mixtures of the contract price.

##### 4.02 MEASUREMENT:

- A. Hot-mix asphalt concrete material shall be measured by the ton of 2,000 pounds or by the square yard of the type or types used in the completed and accepted work or as shown on the bid proposal form. Should no item be provided in bid proposal form, all work shall be subsidiary to all the items of the bid.
- B. Weight shall be determined by a certified scale approved by the OWNER and recorded serially numbered weight tickets, identifying the vehicle and presented to the ENGINEER's representative on the job.

##### 4.03 PAYMENT:

- A. Work performed and materials furnished, as prescribed by this item, measured as provided herein, shall be paid at the unit bid price per ton or square yard for the type or types of hot mix asphalt concrete pavement shown on the proposal.
- B. Unit bid price shall be payment in full for quarrying; furnishing all materials; for all heating; mixing; hauling; cleaning existing base course or pavement; placing asphaltic mixtures; rolling and finishing; and for all labor, tools, equipment and incidentals necessary to complete the work, including the work and materials involved in the application of prime coat and tack coat.

END OF SECTION

**Project Number:** BORDER COLONIA ACCESS PROGRAM

**County:** HIDALGO COUNTY PRECINCT #3

**Highway:** VARIOUS SUBDIVISIONS

## **ITEM 400**

### **EXCAVATION AND BACKFILL FOR STRUCTURES**

**400.1. Description.** This Item shall govern for the excavation, bedding, backfill and/or portland cement stabilized backfill required for the construction of all structures, except drilled shafts. This Item shall also govern for any necessary sloping, pumping or bailing, for drainage, and for all sheeting and bracing of excavation walls up to five (5) feet in depth. Excavation greater than five (5) feet in depth shall be protected as specified in Item 402, "Trench Excavation Protection" or Item 403, "Temporary Special Shoring." Unless otherwise provided, the work included herein shall provide for the removal of old structures or portions thereof (abutments, wingwalls, piers, house foundations, old sewers, sewer appurtenances, etc.), trees and all other obstructions to the proposed construction, the blocking of the ends of abandoned sewers cut and left in place, and the protection of existing utilities. Also governed by this Item are the cutting and restoration of pavement and base courses, the construction and removal of any required cofferdams, the hauling and disposition of surplus materials and the bridging of trenches and other provisions for maintenance of traffic or access.

#### **400.2. Excavation.**

**(1) General.** Excavation shall conform to the lines and grades shown on the plans or as directed by the Engineer.

When trench and/or negative projecting conditions for concrete pipe culverts are required by design, an excavation diagram will be shown on the plans. These limits of excavation shall not be exceeded.

**(a) Disposal of Excavation.** All materials from excavation operations not required for backfilling and that are considered satisfactory, may be placed in embankment in accordance with Item 132, "Embankment." All excess material or material not satisfactory for use in embankment will become the property of the Contractor. All surplus material shall be removed from the work site promptly following the completion of the portion of the structure involved and disposed of in a manner satisfactory to the Engineer.

Whenever excavation is made for installing structures across private property or beyond the limits of the embankment, the top soil removed in the excavation shall be kept separate and replaced, as nearly as feasible, in its original position, and the entire area involved in the construction operations shall be restored to a condition acceptable to the Engineer.

**(b) Excavation in Streets.** Where structures are installed in streets, highways or other paved areas, the work shall include the cutting of pavement and base to neat lines and the restoration of pavement structure after structural excavation and backfill are completed. The type and thickness of replacement materials shall be as shown on the plans. Any work done or any damage to base and/or pavement incurred outside the limits shown on the plans or authorized by the Engineer, will not be measured for payment, but shall be restored at the Contractor's expense.

**Project Number:** BORDER COLONIA ACCESS PROGRAM

**County:** HIDALGO COUNTY PRECINCT #3

**Highway:** VARIOUS SUBDIVISIONS

Maintenance and control of traffic shall be in accordance with the approved traffic control plan and Manual on Uniform Traffic Control Devices.

**(c) Protection of Utilities.** The Contractor shall conduct his work with a minimum disturbance of existing utilities and it shall be his responsibility to coordinate all work in or near the utilities with the utility owners. The Contractor shall inform utility owners sufficiently in advance of his operations to enable them to identify and locate, reroute, provide temporary detours, or to make other adjustments to utility lines in order that work may proceed with a minimum of delay. The Contractor shall cooperate with all utility owners concerned for any utility adjustments necessary.

Particular care shall be exercised to avoid the cutting or damaging of underground utility lines that are to remain in place. Such lines, if damaged shall be restored promptly and shall be handled in accordance with Article 7.11. When active sanitary sewer lines are cut during excavation operations, temporary flumes shall be provided across the excavation, while open, and the lines shall be restored when the backfilling has progressed to the original bedding lines of the cut sewer.

**(d) Removing Old Or Abandoned Structures.** When old or abandoned structures or foundations are encountered in the excavation, such obstructions shall be removed for the full width of the excavation and to a depth of one (1) foot below the bottom of the excavation. When old inlets or manholes are encountered and no plan provision is made for adjustment or connection to the new structures, such manholes and inlets shall be removed completely to a depth one (1) foot below the bottom of the excavation. In each instance, the bottom of the excavation shall be restored to grade by backfilling and compacting by the methods provided hereinafter for backfill. Where the excavation cuts through abandoned sewers, these sewers shall be removed as required to clear the new structure and plugged in a manner approved by the Engineer.

**(e) Dewatering Of Excavation Area.** Structures shall not be constructed or laid in the presence of water unless approved by the Engineer. Setting of precast members, placement of concrete, or pipe placing operations shall be performed on a dry firm bed. This shall be accomplished by removal of water from the surface of the bed by bailing, pumping, wellpoint installation, deep wells, french drains, or any other method approved by the Engineer.

For foundations placed in the presence of water, when approved by the Engineer, pumping or bailing from the interior of any foundation enclosure shall be done in a manner which precludes the possibility of movement of water through or alongside any concrete being placed. No pumping or bailing will be permitted during the placing of structural concrete, or for a period of at least 36 hours thereafter, unless from a suitable sump separated from the concrete work. Pumping or bailing during placement of seal concrete shall be only to the extent necessary to maintain a static head of water within the cofferdam. Pumping or bailing to dewater a sealed cofferdam shall not be started until the seal has aged at least 36 hours.

In the event that the excavation cannot be dewatered to the point where the subgrade is free of mud, or it is difficult to keep the reinforcing steel clean in cast-in-

**Project Number:** BORDER COLONIA ACCESS PROGRAM

**County:** HIDALGO COUNTY PRECINCT #3

**Highway:** VARIOUS SUBDIVISIONS

place structures, a special material shall be used in the bottom of the excavation. Such special material shall be a minimum depth of three (3) inches and shall consist of a lean concrete mixture (not less than three (3) sacks of cement per cubic yard), or other material approved by the Engineer.

**(2) Bridge Foundations and Retaining Walls.** To determine the adequacy of a proposed foundation, the Engineer may require the Contractor to make soundings or take cores to determine the character of the subgrade materials. The maximum depth of soundings or cores will not exceed five (5) feet below the proposed footing grade.

Care shall be taken not to disturb the material below the bottom of footing grade. Backfilling in a foundation to compensate for excavation which has extended below grade will not be permitted. Such areas below grade shall be filled with concrete at the time the footing is placed. The additional concrete involved shall be at the Contractor's expense.

Unless otherwise required herein or on the plans, rock or other hard foundation material shall be free from all loose material, clean, and cut to a firm surface which may be level, stepped, or serrated, as directed by the Engineer. All seams shall be cleaned out and filled with concrete at the time the footing is placed.

When the material encountered at footing grade of a retaining wall, bridge bent or pier is found to be partially of rock or incompressible material and partially of a compressible material, the foundation shall not be placed until the Engineer has inspected the footing and authorized necessary changes to provide a uniform bearing condition.

**(3) Culverts.** For all single and multiple box culverts, pipe culverts, pipe arch culverts, long span structural plate structures, box sewers, and pipe sewers where the soil encountered at established footing grade is an unstable or incompressible material, the following procedure shall be used unless other methods are called for on the plans:

Unstable material shall be removed to a depth not to exceed two (2) feet below the footing of the structure unless additional depth is authorized by the Engineer. All soil removed shall be replaced with stable material in uniform layers not to exceed eight (8) inches in depth (loose measurement). Each layer shall have sufficient moisture to be compacted by rolling or tamping as required to provide a stable foundation for the structure.

When it is not feasible to construct a stable footing as outlined above, the Contractor shall use special materials, such as flexible base, cement stabilized base, cement stabilized backfill or other material, as directed by the Engineer. This work will be paid for as provided in Article 400.8. Special material used, or additional excavation made, for the Contractor's convenience to expedite the work, will be at the Contractor's expense.

When the material encountered at the footing grade of a structure is found to be rock, partially rock or other incompressible material, the incompressible material shall be removed to a depth of six (6) inches below the footing grade and backfilled

**Project Number:** BORDER COLONIA ACCESS PROGRAM

**County:** HIDALGO COUNTY PRECINCT #3

**Highway:** VARIOUS SUBDIVISIONS

with a compressible material approved by the Engineer and compacted in accordance with Article 400.5.

**(4) Trench.** Unless otherwise shown on the plans, all sewer pipe structures shall be constructed in an open cut with vertical sides to a point one (1) foot above the pipe. When site conditions or the plans do not prohibit the sloping of the cut, the excavation one (1) foot above the pipe may be stepped and/or the sides laid back to a stable slope. Required vertical sides shall be sheeted and braced when necessary to maintain the required vertical excavation throughout the construction period.

For all pipe sewers to be constructed in fill above natural ground, the embankment shall first be constructed to an elevation not less than one (1) foot above the top of the pipe, after which excavation for the pipe shall be made as noted above.

Unstable or incompressible material shall be removed in accordance with Subarticle 400.2.(3). For unstable trench conditions requiring outside forms, seals, sheeting and bracing, or where ground water is encountered, any additional excavation and backfill required shall be done at the Contractor's expense for trenches up to five (5) feet in depth.

**400.3. Cofferdams.** The term cofferdam designates any temporary or removable structure constructed to hold the surrounding earth, water, or both out of the excavation, whether the structure is formed of soil, timber, steel, concrete, or a combination of these. The "cofferdam" shall also include the use of pumping wells or well points used for the same purpose. The cost of cofferdams shall be included in the price bid for excavation except where temporary special shoring is shown on the plans to provide excavation protection.

For sheet pile or other types of cofferdams which require internal bracing, the Contractor shall submit details and design calculations bearing the seal of a Registered Professional Engineer for review. The maximum stresses shall not exceed 125 percent of the working allowable stresses used by the Department for the design of structures. The interior dimensions of cofferdams shall provide sufficient clearance for the construction, inspection (inside and outside), and removal of any required forms and to permit pumping outside the forms. In general, sheet pile cofferdams shall extend well below the bottom of the footings and any concrete seal and shall be well braced and as watertight as practicable.

Concrete for foundation seals, unless otherwise specified shall be Class E concrete in accordance with Item 421, "Portland Cement Concrete." The concrete seal shall be placed in accordance with Item 420, "Concrete Structures." Seal concrete when authorized by the Engineer will be paid for as provided in the various bid items. If no direct method of payment is provided in the contract for seal concrete, the work will be measured and paid for in accordance with Article 4.3. Seal placed for the convenience of the Contractor will be at the Contractor's expense.

When the Engineer judges it to be impractical to dewater a cofferdam and a concrete seal is to be placed around piling driven therein, the excavation shall be deep enough to allow for swell of the material during pile driving operations. After driving the piling, all swelling material shall be removed to the bottom of the seal grade. Where it is possible to dewater the cofferdam without placing a seal, the foundation material shall be removed to exact footing grades after piling are driven. Backfilling a foundation to compensate for

**Project Number:** BORDER COLONIA ACCESS PROGRAM

**County:** HIDALGO COUNTY PRECINCT #3

**Highway:** VARIOUS SUBDIVISIONS

excavation which has been extended below grade will not be permitted. Such areas below grade shall be filled with concrete at the time the seals or footings are placed. The additional concrete quantities necessary to compensate for excavation below grade shall be at the Contractor's expense.

Unless otherwise provided, cofferdams shall be removed by the Contractor after the completion of the substructure without disturbing or damaging the structure.

**400.4. Shaping and Bedding.** For precast pipe and box sections, the excavation shall be undercut a minimum depth sufficient to accommodate the class of bedding indicated on the plans and conforming to the bedding requirements of this Item. Where cement stabilized backfill is indicated on the plans, the excavation shall be undercut a minimum of four (4) inches and backfilled with stabilized material to support the pipe at the required grade.

**Project Number:** BORDER COLONIA ACCESS PROGRAM

**County:** HIDALGO COUNTY PRECINCT #3

**Highway:** VARIOUS SUBDIVISIONS

#### **400.5**

Three classes of bedding for trench or embankment conditions are shown in Figures 1, 2, and 3. Bedding shall be in accordance with Class C bedding unless otherwise shown on the plans. The Engineer may require the use of a template to secure reasonably accurate shaping of the foundation material.

#### **400.5. Backfill.**

**(1) General.** As soon as practical, all portions of the excavation not occupied by the permanent structure shall be backfilled. Backfill material may be obtained from excavation or from other sources. Backfill material shall be free from stones of such size as to interfere with compaction; free from large lumps which will not break down readily under compaction; and free from frozen lumps, wood, or other extraneous material.

Backfill which will not support any portion of the completed roadbed or embankment shall be placed in layers not more than 10 inches in depth (loose measurement). Backfill which will support any portion of the roadbed or embankment shall be placed in uniform layers not to exceed eight (8) inches in depth (loose measurement). Each layer of backfill shall be compacted to a density comparable with the adjacent undisturbed soil or as shown on the plans.

Each layer of backfill material, if dry, shall be wetted uniformly to the moisture content required to obtain a density comparable with the adjacent undisturbed soil or as shown on the plans and shall be compacted to that density by means of mechanical tamps or rammers. The use of rolling equipment of the type generally used in compacting embankments will be permitted on portions which are accessible to such equipment.

When tamping equipment is furnished which, when proven to the satisfaction of the Engineer, will adequately compact the backfill material to the density required, the eight (8) inch and 10 inch lifts (loose measurement) specified above may be increased to lifts not to exceed 12 inches.

Cohesionless materials, such as sand, may be used for general backfilling purposes. Compaction of cohesionless materials shall be done with vibratory equipment, water ponding or a combination thereof.

**(2) Bridge Foundations, Retaining Walls, And Culverts.** No backfill shall be placed against any structure until the concrete has reached the minimum flexural strength required in Item 421, "Portland Cement Concrete."

The material used for backfilling shall be free of any appreciable amount of gravel or stone particles more than four (4) inches in greatest dimension and shall be of a gradation that permits thorough compaction. The use of rock or gravel mixed with soil will be permitted, provided the percentage of fines is sufficient to fill all voids and insure a uniform and thoroughly compacted mass of proper density.

**Project Number:** BORDER COLONIA ACCESS PROGRAM

**County:** HIDALGO COUNTY PRECINCT #3

**Highway:** VARIOUS SUBDIVISIONS

When the excavation has been made through a hard material resistant to erosion, the Engineer may require the backfill around piers and in front of abutments and wings to be of stone or lean concrete. Unless otherwise provided, such backfill will be measured and paid for as extra work in accordance with Article 4.3.

Embankment which is too close to a structure to permit compaction by the use of the blading and rolling equipment used on adjoining sections of embankment, shall be placed and compacted in accordance with Subarticle 400.5(1). Mechanical tamps or rammers shall be required when the structure being backfilled could sustain damage from other compacting operations.

Care shall be taken to prevent any wedging action of backfill against the structure, and the slopes bounding the excavation shall be stepped or serrated to prevent such action. Backfill placed around piers shall be deposited uniformly.

**(3) Pipe.** After the bedding and pipes have been installed as required, the selected backfill materials shall be brought to proper moisture condition, placed along both sides of the pipe equally, in uniform layers not exceeding eight (8) inches in depth (loose measurement), and each lift thoroughly compacted mechanically. Special care shall be taken to secure thorough compaction of the materials placed under the haunches of the pipe and to prevent damage or displacement of the pipe. Filling and/or backfilling shall be continued in this manner to the elevation of the top of the pipe. Backfill above the top of the pipe shall be placed and compacted in accordance with Subarticle 400.5(1). During construction, protection of the pipe shall be in accordance with the pertinent pipe item. Pipe damaged by the Contractor during construction shall be replaced at the Contractor's expense or repaired to the satisfaction of the Engineer.

The Engineer may reject any material containing more than 20 percent by weight of material retained on a three (3) inch sieve, or material excavated in such a manner as to produce large lumps not easily broken down or which cannot be spread in loose layers. In general, material excavated by means of a trenching machine will meet the requirements above, provided large stones are not present.

Where sewers extend beyond the toe of slope of the embankment and the depth of cover provided by backfill to the original ground level is less than the minimum required by the specifications for the type of pipe involved, additional material shall be placed and compacted, as herein specified for backfill outside the limits of the roadbed, until this minimum cover has been provided.

**400.6. Cement Stabilized Backfill.** When shown on the plans, the excavation shall be backfilled to the elevations shown with cement stabilized backfill. Unless otherwise shown on the plans, cement stabilized backfill shall contain aggregate, water and a minimum of seven (7) percent portland cement based on the dry weight of the aggregate, in accordance with Test Method Tex-120-E. Aggregate shall be as shown on the plans or as approved by the Engineer.

Cement stabilized backfill below the top of sewers, manholes, inlets, or other structures shall be placed equally along all sides of the structure so as to prevent strain on or displacement of the structure. Cement stabilized backfill shall be placed in a manner that will completely fill all voids in the trench. Should compaction be required to fill all voids, hand operated tampers may be used.

**Project Number:** BORDER COLONIA ACCESS PROGRAM

**County:** HIDALGO COUNTY PRECINCT #3

**Highway:** VARIOUS SUBDIVISIONS

**400.7. Measurement.** Excavation and backfill will be measured by the cubic yard. Cutting and restoring of pavement will be measured by the square yard.

This is a plans quantity measurement Item and the quantity to be paid for will be that quantity shown in the proposal and on the "Estimate and Quantity" sheet of the contract plans, except as may be modified by Article 9.8. If no adjustment of quantities is required, additional measurements or calculations will not be required.

Unless otherwise shown on the plans, structural excavation for pipe headwalls, inlets, manholes, culvert widening (extensions) 15 feet or less in length, bridge abutments, retaining walls and side road and private entrance pipe culverts will not be measured but shall be considered subsidiary to the various bid items.

For culvert widening (extensive) greater than 15 feet, quantities for structural excavation will be shown on the plans.

Structural excavation will be measured by the cubic yard computed by the method of average end areas using the following limits to establish templates for measurement:

(1) For all excavation requiring measurement, except that required for the barrels of pipe culverts; for structural plate structures no material outside of vertical planes one (1) foot beyond the edges of the footings and parallel thereto will be included, unless otherwise shown on the plans. When the plans provide the Contractor the option of cast-in-place or precast boxes, measurement will be based on the cast-in-place option.

(2) For pipes 42 inches or less in nominal or equivalent diameter, no material outside of vertical planes one (1) foot beyond the horizontal projection of the outside surfaces of the pipe and parallel thereto will be included. For pipes more than 42 inches in nominal or equivalent diameter, no material outside of vertical planes located two (2) feet beyond the horizontal projection of the outside surfaces of the pipe and parallel thereto will be included. Excavation for pipes shall be measured between the extreme ends of the completed structure, including any end appurtenances, as shown on the plans and from centerline to centerline of inlets, manholes, etc., therein. When excavation for appurtenances is measured for payment, the limits of excavation for the pipes shall not overlap those of the appurtenances.

(3) For structural plate structures no material outside of vertical planes three (3) feet beyond the horizontal projection of the outside surfaces of the structure(s) and parallel thereto will be included. When the quality of the existing soil or embankment is less than that of the proposed backfill material, the excavation shall be extended for measurement to vertical planes located at one-half of the span beyond the horizontal projection of the outside surfaces of the structure(s) and parallel thereto.

**Project Number:** BORDER COLONIA ACCESS PROGRAM

**County:** HIDALGO COUNTY PRECINCT #3

**Highway:** VARIOUS SUBDIVISIONS

(4) If a cofferdam is used, the limitations of Subarticle 400.7.(1) shall apply just as if no cofferdam were used. Excavation quantities for foundations shown on the plans and in the proposal where cofferdams are required shall be considered as final quantities and no further measurement will be made.

(5) Where excavation, in addition to that allowed for the footings, is required for other portions of the structure, such as for the cap, cross strut, or tie beam of a pier or bent or for the superstructure, measurement for such additional excavation will be limited laterally by vertical planes one (1) foot beyond the face of the member and parallel thereto and vertically to a depth of one (1) foot below the bottom of such member.

(6) No measurement will be made of any excavation necessary for placing forms or falsework except as allowed by the above conditions.

(7) At all structure sites except at culverts and trench excavations, the measurement of structural excavation will include only material below or outside the limits of the completed road or channel excavation.

Trench excavation in fill above natural ground, as specified in Subarticle 400.2.(4), will be measured for payment. Quantities will include that area as specified in Subarticle 400.7.(2) plus one (1) foot above the top of the pipe, regardless of the height of fill previously made.

(8) Excavation required for shaping the slopes of header banks which were built by prior contract and upon which riprap is to be placed will be measured as "Structural Excavation, (Riprap)."

(9) For all culverts, except for side road and private entrance culverts, all excavation within the limits of the structure and below or outside the limits of the completed roadway excavation, will be measured as culvert excavation. Where the overall normal width of the culvert is 12 feet or less, measurement will be as "Structural Excavation, Culvert, Small." Where the overall normal width of the culvert exceeds 12 feet, measurement will be as "Structural Excavation, Culvert, Large."

(10) Where excavation diagrams are shown on the plans, they shall take precedence over these provisions.

**Project Number:** BORDER COLONIA ACCESS PROGRAM

**County:** HIDALGO COUNTY PRECINCT #3

**Highway:** VARIOUS SUBDIVISIONS

(11) Measurement will not include materials removed below footing grades to compensate for anticipated swelling due to pile driving, nor will it include material required to be removed due to swelling beyond the specified limits during pile driving operations.

(12) Measurement will not include additional volume caused by slips, slides, cave-ins, silting, or fill material resulting from the action of the elements or the Contractor's operation.

(13) Where rock, or other incompressible or unstable material is undercut to provide a suitable foundation for pipe or box sections, such material below grade, which is directed by the Engineer to be removed, will be measured for payment.

(14) No allowance will be made for any variance from plan quantity incurred by an alternate bid.

(15) Additional measurement will be made of the volume of excavation involved in the lowering or raising of the elevation of a footing, foundation, or structure unit, when such grade change is authorized by the Engineer.

(16) Cement stabilized backfill will be measured in accordance with the backfill diagram shown on the plans. The quantity of "Cement Stabilized Backfill" shown on the plans shall be considered as final quantities and no further measurement will be required. Changes in alignment or grade as authorized by the Engineer will be measured for payment.

(17) The work to be done in the cutting and restoring of pavement will be measured in accordance with the dimensions shown on the plans. The excavation below the pavement and/or base shall be measured as structural excavation of the pertinent type.

**400.8. Payment.** The work performed and materials furnished in accordance with this Item and measured as provided under "Measurement" will be paid for at the unit price bid for "Structural Excavation," "Structural Excavation (Bridge)," "Structural Excavation (Culvert, Small)," "Structural Excavation (Culvert, Large)," "Structural Excavation (Trench)," "Structural Excavation (Riprap)," "Cement Stabilized Backfill" and "Cutting and Restoring Pavement."

Payment for removal and replacement of unstable or incompressible material below the footing grades of culverts as provided for in Subarticle 400.2.(3) will be made as follows:

When the plans specify or when the Engineer directs the use of special materials such as flexible base, cement stabilized base, cement stabilized backfill or other special material, payment for excavation below the footing grades shall be made at the unit price bid for "Structural Excavation" of the pertinent type. Payment for furnishing, hauling, placing and compacting the flexible base, cement stabilized base, cement stabilized backfill or other special materials will be made at the unit price bid for these items in the contract or in accordance with Article 4.3. in cases where the required material is not a bid item.

**Project Number:** BORDER COLONIA ACCESS PROGRAM

**County:** HIDALGO COUNTY PRECINCT #3

**Highway:** VARIOUS SUBDIVISIONS

Where special materials are not required or specified, payment for the removal and replacement of unstable and/or incompressible material will be made at a price equal to 200 percent of the unit price bid per cubic yard for "Structural Excavation" of the pertinent type. This price shall be full compensation for removing the unstable or incompressible material, furnishing, hauling, placing and compacting suitable replacement material and for all labor, equipment, tools, and incidentals necessary to complete the work.

If no direct method of payment is provided in the contract for culvert excavation and no special materials are required or specified, the removal and replacement of unstable or incompressible material, when such work is authorized by the Engineer, will be measured and paid for at fifteen dollars (\$15.00) per cubic yard.

Should the Engineer deem it necessary to lower a bridge foundation to an elevation below the grade shown on the plans, such over excavation below plan will be paid for as "Structural Excavation" at an adjusted unit price as defined herein. Payment will be made at a unit price equal to 115 percent of the contract unit price bid for all over excavation where the revised footing grade does not vary from plan grade by more than five (5) feet.

Payment will be made at a unit price of 125 percent of the contract unit price bid for all over excavation where the revised grade varies from plan grade by more than five (5) feet but not in excess of 10 feet. In cases where the revised footing grade varies from plan grade by more than 10 feet, a supplemental agreement shall be prepared to establish a unit price with which to make payment for the over excavation.

No direct payment will be made for backfilling around structures. Payment for the backfilling and compacting of areas which were removed as structural excavation shall be included in the unit price bid for "Structural Excavation."

Unless otherwise shown on the plans, structural excavation which has been completed to the satisfaction of the Engineer, but not backfilled, a partial payment of 50 percent of the price bid will be made. The remaining amount will be paid upon the satisfactory completion of the backfilling.

This price shall be full compensation for all excavation, bedding, and backfill including placing, sprinkling and compaction of material; all soundings; cleaning and filling seams; constructing all cofferdams; all dewatering; and for furnishing all materials, hauling, labor, equipment, tools, sheeting and/or bracing of excavations up to and including five (5) feet in depth, pumps, drills, explosives, disposition of surplus material, cutting pavement and base to neat lines; and for incidentals necessary to complete the work, except that protection methods for excavations greater than five (5) feet in depth shall be measured and paid for as required under Item 402, "Trench Excavation Protection" or Item 403, "Temporary Special Shoring."

**Project Number:** BORDER COLONIA ACCESS PROGRAM

**County:** HIDALGO COUNTY PRECINCT #3

**Highway:** VARIOUS SUBDIVISIONS

## ITEM 402

### TRENCH EXCAVATION PROTECTION

**402.1. Description.** This Item shall govern for the excavation protection required for the trenches in excess of five (5) feet deep, including all additional excavation, backfill, pavement reconstruction and repair made necessary by the protection system, in accordance with this Item.

A trench shall be defined as a narrow excavation made below the surface of the ground. In general, the depth is greater than the width, but the width of a trench is not greater than 15 feet. If forms or other structures are installed or constructed in an excavation so as to reduce the dimension measured from the forms or structure to the side of the excavation to 15 feet or less (measured at the bottom of the excavation), the excavation is also considered to be a trench. In addition, "Trench Excavation Protection" will not be limited to these applications, but may be used wherever deemed expedient and proper to the ensuing work.

**402.2. Construction Methods.** Trench Excavation Protection shall be as required by the provisions of Part 1926, Subpart P-Excavations, Trenching, and Shoring of the Occupational Safety and Health Administration's Standards and Interpretations.

**402.3. Measurement.** This Item will be measured by the linear foot along the centerline of trench where the depth of trench exceeds five (5) feet.

**402.4. Payment.** The work performed and materials furnished in accordance with this Item and measured as provided under "Measurement" will be paid for at the unit price bid for "Trench Excavation Protection". This price shall be full compensation for all excavation and backfill; for furnishing, placing and removing all shoring, sheeting, or bracing; for dewatering or diversion of water; for all jacking and jack removal; and for all other labor, materials, tools, equipment and incidentals necessary to complete the work.

No payment will be made for excavation protection made necessary due to the selection of an optional design or sequence of work that creates the need for the protection system.

**Project Number:** BORDER COLONIA ACCESS PROGRAM

**County:** HIDALGO COUNTY PRECINCT #3

**Highway:** VARIOUS SUBDIVISIONS

## ITEM 464

### REINFORCED CONCRETE PIPE

#### 464.1.1. Description.

This Item shall govern for furnishing and installing all concrete pipe and materials and for constructing precast concrete pipe culverts or precast concrete sewer mains, laterals, stubs and inlet leads. The pipes shall be of the sizes, strengths and dimensions shown on the plans and shall include all connections to new or existing pipes, sewers, manholes, inlets, headwalls and other appurtenances and jointing materials as may be required to complete the work.

#### 464.2. Materials.

(1) **General.** Except as modified herein, precast reinforced concrete pipe shall conform to the design shown on the plans and to ASTM C76 or C655 for circular pipe; ASTM C506 for arch pipe or ASTM C507 for horizontal elliptical pipe.

All precast concrete pipe shall be machine made or cast by a process which will provide for uniform placement of the concrete in the form and compaction by mechanical devices which will assure a dense concrete. Concrete shall be mixed in a central batch plant or other approved batching facility from which the quality and uniformity of the concrete can be assured. Transit mixed concrete will not be acceptable for use in precast concrete pipe.

Unless otherwise shown on the plans, not more than two (2) holes may be placed in the top section of precast pipe for lifting and placing. The holes may be cast, cut, or drilled in the wall of the pipe. The holes shall not exceed three (3) inches in diameter at the inside surface of the pipe wall. Not more than one (1) longitudinal wire or two (2) circumferential wires may be cut per layer of reinforcing steel when locating lift holes in the pipe wall. After the pipe is in place, lift holes shall be filled with concrete or mortar or precast concrete plugs to the satisfaction of the Engineer.

The Contractor has the option of using portland cement or portland cement plus fly ash. When fly ash is used, then "cement" shall also be defined as "cement plus fly ash". "Cement plus fly ash" shall be composed of portland cement of the type specified and 20 to 35 percent fly ash by absolute volume. Type B fly ash shall not be used when Type II cement is shown on the plans. When portland cement is partially replaced, blended or otherwise modified by a pozzolan, the pozzolan is defined and limited to fly ash conforming to Department Materials Specification D-9-8900, "Fly Ash".

Copies of Departmental Materials Specifications are available from the Texas Department of Transportation, Division of Materials and Tests, 125 East 11th St., Austin, Texas 78701-2483.

**Project Number:** BORDER COLONIA ACCESS PROGRAM

**County:** HIDALGO COUNTY PRECINCT #3

**Highway:** VARIOUS SUBDIVISIONS

**(2) Design.** Circular pipe shall be of the class or D-load shown on the plans. Regardless of the design shown, the Contractor may furnish pipe to either ASTM C76 or ASTM C655 specifications. Table C outlines the class and D-load equivalents. For concrete pipe arch or elliptical pipe, the minimum design shall conform to Table A or B.

TABLE A \*

Arch Pipe

Design Size	Equiv. Dia. In.	Rise In.	Span In.
1	18	13 1/2	22
2	21	15 1/2	26
3	24	18	28 1/2
4	30	22 1/2	36 1/4
5	36	26 5/8	43 3/4
6	42	31 5/16	51 1/8
7	48	36	58 1/2
8	54	40	65
9	60	45	73
10	72	54	88

TABLE B \*

Horizontal Elliptical Pipe

Design Size	Equiv. Dia. In.	Rise In.	Span In.
1	18	14	23
2	24	19	30
3	27	22	34
4	30	24	38
5	33	27	42
6	36	29	45
7	39	32	49
8	42	34	53
9	48	38	60
10	54	43	68

\*Minimum height of cover required is one (1) foot.

\*Maximum height of cover is eight (8) feet.

TABLE C  
CIRCULAR PIPE  
(CLASS, D-LOAD EQUIVALENTS)

<b>Error! Reference source not found. C76</b>	<b>C655</b>
CLASS I	800D-LOAD
CLASS II	1000D-LOAD
CLASS III	1350D-LOAD
CLASS IV	2000D-LOAD
CLASS V	3000D-LOAD

Reinforced concrete pipe for jacking, boring or tunneling shall meet the requirements of the pertinent ASTM specification with the following additional requirements:

**Project Number:** BORDER COLONIA ACCESS PROGRAM

**County:** HIDALGO COUNTY PRECINCT #3

**Highway:** VARIOUS SUBDIVISIONS

The pipe shall have circular reinforcement and for 30 inch and larger diameters shall have an additional layer of Class III reinforcement, 12 inches long, extending into both the tongue and groove of the joint to within 3/4 inch of the end of the tongue and the groove. The minimum wall thickness shall be wall "B" for the diameter specified, unless special designs are required. The minimum concrete compressive strength for jacking and boring pipe shall be 5000 psi. Variations in the laying length of opposite sides shall not exceed 3/8 inch for pipe diameters 24 inches through 60 inches and 1/2 inch for pipe diameters 66 inches and larger. The maximum joint taper shall be 7 degrees for tongue and groove pipe and 2 degrees for O-ring gasket pipe. Pipe manufactured to these additional requirements shall be marked to identify pipe for jacking and boring.

The plans will provide a summary indicating the locations and length for all pipe. In addition, the diameter, required D-load and/or class for full circle pipe, and/or the design size for pipe arch or elliptical pipe will also be shown.

**(3) Physical Test Requirements.** The acceptability of the pipe shall be determined by the results of the physical tests outlined herein; by appropriate material tests required in ASTM C76, C506, C507, or C655; by absorption tests on selected samples from the wall of the pipe; and by inspection of the finished pipe to determine its conformance with the required design and its freedom from defects. Three-Edge Bearing tests shall be performed on one (1) pipe for each 100 pipe or fraction thereof of each design or shape, size, class or D-load for the load to produce a 0.01 inch crack and, at the discretion of the Engineer, the pipe may be tested to ultimate load.

As an alternate to the Three-Edge Bearing test, concrete pipe 60 inches in diameter and larger may be accepted on the basis of compressive strength of cores cut from the wall of the pipe. The manufacturer shall furnish facilities and personnel for taking the cores and determining the compressive strength of the samples. Three-Edge Bearing tests and core tests shall be in accordance with ASTM C497.

The manufacturer shall plug and seal coreholes in the pipe wall, after testing, in a manner satisfactory to the Engineer.

**(4) Marking.** The following information shall be clearly marked on each section of pipe:

**(a)** The class or D-load of pipe.

**(b)** The date of manufacture.

**Project Number:** BORDER COLONIA ACCESS PROGRAM

**County:** HIDALGO COUNTY PRECINCT #3

**Highway:** VARIOUS SUBDIVISIONS

(c) The name or trademark of the manufacturer.

(d) One end of each section of pipe with elliptical reinforcement shall be clearly marked during the process of manufacture or immediately thereafter on the inside and the outside of opposite walls to show the location of the "top" or "bottom" of the pipe as it should be installed, unless the external shape of the pipe is such that the correct position of the top and bottom is obvious. Marking shall be indented on the pipe section or painted thereon with waterproof paint.

(e) Pipe for jacking and boring shall be identified for the intended use.

**(5) Inspection.** The quality of materials, the process of manufacture, and the finished pipe shall be subject to inspection and approval by the Engineer at the pipe manufacturing plant. In addition, the finished pipe shall be subject to further inspection by the Engineer at the project site prior to and during installation.

**(6) Causes for Rejection.** Pipe shall be subject to rejection for failure to conform to any of the specification requirements. Individual sections of pipe may be rejected because of any of the following:

(a) Fractures or cracks passing through the shell, except for a single end crack that does not exceed the depth of the joint.

(b) Defects that indicate imperfect proportioning, mixing and molding.

(c) Surface defects indicating honeycombed or open texture.

(d) Damaged ends, where such damage would prevent making a satisfactory joint.

(e) Any continuous crack having a surface width of 0.01 inch or more and extending for a length of 12 inches or more, regardless of position in the wall of the pipe.

**(7) Repairs.** Pipe may be repaired if necessary, because of occasional imperfections in manufacture or accidental injury during handling and will be acceptable if, in the opinion of the Engineer, the repairs are sound, properly finished and cured, and the repaired pipe conforms to the requirements of the specifications.

**(8) Rejections.** All rejected pipe will be plainly marked by the Engineer by painting colored spots over the Division of Materials and Tests monogram on the inside wall of the pipe and on the top outside wall of the pipe. The painted spots shall be sufficient to identify the rejected pipe but no larger than four (4) inches in diameter. Rejected pipe shall not be defaced in any other manner. The Contractor shall remove the rejected pipe from the project and replace with pipe meeting the requirements of this Item.

**Project Number:** BORDER COLONIA ACCESS PROGRAM

**County:** HIDALGO COUNTY PRECINCT #3

**Highway:** VARIOUS SUBDIVISIONS

**(9) Jointing Materials.** Unless otherwise specified on the plans the Contractor shall have the option of making the joints using any of the materials described herein. For all jointing materials except mortar, the Contractor shall furnish the Engineer the Manufacturer's Certificate of Compliance.

**(a) Mortar.** Mortar for joints shall be in accordance with the section, "Jointing", of this Item.

**(b) Cold Applied, Plastic Asphalt Sewer Joint Compound.** This material shall consist of natural and/or processed asphalt base, suitable volatile solvents and inert filler. The consistency is to be such that the ends of the pipe can be coated with a layer of the compound up to one-half inch thick by means of a trowel. The joint compound shall cure to a firm, stiff plastic condition after application. The material shall be of a uniform mixture and any small separation occurring in the container shall be stirred to a uniform mix before use.

This material shall meet the following requirements when tested in accordance with Test Method Tex-526-C:

Asphalt Base, 100% - % Volatiles - % Ash, % by weight	28-45
Volatiles, 212 F Evaporation, 24 h, % by weight	10-26
Mineral Matter, determined as Ash, % by weight	30-55
Consistency, Cone Penetration, 150 q, 5 sec, 77 F	150-275

**(c) Rubber Gaskets.** These gaskets shall conform to ASTM C361 or C443. The design of the joints and permissible variations in dimensions shall be in accordance with ASTM C443. The Contractor shall furnish the Engineer the Manufacturer's Certificate of Analysis.

**(d) Cold Applied Preformed Plastic Gaskets.** Preformed plastic gaskets shall be suitable for sealing joints of tongue and groove concrete pipe. The gasket sealing the joint shall be produced from blends of refined hydrocarbon resins and plasticizing compounds reinforced with inert mineral filler and shall contain no solvents, irritating fumes or obnoxious odors. The gasket joint sealer shall not depend on oxidizing, evaporating, or chemical action for its adhesive or cohesive strength, and shall be supplied in extruded rope-form of suitable cross-section. The size of the plastic gasket joint sealer shall be in accordance with the manufacturer's

**Project Number:** BORDER COLONIA ACCESS PROGRAM

**County:** HIDALGO COUNTY PRECINCT #3

**Highway:** VARIOUS SUBDIVISIONS

recommendations and be of sufficient size to properly seal the joint. The plastic gasket joint sealer shall be so constructed as to provide evidence of proper installation either by means of "squeeze-out" of the gasket material on the inside or outside around the complete pipe joint circumference or by means of tabs, projections or other such indicators placed at established intervals around the circumference of the pipe joint. Plastic gasket joint sealers shall be Type 1 or Type 2. Type 1 gaskets shall meet the "squeeze-out" requirements and Type 2 gaskets shall meet the requirements for tabs, projections or other indicators. The gasket joint sealer shall be protected by a suitable wrapper designed that when removed, the jointing material maintains integrity.

The chemical composition of the gasket joint sealing compound for Type 1 and 2, as shipped, shall meet the following requirements:

COMPOSITION	TEST METHOD	ANALYSIS
Bitumen, Petroleum Plastic		
Content, % by weight	ASTM D4	50-70
Ash-Inert Mineral Matter, % by weight	Tex-526-C	30-50
Volatile Matter, 325 F, % by weight	Tex-506-C	2.0 max.

The gasket joint sealing compound when immersed for 30 days at ambient room temperature separately in five (5) percent solution of caustic potash; a five (5) percent solution of hydrochloric acid; a five (5) percent solution of sulfuric acid; and a saturated H<sub>2</sub>S solution, shall show no visible deterioration.

The physical properties of the gasket joint sealing compound as shipped shall meet the following requirements:

PROPERTY	TEST METHOD REQUIREMENT		
	Type 1	Type 2	
Ductility @ 77 F (cm), min.	Tex-503-C	5.0	5.0
Softening Point, F	Tex-505-C	275	275
Penetration			
32 F (300g) 60 sec., min.	Tex-502-C	65	
77 F (150g) 5 sec.	Tex-502-C	50-120	50-120
115 F (150g) 5 sec., max.	Tex-502-C	150	

**Project Number:** BORDER COLONIA ACCESS PROGRAM

**County:** HIDALGO COUNTY PRECINCT #3

**Highway:** VARIOUS SUBDIVISIONS

**464.3. Construction Methods.** The location of private driveway and side road pipe shall be constructed at locations shown on the plans or as directed by the Engineer.

Reinforced concrete pipe culverts and sewers shall be constructed in accordance with the plans and requirements of this Item.

(1) **Excavation.** All excavation shall be in accordance with the requirements of Item 400, "Excavation and Backfill for Structures", except where tunneling or jacking methods are shown on the plans or permitted by the Engineer.

(2) **Shaping and Bedding.** Shaping and bedding shall be in accordance with Item 400, "Excavation and Backfill for Structures".

(3) **Laying Pipe.** Unless otherwise authorized by the Engineer, the laying of pipe on the bedding shall be started at the outlet end with the spigot or tongue end pointing downstream and shall proceed toward the inlet end with the abutting sections properly matched, true to the established lines and grades. Where bell and spigot pipe are used, cross trenches shall be cut in the foundation to allow the barrel of the pipe to rest firmly upon the bedding. These cross trenches shall be not more than two (2) inches larger than the bell ends of the pipe. Proper equipment shall be provided for hoisting and lowering the sections of pipe into the trench without disturbing the bedding and the sides of the trench. The ends of the pipe shall be carefully cleaned before the pipe is placed. As each length of pipe is laid, the mouth of the pipe shall be protected to prevent the entrance of earth or bedding material. The pipe shall be fitted and matched so that when laid in the bed the pipe shall form a smooth, uniform conduit. When elliptical pipe with circular reinforcing or circular pipe with elliptical reinforcing is used, the pipe shall be laid in the trench in such position that the markings "Top" or "Bottom", shall not be more than five (5) degrees from the vertical plane through the longitudinal axis of the pipe.

Multiple installations of reinforced concrete pipe shall be laid with the center lines of individual barrels parallel. Unless otherwise shown on the plans, the following clear distances between outer surfaces of adjacent pipes shall be used.

Diameter 18"	24"	30"	36"	42"	48"	54"	60" to 84"
Clear 0'-9" Distance Between Pipes	0'- 11"	1'- 1"	1'- 3"	1'- 5"	1'- 7"	1'- 11"	2'-0"

**Project Number:** BORDER COLONIA ACCESS PROGRAM

**County:** HIDALGO COUNTY PRECINCT #3

**Highway:** VARIOUS SUBDIVISIONS

**(4) Jointing.**

**(a)** Joints sealed with portland cement mortar shall be made as follows:

Mortar shall consist of one (1) part cement, two (2) parts sand and sufficient water to make a plastic mix. The pipe ends shall be cleaned and wetted before making the joint. The lower half of the bell or groove and the upper half of the tongue or spigot shall be plastered with mortar. After the pipes are tightly jointed, mortar shall be packed into the joint from both inside and outside the pipe. The inside shall be finished smooth and flush with adjacent joints of pipe. Over the joint outside the pipe, a bead shall be formed at least one (1) inch on either side of the joint and of semicircular cross section for tongue and groove joints, but for bell and spigot joints, the mortar shall form a 45° fillet between the outer edge of the bell and the spigot. Mortar joints shall be cured by keeping the joints wet for at least 48 hours or until the backfill has been completed, whichever comes first. No jointing shall be done when the atmospheric temperature is at or below 40 F. Mortared joints shall be protected against freezing by backfilling or other approved methods for at least 24 hours.

No mortar banding on the outside of pipe will be required for driveway culverts.

At the Contractor's option, and with the approval of the Engineer, pipes which are large enough for a man to enter may be furnished with the groove not less than one-half of an inch and not more than three-fourths of an inch longer than the tongue. Such pipe may be laid and backfilled without mortar joints. Care shall be exercised to avoid displacing the joints during the backfilling operations. After the backfilling has been completed, the space between the end of the tongue and the groove on the interior of the pipe shall be cleaned of all foreign material, thoroughly wetted and filled with mortar around the entire circumference of the pipe and finished flush.

The Contractor shall make available for the use of the Engineer, an appropriate rolling device similar to an automobile mechanic's "Creeper" for conveyance through small size pipe structures.

Mortar joints will be required for irrigation wells, vents and similar vertical structures.

**(b)** Joints using Cold Applied, Plastic Asphalt Sewer Joint Compound shall be made as follows:

Both ends of the pipes shall be clean and dry. A one-half inch thick layer of the compound shall be troweled or otherwise placed in the groove end of the pipe covering not less than two-thirds of the joint face around the entire circumference. Next, the tongue end of the next pipe shall be shoved home with sufficient pressure to make a tight joint. After the joint is made any excess mastic projecting into the pipe shall be removed. Backfilling of

**Project Number:** BORDER COLONIA ACCESS PROGRAM

**County:** HIDALGO COUNTY PRECINCT #3

**Highway:** VARIOUS SUBDIVISIONS

pipe laid with asphalt mastic joints may proceed as soon as the joint has been inspected and approved by the Engineer. Special precautions shall be taken in placing and compacting backfill to avoid damage to the joints.

**(c)** Joints using Rubber Gaskets shall be made as follows:

Where rubber gasket pipe joints are required by the plans the joint assembly shall be made according to the recommendations of the gasket manufacturer. Water tight joints will be required when using rubber gaskets. Backfilling may begin when approved by the Engineer.

**(d)** Joints using Cold Applied Preformed Plastic Gaskets shall be made as follows:

Before laying the pipe in the trench, the plastic gasket shall be attached around the tongue or groove near the shoulder or hub of each joint in accordance with the gasket manufacturer's recommendations. The protective wrapper shall be removed and the gasket pressed firmly to the clean, dry surface of the pipe, as recommended by the manufacturer. The joint sealer must be placed in such a manner that no dirt or other deleterious materials will come in contact with the joint sealing material.

After the tongue is correctly aligned with the flare of the groove, the wrapper or wrappers on the gasket shall be removed and the pipe shall be pulled or pushed home with sufficient force to properly seal the joint. Any joint material pushed out into the interior of the pipe that would tend to obstruct the flow shall be removed. (Pipe shall be pulled home in a straight line with all parts of the pipe on line and grade at all times.) Backfilling of pipe laid with plastic gasket joints may proceed as soon as the joint has been inspected and approved by the Engineer. Special precautions shall be taken in placing and compacting backfill to avoid damage to the joints.

When the atmospheric temperature is below 60 F, plastic joint seal gaskets shall either be stored in an area warmed to above 70 F, or artificially warmed to this temperature in a manner satisfactory to the Engineer. Gaskets shall then be applied to pipe joints immediately prior to placing pipe in trench, followed by connection to previously laid pipe.

**(5) Connections and Stub Ends.** Connections of concrete pipe to existing pipes, pipe sewers or sewer appurtenances shall be as shown on the plan.

The bottom of existing structures shall be mortared or concreted if necessary to eliminate any drainage pockets created by the connections. Any damage to the existing structure resulting from making the connection shall be repaired by the Contractor, to the satisfaction of the Engineer, at the Contractor's expense.

**Project Number:** BORDER COLONIA ACCESS PROGRAM

**County:** HIDALGO COUNTY PRECINCT #3

**Highway:** VARIOUS SUBDIVISIONS

When concrete pipe is to be joined with existing aluminum pipe, portions of the aluminum pipe that are to be in contact with the concrete pipe, shall be insulated with a coating of bituminous material meeting the requirements of Article 460.7. The coating shall extend to a minimum distance of one (1) foot beyond the area of contact.

Unless otherwise shown in the plans, connections between concrete pipe and corrugated metal pipe shall be made with a suitable concrete collar having minimum thickness of four (4) inches.

Stub ends, for connections to future work not shown on the plans, shall be finished by installing watertight plugs into the free end of the pipe.

**(6) Backfilling.** After the pipe has been placed, bedded and jointed as specified, filling and/or backfilling shall be done in accordance with the applicable requirements of Item 400, "Excavation and Backfill for Structures". When mortar joints are specified, no fill or backfill shall be placed until the jointing material has been cured for at least six hours. Special precautions shall be taken in placing and compacting the backfill to avoid any movement of the pipe or damage to the joints. For all pipe structures where joints consist of materials other than mortar, immediate backfilling will be permitted.

**(7) Reuse of Appurtenances.** When existing appurtenances are specified on the plans for reuse, the portion to be reused shall be severed from the culvert and moved to the new position previously prepared by hoisting with a crane, rolling, or other approved methods. Connections shall conform to the requirements for joining sections of pipes, as designated herein or as shown on the plans. Any portion of the headwalls or pipe attached to the appurtenance damaged during the moving operations by the Contractor shall be restored to its original condition at the Contractor's expense. The Contractor may remove and dispose of the existing appurtenances and construct new appurtenances at his expense in accordance with the pertinent specifications and design shown on the plans or as furnished by the Engineer.

**(8) Protection of Pipe.** Unless otherwise shown on the plans or permitted in writing by the Engineer, no heavy earth moving equipment will be permitted to haul over the structure until a minimum of four (4) feet of permanent or temporary, compacted fill has been placed thereon. Pipe damaged by the Contractor's equipment shall be removed and replaced by the Contractor at the Contractor's expense.

#### **464.4.Measurement.**

This Item will be measured by the linear foot. Such measurement will be made between the ends of the pipe barrel along the flow line, exclusive of safety end treatments. Safety

**Project Number:** BORDER COLONIA ACCESS PROGRAM

**County:** HIDALGO COUNTY PRECINCT #3

**Highway:** VARIOUS SUBDIVISIONS

end treatments shall be measured in accordance with Item 467, "Safety End Treatment". Where spurs or branches, or connections to existing pipe lines are involved, measurement of the spur or new connecting pipe will be made from the intersection of the flow line with the outside surface of the pipe into which it connects. Where inlets, headwalls, catch basins, manholes, junction chambers, or other structures are included in lines of pipe, that length of pipe tying into the structure wall will be included for measurement but no other portion of the structure length or width will be so included.

For multiple pipes, the measured length will be the sum of the lengths of the barrels measured as prescribed above.

This is a plans quantity measurement Item and the quantity to be paid for will be that quantity shown in the proposal and on the "Estimate and Quantity" sheet of the contract plans, except as may be modified by Article 9.8. If no adjustment of quantities is required, additional measurements or calculations will not be required.

#### **464.5. Payment.**

The work performed and materials furnished in accordance with this Item and measured as provided under "Measurement" will be paid for at the unit price bid for "Reinforced Concrete Pipe" and "Reinforced Concrete Pipe (Sewers)" of the size and D-load or class specified; and "Reinforced Concrete Pipe (Arch)", "Reinforced Concrete Pipe (Elliptical)", "Reinforced Concrete Pipe (Arch) (Sewer)", and "Reinforced Concrete Pipe (Elliptical) (Sewer)" of the design specified.

This price shall be full compensation for furnishing, hauling, placing and joining of pipes; for cutting of skews or slopes, for all connections to new or existing structures; for moving and reusing appurtenances where required; for removing and disposing of portions of existing structures as required; and for all labor, tools, equipment and incidentals necessary to complete the work.

Excavation, bedding and backfill will be paid for in accordance with Item 400, "Excavation and Backfill for Structures".

**Project Number:** BORDER COLONIA ACCESS PROGRAM

**County:** HIDALGO COUNTY PRECINCT #3

**Highway:** VARIOUS SUBDIVISIONS

## ITEM 479

### ADJUSTING MANHOLES AND INLETS

**479.1. Description.** This Item shall govern for adjusting or capping of existing manholes or inlets as shown on the plans and in accordance with this Item or as directed by the Engineer. Subject to the approval of the Engineer, prefabricated metal extension rings may be furnished for the adjustment of manholes. Drainage junction boxes will be classified as manholes.

**479.2. Materials.** Manholes or inlet rings, plates, grates and covers, and brick in good condition, removed from the manholes and inlets in the process of abandonment, capping or adjustment, may be reused. Additional materials when required shall conform to the pertinent provisions of Item 465, "Manholes and Inlets".

**479.3. Construction Methods.** Manholes or inlet rings, covers, plates, and grates shall be removed carefully and the contact areas shall be cleaned of all mortar and grease. Rings, covers, plates, or grates broken in the process of removal and cleaning shall be replaced by the Contractor at his expense.

When prefabricated metal extension rings are furnished, they may be either single piece or multiple piece as necessary for the amount of adjustment. They shall be installed in accordance with the manufacturer's instructions.

If the adjustment involves lowering the top of a manhole or inlet, a sufficient depth of brick courses or concrete shall be removed to permit reconstruction on a batter not exceeding one (1) inch horizontal to two (2) inches vertical. In the case of brickwork, the mortar shall be cleaned from the top course of brick remaining in place and from all brick to be reused and the manhole or inlet rebuilt to the original top dimensions. The manhole or inlet ring, cover, plate, or grate shall then be installed with the top conforming to the proposed new surface.

If the adjustment involves raising the elevation of the top of manhole or inlet, the top surface of brick or concrete shall be cleaned and built up vertically to the new elevation using new brick, brick salvaged from other manhole or inlet adjustments, concrete rings or Class "A" concrete, and the ring, cover, plate, or grate installed with the top conforming to the proposed new surface.

When capping of an inlet or manhole is required, it shall be removed to a minimum of one (1) foot below subgrade elevation or as otherwise indicated on the plans, and capped as shown on the plans.

All work shall be in accordance with Item 465, "Manholes and Inlets".

Excavation and backfill shall conform to Item 400, "Excavation and Backfill for Structures".

**479.4. Measurement.** Manholes or inlets completely adjusted, or capped as prescribed above, will be measured as each manhole or inlet adjusted.

**Project Number:** BORDER COLONIA ACCESS PROGRAM

**County:** HIDALGO COUNTY PRECINCT #3

**Highway:** VARIOUS SUBDIVISIONS

**479.5. Payment.** The work performed and materials furnished in accordance with this Item and measured as provided under "Measurement" will be paid for at the unit price bid for "Adjusting Manholes", "Adjusting Inlets", or "Adjusting Manholes and Inlets". This price shall be full compensation for furnishing all required materials, including backfill as required, excavation, tools, labor, equipment, and incidentals required to complete the work..

**Project Number:** BORDER COLONIA ACCESS PROGRAM

**County:** HIDALGO COUNTY PRECINCT #3

**Highway:** VARIOUS SUBDIVISIONS

## **ITEM 502**

### **BARRICADES, SIGNS AND TRAFFIC HANDLING**

#### **502.1.Description.**

This Item shall govern for providing, installing, moving, replacing, maintaining, cleaning and removing upon completion of work, all barricades, signs, cones, lights and other such type devices and of handling traffic as indicated on the plans or as directed by the Engineer.

#### **502.2.Construction Methods.**

All barricades, signs and other types of devices listed above shall conform to details shown on the plans or those indicated in the Texas Manual on Uniform Traffic Control Devices (TMUTCD).

For this project a Traffic Control Plan (TCP), responsive to the TMUTCD, has been established by the Engineer. The Contractor may propose his own TCP. Contractor-proposed major modifications to the Traffic Control Plan shall bear the seal of a Registered Professional Engineer. If his plan is approved in writing by the Engineer, it may be used. Prior to beginning work, the Contractor shall designate, in writing, a competent person who will be responsible and available on the project site or in the immediate area to insure compliance with the TCP. The Engineer will designate a qualified Departmental person to observe implementation and who will have authority to assure compliance with the TCP.

All retro- reflective traffic control devices such as barricades, vertical panels, signs, etc., shall be maintained by cleaning, replacing or a combination thereof such that during darkness and rain the retro-reflective characteristics shall equal or exceed the retro-reflective characteristics of the standard reflective panels in the Engineer's possession.

#### **502.3.Measurement.**

This Item will be measured by the unit of measure "month" as indicated on the plans.

#### **502.4.Payment.**

The work performed and materials furnished in accordance with this Item and measured as provided under "Measurement" will be paid for at the unit price bid for "Barricades, Signs and Traffic Handling". This price shall be full compensation for furnishing all labor, materials, supplies, equipment and incidentals necessary to complete the work as specified.

Payment will be made on the following basis:

- (1) The total payment for this Item will not exceed 10 percent of the total contract amount prior to "Final Acceptance". The portion of the contract amount for this Item in excess of 10 percent of the total contract amount, less any adjustments as specified below, will be paid on the next monthly estimate cycle after the retainage estimate.

**Project Number:** BORDER COLONIA ACCESS PROGRAM

**County:** HIDALGO COUNTY PRECINCT #3

**Highway:** VARIOUS SUBDIVISIONS

(2) Payment for this Item will begin on the first payable monthly construction estimate after barricades, signs and traffic handling devices have been installed in accordance with the TCP and construction has begun.

(3) Monthly payment will be made each succeeding month for this Item provided the barricades, signs and traffic handling devices have been installed and maintained in accordance with the TCP until the contract amount for Barricades, Signs and Traffic Handling has been paid unless adjusted by paragraph (4).

(4) The quantity under this Item will not exceed the total plan quantity except when additional work is added by an approved field change or extra work order. Also when work is suspended for the convenience of the Department, through no fault of the Contractor, additional quantity may be paid when approved by field change.

(5) An overrun of the plan quantity for this Item will not be allowed for approving designs, testing, material shortages, closed construction seasons, curing periods, test periods, failure to complete the work prior to payment of the amount allowed by (1) and (3) above nor delays caused directly or indirectly by requirements of the contract.

(6) If the contract is completed prior to payment of the amount allowed by (1), (3) and (7), the balance due will be paid on the next monthly estimate cycle after the retainage estimate. When the plans establish pay items for particular work called for in the TCP and/or plans, that work will be measured and paid for under the governing items.

(7) If the Contractor fails, within the time frame established by the Engineer, to provide or properly maintain signs and barricades in compliance with the contract requirements, as determined by the Engineer, the Contractor will be considered in non-compliance with this Item and no payment will be made for this Item for the month(s) in question.

**Project Number:** BORDER COLONIA ACCESS PROGRAM

**County:** HIDALGO COUNTY PRECINCT #3

**Highway:** VARIOUS SUBDIVISIONS

## **ITEM 530**

### **INTERSECTIONS DRIVEWAYS AND TURNOUTS**

**530.1. Description.** Construct and pave intersections, driveways, and turnouts. Pave existing intersections, driveways, and turnouts. Intersections are considered to be areas off the travel lanes and shoulders of the Contract highway on the intersecting highway on the state system. The intersecting on-system highway work will be paid for under this Item only when shown on the plans. Driveways are defined as private (residential or commercial) and public (county road and city street) access areas off the travel lanes and shoulders. Turnouts include but are not limited to mailbox and litter barrel widenings.

**530.2. Materials.** Furnish materials that meet the following:

- Item 247, “Flexible Base”
- Item 260, “Lime Treatment (Road Mixed)”
- Item 263, “Lime Treatment (Plant Mixed)”
- Item 275, “Cement Treatment (Road Mixed)”
- Item 276, “Cement Treatment (Plant Mixed)”
- Item 292, “Asphalt Treatment (Plant Mix)”
- Item 316, “Surface Treatments”
- Item 330, “Limestone Rock Asphalt Pavement”
- Item 334, “Hot Mix–Cold Laid Asphalt Concrete Pavement”
- Item 340, “Dense-Graded Hot Mix Asphalt Concrete Pavement (Method)”
- Item 360, “Concrete Pavement”
- Item 421, “Hydraulic Cement Concrete”
- Item 440, “Reinforcing Steel.”

**530.3. Construction.** Construct and pave intersections, driveways, and turnouts, and pave existing intersections, driveways, and turnouts as shown on the plans or as directed. Place materials in accordance with construction Articles of pertinent Items. Provide uninterrupted access to adjacent property unless otherwise directed. Ensure that abrupt elevation changes in driveway or turnout areas that serve as sidewalks do not exceed 1/4 in. and that the sidewalk area cross slope does not exceed 2%. Ready-mix concrete and hand finishing will be permitted when concrete pavement is specified unless otherwise shown in the plans for intersections.

**Project Number:** BORDER COLONIA ACCESS PROGRAM

**County:** HIDALGO COUNTY PRECINCT #3

**Highway:** VARIOUS SUBDIVISIONS

**530.4. Measurement.** This Item will be measured by each intersection, driveway, or turnout, or by the square yard of the final pavement surface. When “Intersections, Driveways, and Turnouts” or “Driveways and Turnouts” are bid, measurement will be restricted to the square yard.

**530.5. Payment.** The work performed and materials furnished in accordance with this Item and measured as provided under “Measurement” will be paid for at the unit price bid for “Intersections,” “Driveways,” “Turnouts,” “Intersections, Driveways, and Turnouts,” or “Driveways and Turnouts” of the surface specified (Concrete, Asphaltic Concrete Pavement, or Surface Treatment).

This price is full compensation for furnishing and operating equipment; excavation and embankment; base and pavement materials; and labor, materials, tools, and incidentals. Drainage structures will be measured and paid for in accordance with the pertinent bid Items. Bonus and penalties for quality control and quality assurance (QC/QA) materials will not apply when payment for those materials is made under this Item.

## SPECIAL SPECIFICATION

### 5010

#### Construction Exits

1. **Description.** This Item shall govern for the materials to be furnished and for the installation, maintenance, and removal of construction exits of the type and dimensions shown on the plans. This item will be used temporarily during construction to control the tracking of sediment, mud, gravel, etc. from a construction site or other areas identified by the Engineer to a public right of way, street, sidewalk or parking area.
2. **Materials.** All materials shall meet the applicable requirements as indicated below for the specified type of construction exit.
  - (1) **Rock Construction Exit.** Rock used for long- and short-term construction exits shall consist of crushed stone. The aggregates shall be clean, hard, durable materials free from adherent coatings, salt, alkali, dirt, clay, loam, shale, soft or flaky materials, or organic and injurious matter.
  - (2) **Timber Construction Exit.** Timber for long-term construction exits shall consist of treated railroad ties and timbers. The railroad ties and timbers shall be treated to control rot and shall be No. 2 quality or better and free of large and loose knots. Timber shall be fastened with nuts and bolts or lag bolts all of which shall meet or exceed ASTM-A307.

Timber for short-term construction exits shall be treated to control rot and shall be No. 2 quality or better and free of large and loose knots. Plywood and/or pressed wafer board shall be a minimum of 1/2 inch thick.
  - (3) **Foundation Course.** The foundation course shall be flexible base, bituminous concrete, Portland cement concrete or other materials as approved by the Engineer.
3. **Construction Methods.** When tracking conditions exist, traffic shall not be allowed to cross or leave the construction site and move directly onto a public roadway, alley, sidewalk, parking area, or other right of way in areas other than at locations of construction exits. Construction exits can be either for long or short term use. Foundation courses, if needed, shall be used with the long-term construction exits.
  - (1) **Long-Term Construction Exit.** The exit shall be placed over a foundation course, if needed. The foundation course and/or compacted subgrade shall be properly graded to direct runoff from the construction exit to a sediment trap as shown on the plans or as directed by the Engineer. The exit shall normally be constructed a minimum length of 50 feet. The width shall be at least 14 feet for one-way traffic and 20 feet for two-way traffic but shall not be less than full width of all points of ingress and egress and shall be sufficient for all ingress and egress.
    - (a) **Type 1 Construction Exit.** This exit shall consist of open-graded crushed stone with a size of four to eight inches as shown on the plans. The depth of the aggregate shall not be less than eight inches.
    - (b) **Type 2 Construction Exit.** This exit shall be constructed of treated railroad ties and timbers as shown on the plans.
  - (2) **Short-Term Construction Exit.**
    - (a) **Type 3 Construction Exit.** This exit shall be either open-graded crushed stone with a size of two to four inches, or plywood or wafer board. This exit shall be used for daily operations when tracking conditions exist such as traffic crossing the construction site at locations where long-term exits are not practicable.

(b) **Type 4 Construction Exit.** This exit shall be as shown on the plans.

4. **Maintenance.** Exits shall be maintained in a condition which will prevent tracking or flowing of sediment onto public right of way. This may require periodic removal and replacement of stone or timber, or other material as conditions demand and repair and/or clean out of any measures used to trap sediment. Sediment spilled, dropped, washed or tracked onto public right of way shall be immediately removed by the Contractor and disposed of at an approved site and in a manner that will not contribute to additional siltation.

When necessary, wheels shall be cleaned to remove sediment prior to entrance onto public right of way. When washing is required, the construction exit shall be graded to drain into a sediment trap or sediment basin. Sediment shall be prevented from leaving the construction site.

The construction exits shall be removed promptly when directed by the Engineer. Discarded materials shall become the property of the Contractor for his disposal at an approved site. The area beneath the construction exit and any area damaged by the removal process shall then be stabilized by the Contractor using appropriate methods as approved by the Engineer. When the Special Specification, "Temporary Erosion, Sedimentation and Water Pollution Prevention and Control" is in the contract, stabilization shall be as defined in Subarticle 4.C. of that specification.

5. **Measurement.** Construction exits will be measured by the square yard of surface area of completed and accepted work.

Each time the Engineer directs that the construction exit (or a portion thereof) be removed or removed and replaced, it will be measured for payment.

6. **Payment.** The work performed and materials furnished in accordance with this Item and measured as provided under "Measurement", will be paid for at the unit price bid for "Construction Exits", of the type specified. This price shall be full compensation for securing and furnishing all materials, including all royalty and freight involved; for loosening, blasting, excavating, screening, crushing when required; for loading all materials; for hauling and delivering to the construction site; for spreading, mixing, blading, dragging, shaping and finishing; cleaning of wheels, when necessary; maintenance (except as shown below); and for all manipulations, labor, tools and incidentals necessary to complete the work.

When the Engineer directs that the construction exit (or a portion thereof) be replaced, payment will be made at the unit price bid for "Construction Exits (Remove and Replace)", of the type specified. This price shall be full compensation for the removal and replacement of the construction exit, and for all manipulations, labor, tools, equipment and incidentals necessary to complete the work.

The work performed in removing the exits as described under "Maintenance" and measured under "Measurement" will be paid for at the unit price bid for "Construction Exits (Remove)", of the type specified. This price shall be full compensation for removing, loading, hauling and disposing of all materials to an approved location; for repairing the entrance; and for all manipulations, labor, tools and incidentals necessary to complete the work.

Construction of sediment traps as well as the periodic removal of accumulated sediment deposits (as described under "Maintenance") used in conjunction with the construction exit will be measured and paid for under the pertinent bid items of the Special Specification, "Earthwork for Erosion Control".

Stabilization (as described under "Maintenance") will be measured and paid for under the various pertinent bid items.

## SPECIAL SPECIFICATION

5249

### Temporary Sediment Control Fence

1. **Description.** This Item shall govern for the materials to be furnished and for the installation, maintenance and removal of temporary sediment control fence of the dimensions shown on the plans. This Item will be used temporarily during construction to control erosion and sedimentation.
2. **Materials.**
  - (1) **Fence Description.** The fence shall be a net-reinforced fence, using woven geotextile fabric.
  - (2) **Fabric.** Fabric materials shall meet the requirements of Departmental Materials Specification D-9-6230, "Temporary Sediment Control Fence Fabric".
  - (3) **Posts.** Posts shall be a minimum of 48 inches long, essentially straight, and shall be wood or steel, unless otherwise shown on the plans. Soft wood posts shall be at least 3 inches in diameter or nominal 2 x 4 inches. Hardwood posts shall have a minimum cross-section of 1.5 x 1.5 inches. Steel posts shall be "T" or "L" shaped with a minimum weight of 1.3 pounds per linear foot.
  - (4) **Net Reinforcement.** Net reinforcement shall be galvanized welded wire mesh of a minimum 12.5-gauge wire or equal as approved by the Engineer with a maximum opening size of 2 x 4 inches and shall be at least 24 inches wide unless otherwise shown on the plans.
  - (5) **Staples.** Staples used to secure reinforcement and fabric to wood posts shall have a crown at least 3/4 inches wide and legs 1/2 inches long.
  - (6) **Used Materials.** Previously-used materials from other TxDOT projects, meeting the above requirements and when approved by the Engineer, may be used. Previously used materials from within the project shall be used whenever possible.
3. **Construction Methods.** The temporary sediment control fence shall be used during construction near the downstream perimeter of a disturbed area to intercept sediment from sheet flow. The fence may be incorporated into the erosion control measures used to control sediment in areas of higher flow. The fence installation methods shall be as specified below unless otherwise shown on the plans. The physical alignment and location of the fence shall be as shown on the plans or as directed by the Engineer.
  - (1) **Installation of Posts.** Posts shall be embedded to 18 inches deep, or adequately anchored if in rock, with a spacing of 6 to 8 feet, and installed on a slight angle toward the anticipated run-off source.
  - (2) **Fabric Anchoring.** Trenches shall be dug along the uphill side of the fence to anchor 6 to 8 inches of fabric. The trench shall have a minimum cross section of 6 x 6 inches. The fabric is against the side of the trench and approximately 2 inches of fabric is across the bottom in the upstream direction. The trench shall then be backfilled and hand tamped as approved by the Engineer.
  - (3) **Fabric Attachment.** The reinforcement shall be attached to the end posts, if wood, by staples, or if steel, by T-clips or sewn vertical pockets at a minimum of four (4) locations. The reinforcement shall be attached to each succeeding post as approved by the Engineer. The ends of successive reinforcement sheets or rolls shall be connected at a fence post at least six (6) times with hog rings.

The fabric shall be fastened to the top strand of reinforcement by hog rings or cord at a maximum spacing of 15 inches.

- (4) **Fabric Splices.** Splices shall occur at a fence post and shall have a minimum lap of 6 inches attached in at least six (6) places. Splices in concentrated flow areas will not be permitted.

When removing temporary sediment control fence that is suitable for relocation, the Contractor shall take all necessary measures to maintain the fabric in the best condition.

Requirements for installation of used temporary sediment control fence shall include:

- (1) Minimal or no visible signs of biodegradation (weak fibers)
- (2) No excessive patching every 15 to 20 linear foot.
- (3) Posts must not be bent and backing must not have holes.

4. **Maintenance.** The temporary sediment control fence shall be maintained in good condition (including staking, anchoring, tension adjustments, etc.) By the Contractor. All necessary work and materials to maintain the integrity of the fence, including keeping fabric free of accumulated silt, debris, etc., shall be provided until earthwork construction and permanent erosion control features are in place, and/or the disturbed area has been adequately stabilized. When the Special Specification, "Temporary Erosion, Sedimentation, and Water Pollution Prevention and Control", is in the contract, stabilization shall be as described in Subarticle 4.C. of that specification. The areas damaged by the removal process shall be stabilized by the Contractor using appropriate methods as approved by the Engineer.

Torn or punctured fabric shall be repaired by the placement of a patch consisting of an additional layer of fabric over the damaged area. The patch shall have a minimum overlap of 18 inches in all directions and be securely attached to the repaired fabric.

When the accumulated sediment deposit reaches a depth of approximately 6 inches, it shall be removed and disposed of at approved sites in a manner that will not contribute to additional siltation. If the structure ceases to function as intended, the Engineer may direct that the fence or portions thereof be replaced. Such replacement will be measured for payment.

5. **Measurement.** Temporary sediment control fence will be measured by the linear foot of fence, complete in place, measurement being made along the centerline of the top of the fence.

Each time the Engineer directs that the temporary sediment control fence (or portions thereof) be removed or replaced, it will be measured by the linear foot for payment.

6. **Payment.** The work performed and materials furnished in accordance with this Item and measured as provided under "Measurement", will be paid for at the unit price bid for "Temporary Sediment Control Fence". This price shall be full compensation for furnishing, placing and maintenance of the fence (except as shown below); for all required trenching, fence posts, fabric and backfill; and for all labor, tools, equipment and incidentals necessary to complete the work.

When the Engineer directs that the temporary sedimentation control fence installation (or portions thereof) be replaced, payment will be made at the unit price, bid for "Temporary Sediment Control Fence (Remove and Replace)". This price shall be full compensation for the removal and replacement of the fence installation and for all manipulations, labor, tools, equipment and incidentals necessary to complete the work.

No non-damaged material will be removed from the project until such time that no new installations or replacements will be required. All sound materials removed from project installations will be placed or stockpiled for project placement or replacement. No new material will be accepted when stockpiled material is available for use. The Contractor retains ownership of the stockpiled material.

The removal of accumulated sediment deposits, as described under "Maintenance", will be measured and paid for under the pertinent bid items of the Special Specification, "Earthwork for Erosion Control".

The work performed in the final removal of the temporary sediment control fence installation as described under "Maintenance" and measured under "Measurement" will be paid for at the unit price bid for "Temporary Sediment Control Fence (Remove)". This price shall be full compensation for removing the fence from the

existing location, for stockpiling for future use, for proper disposal of damaged material, and for all manipulations, labor, tools, equipment and incidentals necessary to complete the work.

Stabilization (as described under "Maintenance") will be measured and paid for under the various pertinent bid items.

# GOVERNING SPECIFICATIONS AND SPECIAL PROVISIONS

All specifications and special provisions applicable to this project are identified as follows:

**STANDARD SPECIFICATIONS:** Adopted by the Texas Department of Transportation, June 1, 2004. Standard Specifications are incorporated into the contract by reference.

*Example:*

ITEM 247	FLEXIBLE BASE (204)
ITEM 502	BARRICADES, SIGNS AND TRAFFIC HANDLING
ITEM 530	DRIVEWAYS AND TURNOUTS
ITEM 5010	CONSTRUCTION EXITS

**SPECIAL PROVISIONS:** Special Provisions will govern and take precedence over the Specifications enumerated hereon wherever in conflict therewith. (Enclosed herewith)

**General:** The above listed specifications items are those under which payment is to be made. These, together with such other pertinent items, if any, as may be referred to in the above-listed specification items, and including the special provisions listed above, constitute the complete specifications for this project.

All item numbers noted in these plans are the same as those referenced in the Texas Department of Transportation 2004 Standard Specifications for Construction and Maintenance of Highways, Streets, and Bridges book (June 1, 2004)

**Certification  
Regarding Debarment, Suspension and Ineligibility**

As is required by the Federal Regulations Implementing Executive Order 12549, Debarment and Suspension, 45 CFR Part 76, Government-wide Debarment and Suspension, the applicant certifies, to the best of his or her knowledge and belief, that both it and its principals:

- a. Are not presently debarred, suspended, proposed for debarment, declared ineligible, or voluntarily excluded from participation in this transaction by any federal department or agency;
- b. Have not within a three-year period preceding this bid proposal and/or application been convicted of or had a civil judgment rendered against them for commission of fraud or a criminal offense in connection with obtaining, attempting to obtain, or performing a public (federal, state, or local) transaction or contract under a public transaction, violation of federal or state antitrust statutes or commission of embezzlement, theft, forgery, bribery, falsification or destruction of records, making false statements, or receiving stolen property;
- c. Are not presently indicted for or otherwise criminally or civilly charged by a government entity with commission of any of the offenses enumerated herein; and
- d. Have not within a three-year period preceding this bid proposal and/or application had one or more public transactions terminated for cause or default.

Signature: \_\_\_\_\_  
Print Name: \_\_\_\_\_  
Title: \_\_\_\_\_  
Telephone Number: \_\_\_\_\_  
Date: \_\_\_\_\_

If the bidder is unable to certify to all of the statements in this Certification, such bidder should attach an explanation to this proposal.

## Request for Taxpayer Identification Number and Certification

**Give form to the  
 requester. Do not  
 send to the IRS.**

Print or type  
 See Specific Instructions on page 2.

Name (as shown on your income tax return)	
Business name, if different from above	
Check appropriate box: <input type="checkbox"/> Individual/ Sole proprietor <input type="checkbox"/> Corporation <input type="checkbox"/> Partnership <input type="checkbox"/> Other ▶ .....	
<input type="checkbox"/> Exempt from backup withholding	
Address (number, street, and apt. or suite no.)	Requester's name and address (optional)
City, state, and ZIP code	
List account number(s) here (optional)	

### Part I Taxpayer Identification Number (TIN)

Enter your TIN in the appropriate box. The TIN provided must match the name given on Line 1 to avoid backup withholding. For individuals, this is your social security number (SSN). However, for a resident alien, sole proprietor, or disregarded entity, see the Part I instructions on page 3. For other entities, it is your employer identification number (EIN). If you do not have a number, see *How to get a TIN* on page 3.

Social security number

or

Employer identification number

**Note.** If the account is in more than one name, see the chart on page 4 for guidelines on whose number to enter.

### Part II Certification

Under penalties of perjury, I certify that:

1. The number shown on this form is my correct taxpayer identification number (or I am waiting for a number to be issued to me), and
2. I am not subject to backup withholding because: (a) I am exempt from backup withholding, or (b) I have not been notified by the Internal Revenue Service (IRS) that I am subject to backup withholding as a result of a failure to report all interest or dividends, or (c) the IRS has notified me that I am no longer subject to backup withholding, and
3. I am a U.S. person (including a U.S. resident alien).

**Certification instructions.** You must cross out item 2 above if you have been notified by the IRS that you are currently subject to backup withholding because you have failed to report all interest and dividends on your tax return. For real estate transactions, item 2 does not apply. For mortgage interest paid, acquisition or abandonment of secured property, cancellation of debt, contributions to an individual retirement arrangement (IRA), and generally, payments other than interest and dividends, you are not required to sign the Certification, but you must provide your correct TIN. (See the instructions on page 4.)

**Sign Here**

Signature of  
 U.S. person ▶

Date ▶

### Purpose of Form

A person who is required to file an information return with the IRS, must obtain your correct taxpayer identification number (TIN) to report, for example, income paid to you, real estate transactions, mortgage interest you paid, acquisition or abandonment of secured property, cancellation of debt, or contributions you made to an IRA.

**U.S. person.** Use Form W-9 only if you are a U.S. person (including a resident alien), to provide your correct TIN to the person requesting it (the requester) and, when applicable, to:

1. Certify that the TIN you are giving is correct (or you are waiting for a number to be issued),
2. Certify that you are not subject to backup withholding, or
3. Claim exemption from backup withholding if you are a U.S. exempt payee.

In 3 above, if applicable, you are also certifying that as a U.S. person, your allocable share of any partnership income from a U.S. trade or business is not subject to the withholding tax on foreign partners' share of effectively connected income.

**Note.** If a requester gives you a form other than Form W-9 to request your TIN, you must use the requester's form if it is substantially similar to this Form W-9.

For federal tax purposes, you are considered a person if you are:

- An individual who is a citizen or resident of the United States,
- A partnership, corporation, company, or association created or organized in the United States or under the laws of the United States, or
- Any estate (other than a foreign estate) or trust. See Regulations sections 301.7701-6(a) and 7(a) for additional information.

**Special rules for partnerships.** Partnerships that conduct a trade or business in the United States are generally required to pay a withholding tax on any foreign partners' share of income from such business. Further, in certain cases where a Form W-9 has not been received, a partnership is required to presume that a partner is a foreign person, and pay the withholding tax. Therefore, if you are a U.S. person that is a partner in a partnership conducting a trade or business in the United States, provide Form W-9 to the partnership to establish your U.S. status and avoid withholding on your share of partnership income.

The person who gives Form W-9 to the partnership for purposes of establishing its U.S. status and avoiding withholding on its allocable share of net income from the partnership conducting a trade or business in the United States is in the following cases:

- The U.S. owner of a disregarded entity and not the entity,

- The U.S. grantor or other owner of a grantor trust and not the trust, and
- The U.S. trust (other than a grantor trust) and not the beneficiaries of the trust.

**Foreign person.** If you are a foreign person, do not use Form W-9. Instead, use the appropriate Form W-8 (see Publication 515, Withholding of Tax on Nonresident Aliens and Foreign Entities).

**Nonresident alien who becomes a resident alien.**

Generally, only a nonresident alien individual may use the terms of a tax treaty to reduce or eliminate U.S. tax on certain types of income. However, most tax treaties contain a provision known as a "saving clause." Exceptions specified in the saving clause may permit an exemption from tax to continue for certain types of income even after the recipient has otherwise become a U.S. resident alien for tax purposes.

If you are a U.S. resident alien who is relying on an exception contained in the saving clause of a tax treaty to claim an exemption from U.S. tax on certain types of income, you must attach a statement to Form W-9 that specifies the following five items:

1. The treaty country. Generally, this must be the same treaty under which you claimed exemption from tax as a nonresident alien.
2. The treaty article addressing the income.
3. The article number (or location) in the tax treaty that contains the saving clause and its exceptions.
4. The type and amount of income that qualifies for the exemption from tax.
5. Sufficient facts to justify the exemption from tax under the terms of the treaty article.

**Example.** Article 20 of the U.S.-China income tax treaty allows an exemption from tax for scholarship income received by a Chinese student temporarily present in the United States. Under U.S. law, this student will become a resident alien for tax purposes if his or her stay in the United States exceeds 5 calendar years. However, paragraph 2 of the first Protocol to the U.S.-China treaty (dated April 30, 1984) allows the provisions of Article 20 to continue to apply even after the Chinese student becomes a resident alien of the United States. A Chinese student who qualifies for this exception (under paragraph 2 of the first protocol) and is relying on this exception to claim an exemption from tax on his or her scholarship or fellowship income would attach to Form W-9 a statement that includes the information described above to support that exemption.

If you are a nonresident alien or a foreign entity not subject to backup withholding, give the requester the appropriate completed Form W-8.

**What is backup withholding?** Persons making certain payments to you must under certain conditions withhold and pay to the IRS 28% of such payments (after December 31, 2002). This is called "backup withholding." Payments that may be subject to backup withholding include interest, dividends, broker and barter exchange transactions, rents, royalties, nonemployee pay, and certain payments from fishing boat operators. Real estate transactions are not subject to backup withholding.

You will not be subject to backup withholding on payments you receive if you give the requester your correct TIN, make the proper certifications, and report all your taxable interest and dividends on your tax return.

**Payments you receive will be subject to backup withholding if:**

1. You do not furnish your TIN to the requester,
2. You do not certify your TIN when required (see the Part II instructions on page 4 for details),

3. The IRS tells the requester that you furnished an incorrect TIN,

4. The IRS tells you that you are subject to backup withholding because you did not report all your interest and dividends on your tax return (for reportable interest and dividends only), or

5. You do not certify to the requester that you are not subject to backup withholding under 4 above (for reportable interest and dividend accounts opened after 1983 only).

Certain payees and payments are exempt from backup withholding. See the instructions below and the separate Instructions for the Requester of Form W-9.

Also see *Special rules regarding partnerships* on page 1.

## Penalties

**Failure to furnish TIN.** If you fail to furnish your correct TIN to a requester, you are subject to a penalty of \$50 for each such failure unless your failure is due to reasonable cause and not to willful neglect.

**Civil penalty for false information with respect to withholding.** If you make a false statement with no reasonable basis that results in no backup withholding, you are subject to a \$500 penalty.

**Criminal penalty for falsifying information.** Willfully falsifying certifications or affirmations may subject you to criminal penalties including fines and/or imprisonment.

**Misuse of TINs.** If the requester discloses or uses TINs in violation of federal law, the requester may be subject to civil and criminal penalties.

## Specific Instructions

### Name

If you are an individual, you must generally enter the name shown on your income tax return. However, if you have changed your last name, for instance, due to marriage without informing the Social Security Administration of the name change, enter your first name, the last name shown on your social security card, and your new last name.

If the account is in joint names, list first, and then circle, the name of the person or entity whose number you entered in Part I of the form.

**Sole proprietor.** Enter your individual name as shown on your income tax return on the "Name" line. You may enter your business, trade, or "doing business as (DBA)" name on the "Business name" line.

**Limited liability company (LLC).** If you are a single-member LLC (including a foreign LLC with a domestic owner) that is disregarded as an entity separate from its owner under Treasury regulations section 301.7701-3, enter the owner's name on the "Name" line. Enter the LLC's name on the "Business name" line. Check the appropriate box for your filing status (sole proprietor, corporation, etc.), then check the box for "Other" and enter "LLC" in the space provided.

**Other entities.** Enter your business name as shown on required federal tax documents on the "Name" line. This name should match the name shown on the charter or other legal document creating the entity. You may enter any business, trade, or DBA name on the "Business name" line.

**Note.** You are requested to check the appropriate box for your status (individual/sole proprietor, corporation, etc.).

### Exempt From Backup Withholding

If you are exempt, enter your name as described above and check the appropriate box for your status, then check the "Exempt from backup withholding" box in the line following the business name, sign and date the form.

Generally, individuals (including sole proprietors) are not exempt from backup withholding. Corporations are exempt from backup withholding for certain payments, such as interest and dividends.

**Note.** If you are exempt from backup withholding, you should still complete this form to avoid possible erroneous backup withholding.

**Exempt payees.** Backup withholding is not required on any payments made to the following payees:

1. An organization exempt from tax under section 501(a), any IRA, or a custodial account under section 403(b)(7) if the account satisfies the requirements of section 401(f)(2),
  2. The United States or any of its agencies or instrumentalities,
  3. A state, the District of Columbia, a possession of the United States, or any of their political subdivisions or instrumentalities,
  4. A foreign government or any of its political subdivisions, agencies, or instrumentalities, or
  5. An international organization or any of its agencies or instrumentalities.
- Other payees that may be exempt from backup withholding include:
6. A corporation,
  7. A foreign central bank of issue,
  8. A dealer in securities or commodities required to register in the United States, the District of Columbia, or a possession of the United States,
  9. A futures commission merchant registered with the Commodity Futures Trading Commission,
  10. A real estate investment trust,
  11. An entity registered at all times during the tax year under the Investment Company Act of 1940,
  12. A common trust fund operated by a bank under section 584(a),
  13. A financial institution,
  14. A middleman known in the investment community as a nominee or custodian, or
  15. A trust exempt from tax under section 664 or described in section 4947.

The chart below shows types of payments that may be exempt from backup withholding. The chart applies to the exempt recipients listed above, 1 through 15.

IF the payment is for . . .	THEN the payment is exempt for . . .
Interest and dividend payments	All exempt recipients except for 9
Broker transactions	Exempt recipients 1 through 13. Also, a person registered under the Investment Advisers Act of 1940 who regularly acts as a broker
Barter exchange transactions and patronage dividends	Exempt recipients 1 through 5
Payments over \$600 required to be reported and direct sales over \$5,000 <sup>1</sup>	Generally, exempt recipients 1 through 7 <sup>2</sup>

<sup>1</sup> See Form 1099-MISC, Miscellaneous Income, and its instructions.

<sup>2</sup> However, the following payments made to a corporation (including gross proceeds paid to an attorney under section 6045(f), even if the attorney is a corporation) and reportable on Form 1099-MISC are not exempt from backup withholding: medical and health care payments, attorneys' fees; and payments for services paid by a federal executive agency.

## Part I. Taxpayer Identification Number (TIN)

**Enter your TIN in the appropriate box.** If you are a resident alien and you do not have and are not eligible to get an SSN, your TIN is your IRS individual taxpayer identification number (ITIN). Enter it in the social security number box. If you do not have an ITIN, see *How to get a TIN* below.

If you are a sole proprietor and you have an EIN, you may enter either your SSN or EIN. However, the IRS prefers that you use your SSN.

If you are a single-owner LLC that is disregarded as an entity separate from its owner (see *Limited liability company (LLC)* on page 2), enter your SSN (or EIN, if you have one). If the LLC is a corporation, partnership, etc., enter the entity's EIN.

**Note.** See the chart on page 4 for further clarification of name and TIN combinations.

**How to get a TIN.** If you do not have a TIN, apply for one immediately. To apply for an SSN, get Form SS-5, Application for a Social Security Card, from your local Social Security Administration office or get this form online at [www.socialsecurity.gov](http://www.socialsecurity.gov). You may also get this form by calling 1-800-772-1213. Use Form W-7, Application for IRS Individual Taxpayer Identification Number, to apply for an ITIN, or Form SS-4, Application for Employer Identification Number, to apply for an EIN. You can apply for an EIN online by accessing the IRS website at [www.irs.gov/businesses](http://www.irs.gov/businesses) and clicking on Employer ID Numbers under Related Topics. You can get Forms W-7 and SS-4 from the IRS by visiting [www.irs.gov](http://www.irs.gov) or by calling 1-800-TAX-FORM (1-800-829-3676).

If you are asked to complete Form W-9 but do not have a TIN, write "Applied For" in the space for the TIN, sign and date the form, and give it to the requester. For interest and dividend payments, and certain payments made with respect to readily tradable instruments, generally you will have 60 days to get a TIN and give it to the requester before you are subject to backup withholding on payments. The 60-day rule does not apply to other types of payments. You will be subject to backup withholding on all such payments until you provide your TIN to the requester.

**Note.** Writing "Applied For" means that you have already applied for a TIN or that you intend to apply for one soon.

**Caution:** A disregarded domestic entity that has a foreign owner must use the appropriate Form W-8.

## Part II. Certification

To establish to the withholding agent that you are a U.S. person, or resident alien, sign Form W-9. You may be requested to sign by the withholding agent even if items 1, 4, and 5 below indicate otherwise.

For a joint account, only the person whose TIN is shown in Part I should sign (when required). Exempt recipients, see *Exempt From Backup Withholding* on page 2.

**Signature requirements.** Complete the certification as indicated in 1 through 5 below.

**1. Interest, dividend, and barter exchange accounts opened before 1984 and broker accounts considered active during 1983.** You must give your correct TIN, but you do not have to sign the certification.

**2. Interest, dividend, broker, and barter exchange accounts opened after 1983 and broker accounts considered inactive during 1983.** You must sign the certification or backup withholding will apply. If you are subject to backup withholding and you are merely providing your correct TIN to the requester, you must cross out item 2 in the certification before signing the form.

**3. Real estate transactions.** You must sign the certification. You may cross out item 2 of the certification.

**4. Other payments.** You must give your correct TIN, but you do not have to sign the certification unless you have been notified that you have previously given an incorrect TIN. "Other payments" include payments made in the course of the requester's trade or business for rents, royalties, goods (other than bills for merchandise), medical and health care services (including payments to corporations), payments to a nonemployee for services, payments to certain fishing boat crew members and fishermen, and gross proceeds paid to attorneys (including payments to corporations).

**5. Mortgage interest paid by you, acquisition or abandonment of secured property, cancellation of debt, qualified tuition program payments (under section 529), IRA, Coverdell ESA, Archer MSA or HSA contributions or distributions, and pension distributions.** You must give your correct TIN, but you do not have to sign the certification.

## What Name and Number To Give the Requester

For this type of account:	Give name and SSN of:
1. Individual	The individual
2. Two or more individuals (joint account)	The actual owner of the account or, if combined funds, the first individual on the account <sup>1</sup>
3. Custodian account of a minor (Uniform Gift to Minors Act)	The minor <sup>2</sup>
4. a. The usual revocable savings trust (grantor is also trustee)	The grantor-trustee <sup>1</sup>
b. So-called trust account that is not a legal or valid trust under state law	The actual owner <sup>1</sup>
5. Sole proprietorship or single-owner LLC	The owner <sup>3</sup>
For this type of account:	Give name and EIN of:
6. Sole proprietorship or single-owner LLC	The owner <sup>3</sup>
7. A valid trust, estate, or pension trust	Legal entity <sup>4</sup>
8. Corporate or LLC electing corporate status on Form 8832	The corporation
9. Association, club, religious, charitable, educational, or other tax-exempt organization	The organization
10. Partnership or multi-member LLC	The partnership
11. A broker or registered nominee	The broker or nominee
12. Account with the Department of Agriculture in the name of a public entity (such as a state or local government, school district, or prison) that receives agricultural program payments	The public entity

<sup>1</sup> List first and circle the name of the person whose number you furnish. If only one person on a joint account has an SSN, that person's number must be furnished.

<sup>2</sup> Circle the minor's name and furnish the minor's SSN.

<sup>3</sup> You must show your individual name and you may also enter your business or "DBA" name on the second name line. You may use either your SSN or EIN (if you have one). If you are a sole proprietor, IRS encourages you to use your SSN.

<sup>4</sup> List first and circle the name of the legal trust, estate, or pension trust. (Do not furnish the TIN of the personal representative or trustee unless the legal entity itself is not designated in the account title.) Also see *Special rules regarding partnerships* on page 1.

**Note.** If no name is circled when more than one name is listed, the number will be considered to be that of the first name listed.

## Privacy Act Notice

Section 6109 of the Internal Revenue Code requires you to provide your correct TIN to persons who must file information returns with the IRS to report interest, dividends, and certain other income paid to you, mortgage interest you paid, the acquisition or abandonment of secured property, cancellation of debt, or contributions you made to an IRA, or Archer MSA or HSA. The IRS uses the numbers for identification purposes and to help verify the accuracy of your tax return. The IRS may also provide this information to the Department of Justice for civil and criminal litigation, and to cities, states, the District of Columbia, and U.S. possessions to carry out their tax laws. We may also disclose this information to other countries under a tax treaty, to federal and state agencies to enforce federal nontax criminal laws, or to federal law enforcement and intelligence agencies to combat terrorism.

You must provide your TIN whether or not you are required to file a tax return. Payers must generally withhold 28% of taxable interest, dividend, and certain other payments to a payee who does not give a TIN to a payer. Certain penalties may also apply.



**HISTORICALLY UNDERUTILIZED BUSINESS (HUB) DECLARATION**

The primary objective of the Hidalgo County HUB Program is to ensure Historically Underutilized Businesses receive a fair and equal opportunity for participation in the County's procurement process. This fact holds true for Services (Professional & Non-Professional), Commodities, and Construction contracts and any subcontracts thereto. The program strongly encourages Prime Contractors to provide subcontracting opportunities to Certified Hub Contractors/Vendors. Our goal for HUB contractor/vendor participation, as well as HUB subcontractor participation is 30%. To be considered as a "Certified HUB Contractor/Vendor" the contractor/vendor must have been certified by, and hold a current and valid certification with any of the three agencies listed below.

Have you been Certified as a HUB or an MBE/WBE source?:  Yes  No  
If yes, by whom?:  Texas Building & Procurement Commission  Other \_\_\_\_\_  
Indicate Certification No(s): \_\_\_\_\_ or Are Certificate(s) Attached?:  Yes  No

---

**LIST OF CERTIFIED HUB SUBCONTRACTORS**  
(Attach additional pages if necessary)

What percentage of the Bid, RFP, or RFQ is to be subcontracted with Certified HUB sources?: \_\_\_\_\_%  
(List HUB Subcontractor information below).

HUB Subcontractor Name: \_\_\_\_\_ HUB Status: \_\_\_\_\_  
Certifying Agency (Check all applicable):  Texas Building & Procurement Commission  Other  
Address: \_\_\_\_\_ City: \_\_\_\_\_ State: \_\_\_\_\_ Zip: \_\_\_\_\_  
Contact Person: \_\_\_\_\_ Title: \_\_\_\_\_ Phone No.: ( ) \_\_\_\_\_  
Subcontract Amount: \$ \_\_\_\_\_ Description of Work to be Performed: \_\_\_\_\_

---

HUB Subcontractor Name: \_\_\_\_\_ HUB Status: \_\_\_\_\_  
Certifying Agency (Check all applicable):  Texas Building & Procurement Commission  Other  
Address: \_\_\_\_\_ City: \_\_\_\_\_ State: \_\_\_\_\_ Zip: \_\_\_\_\_  
Contact Person: \_\_\_\_\_ Title: \_\_\_\_\_ Phone No.: ( ) \_\_\_\_\_  
Subcontract Amount: \$ \_\_\_\_\_ Description of Work to be Performed: \_\_\_\_\_

---

HUB Subcontractor Name: \_\_\_\_\_ HUB Status: \_\_\_\_\_  
Certifying Agency (Check all applicable):  Texas Building & Procurement Commission  Other  
Address: \_\_\_\_\_ City: \_\_\_\_\_ State: \_\_\_\_\_ Zip: \_\_\_\_\_  
Contact Person: \_\_\_\_\_ Title: \_\_\_\_\_ Phone No.: ( ) \_\_\_\_\_  
Subcontract Amount: \$ \_\_\_\_\_ Description of Work to be Performed: \_\_\_\_\_

---

## **DISCLOSURE OF CONFLICT OF INTEREST**

Effective January 1, 2006, Chapter 176 of the Texas Local Government Code requires that any vendor, person, consultant or contractor considering doing business with Hidalgo County (“the County”) to disclose in the Conflict of Interest Questionnaire (the “CIQ”) attached as Exhibit D, the vendor, person, consultant or contractor’s affiliation or business relationship that might cause a conflict of interest with the County. By law, the CIQ must be filed with the Hidalgo County Clerk’s Office no later than the seventh business day after the date the person becomes aware of facts that require that statement to be filed. The disclosure requirement applies to a person or business who contracts or seeks to contract with Hidalgo County for the sale or purchase of property, goods or service. Any purchase order or contract resulting from this process shall be considered null and void if the successful bidder fails to comply with Texas Local Government Code Chapter 176. Vendors, consultants, contractors and others who desire to conduct business with Hidalgo County are encouraged to refer to Texas Local Government Code Chapter 176 for the details of this law. An offense under Texas Local Government Code Chapter 176 is a Class C Misdemeanor.

**Please Submit completed forms to the Hidalgo County Clerk’s Office located at 100 N. Closner, Edinburg, Texas 78539-Hidalgo County Courthouse**

**COMPLETION AND SUBMISSION OF FORM CIQ IS THE SOLE RESPONSIBILITY OF THE PROSPECTIVE BIDDER.**

# CONFLICT OF INTEREST QUESTIONNAIRE

## FORM CIQ

For vendor or other person doing business with local governmental entity

This questionnaire reflects changes made to the law by H.B. 1491, 80th Leg., Regular Session.

This questionnaire is being filed in accordance with Chapter 176, Local Government Code by a person who has a business relationship as defined by Section 176.001(1-a) with a local governmental entity and the person meets requirements under Section 176.006(a).

By law this questionnaire must be filed with the records administrator of the local governmental entity not later than the 7th business day after the date the person becomes aware of facts that require the statement to be filed. See Section 176.006, Local Government Code.

A person commits an offense if the person knowingly violates Section 176.006, Local Government Code. An offense under this section is a Class C misdemeanor.

### OFFICE USE ONLY

Date Received

**1** Name of person who has a business relationship with local governmental entity.

**2**  Check this box if you are filing an update to a previously filed questionnaire.

(The law requires that you file an updated completed questionnaire with the appropriate filing authority not later than the 7th business day after the date the originally filed questionnaire becomes incomplete or inaccurate.)

**3** Name of local government officer with whom filer has employment or business relationship.

\_\_\_\_\_  
Name of Officer

This section (item 3 including subparts A, B, C & D) must be completed for each officer with whom the filer has an employment or other business relationship as defined by Section 176.001(1-a), Local Government Code. Attach additional pages to this Form CIQ as necessary.

A. Is the local government officer named in this section receiving or likely to receive taxable income, other than investment income, from the filer of the questionnaire?

Yes       No

B. Is the filer of the questionnaire receiving or likely to receive taxable income, other than investment income, from or at the direction of the local government officer named in this section AND the taxable income is not received from the local governmental entity?

Yes       No

C. Is the filer of this questionnaire employed by a corporation or other business entity with respect to which the local government officer serves as an officer or director, or holds an ownership of 10 percent or more?

Yes       No

D. Describe each employment or business relationship with the local government officer named in this section.

**4**

\_\_\_\_\_  
Signature of person doing business with the governmental entity

\_\_\_\_\_  
Date

**SALES TAX AND LOCAL SALES TAX  
EXEMPTION CERTIFICATE FOR CONTRACTORS**

This Contract is to be performed for an exempt organization as defined by Article 20.04 (H) (4) of the Texas Limited Sales, Excise, and Use Tax Act and the undersigned hereby claims an exemption from payment of taxes under Chapter 20, title 122A, revised hereby claims an exemption from payment of taxes under Chapter 20, title 122A, revised civil statutes of Texas, and Article 1066 ©, entitle Local Sales and Use Tax, revised civil statutes of Texas.

The Contractor performing this Contract may purchase, rent, or lease all materials, supplies, equipment used for consumed in the performance of this Contract by issuing to his retailer an exemption certificate in lieu of the tax, said exemption certificate complying with State Comptroller's Ruling No 95-9.07. Any such exemption certificate issue by the Contractor in lieu of the tax shall be subject to the provisions of the State Comptroller's Ruling No. 95.0.09 as amended to be effective October 2, 1968.

EXECUTED this the \_\_\_\_\_ day of \_\_\_\_\_, 20\_\_\_\_\_.

\_\_\_\_\_  
Contractor

GOVERNMENT CODE

CHAPTER 2258. PREVAILING WAGE RATES

SUBCHAPTER A. GENERAL PROVISIONS

§Sec. 2258.001. DEFINITIONS. In this chapter:

(1) "Locality in which the work is performed" means:

(A) for a contract for a public work awarded by the state, the political subdivision of the state in which the public work is located:

(i) which may include a county, municipality, county and municipality, or district, except as provided by Subparagraph (ii); and

(ii) which, in a municipality with a population of 500,000 or more, may only include the geographic limits of the municipality; or

(B) for a contract for a public work awarded by a political subdivision of the state, the geographical limits of the political subdivision.

(2) "Public body" means a public body awarding a contract for a public work on behalf of the state or a political subdivision of the state.

(3) "Worker" includes a laborer or mechanic.

Added by Acts 1995, 74th Leg., ch. 76, Sec. 5.49(a), eff. Sept. 1, 1995. Amended by Acts 2001, 77th Leg., ch. 1422, Sec. 14.04, eff. Sept. 1, 2001.

§Sec. 2258.002. APPLICABILITY OF CHAPTER TO PUBLIC WORKS. (a) This chapter applies only to the construction of a public work, including a building, highway, road, excavation, and repair work or other project development or improvement, paid for in whole or in part from public funds, without regard to whether the work is done under public supervision or direction.

(b) This chapter does not apply to work done directly by a public utility company under an order of a public authority.

Added by Acts 1995, 74th Leg., ch. 76, Sec. 5.49(a), eff. Sept. 1, 1995.

§Sec. 2258.003. LIABILITY. An officer, agent, or employee of a public body is not liable in a civil action for any act or omission implementing or enforcing this chapter unless the action was made in bad faith.

Added by Acts 1995, 74th Leg., ch. 76, Sec. 5.49(a), eff. Sept. 1, 1995.

SUBCHAPTER B. PAYMENT OF PREVAILING WAGE RATES

§Sec. 2258.021. RIGHT TO BE PAID PREVAILING WAGE RATES. (a) A worker employed on a public work by or on behalf of the state or a political subdivision of the state shall be paid:

(1) not less than the general prevailing rate of per diem wages for work of a similar

character in the locality in which the work is performed; and

(2) not less than the general prevailing rate of per diem wages for legal holiday and overtime work.

(b) Subsection (a) does not apply to maintenance work.

(c) A worker is employed on a public work for the purposes of this section if the worker is employed by a contractor or subcontractor in the execution of a contract for the public work with the state, a political subdivision of the state, or any officer or public body of the state or a political subdivision of the state.

Added by Acts 1995, 74th Leg., ch. 76, Sec. 5.49(a), eff. Sept. 1, 1995. Amended by Acts 1997, 75th Leg., ch. 165, Sec. 18.01, eff. Sept. 1, 1997.

#### §Sec. 2258.022. DETERMINATION OF PREVAILING WAGE RATES.

(a) For a contract for a public work awarded by a political subdivision of the state, the public body shall determine the general prevailing rate of per diem wages in the locality in which the public work is to be performed for each craft or type of worker needed to execute the contract and the prevailing rate for legal holiday and overtime work by:

(1) conducting a survey of the wages received by classes of workers employed on projects of a character similar to the contract work in the political subdivision of the state in which the public work is to be performed; or

(2) using the prevailing wage rate as determined by the United States Department of Labor in accordance with the Davis-Bacon Act (40 U.S.C. Section 276a et seq.), and its subsequent amendments.

(b) This subsection applies only to a public work located in a county bordering the United Mexican States or in a county adjacent to a county bordering the United Mexican States. For a contract for a public work awarded by the state, the public body shall determine the general prevailing rate of per diem wages in the locality in which the public work is to be performed for each craft or type of worker needed to execute the contract and the prevailing rate for legal holiday and overtime work as follows. The public body shall conduct a survey of the wages received by classes of workers employed on projects of a character similar to the contract work both statewide and in the political subdivision of the state in which the public work is to be performed. The public body shall also consider the prevailing wage rate as determined by the United States Department of Labor in accordance with the Davis-Bacon Act (40 U.S.C. Section 276a et seq.), and its subsequent amendments, but only if the survey used to determine that rate was conducted within a three-year period preceding the date the public body calls for bids for the public work. The public body shall determine the general prevailing rate of per diem wages in the locality based on the higher of:

(1) the rate determined from the survey conducted in the political subdivision;

(2) the arithmetic mean between the rate determined from the survey conducted in the political subdivision and the rate determined from the statewide survey; and

(3) if applicable, the arithmetic mean between the rate determined from the survey conducted in the political subdivision and the rate determined by the United States Department of Labor.

(c) The public body shall determine the general prevailing rate of per diem wages as a sum certain, expressed in dollars and cents.

(d) A public body shall specify in the call for bids for the contract and in the contract itself the wage rates determined under this section.

(e) The public body's determination of the general prevailing rate of per diem wages is final.

Added by Acts 1995, 74th Leg., ch. 76, Sec. 5.49(a), eff. Sept. 1, 1995. Amended by Acts 1997, 75th Leg., ch. 165, Sec. 18.02, eff. Sept. 1, 1997; Acts 2001, 77th Leg., ch. 1422, Sec. 14.05, eff. Sept. 1, 2001.

Amended by: Acts 2007, 80th Leg., R.S., Ch. 728, Sec. 1, eff. September 1, 2007.

**§Sec. 2258.023. PREVAILING WAGE RATES TO BE PAID BY CONTRACTOR AND SUBCONTRACTOR; PENALTY.**

(a) The contractor who is awarded a contract by a public body or a subcontractor of the contractor shall pay not less than the rates determined under Section 2258.022 to a worker employed by it in the execution of the contract.

(b) A contractor or subcontractor who violates this section shall pay to the state or a political subdivision of the state on whose behalf the contract is made, \$60 for each worker employed for each calendar day or part of the day that the worker is paid less than the wage rates stipulated in the contract. A public body awarding a contract shall specify this penalty in the contract.

(c) A contractor or subcontractor does not violate this section if a public body awarding a contract does not determine the prevailing wage rates and specify the rates in the contract as provided by Section 2258.022.

(d) The public body shall use any money collected under this section to offset the costs incurred in the administration of this chapter.

(e) A municipality is entitled to collect a penalty under this section only if the municipality has a population of more than 10,000.

Added by Acts 1995, 74th Leg., ch. 76, Sec. 5.49(a), eff. Sept. 1, 1995.

**§Sec. 2258.024. RECORDS.**

(a) A contractor and subcontractor shall keep a record showing:

(1) the name and occupation of each worker employed by the contractor or subcontractor in the construction of the public work; and

(2) the actual per diem wages paid to each worker.

(b) The record shall be open at all reasonable hours to inspection by the officers and agents of the public body.

Added by Acts 1995, 74th Leg., ch. 76, Sec. 5.49(a), eff. Sept. 1, 1995.

**§Sec. 2258.025. PAYMENT GREATER THAN PREVAILING RATE NOT PROHIBITED.** This chapter does not prohibit the payment to a worker employed on a public work an amount greater than the general prevailing rate of per diem wages.

Added by Acts 1995, 74th Leg., ch. 76, Sec. 5.49(a), eff. Sept. 1, 1995.

§Sec. 2258.026. RELIANCE ON CERTIFICATE OF SUBCONTRACTOR. A contractor is entitled to rely on a certificate by a subcontractor regarding the payment of all sums due those working for the subcontractor until the contrary has been determined.

Added by Acts 1995, 74th Leg., ch. 76, Sec. 5.49(a), eff. Sept. 1, 1995.

#### SUBCHAPTER C. ENFORCEMENT; CIVIL AND CRIMINAL PENALTIES

§Sec. 2258.051. DUTY OF PUBLIC BODY TO HEAR COMPLAINTS AND WITHHOLD PAYMENT. A public body awarding a contract, and an agent or officer of the public body, shall:

(1) take cognizance of complaints of all violations of this chapter committed in the execution of the contract; and

(2) withhold money forfeited or required to be withheld under this chapter from the payments to the contractor under the contract, except that the public body may not withhold money from other than the final payment without a determination by the public body that there is good cause to believe that the contractor has violated this chapter.

Added by Acts 1995, 74th Leg., ch. 76, Sec. 5.49(a), eff. Sept. 1, 1995.

§Sec. 2258.052. COMPLAINT; INITIAL DETERMINATION.

(a) On receipt of information, including a complaint by a worker, concerning an alleged violation of Section 2258.023 by a contractor or subcontractor, a public body shall make an initial determination as to whether good cause exists to believe that the violation occurred.

(b) A public body must make its determination under Subsection (a) before the 31st day after the date the public body receives the information.

(c) A public body shall notify in writing the contractor or subcontractor and any affected worker of its initial determination.

(d) A public body shall retain any amount due under the contract pending a final determination of the violation.

Added by Acts 1995, 74th Leg., ch. 76, Sec. 5.49(a), eff. Sept. 1, 1995.

§Sec. 2258.053. ARBITRATION REQUIRED FOR UNRESOLVED ISSUE.

(a) An issue relating to an alleged violation of Section 2258.023, including a penalty owed to a public body or an affected worker, shall be submitted to binding arbitration in accordance with the Texas General Arbitration Act (Article 224 et seq., Revised Statutes) if the contractor or subcontractor and any affected worker do not resolve the issue by agreement before the 15th day after the date the public body makes its initial determination under Section 2258.052.

(b) If the persons required to arbitrate under this section do not agree on an arbitrator before the 11th day after the date that arbitration is required under Subsection (a), a district court shall appoint an arbitrator on the petition of any of the persons.

(c) A public body is not a party in the arbitration.

Added by Acts 1995, 74th Leg., ch. 76, Sec. 5.49(a), eff. Sept. 1, 1995.

§Sec. 2258.054. ARBITRATION AWARD; COSTS. (a) If an arbitrator determines that Section 2258.023 has been violated, the arbitrator shall assess and award against the contractor or subcontractor:

- (1) penalties as provided by Section 2258.023 and this section; and
- (2) all amounts owed to the affected worker.

(b) An arbitrator shall assess and award all reasonable costs, including the arbitrator's fee, against the party who does not prevail. Costs may be assessed against the worker only if the arbitrator finds that the claim is frivolous. If the arbitrator does not find that the claim is frivolous and does not make an award to the worker, costs are shared equally by the parties.

Added by Acts 1995, 74th Leg., ch. 76, Sec. 5.49(a), eff. Sept. 1, 1995.

§Sec. 2258.055. ARBITRATION DECISION AND AWARD FINAL. The decision and award of the arbitrator is final and binding on all parties and may be enforced in any court of competent jurisdiction.

Added by Acts 1995, 74th Leg., ch. 76, Sec. 5.49(a), eff. Sept. 1, 1995.

§Sec. 2258.056. PAYMENT BY PUBLIC BODY TO WORKER; ACTION TO RECOVER PAYMENT.

(a) A public body shall use any amounts retained under this chapter to pay the worker the difference between the amount the worker received in wages for labor on the public work at the rate paid by the contractor or subcontractor and the amount the worker would have received at the general prevailing wage rate as provided in the arbitrator's award.

(b) The public body may adopt rules, orders, or ordinances relating to the manner in which a reimbursement is made.

(c) If the amounts retained by a public body under this chapter are not sufficient for the public body to pay the worker the full amount owed, the worker has a right of action against the contractor or subcontractor and the surety of the contractor or subcontractor to recover the amount owed, reasonable attorney's fees, and court costs.

Added by Acts 1995, 74th Leg., ch. 76, Sec. 5.49(a), eff. Sept. 1, 1995.

§Sec. 2258.057. WITHHOLDING BY CONTRACTOR.

(a) A contractor may withhold from a subcontractor sufficient money to cover an amount withheld from the contractor by a public body because the subcontractor violated this chapter.

(b) If the contractor has made a payment to the subcontractor, the contractor may withhold money from any future payments owed to the subcontractor or sue the subcontractor or the subcontractor's surety for the amount withheld from the contractor by a public body because of the subcontractor's violation.

Added by Acts 1995, 74th Leg., ch. 76, Sec. 5.49(a), eff. Sept. 1, 1995.

§Sec. 2258.058. CRIMINAL OFFENSE.

(a) An officer, agent, or representative of the state or of a political subdivision of the state commits an offense if the person wilfully violates or does not comply with a provision of this chapter.

(b) A contractor or subcontractor of a public work under this chapter, or an agent or representative of the contractor or subcontractor, commits an offense if the person violates Section 2258.024.

(c) An offense under this section is punishable by:

- (1) a fine not to exceed \$500;
- (2) confinement in jail for a term not to exceed six months; or
- (3) both a fine and confinement.

Added by Acts 1995, 74th Leg., ch. 76, Sec. 5.49(a), eff. Sept. 1, 1995.



Steel Worker (Reinforcing).....\$ 14.07

TRUCK DRIVER

Lowboy-Float.....\$ 13.63
Single Axle.....\$ 10.82
Single or Tandem Axle Dump..\$ 14.53
Tandem Axle Tractor with
Semi Trailer.....\$ 12.12

WELDER.....\$ 14.02

WELDERS - Receive rate prescribed for craft performing
operation to which welding is incidental.

Unlisted classifications needed for work not included within
the scope of the classifications listed may be added after
award only as provided in the labor standards contract clauses
(29CFR 5.5 (a) (1) (ii)).

The body of each wage determination lists the classification
and wage rates that have been found to be prevailing for the
cited type(s) of construction in the area covered by the wage
determination. The classifications are listed in alphabetical
order of "identifiers" that indicate whether the particular
rate is union or non-union.

Union Identifiers

An identifier enclosed in dotted lines beginning with
characters other than "SU" denotes that the union
classification and rate have found to be prevailing for that
classification. Example: PLUM0198-005 07/01/2011. The
first four letters , PLUM, indicate the international union and
the four-digit number, 0198, that follows indicates the local
union number or district council number where applicable ,
i.e., Plumbers Local 0198. The next number, 005 in the
example, is an internal number used in processing the wage
determination. The date, 07/01/2011, following these
characters is the effective date of the most current
negotiated rate/collective bargaining agreement which would be
July 1, 2011 in the above example.

Union prevailing wage rates will be updated to reflect any
changes in the collective bargaining agreements governing the
rate.

Non-Union Identifiers

Classifications listed under an "SU" identifier were derived
from survey data by computing average rates and are not union
rates; however, the data used in computing these rates may
include both union and non-union data. Example: SULA2004-007
5/13/2010. SU indicates the rates are not union rates, LA
indicates the State of Louisiana; 2004 is the year of the
survey; and 007 is an internal number used in producing the

wage determination. A 1993 or later date, 5/13/2010, indicates the classifications and rates under that identifier were issued as a General Wage Determination on that date.

Survey wage rates will remain in effect and will not change until a new survey is conducted.

-----  
WAGE DETERMINATION APPEALS PROCESS

1.) Has there been an initial decision in the matter? This can be:

- \* an existing published wage determination
- \* a survey underlying a wage determination
- \* a Wage and Hour Division letter setting forth a position on a wage determination matter
- \* a conformance (additional classification and rate) ruling

On survey related matters, initial contact, including requests for summaries of surveys, should be with the Wage and Hour Regional Office for the area in which the survey was conducted because those Regional Offices have responsibility for the Davis-Bacon survey program. If the response from this initial contact is not satisfactory, then the process described in 2.) and 3.) should be followed.

With regard to any other matter not yet ripe for the formal process described here, initial contact should be with the Branch of Construction Wage Determinations. Write to:

Branch of Construction Wage Determinations  
Wage and Hour Division  
U.S. Department of Labor  
200 Constitution Avenue, N.W.  
Washington, DC 20210

2.) If the answer to the question in 1.) is yes, then an interested party (those affected by the action) can request review and reconsideration from the Wage and Hour Administrator (See 29 CFR Part 1.8 and 29 CFR Part 7). Write to:

Wage and Hour Administrator  
U.S. Department of Labor  
200 Constitution Avenue, N.W.  
Washington, DC 20210

The request should be accompanied by a full statement of the interested party's position and by any information (wage payment data, project description, area practice material, etc.) that the requestor considers relevant to the issue.

3.) If the decision of the Administrator is not favorable, an interested party may appeal directly to the Administrative Review Board (formerly the Wage Appeals Board). Write to:

Administrative Review Board  
U.S. Department of Labor  
200 Constitution Avenue, N.W.  
Washington, DC 20210

4.) All decisions by the Administrative Review Board are final.

=====

END OF GENERAL DECISION



*A Contractor's  
Guide to  
Prevailing  
Wage  
Requirements  
for  
Federally-Assisted  
Construction  
Projects*

**MAKING  
DAVIS-BACON  
WORK**

**June 2006**

**U.S. Department of Housing and Urban Development**



# Introduction

This Guide has been prepared for you as a contractor performing work on construction projects that are **assisted** by the Department of Housing and Urban Development and subject to Davis-Bacon prevailing wage requirements. This Guide **does not** address contractor requirements involved in **direct** Federal contracting where HUD or another Federal agency enters into a procurement contract. In this latter case, the Federal Acquisition Regulations (FAR) are applicable. While the guidance contained in this Guide is generally applicable to **any** Davis-Bacon covered project, specific questions pertaining to direct Federal contracts should be addressed to the Contracting Officer who signed the contract for the Federal agency.

Our objective here is to provide you with a guide which is simple and non-bureaucratic yet comprehensive and which will help you better understand and comply with Davis-Bacon labor standards. HUD's Office of Labor Relations worked closely with the Department of Labor's Wage and Hour Division to make sure that the labor standards provisions in your contract and the specifics of complying with them represent the latest information. It is the Department of Labor which has general administrative oversight of all Federal contracting agencies, such as HUD, which administer the day-to-day responsibilities of enforcing Davis-Bacon provisions in construction contracts they either fund or assist in funding.

There are three chapters in this Guide. The first chapter offers a brief description of the laws and regulations associated with Federal labor standards administration and enforcement and discusses both what's in your contract that requires Davis-Bacon compliance and your responsibilities. The second chapter deals with labor standards and payroll reporting requirements. The third chapter discusses what can happen in the event there is a dispute about the wage rates that should be (or have been) paid and any back wages that may be due.

Finally, not all HUD construction projects are covered by Davis-Bacon wage rates. For the purpose of this Guide, we are assuming that a determination has already been made that Davis-Bacon wage rates are applicable. Should you wish assistance in determining whether Davis-Bacon wage rates apply to a particular project or if you need other related technical assistance, please consult with the HUD Labor Relations Field staff for your area. If you don't know which staff to contact, a list of Labor Relations field offices and their geographic areas and telephone numbers can be found on HUD's Home Page at the address below.

Visit the Office of Labor Relations  
on the World Wide Web HUD Home Page at:  
***<http://www.hud.gov/offices/olr>***

Obtain additional copies of this Guide and other publications at our web site or by telephone from HUD's Customer Service Center at (800) 767-7468.

# MAKING DAVIS-BACON WORK

*A Contractor's Guide  
to Prevailing  
Wage Requirements  
for Federally-Assisted  
Construction Projects*



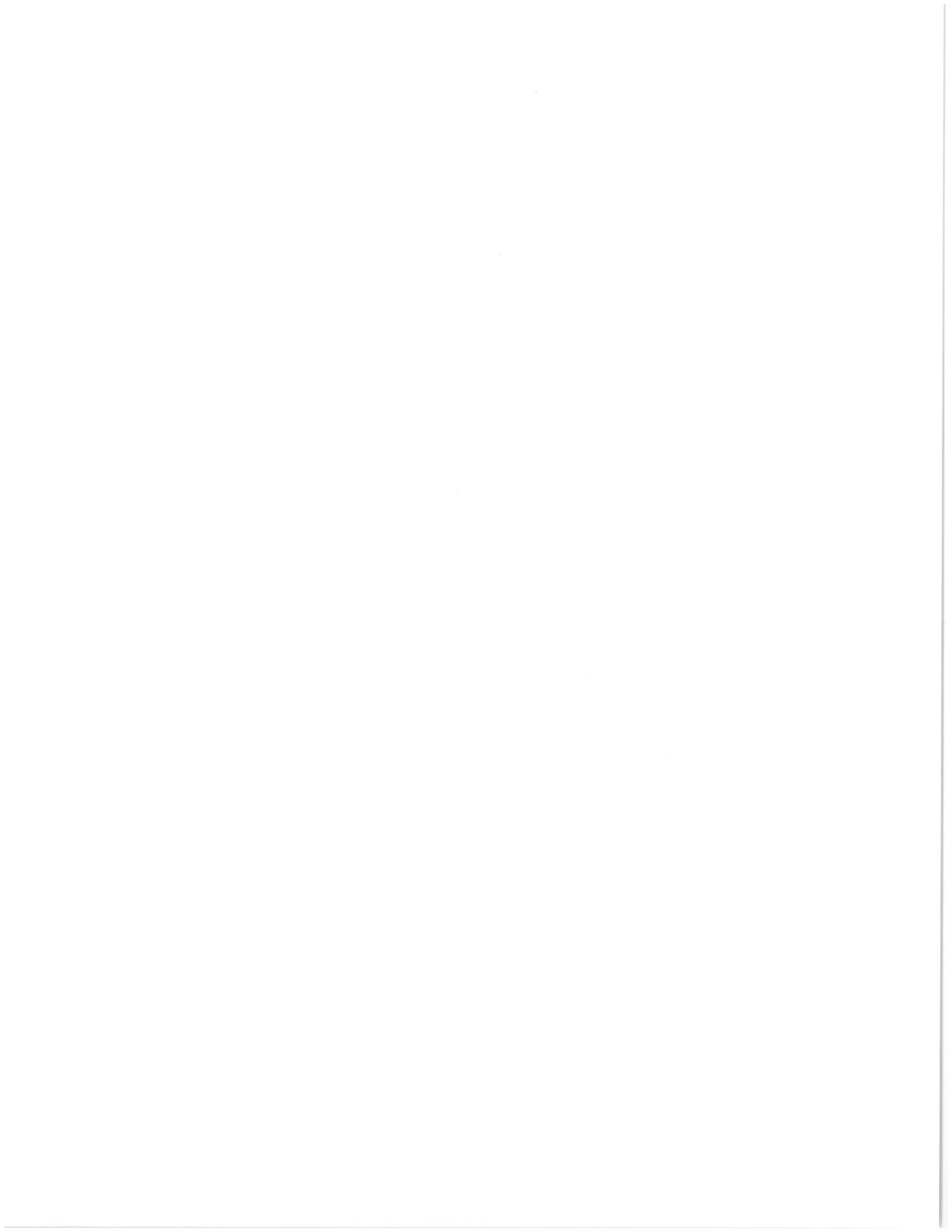

# Table of Contents

Introduction ..... i

## CHAPTER 1.

### Laws, Regulations, Contracts and Responsibilities

<b>1-1 Davis-Bacon and Other Labor Laws</b> .....	1-1
a. The Davis-Bacon Act (DBA) .....	1-1
b. The Contract Work Hours and Safety Standards Act (CWHSSA) .....	1-1
c. The Copeland Act (Anti-Kickback Act) .....	1-2
d. The Fair Labor Standards Act (FLSA) .....	1-2
<b>1-2 Davis-Bacon Regulations</b> .....	1-2
<b>1-3 Construction Contract Provisions</b> .....	1-2
<b>1-4 Responsibility of the Principal Contractor</b> .....	1-3
<b>1-5 Responsibility of the Contract Administrator</b> .....	1-3

## CHAPTER 2.

### How to Comply with Labor Standards and Payroll Reporting Requirements

#### SECTION I — THE BASICS

<b>2-1 The Wage Decision</b> .....	2-1
a. The work classifications and wage rates .....	2-1
b. Posting the wage decision .....	2-2
<b>2-2 Additional “Trade” Classifications and Wage Rates</b> .....	2-2
a. Additional classification rules .....	2-2
b. Making the request .....	2-2
c. HUD review .....	2-3
d. DOL decision .....	2-3
<b>2-3 Certified Payroll Reports</b> .....	2-3
a. Payroll formats .....	2-3
b. Payroll certifications .....	2-4
c. “No work” payrolls .....	2-4
d. Payroll review and submission .....	2-4
e. Payroll retention .....	2-4
f. Payroll inspection .....	2-5

# MAKING DAVIS-BACON WORK

*A Contractor’s Guide  
to Prevailing  
Wage Requirements  
for Federally-Assisted  
Construction Projects*



# MAKING DAVIS-BACON WORK

<b>2-4 Davis-Bacon Definitions</b> .....	2-5
a. Laborer or mechanic .....	2-5
b. Employee .....	2-5
c. Apprentices and trainees .....	2-5
d. Prevailing wages or wage rates .....	2-6
e. Fringe benefits .....	2-7
f. Overtime .....	2-7
g. Deductions .....	2-7
h. Proper designation of trade .....	2-8
i. Site of work .....	2-8

## SECTION II — REPORTING REQUIREMENTS

<b>2-5 Completing a Payroll Report</b> .....	2-8
a. Project and contractor/subcontractor information .....	2-9
b. Employee information .....	2-9
c. Work classification .....	2-9
d. Hours worked .....	2-9
e. Rate of pay .....	2-9
f. Gross wages earned .....	2-10
g. Deductions .....	2-10
h. Net pay .....	2-10
i. Statement of compliance .....	2-10
j. Signature .....	2-11

## SECTION III — PAYROLL REVIEWS AND CORRECTIONS

<b>2-6 Compliance Reviews</b> .....	2-11
a. On-site interviews .....	2-11
b. Project payroll reviews .....	2-11
<b>2-7 Typical Payroll Errors and Required Corrections.</b> .....	2-11
a. Inadequate payroll information .....	2-12
b. Missing addresses and Social Security Numbers .....	2-12
c. Incomplete payrolls .....	2-12
d. Classifications .....	2-12
e. Wage rates .....	2-12
f. Apprentices and trainees .....	2-12
g. Overtime .....	2-12
h. Computations .....	2-13
i. Deductions .....	2-13
j. Fringe benefits .....	2-13
k. Signature .....	2-13
l. On-site interview comparisons .....	2-13



*A Contractor's Guide  
to Prevailing  
Wage Requirements  
for Federally-Assisted  
Construction Projects*

**2-8 Restitution for Underpayment of Wages** ..... 2-13

- a. Notification to the employer/prime contractor ..... 2-13
- b. Computing wage restitution ..... 2-14
- c. Correction payrolls ..... 2-14
- d. Review of correction CPR ..... 2-14
- e. Unfound workers ..... 2-14

**CHAPTER 3.  
Labor Standards Disputes, Administrative Reviews,  
Withholding, Deposits and Escrow Accounts, and  
Sanctions**

**3-1 Introduction** ..... 3-1

**3-2 Administrative Review on  
Labor Standards Disputes** ..... 3-1

- a. Additional classifications and wage rates ..... 3-1
- b. Findings of underpayment ..... 3-2

**3-3 Withholding** ..... 3-2

**3-4 Deposits and Escrow Accounts** ..... 3-3

**3-5 Administrative Sanctions** ..... 3-4

- a. DOL debarment ..... 3-4
- b. HUD sanctions ..... 3-4

**3-6 Falsification of Certified Payroll Reports** ..... 3-4

**Index** ..... A-1

**Acronyms and Symbols** ..... A-3

**Davis-Bacon – Related Web Sites** ..... A-3

**Exhibits**

- HUD-4720, Project Wage Rate Sheet ..... A-4
- WH-347, Payroll Form ..... A-5
- Statement of Compliance ..... A-6



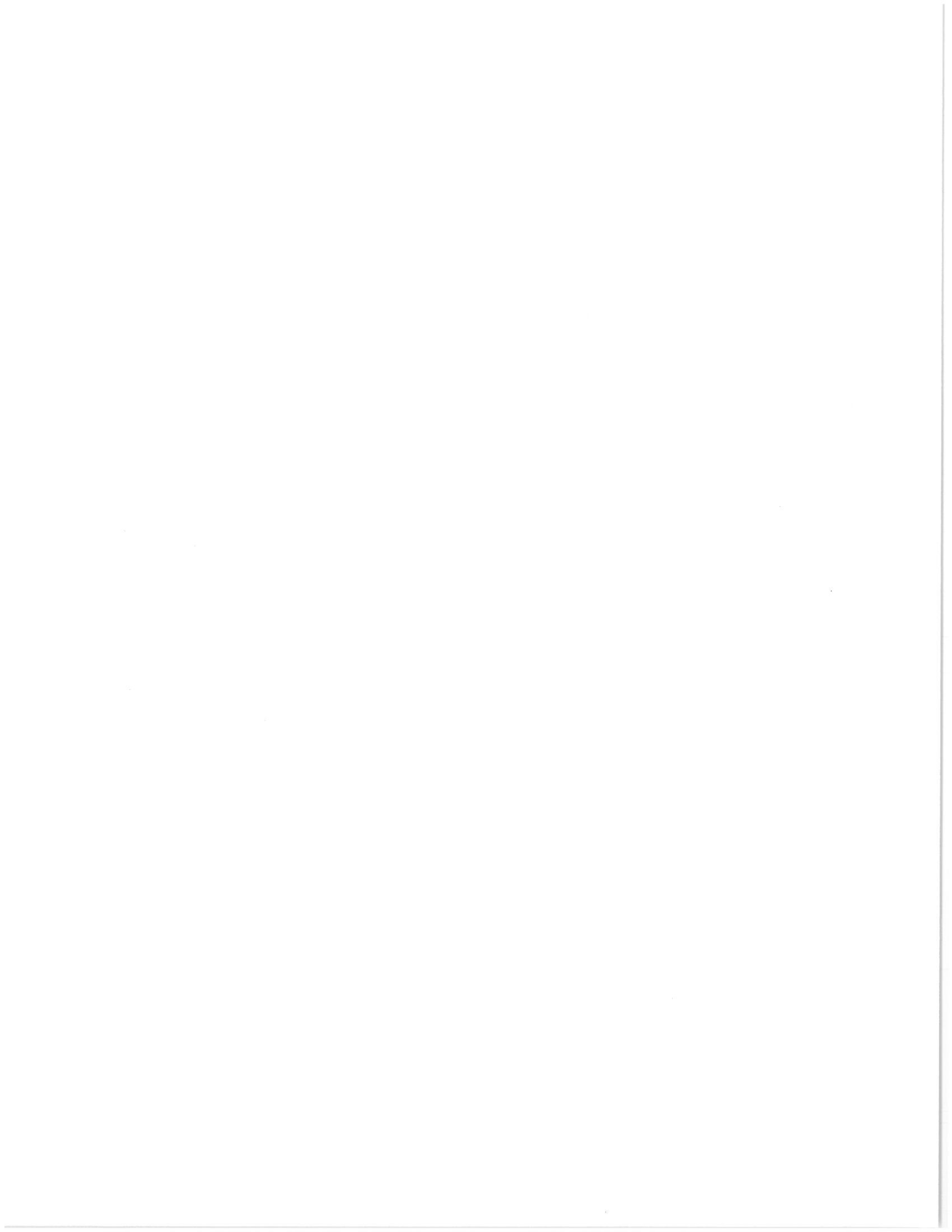

# CHAPTER I.

## Laws, Regulations, Contracts and Responsibilities

The following paragraphs describe what the labor standards laws and regulations actually say and what they mean to you on HUD projects:

### I-1 Davis-Bacon and Other Labor Laws

#### a. The Davis-Bacon Act (DBA)

The Davis-Bacon Act requires the payment of prevailing wage rates (which are determined by the U.S. Department of Labor) to all laborers and mechanics on Federal government and District of Columbia construction projects in excess of \$2,000. Construction includes alteration and/or repair, including painting and decorating, of public buildings or public works.

Most HUD construction work *is not* covered by the DBA itself since HUD seldom contracts directly for construction services. Most often, if Davis-Bacon wage rates apply to a HUD project it is because of a labor provision contained in one of HUD's "Related Acts" such as the U.S. Housing Act of 1937, the National Housing Act, the Housing and Community Development Act of 1974, the National Affordable Housing Act of 1990, and the Native American Housing Assistance and Self-Determination Act of 1996. The Related Acts are often referred to as the **Davis-Bacon and Related Acts or DBRA**.

#### b. The Contract Work Hours and Safety Standards Act (CWHSSA)

CWHSSA requires time and one-half pay for overtime (O/T) hours (over 40 in any workweek) worked on the covered project. The CWHSSA applies to both direct Federal contracts and to indirect Federally-assisted contracts **except** where the assistance is solely in the nature of a loan guarantee or insurance. CWHSSA violations carry a liquidated damages penalty (\$10/day per violation). Intentional violations of CWHSSA standards can be considered for Federal criminal prosecution.

CWHSSA does not apply to *prime contracts* of \$100,000 or less. In addition, some HUD projects are not covered by CWHSSA because some HUD programs only provide loan guarantees or insurance. CWHSSA also does not apply to construction or rehabilitation contracts that are not subject to Federal prevailing wage rates (e.g., Davis-Bacon wage rates, or HUD-determined rates for operation of public housing and Indian block grant-assisted housing). However, even though CWHSSA overtime pay is not required, Fair Labor Standards Act (FLSA) overtime pay is probably still applicable. (See also Labor Relations Letter SL-95-01, *CWHSSA Coverage threshold for overtime and health and safety provisions*, available on-line at the HUD Labor Relations Library at: [www.hud.gov/offices/olr/library.cfm](http://www.hud.gov/offices/olr/library.cfm))

## MAKING DAVIS-BACON WORK

*A Contractor's Guide  
to Prevailing  
Wage Requirements  
for Federally-Assisted  
Construction Projects*



# MAKING DAVIS-BACON WORK

## c. The Copeland Act (Anti-Kickback Act)

The Copeland Act makes it a Federal crime for anyone to require any laborer or mechanic (employed on a Federal or Federally-assisted project) to **kickback** (i.e., give up or pay back) any part of their wages. The Copeland Act requires every employer (contractors and subcontractors) to submit weekly certified payroll reports (CPRs) and regulates permissible payroll deductions.

## d. The Fair Labor Standards Act (FLSA)

The FLSA contains Federal minimum wage rates, overtime (O/T), and child labor requirements. These requirements generally apply to any labor performed. The DOL has the authority to administer and enforce FLSA. HUD will refer to the DOL any possible FLSA violations that are found on HUD projects.

## I-2 Davis-Bacon Regulations

The Department of Labor (DOL) has published rules and instructions concerning Davis-Bacon and other labor laws in the Code of Federal Regulations (CFR). These regulations can be found in **Title 29 CFR Parts 1, 3, 5, 6 and 7**. *Part 1* explains how the DOL establishes and publishes DBA wage determinations (*aka wage decisions*) and provides instructions on how to use the determinations. *Part 3* describes Copeland Act requirements for payroll deductions and the submission of weekly certified payroll reports. *Part 5* covers the labor standards provisions that are in your contract relating to Davis-Bacon Act wage rates and the responsibilities of contractors and contracting agencies to administer and enforce the provisions. *Part 6* provides for administrative proceedings enforcing Federal labor standards on construction and service contracts. Last, *Part 7* sets parameters for practice before the Administrative Review Board. These regulations are used as the basis for administering and enforcing the laws.

DOL Regulations are available on-line on the World Wide Web:  
[http://www.dol.gov/dol/allcfr/Title\\_29/toc.htm](http://www.dol.gov/dol/allcfr/Title_29/toc.htm)

## I-3 Construction Contract Provisions

Each contract subject to Davis-Bacon labor standards requirements must contain labor standards clauses and a Davis-Bacon wage decision. These documents are often bound into the contract specifications.

### a. The Labor Standards Clauses

The labor standards clauses describe the responsibilities of the contractor concerning Davis-Bacon wages and obligate the contractor to comply with the labor requirements. The labor standards clauses also provide for remedies in the event of violations, including withholding from payments due to the contractor to ensure the payment of wages or liquidated damages which may be found due. These contract clauses enable the contract administrator to enforce the Federal labor standards applicable to the project. HUD has standard forms that contain contract clauses. For example, the HUD-2554, Supplementary Conditions to the Contract for Construction, which is issued primarily for FHA multifamily housing and other construction projects administered by HUD; the HUD-4010, Federal Labor Standards Provisions, which is used for CDBG and HOME projects, and the HUD-5370, General Conditions of the Contract for Construction – Public and Indian Housing Program.

HUD program labor standards forms are available on-line at:  
[www.hudclips.org/cgi/index.cgi](http://www.hudclips.org/cgi/index.cgi)



**b. Davis-Bacon Wage Decisions**

The Davis-Bacon wage decision (or wage determination) is a listing of various construction work classifications, such as Carpenter, Electrician, Plumber and Laborer, and the minimum wage rates (and fringe benefits, where prevailing) that people performing work in those classifications must be paid.

Davis-Bacon wage decisions are established by the DOL for various types of construction (e.g., residential, heavy, highway) and apply to specific geographic areas, usually a county or group of counties. Wage decisions are modified from time to time to keep them current. In most cases, when the contract is awarded or when construction begins, the wage decision is "locked-in" and no future modifications are applicable to the contract or project involved.

All current Davis-Bacon wage decisions can be accessed on-line at no cost at:

[www.wdol.gov](http://www.wdol.gov)

**I-4 Responsibility of the Principal Contractor**

The principal contractor (also referred to as the *prime or general contractor*) is responsible for the full compliance of all employers (the contractor, subcontractors and any lower-tier subcontractors) with the labor standards provisions applicable to the project. Because of the contractual relationship between a prime contractor and his/her subcontractors, subcontractors generally should communicate with the contract administrator only through the prime contractor. (See *Contract Administrator, below.*)

To make this Guide easier to understand, the term "*prime contractor*" will mean the principal contractor; "*subcontractor*" will mean all subcontractors including lower-tier subcontractors; and the term "*employer*" will mean all contractors as a group, including the prime contractor and any subcontractors and lower-tier subcontractors.

**I-5 Responsibility of the Contract Administrator**

The *contract administrator* is responsible for the proper administration and enforcement of the Federal labor standards provisions on contracts covered by Davis-Bacon requirements. We use this term to represent the person (or persons) who will provide labor standards advice and support to you and other project principals (e.g., the owner, sponsor, architect), including providing the proper Davis-Bacon wage decision (see ¶12-1, *The Wage Decision*) and ensuring that the wage decision and contract clauses are incorporated into the contract for construction. The contract administrator also monitors labor standards compliance (see ¶12-6, *Compliance Reviews*) by conducting interviews with construction workers at the job site and reviewing payroll reports, and oversees any enforcement actions that may be required.

The contract administrator could be an employee or agent of HUD, or of a city or county or public housing agency. *For HUD projects administered directly by HUD staff, usually FHA-insured multifamily projects, the contract administrator will be the HUD Labor Relations field staff.* But many HUD-assisted projects are administered by local contracting agencies such as Public Housing Agencies (PHAs),



# MAKING DAVIS-BACON WORK

Indian tribes and tribally-designated housing entities (TDHEs), and States, cities and counties under HUD's Community Development Block Grant (CDBG) and HOME programs. In these cases, the *contract administrator* will likely be local agency staff. In either case, the guidance for you remains essentially the same.

The DOL also has a role in monitoring Davis-Bacon administration and enforcement. In addition, DOL has independent authority to conduct investigations. A DOL investigator or other DOL representative may visit Davis-Bacon construction sites to interview construction workers or review payroll information.



## CHAPTER 2. How to Comply with Labor Standards and Payroll Reporting Requirements

### Where to start?

Now that you know you're on a Davis-Bacon project and you know some of the legal and practical implications, what's next?

### SECTION I — THE BASICS

#### 2-1 The Wage Decision

Davis-Bacon labor standards stipulate the wage payment requirements for *Carpenters, Electricians, Plumbers, Roofers, Laborers, and other construction work classifications* that may be needed for the project. The **Davis-Bacon wage decision** that applies to the project contains a schedule of work classifications and wage rates that must be followed. If you don't have it already (and by now you should), you'll want to get a copy of the applicable **Davis-Bacon wage decision**.

Remember, the wage decision is contained in the contract specifications along with the labor standards clauses. See ¶1-3, *Construction Contract Provisions*.

##### a. The Work Classifications and Wage Rates

A Davis-Bacon wage decision is simply a listing of different work classifications and the minimum wage rates that must be paid to anyone performing work in those classifications. You'll want to make sure that the work classification(s) you need are contained in the wage decision and make certain you know exactly what wage rate(s) you will need to pay. Some wage decisions cover several counties and/or types of construction work (for example, residential and commercial work) and can be lengthy and difficult to read. Contact the *contract administrator* (HUD Labor Relations field staff or local agency staff) if you have any trouble reading the wage decision or finding the work classification(s) you need.

To make reading lengthy wage decisions easier for you, the contract administrator may prepare a Project Wage Rate Sheet (HUD-4720). This Sheet is a one-page transcript that will show only the classifications and wage rates for a particular project. A blank copy of a Project Wage Rate Sheet is provided for you in the appendix. Also, a fillable version of this form is available on-line at HUDClips (see web address in the Appendix). Contact the contract administrator monitoring your project for assistance with a Project Wage Rate Sheet.



# MAKING DAVIS-BACON WORK

## b. Posting the Wage Decision

If you are the prime contractor, you will be responsible for posting a copy of the wage decision (or the Project Wage Rate Sheet) and a copy of a DOL poster called *Notice to All Employees* (Form WH-1321) at the job site in a place that is easily accessible to all of the construction workers employed at the project and where the wage decision and poster won't be destroyed by wind or rain, etc. The *Notice to All Employees* poster is available on-line at HUDClips (see address in the Appendix).

## 2-2 Additional "Trade" Classifications and Wage Rates

**What if the work classification you need isn't on the wage decision?** If the work classification(s) that you need doesn't appear on the wage decision, you will need to request an **additional classification and wage rate**. This process is usually very simple and you'll want to start the request right away. Basically, you identify the classification you need and recommend a wage rate for DOL to approve for the project. There are a few rules about additional classifications; you'll find these rules in the DOL regulations, Part 5, and in the labor clauses in your contract. The rules are summarized for you here:

### a. Additional Classification Rules

Additional classifications and wage rates can be approved if:

- 1) The requested classification is used by construction contractors in the area of the project. (The area is usually defined as the *county* where the project is located).
- 2) The work that will be performed by the requested classification is not already performed by another classification that is already on the wage decision. (In other words, if there already is an Electrician classification and wage rate on the wage decision you can't request another Electrician classification and rate.)
- 3) The proposed wage rate for the requested classification "fits" with the other wage rates already on the wage decision. (For example, the wage rate proposed for a trade classification such as Electrician must be at least as much as the lowest wage rate for other trade classifications already contained in the wage decision.) And,
- 4) The workers that will be employed in the added classification (if it is known who the workers are/will be), or the workers' representatives, must agree with the proposed wage rate.

### b. Making the Request

A request for additional classification and wage rate must be made in writing through the contract administrator. (If the contract administrator is a local agency, the agency will send the request to the HUD Labor Relations staff.) If you are a subcontractor, your request should also go through the prime contractor. All you need to do is identify the work classification that is missing and recommend a wage rate (usually the rate that employer is already paying to the employees performing the work) for that classification. You may also need to describe the work that the new classification will perform.



**c. HUD Review**

The HUD Labor Relations field staff will review the requested classification and wage rate to determine whether the request meets the DOL rules outlined in paragraph 2-2(a), above. If additional information or clarification is needed, the staff will contact the prime contractor (or contract administrator for local agency projects) for more information, etc. If the Labor Relations review finds that the request meets the rules, the staff will give preliminary approval on the request and refer it to the DOL for final approval. The staff will send to you a copy of the preliminary approval/referral letter to the DOL.

If the HUD Labor Relations staff doesn't think the request meets the rules and if agreement can't be reached on the proper classification or wage rate for the work described, the HUD Labor Relations staff will *not* approve the request. In this case, the staff will send your request to the DOL with an explanation why HUD believes that the request shouldn't be approved. The DOL still has final decision authority. You will receive a copy of the disapproval/referral letter to the DOL.

**d. DOL Decision**

The DOL will respond to HUD Labor Relations in writing about the additional classification and wage rate request. HUD Labor Relations will notify you of the DOL decision in writing. If the DOL approves the request, the prime contractor must post the approval notice on the job site with the wage decision.

If the DOL *does not* approve the request, you will be notified about what classification and wage rate should be used for the work in question. You will also receive instructions about how to ask for DOL reconsideration if you still want to try to get your recommendation approved.

It's always a good idea to talk to the contract administrator before submitting an additional classification and wage rate request. The contract administrator can offer suggestions and advice that may save you time and increase the likelihood that DOL will approve your request. Usually, the contract administrator can give you an idea about what the DOL will finally decide.

**2-3 Certified Payroll Reports**

You'll need to submit a weekly certified payroll report (CPR) beginning with the first week that your company works on the project and for every week afterward until your firm has completed its work. It's always a good idea to number the payroll reports beginning with #1 and to clearly mark your last payroll for the project "Final."

**a. Payroll Formats**

The easiest form to use is DOL's WH-347, **Payroll**. A sample copy of the WH-347 is included in the back of this Guide. You may access a fillable version of the WH-347 on-line at HUDClips (see web address in the Appendix). Also, the contract administrator can provide a few copies of the WH-347 that you can reproduce.

You are *not required* to use Payroll Form WH-347. You are welcome to use any other type of payroll, such as computerized formats, as long as it contains all of the information that is required on the WH-347.



# MAKING DAVIS-BACON WORK

If you number your payroll reports consecutively, you *do not* need to submit “no work” payrolls!

## b. Payroll Certifications

The weekly payrolls are called *certified* because each payroll is signed and contains language certifying that the information is true and correct. The payroll **certification** language is on the reverse side of the WH-347. If you are using another type of payroll format you may attach the certification from the back of the WH-347, or any other format which contains the same certification language on the WH-347 (reverse).

DOL's website has Payroll Instructions, and the Payroll Form WH-347, in a “fillable” PDF format at this address:  
[www.dol.gov/esa/programs/dbra/forms.htm](http://www.dol.gov/esa/programs/dbra/forms.htm) and at HUDClips.

## c. “No Work” Payrolls

“No work” payrolls may be submitted whenever there is a temporary break in your work on the project, for example, if your firm is not needed on the project right now but you will be returning to the job in a couple of weeks. (See *Tip Box, below, for “no work” payroll exemption!*) However, if you know that your firm will not be working on the project for an extended period of time, you may wish to send a short note to the contract administrator to let them know about the break in work and to give an approximate date when your firm will return to the project. If you send a note, you do not need to send “no work” payrolls.

## d. Payroll Review and Submission

The prime contractor should **review** each subcontractor's payroll reports for compliance **prior** to submitting the reports to the contract administrator. Remember, the prime contractor is responsible for the full compliance of all subcontractors on the contract and will be held accountable for any wage restitution that may be found due to any laborer or mechanic that is underpaid *and* for any liquidated damages that may be assessed for overtime violations. All of the payroll reports for any project must be submitted to the contract administrator *through* the prime contractor.

An alert prime contractor that reviews subcontractor payroll submissions can detect any misunderstandings early, prevent costly underpayments and protect itself from financial loss should underpayments occur.

## e. Payroll Retention

Every contractor (including every subcontractor) must keep a complete set of their own payrolls and other basic records such as time cards, tax records, evidence of fringe benefit payments,



for a Davis-Bacon project for at least 3 years after the project is completed. The prime contractor must keep a complete set of all of the payrolls for every contractor (including subcontractors) for at least 3 years after completion of the project.

**f. Payroll Inspection**

In addition to submitting payrolls to the contract administrator, every contractor (including subcontractors) must make their own copy of the payrolls and other basic records available for review or copying to any authorized representative from HUD or from DOL.

**2-4 Davis-Bacon Definitions**

Before we discuss how to complete the weekly payroll forms, we need to review a couple of definitions. These definitions can help you understand what will be required of you:

**a. Laborer or Mechanic**

“Laborers” and “mechanics” mean anyone who is performing construction work on the project, including trade journeymen (carpenters, plumbers, sheet metal workers, etc.), apprentices, trainees and, for CWHSSA purposes, watchmen and guards. “Laborers” and “mechanics” are the two groups of workers that must be paid not less than Davis-Bacon wage rates.

- 1) **Working foremen.** Foremen or supervisors that regularly spend **more** than 20% of their time performing construction work and do not meet the exclusions in paragraph 2 below are covered “laborers” and “mechanics” for labor standards purposes for the time spent performing construction work.
- 2) **Exclusions.** People whose duties are primarily administrative, executive or clerical are not laborers or mechanics. Examples include superintendents, office staff, timekeepers, messengers, etc. (Contact the contract administrator if you have any questions about whether a particular employee is excluded.)

**b. Employee**

Every person who performs the work of a laborer or mechanic is “employed” regardless of any contractual relationship which may be alleged to exist between a contractor or subcontractor and such person. This means that even if there is a contract between a contractor and a worker, the contractor must make sure that the worker is paid at least as much as the wage rate on the wage decision for the classification of work they perform. Note that there are no exceptions to the prevailing wage requirements for relatives or for self-employed laborers and mechanics.

**c. Apprentices and Trainees**

The only workers who can be paid less than the wage rate on the wage decision for their work classification are “apprentices” and “trainees” registered in approved apprenticeship or training

For more information about working sub-contractors, ask the contract administrator or your HUD Labor Relations Field Staff for a copy of Labor Relations Letter LR-96-01, *Labor standards compliance requirements for self-employed laborers and mechanics*. Labor Relations Letters and other helpful Labor Relations publications are available at HUD's Labor Relations web site (see the list of web site addresses in the *Appendix*).



# MAKING DAVIS-BACON WORK

programs, including *Step-Up* apprenticeship programs designed for Davis-Bacon construction work. Approved programs are those which have been registered with the DOL or a DOL-recognized State Apprenticeship Council (SAC). Apprentices and trainees are paid wage rates in accordance with the wage schedule in the approved program.

Most often, the apprentice/trainee wage rate is expressed as a series of percentages tied to the amount of time spent in the program. For example, 0-6 months: 65%; 6 months – 1 year: 70%; etc. The percentage is applied to the journeyman's wage rate. On Davis-Bacon projects, the percentage must be applied to the journeyman's wage rate *on the applicable wage decision* for that craft.

- 1) **Probationary apprentice.** A "probationary apprentice" can be paid as an apprentice (less than the rate on the wage decision) if the DOL or SAC has certified that the person is eligible for probationary employment as an apprentice.
- 2) **Pre-apprentice.** A "pre-apprentice", that is, someone who is not registered in a program and who hasn't been DOL- or SAC-certified for probationary apprenticeship is **not** considered to be an "apprentice" and must be paid the full journeyman's rate on the wage decision for the classification of work they perform.
- 3) **Ratio of apprentices and trainees to journeymen.** The maximum number of apprentices or trainees that you can use *on the job site* can not exceed the ratio of apprentices or trainees to journeymen allowed in the approved program.

#### d. Prevailing Wages or Wage Rates

Prevailing wage rates are the wage rates listed on the wage decision for the project. The wage decision will list a minimum basic hourly rate of pay for each work classification. Some wage decisions include fringe benefits which are usually listed as an hourly fringe rate. If the wage decision includes a fringe benefit rate for a classification, you will need to add the fringe benefit rate to the basic hourly rate *unless* you provide bona fide fringe benefits for your employees.

- 1) **Piece-work.** Some employees are hired on a piece-work basis, that is, the employee's earnings are determined by a factor of work produced. For example, a Drywall Hanger's earnings may be calculated based upon the square feet of sheetrock actually hung, a Painter's earnings may be based upon the number of units painted. Employers may calculate weekly earnings based upon piece rates **provided** the weekly earnings are sufficient to satisfy the wage rate requirement based upon actual hours, including any overtime, worked. *Accurate time records must be maintained for any piece-work employees.* If the weekly piece rate earnings are not sufficient, the employer must recompute weekly earnings based upon the actual hours worked and the rate on the wage decision for the work classification(s) involved.



**e. Fringe Benefits**

Fringe benefits can include health insurance premiums, retirement contributions, life insurance, vacation and other paid leave as well as some contributions to training funds. Fringe benefits **do not** include employer payments or contributions required by other Federal, State or local laws, such as the employer's contribution to Social Security or some disability insurance payments.

**Note** that the *total* hourly wage rate paid to any laborer or mechanic (basic wage or basic wage plus fringe benefits) may be no less than the total wage rate (basic wage or basic wage plus fringe benefits) on the wage decision for their craft. If the value of the fringe benefit(s) you provide is less than the fringe benefit rate on the wage decision, you will need to add the balance of the wage decision fringe benefit rate to the basic rate paid to the employee. For example, if the wage decision requires \$10/hour basic rate plus \$5/hour fringe benefits, you must pay no less than that total (\$15/hour) in the basic rate or basic rate plus whatever fringe benefit you may provide. You can meet this obligation in several ways: you could pay the base wage and fringe benefits as stated in the wage decision, or you could pay \$15 in base wage with no fringe benefits, or you could pay \$12 basic plus \$3 fringe benefits. You can also *off-set* the amount of the base wage if you pay more in fringe benefits such as by paying or \$9 basic plus \$6 fringe benefits; as long as you meet the total amount. The amount of the base wage that you may off-set with fringe benefits is limited by certain IRS and FLSA requirements.

**f. Overtime**

Overtime hours are defined as all hours worked on the contract in excess of 40 hours in any work week. Overtime hours must be paid at no less than one and one-half times the regular rate of basic pay plus the straight-time rate of any required fringe benefits.

Referring to our example above where the wage decision requiring a \$15 total wage obligation (\$10 basic wage plus \$5 fringe benefits) was met by paying \$9 base wage plus \$6 fringe benefits: Note that overtime rates must be based on one and one-half times the basic rate *as stated on the wage decision*. In the above example, the employer must pay for overtime: \$15/hr (\$9 basic + \$6 fringe) plus \$5 (one-half of \$10, the wage decision basic rate) for a total of \$20 per hour.

**g. Deductions**

You may make payroll deductions as permitted by DOL Regulations 29 CFR Part 3. These regulations prohibit the employer from requiring employees to "kick-back" (i.e., give up) any of their earnings. Allowable deductions which do not require prior DOL permission include employee obligations for income taxes, Social Security payments, insurance premiums, retirement, savings accounts, and any other legally-permissible deduction authorized by the employee. Deductions may also be made for payments on judgements and other financial obligations legally imposed against the employee.



# MAKING DAVIS-BACON WORK

## h. Proper Designation of Trade

You must select a work classification on the wage decision for each worker based on the actual type of work he/she performed and you must pay each worker no less than the wage rate on the wage decision for that classification regardless of their level of skill. In other words, if someone is performing carpentry work on the project, they must be paid no less than the wage rate on the wage decision for Carpenters even if they aren't considered by you to be fully trained as a Carpenter. **Remember**, the only people who can be paid less than the rate for their craft are apprentices and trainees registered in approved programs.

1) **Split-classification.** If you have employees that perform work in more than one trade during a work week, you can pay the wage rates specified for each work classification in which work was performed **only** if you maintain accurate time records showing the amount of time spent in each classification. If you do not maintain accurate time records, you must pay these employees the highest wage rate of all of the classifications of work performed.

## i. Site of Work

The "site of work" is where the Davis-Bacon wage rates apply. Usually, this means the boundaries of the project. "Site of work" can also include other adjacent or virtually adjacent property used by a contractor or subcontractor in the construction of the project, like a fabrication site that is dedicated exclusively, or nearly so, to the project.

## SECTION II REPORTING REQUIREMENTS

### 2-5 Completing a Payroll Report

#### What information has to be reported on the payroll form?

The weekly payroll form doesn't ask for any information that you don't already need to keep for wage payment and tax purposes. For example, you need to know each employee's **name, address** and **social security number**; his or her **work classification** (who is working for you and what do they do?), the hours worked during the week, his or her **rate of pay**, the **gross amount earned** (how much did they earn?), the amounts of any **deductions** for taxes, etc., and the **net amount paid** (how much should the paycheck be made out for?). No more information than you need to know in order to manage your work crew and make certain they are paid properly. And, certainly, no more information than you need to keep for IRS, Social Security and other tax and employment purposes.

You are required to submit certified payrolls to illustrate and document that you have complied with the prevailing wage requirements. The purpose of the contract administrator's review of your payrolls is to verify your compliance. Clearer and complete payroll reports will permit the contract administrator to complete reviews of your payroll reports quickly.

For many contractors,  
the Weekly Certified  
Payroll is the only  
Davis-Bacon paperwork  
you need to submit!



**a. Project and Contractor/Subcontractor Information**

Each payroll must identify the contractor or subcontractor's name and address, the project name and number, and the week ending date. Indicate the *week dates* in the spaces provided. Numbering payrolls is optional but strongly recommended.

**b. Employee Information**

The first payroll on which each employee appears must contain the employee's name, address and Social Security Number. Afterward, the address and Social Security Number only need to be reported if there is a change in this information.

**c. Work Classification**

Each employee must be classified in accordance with the wage decision based on the type of work they actually perform.

1) **Apprentices or Trainees.** The first payroll on which any apprentice or trainee appears must be accompanied by a copy of that apprentice's or trainee's registration in a registered or approved program. A copy of the portions of the registered or approved program pertaining to the wage rates and ratios shall also accompany the first payroll on which the first apprentice or trainee appears.

2) **Split classifications.** For an employee that worked in a split classification, make a separate entry for each classification of work performed distributing the hours of work to each classification, accordingly, and reflecting the rate of pay and gross earnings for each classification. Deductions and net pay may be based upon the total gross amount earned for all classifications.

**d. Hours Worked**

The payroll should show **ONLY** the regular and overtime hours worked on this project. Show both the daily and total weekly hours for each employee. If an employee performs work at job sites other than the project for which the payroll is prepared, those "other job" hours *should not* be reported on the payroll. In these cases, you should list the employee's name, classification, hours for this project only, the rate of pay and gross earnings for this project, and the gross earned for *all projects*. Deductions and net pay may be based upon the employee's total earnings (for all projects) for the week.

**e. Rate of Pay**

Show the basic hourly rate of pay for each employee for this project. If the wage decision includes a fringe benefit and you **do not** participate in approved fringe benefit programs, **add** the fringe benefit rate to the basic hourly rate of pay. Also list the overtime rate if overtime hours were worked.

1) **Piece-work.** For any piece-work employees, the employer **must** compute an *effective hourly rate* for each employee each week based upon the employee's piece-work earnings for that week. To compute the effective hourly rate, divide the piece-work earnings by the total number of hours worked, including consideration for any overtime hours.



# MAKING DAVIS-BACON WORK

The effective hourly rate must be reflected on the certified payroll and the hourly rate may be no less than the wage rate (including fringe benefits, if any) on the wage decision for the classification of work performed. It does not matter that the effective hourly rate changes from week-to-week, only that the rate is no less than the rate on the wage decision for the classification of work performed.

Remember, the overtime rate is computed at one and one-half times the *basic* rate of pay plus any fringe benefits. For example, if the wage decision requires \$10/hour basic plus \$5/hour fringe benefits, the overtime rate would be:  
 $(\$10 \times 1\frac{1}{2}) + \$5 = \$20/\text{hour}$ .

Only one employee authorization is needed for recurring (e.g., weekly) other deductions. Written employee authorization is not required for income tax and Social Security deductions.

## f. Gross Wages Earned

Show the gross amount of wages earned for work performed on this project. *Note:* For employees with work hours and earnings on other projects, you may show gross wages for this project over gross earnings all projects (for example, \$425.40/\$764.85) and base deductions and net pay on the “all projects” earnings.

## g. Deductions

Show the amounts of any deductions from the gross earnings. “Other” deductions should be identified (for example, Savings Account or Loan Repayment). Any voluntary deduction (that is, not required by law or by an order of a proper authority) must be authorized in writing by the employee or provided for in a collective bargaining (union) agreement. A short note signed by the employee is all that is needed and should accompany the first payroll on which the other deduction appears.

## h. Net Pay

Show the net amount of wages paid.

## i. Statement of Compliance

The Statement of Compliance is the certification. It is located on the reverse side of a standard payroll form (WH-347). Be sure to complete the identifying information at the top, particularly if you are attaching the Statement of Compliance to an alternate payroll form such as a computer payroll. Also, you must check either 4(a) or 4(b) if the wage decision contains a fringe benefit. Checking 4(a) indicates that you are paying required fringe benefits to approved plans or programs; and 4(b) indicates that you are paying any required fringe benefit amounts directly to the employee by adding the fringe benefit rate to the basic hourly rate of pay. If you are paying a portion of the required fringe benefit to programs and the balance directly to the employee, explain those differences in box 4(c).

Only one Statement of Compliance is required for each employer’s weekly payroll no matter how many pages are needed to report the employee data.



**j. Signature**

Make sure the payroll is **signed** with an original signature. The payroll must be signed by a principal of the firm (owner or officer such as the president, treasurer or payroll administrator) or by an authorized agent (a person authorized by a principal in writing to sign the payroll reports). Signature authorization (for persons other than a principal) should be submitted with the first payroll signed by such an agent.

## **SECTION III PAYROLL REVIEWS AND CORRECTIONS**

### **2-6 Compliance Reviews**

The contract administrator or other inspector may visit the project site and interview some of the workers concerning their employment on the project. The DOL may also independently conduct its own reviews (see ¶11-5). In addition, the contract administrator will periodically review payrolls and related submissions, comparing the interview information to the payrolls, to ensure that the labor standards requirements have been met. You will be notified by the contract administrator if these reviews find any discrepancies or errors. You will be given instructions about what steps must be taken to correct any problems.

**a. On-Site Interviews**

Every employer (contractor, subcontractor, etc.) must make their employees available for interview at the job site with the contract administrator or other agency representative, or HUD or DOL representative. The interviews are confidential and the employee will be asked about the kind of work they perform and their rate of pay. Every effort will be made to ensure that these interviews cause as little disruption as possible to the on-going work. The interviewer will record the interview information, usually on a form HUD-11, *Record of Employee Interview*, and forward the interviews to the contract administrator.

**b. Project Payroll Reviews**

The contract administrator will compare the information on the interview forms to the corresponding payrolls to ensure that the workers are properly listed on the payrolls for the days, work classification and rate of pay. The contract administrator will also review the payroll submissions to make certain that the payrolls are complete and signed; that employees are paid no less than the wage rate for the work classification shown; apprentice and trainee certifications are submitted (where needed); employee or other authorizations for other deductions are submitted (where needed); etc.

### **2-7 Typical Payroll Errors and Required Corrections**

The following paragraphs describe common payroll errors and the corrective steps you must take.



# MAKING DAVIS-BACON WORK

## a. Inadequate Payroll Information

If an alternate payroll format used by an employer (such as some computer payrolls) is inadequate, e.g., does not contain all of the necessary information that would be on the optional form WH-347, the employer will be asked to resubmit the payrolls on an acceptable form.

## b. Missing Addresses and Social Security Numbers

If the first payroll on which an employee appears does not contain the employee's address and Social Security Number, the employer will be asked to supply the missing information. A short note providing the information is all that is needed.

## c. Incomplete Payrolls

If the information on the payroll is not complete, for example, if work classifications or rates of pay are missing, the employer will be asked to send a corrected payroll.

## d. Classifications

If the payrolls show work classifications that do not appear on the wage decision, the employer will be asked to reclassify the employees in accordance with the wage decision *or* the employer may request an **additional classification and wage rate** (See ¶12-2). If reclassification results in underpayment (i.e., the wage rate paid on the payroll is less than the rate required for the new classification), the employer will be asked to pay **wage restitution** to all affected reclassified employees. (See ¶12-8 for instructions about wage restitution.)

## e. Wage Rates

If the wage rates on the payroll are less than the wage rates on the wage decision for the work classifications reported, the employer will be asked to pay wage restitution to all affected employees.

## f. Apprentices and Trainees

If a copy of the employee's registration or the approved program ratio and wage schedule are not submitted with the first payroll on which an apprentice or trainee appears, the employer will be asked to submit a copy of each apprentice's or trainee's registration and/or the approved program ratio and wage schedule. If the ratio of apprentices or trainees to journeymen on the payroll is greater than the ratio in the approved program, the employer will be asked to pay wage restitution to any excess apprentices or trainees. Also, any apprentice or trainee that is *not* registered in an approved program must receive the journeyman's wage rate for the classification of work they performed.

## g. Overtime

If the employees did not receive at least time and one-half for any overtime hours worked on the project, the following will occur:

- 1) If the project is subject to CWHSSA overtime requirements, the employer will be asked to pay wage restitution for all overtime hours worked on the project. The employer may also be liable to the United States for liquidated damages computed at \$10 per day per violation. Or,



2) If the project is **not** subject to CWHSSA, the employer will be notified of the possible *FLSA overtime* violations. Also, the contract administrator may refer the violations to the DOL for further review.

**h. Computations**

If the payroll computations (hours worked times rate of pay) or extensions (deductions, net pay) show frequent errors, the employer will be asked to take greater care. Wage restitution may be required if underpayments resulted from the errors.

**i. Deductions**

If there are any "Other" deductions that are not identified, or if employee authorization isn't provided, or if there is any unusual (very high, or large number) deduction activity, the employer will be asked to identify the deductions, provide employee authorization or explain unusual deductions, as necessary.

HUD does not enforce or attempt to provide advice on employer obligations to make deductions from employee earnings for taxes or Social Security. However, HUD may refer to the IRS or other responsible agency copies of certified payroll reports that show wages paid in gross amounts (i.e., without tax deduction) for its review and appropriate action.

**j. Fringe Benefits**

If the wage decision contains fringe benefits but the payroll does not indicate how fringe benefits were paid [neither 4(a) nor 4(b) is marked on the Statement of Compliance], the employer may be asked to submit corrected payrolls **and** will be required to pay wage restitution if underpayments occurred. *However*, if the basic hourly rates for the employees are at least as much as the total wage rate on the wage decision (basic hourly rate *plus* the fringe benefit rate), no correction is necessary.

**k. Signature**

If the payroll *Statement of Compliance* is not signed or is missing, the employer will be asked to submit a signed Statement of Compliance for each payroll affected. If the Statement of Compliance is signed by a person who is not a principal of the firm and that person has not been authorized by principal to sign, the employer will be asked to provide an authorization or to resubmit the Statement(s) of Compliance bearing the signature(s) of a principal or other signatory.

**l. On-Site Interview Comparisons**

If the comparison of on-site interviews to the payrolls indicates any discrepancies (for example, the employee does not appear on the payroll for the date of the interview), the employer will be asked to submit a corrected payroll report.

**2-8 Restitution for Underpayment of Wages**

Where underpayments of wages have occurred, the employer will be required to pay wage restitution to the affected employees. Wage restitution must be paid promptly in the full amounts due, less permissible and authorized deductions.

**a. Notification to the Employer/Prime Contractor**

The contract administrator will notify the employer and/or prime contractor in writing of any underpayments that are found during



# MAKING DAVIS-BACON WORK

The contract administrator may communicate directly with a subcontractor when the underpayments are plainly evident and the subcontractor is cooperative. It is best to work through the prime contractor when the issues are complex, when there are significant underpayments and/or the subcontractor is not cooperative. In all cases, the subcontractor must ensure that the prime contractor receives a copy of the required corrective documentation.

In most cases, HUD no longer requires employers to submit checks or copies of checks (certified, cashiers, canceled or other) to correct underpayments. Restitution payments are reported and certified by the employer on a correction payroll.

payroll or other reviews. The contract administrator will describe the underpayments and provide instructions for computing and documenting the restitution to be paid. The employer/prime contractor is allowed 30 days to correct the underpayments. Note that the prime contractor is responsible to the contract administrator for ensuring that restitution is paid. If the employer is a subcontractor, the subcontractor will usually make the computations and restitution payments and furnish the required documentation through the prime contractor.

## **b. Computing Wage Restitution**

Wage restitution is simply the difference between the wage rate paid to each affected employee and the wage rate required on the wage decision for all hours worked where underpayments occurred. The difference in the wage rates is called the *adjustment rate*. The adjustment rate times the number of hours involved equals the gross amount of restitution due. You may also compute wage restitution by calculating the total amount of Davis-Bacon wages earned and subtracting the total amount of wages paid. The difference is the amount of back wages due.

## **c. Correction Payrolls**

The employer will be required to report the restitution paid on a correction certified payroll. The correction payroll will reflect the period of time for which restitution is due (for example, Payrolls #1 through #6; or a beginning date and ending date). The correction payroll will list each employee to whom restitution was paid and their work classification; the total number of work hours involved (daily hours are usually not applicable for restitution); the adjustment wage rate (the difference between the required wage rate and the wage rate paid); the gross amount of restitution due; deductions and the net amount actually paid. A signed Statement of Compliance must be attached to the correction payroll.

## **d. Review of Correction CPR**

The contract administrator will review the correction certified payroll to ensure that full restitution was paid. The prime contractor shall be notified in writing of any discrepancies and will be required to make additional payments, if needed, documented on a supplemental correction payroll within 30 days.

## **e. Unfound Workers**

Sometimes, wage restitution cannot be paid to an affected employee because, for example, the employee has moved and can't be located. After wage restitution has been paid to all of the workers who could be located, the employer must submit a list of any workers who could not be found and paid (i.e., unfound workers) providing their names, Social Security Numbers, last known addresses and the gross amount due. In such cases, at the end of the project the prime contractor will be required to place in a deposit or escrow account an amount equal to the total amount of restitution that could not be paid because the employee(s) could not be located. The contract administrator will continue attempts to locate the unfound workers for 3 years after the completion of the project. After 3 years, any amount remaining in the account for unfound workers will be credited and/or forwarded by the contract administrator to HUD.



## **CHAPTER 3. Labor Standards Disputes, Administrative Reviews, Withholding, Deposits and Escrow Accounts, and Sanctions**

**W**hat happens when things go wrong?

### **3-1 Introduction**

Even in the best of circumstances, things can go wrong. In a Davis-Bacon context, “things going wrong” usually means there’s a difference of opinion or a dispute about whether and to what extent underpayments have occurred. These disputes are usually between the contract administrator and one or more employers (the prime contractor and/or a subcontractor). The dispute may involve something simple such as an additional classification request that is pending before the DOL; or something as significant as investigative findings following a complaint of underpayment. This chapter discusses some of what you may expect and what you can do to make your views known and to lessen any delays in resolving the problem or issue.

### **3-2 Administrative Review on Labor Standards Disputes**

As mentioned in the Introduction above, a dispute about labor standards and compliance can arise for a number of reasons. The labor standards clauses in your contract and DOL regulations provide for administrative review of issues where there is a difference of views between the contract administrator and any employer. The most common circumstances include:

#### **a. Additional Classifications and Wage Rates**

Additional classification and wage rate requests are sometimes denied by the DOL. An employer that is dissatisfied with the denial can request reconsideration by the DOL Wage and Hour Administrator. The employer may continue to pay the wage rate, as requested, until a final decision is rendered on the matter. When the final decision is known, the employer will be required to pay any additional wages that may be necessary to satisfy the wage rate that is established.

- 1) **Reconsideration.** The DOL normally identifies the reasons for denial in its response to the request. Any interested person (*for example*, the contract administrator, employer, representatives of the employees) may request reconsideration of the decision on the additional classification request. The request for reconsideration must be made in writing and must thoroughly



# MAKING DAVIS-BACON WORK

address the denial reasons identified by the DOL. Employer requests for reconsideration should be made through the contract administrator but may be made directly to the DOL. (See ¶12-2(d), and also DOL Regulations 29 CFR 1.8.) All requests initiated by or made through the contract administrator or HUD must be submitted through the HUD Headquarters Office of Labor Relations.

- 2) **Administrative Review Board.** Any interested party may request a review of the Administrator's decision on reconsideration by **DOL's Administrative Review Board**. DOL regulations 29 CFR Part 7 explain the procedures for such reviews. (See also 29 CFR 1.9.)

## b. Findings of Underpayment

Compliance reviews and other follow-up enforcement actions may result in findings of underpayment. The primary goal in every case and at every step in this process is to reach agreements about who may have been underpaid and how much wage restitution may be due and, of course, to promptly deliver restitution to any underpaid workers. The contract administrator will usually work informally with you to reach such agreements. You will have an opportunity to provide additional information to the contract administrator that may explain apparent inconsistencies and/or resolve the discrepancies.

If informal exchanges do not result in agreement, the final determination and schedule of back wages due will be presented to you in writing and you will be permitted 30 days in which to correct the underpayment(s) or to request a hearing on the matter before the DOL. The request for hearing must be made in writing through the contract administrator and must explain what findings are in dispute and the reasons. In such cases, HUD is required to submit a report to DOL for review and further consideration. All requests for DOL hearing must be submitted through the HUD Headquarters Office of Labor Relations.

- 1) **DOL review.** The DOL will review the contract administrator's report and the arguments against the findings presented in the hearing request. The DOL may affirm or modify the findings based upon the materials presented. You will be notified in writing by the DOL of the results of its review; you will be given an opportunity to correct any underpayments or to request a hearing before a DOL Administrative Law Judge (ALJ). (See DOL Regulations 29 CFR 5.11 (b) and 29 CFR Part 6, Rules of Practice for Administrative Proceedings.)
- 2) **Administrative Review Board.** Contractors and/or subcontractors may request a review by the Administrative Review Board of the decision(s) rendered by the DOL ALJ in the administrative hearing process. See DOL regulations 29 CFR Part 7 for more information about this proceeding.

## 3-3 Withholding

The contract administrator shall cause withholding from payments due to the prime contractor to ensure the payment of wages which are



believed to be due and unpaid, for example, if wage underpayments or other violations are not corrected within 30 days after notification to the prime contractor. DOL may also direct the withholding of contract payments for alleged wage underpayments. Withholding is considered to be serious and is not taken unless warranted. If withholding is deemed necessary, you will be notified in writing. Only the amounts needed to meet the contractor's (and/or subcontractors') liability shall be withheld.

Remember, the prime contractor is responsible and will be held liable for any wage restitution that is due to any worker employed in the construction of the project, including workers employed by subcontractors and any lower-tier subcontractors. See ¶1-4, *Responsibility of the Principal Contractor*, and ¶12-8, *Restitution for Underpayment of Wages*.

### 3-4 Deposits and Escrows

In every case, we attempt to complete compliance actions and resolve any disputes before the project is completed and final payments are made. Sometimes, corrective actions or disputes continue after completion and provisions must be made to ensure that funds are available to pay any wage restitution that is ultimately found due. In these cases, we allow projects to proceed to final closing and payments **provided** the prime contractor deposits an amount equal to the potential liability for wage restitution and liquidated damages, if necessary, in a special account. The deposit or *escrow account* is controlled by the contract administrator. When a final decision is rendered, the contract administrator makes disbursements from the account in accordance with the decision. Deposit/escrow accounts are established for one or more of the following reasons:

- a. **Where the parties have agreed to amounts of wage restitution that are due** but the employer hasn't furnished evidence yet that all of the underpaid workers have received their back wages, e.g., some of the workers have moved and could not be located. The amount of the deposit is equal to the total amount of restitution due to workers lacking payment evidence. As these workers are paid and proper documentation is provided to the contract administrator, amounts corresponding to the documented payments are returned to the depositor. Amounts for any workers who can not be located are held in the deposit/escrow account for three years and disbursed as described in ¶12-8(e) of this Guide.
- b. **Where underpayments are suspected or alleged and an investigation has not yet been completed.** The deposit is equal to the amount of wage restitution and any liquidated damages, if applicable, that are estimated to be due. If the final determination of wages due is less than the amount estimated and placed in the escrow account, the escrow will be reduced to the final amount and the difference will be returned to the depositor. If the parties agree to the investigative findings, the amounts due to the workers will be disbursed from the escrow account in accordance with the schedule of wages due. Amounts for unfound workers will be retained as described above (See ¶12-8(e) and 3-4(a)).

If the parties *do not* agree and an administrative hearing is requested, the escrow will be maintained as explained in ¶13-4(c), below.



# MAKING DAVIS-BACON WORK

- c. **Where the parties are waiting for the outcome of an administrative hearing** that has been or will be requested contesting a final determination of wages due. The deposit shall be equal to the amount of wage restitution and liquidated damages, if applicable, that have been determined due. Once a final decision is rendered, disbursements from the escrow account are made in accordance with the decision.

## 3-5 Administrative Sanctions

Contractors and/or subcontractors that violate the labor standards provisions may face administrative sanctions imposed by HUD and/or DOL.

### a. DOL Debarment

Contractors and/or subcontractors that are found by the Secretary of Labor to be in aggravated or willful violation of the labor standards provisions of the Davis-Bacon and Related Acts (DBRA) will be ineligible (**debarred**) to participate in any DBRA or Davis-Bacon Act contracts for up to 3 years. Debarment includes the contractor or subcontractor and any firm, corporation, partnership or association in which the contractor or subcontractor has a substantial interest. Debarment proceedings can be recommended by the contract administrator or can be initiated by the DOL. Debarment proceedings are described in DOL regulations 29 CFR 5.12.

### b. HUD Sanctions

HUD sanctions may include Limited Denials of Participation (LDPs), debarments and suspensions.

- 1) **LDPs.** HUD may issue to the employer a limited denial of participation (LDP) which prohibits the employer from further participation in HUD programs for a period up to one year. The LDP is usually effective for the HUD program in which the violation occurred and for the geographic jurisdiction of the issuing HUD Office. HUD regulations concerning LDP's are found at 24 CFR 24.700-24.714.
- 2) **Debarment and suspensions.** In certain circumstances, HUD may initiate its own debarment or suspension proceedings against a contractor and/or subcontractor in connection with improper actions regarding Davis-Bacon obligations. For example, HUD may initiate debarment where a contractor has been convicted for making false statements (such as false statements on certified payrolls or other prevailing wage certifications) or may initiate suspension where a contractor has been indicted for making false statements. HUD regulations concerning debarment and suspension are found at 24 CFR Part 24.

Remember, if you have any questions or need assistance concerning labor standards requirements help is always available. Contact the contract administrator for the project you're working on or the HUD Field Labor Relations staff in your area.

## 3-6 Falsification of Certified Payroll Reports

Contractors and/or subcontractors that are found to have willfully falsified payroll reports (Statements of Compliance), including correction certified payroll reports, may be subject to civil or criminal prosecution. Penalties may be imposed of \$1,000 and/or one year in prison for each false statement (see Section 1001 of Title 18 and Section 231 of Title 31 of the United States Code).



# Index

Acronyms .....	v, A-3
Additional classifications .....	iii, 2-2
Administrative Review Board .....	1-2, 3-2
Administrative Review on Labor Standards Disputes .....	v, 3-1
Apprentices .....	iv, 2-5, 2-9, 2-12
Apprentices and trainees .....	2-5
Pre-apprentice .....	2-6
Probationary apprentice .....	2-6
Ratio of apprentices and trainees to journeymen .....	2-6
Basic Hourly Rate .....	2-6, 2-9
Certified Payroll reports .....	iii, 1-2, 2-3, 2-8, 3-4
“No work” payrolls .....	2-4
Payroll certifications .....	2-4
Payroll formats .....	2-3
Payroll inspection .....	2-5
Payroll retention .....	2-4
Payroll review and submission .....	2-4
Compliance Reviews .....	2-11
Construction Contract Provisions .....	1-2
HUD-2554 .....	1-2
HUD-4010 .....	1-2
HUD-5370 .....	1-2
Labor standards clauses .....	1-2
Contract administrator .....	iii, 1-3, 2-1-2-5, 2-11, 2-14, 3-1-3-4
Contract provisions .....	iii, 1-2, 2-1
Contract Work Hours and Safety Standards Act .....	iii, 1-1, A-3
Copeland Act .....	iii, 1-2
Correction payrolls .....	v, 2-14
CPR .....	2-3, A-3
CWHSSA .....	iii, 1-1, A-3
Davis-Bacon Act .....	iii, 1-1, 1-2
Davis-Bacon Definitions .....	iv, 2-5
Apprentices and trainees .....	2-5
Fringe benefits .....	2-7
Laborer or mechanic .....	2-5
Working foremen .....	2-5
Davis-Bacon Regulations .....	iii, 1-2, A-3
Davis-Bacon Wage Decisions .....	1-3
Davis-Bacon Act .....	iii, 1-1, 1-2, 3-4, A-3
DBA .....	iii, 1-1, 1-2, 3-4, A-3
DBRA .....	1-1, 3-4, A-3
Debarment .....	v, 3-4
Deductions .....	iv, 1-2, 2-7, 2-10, 2-13, 2-14
Deposits and Escrow .....	v, 3-3
DOL .....	1-2-1-4, 2-2-2-7, 2-11, 3-1-3-4, A-3, A-5
DOL investigator .....	1-4
DOL regulations .....	2-2, 3-1-3-4, A-3
Employee .....	iv, 2-5
Fair Labor Standards Act .....	iii, 1-2, A-3
FLSA .....	A-3



# MAKING DAVIS-BACON WORK

Falsification .....	v, 3-4
Findings of underpayment .....	v, 3-2
Fringe benefits .....	iv, 1-3, 2-6, 2-7, 2-9, 2-13
Gross wages .....	iv, 2-10
HUD Home Page .....	i
HUD Labor Relations field staff .....	i, 1-3, 2-2
HUD-11 .....	2-11
Labor Relations Staff .....	i, 1-3, 2-2
Limited Denial of Participation .....	3-4, A-3
Liquidated damages .....	1-1, 2-12, 3-3
Local contracting agencies .....	1-3
Net pay .....	iv, 2-10, 2-14
Notice to Employees .....	2-2
On-site Interviews .....	2-11
Overtime .....	iv, 1-1, 1-2, 2-7, 2-9, 2-12, A-3
Payroll certification .....	iii, 2-4
Payroll errors .....	iv, 2-11
Payroll format .....	iii, 2-3, 2-12
Payroll retention .....	iii, 2-4
Payroll submissions .....	iii, 2-4
Piece-work .....	2-6, 2-9
Posting the wage decision .....	2-2
Prevailing wages or wage rates .....	2-6
Prime contractor .....	1-3, 2-2, 2-4, 2-14, 3-3
Principal contractor .....	iii, 1-3
general contractor .....	1-3
Project Wage Rate Sheet .....	2-1, A-4
Proper designation of trade .....	iv, 2-8
Rate of Pay .....	iv, 2-9, 2-11
Site of Work .....	iv, 2-8
Split-classification .....	2-8
Statement of Compliance .....	2-10, 2-13, 2-14, 3-4
Step-Up apprenticeship programs .....	2-6
Subcontractor .....	1-3, 2-2, 2-4, 3-1
lower-tier subcontractors .....	1-3
Suspension .....	3-4
Trainees .....	iv, 2-5, 2-6, 2-12
Typical Payroll Errors .....	iv, 2-11
Unfound workers .....	v, 2-14, 3-3
Wage Decision .....	iii, 1-3, 2-1-2-3, 2-6-2-14, A-4
Wage Restitution .....	v, 2-13, 2-14, 3-2-3-4
Computing wage restitution .....	v, 2-14
Correction payrolls .....	v, 2-14
Unfound workers .....	v, 2-14
Withholding .....	v, 1-2, 3-2
Work Classification .....	iv, 2-1, 2-3, 2-6, 2-8, 2-9, 2-11, 2-14
World Wide Web .....	i



## Acronyms and Symbols

CDBG	– Community Development Block Grant
CFR	– Code of Federal Regulations
CPR	– Certified Payroll Report
CWHSSA	– Contract Work Hours and Safety Standards Act
DBA	– Davis-Bacon Act
DBRA	– Davis-Bacon and Related Acts
DOL	– Department of Labor
FHA	– Federal Housing Administration
FLSA	– Fair Labor Standards Act
HUD	– Housing and Urban Development (Department of)
IHA	– Indian Housing Authority
LCA	– Local Contracting Agency
LDP	– Limited Denial of Participation
O/T	– Overtime
PHA	– Public Housing Agency
S/T	– Straight-time
SAC	– State Apprenticeship Council/Agency
TDHE	– Tribally-Designated Housing Entity
§	– Section
¶	– Paragraph

## Davis-Bacon – Related Web Sites\*

HUD Office of Labor Relations:

[www.hud.gov/offices/olr](http://www.hud.gov/offices/olr)

HUD Regulations:

[www.access.gpo.gov/nara/cfr/cfr-table-search.html](http://www.access.gpo.gov/nara/cfr/cfr-table-search.html)

HUDClips (Forms and Publications):

[www.hudclips.org/cgi/index.cgi](http://www.hudclips.org/cgi/index.cgi)

DOL Davis-Bacon and Related Acts Homepage:

[www.dol.gov/esa/programs/dbra/index.htm](http://www.dol.gov/esa/programs/dbra/index.htm)

DOL Regulations:

[www.dol.gov/dol/allcrf/Title\\_29/toc.htm](http://www.dol.gov/dol/allcrf/Title_29/toc.htm)

Davis-Bacon Wage Decisions:

[www.wdol.gov](http://www.wdol.gov)

DOL Forms:

[www.dol.gov/esa/programs/dbra/forms.htm](http://www.dol.gov/esa/programs/dbra/forms.htm)

\*Web addresses active as of June 2006



# Project Wage Rate Sheet

U.S. Department of Housing and Urban Development  
Office of Labor Relations

PROJECT NAME:	WAGE DECISION NUMBER/MODIFICATION NUMBER:
---------------	---

PROJECT NUMBER:	PROJECT COUNTY:
-----------------	-----------------

WORK CLASSIFICATION	BASIC HOURLY RATE (BHR)	FRINGE BENEFITS	TOTAL HOURLY WAGE RATE	LABORERS FRINGE BENEFITS:		\$ TOTAL WAGE
				GROUP #	BHR	
Bricklayers			\$			
Carpenters			\$			\$
Cement Masons			\$			\$
Drywall Hangers			\$			\$
Electricians			\$			\$
Iron Workers			\$			\$
Painters			\$	OPERATORS FRINGE BENEFITS:		\$
Plumbers			\$	GROUP #	BHR	TOTAL WAGE
Roofers			\$			\$
Sheet Metal Workers			\$			\$
Soft Floor Layers			\$			\$
Tapers			\$			\$
Tile Setters			\$	TRUCK DRIVERS FRINGE BENEFITS:		\$
OTHER CLASSIFICATIONS				GROUP #	BHR	TOTAL WAGE
			\$			\$
			\$			\$
			\$			\$

**ADDITIONAL CLASSIFICATIONS (HUD Form 4230-A)**

WORK CLASSIFICATION	BASIC HOURLY RATE	FRINGE BENEFITS	TOTAL HOURLY WAGE RATE	DATE OF HUD SUBMISSION TO DOL	DATE OF DOL APPROVAL
			\$		
			\$		
			\$		
			\$		



Date \_\_\_\_\_

I, \_\_\_\_\_ (Name of Signatory Party) \_\_\_\_\_ (Title)

do hereby state:

(1) That I pay or supervise the payment of the persons employed by \_\_\_\_\_ (Contractor or Subcontractor) \_\_\_\_\_ on the \_\_\_\_\_ (Building or Work)

\_\_\_\_\_ ; that during the payroll period commencing on the \_\_\_\_\_ day of \_\_\_\_\_, and ending the \_\_\_\_\_ day of \_\_\_\_\_, all persons employed on said project have been paid the full weekly wages earned, that no rebates have been or will be made either directly or indirectly to or on behalf of said \_\_\_\_\_ (Contractor or Subcontractor) \_\_\_\_\_ from the full

weekly wages earned by any person and that no deductions have been made either directly or indirectly from the full wages earned by any person, other than permissible deductions as defined in Regulations, Part 3 (29 CFR Subtitle A), issued by the Secretary of Labor under the Copeland Act, as amended (48 Stat. 948, 63 Stat. 108, 72 Stat. 967; 76 Stat. 357; 40 U.S.C. 276c), and described below:

(2) That any payrolls otherwise under this contract required to be submitted for the above period are correct and complete; that the wage rates for laborers or mechanics contained therein are not less than the applicable wage rates contained in any wage determination incorporated into the contract; that the classifications set forth therein for each laborer or mechanic conform with the work he performed.

(3) That any apprentices employed in the above period are duly registered in a bona fide apprenticeship program registered with a State apprenticeship agency recognized by the Bureau of Apprenticeship and Training, United States Department of Labor, or if no such recognized agency exists in a State, are registered with the Bureau of Apprenticeship and Training, United States Department of Labor.

(4) That: (a) WHERE FRINGE BENEFITS ARE PAID TO APPROVED PLANS, FUNDS, OR PROGRAMS

- in addition to the basic hourly wage rates paid to each laborer or mechanic listed in the above referenced payroll, payments of fringe benefits as listed in the contract have been or will be made to appropriate programs for the benefit of such employees, except as noted in Section 4(c) below.

(b) WHERE FRINGE BENEFITS ARE PAID IN CASH

- Each laborer or mechanic listed in the above referenced payroll has been paid, as indicated on the payroll, an amount not less than the sum of the applicable basic hourly wage rate plus the amount of the required fringe benefits as listed in the contract, except as noted in Section 4(c) below.

(c) EXCEPTIONS

EXCEPTION (CRAFT)	EXPLANATION

REMARKS:

NAME AND TITLE	SIGNATURE

THE WILLFUL FALSIFICATION OF ANY OF THE ABOVE STATEMENTS MAY SUBJECT THE CONTRACTOR OR SUBCONTRACTOR TO CIVIL OR CRIMINAL PROSECUTION. SEE SECTION 1001 OF TITLE 18 AND SECTION 231 OF TITLE 31 OF THE UNITED STATES CODE.

U.S. Department of Housing and Urban Development  
Office of Labor Relations  
Washington, DC 20410

Official Business  
Penalty for Private Use \$300

Return Service Requested

STANDARD MAIL  
POSTAGE & FEES PAID  
HUD  
Permit No. G-795

Labor Relations Desk Guide  
LR01.DG



**GPO** U.S. GOVERNMENT PRINTING OFFICE: 2005-321-332

4812



Border Colonia Access Program  
Checklist for Documentation Required for Road Construction

Contractor: \_\_\_\_\_  
 Contract Amount: \_\_\_\_\_  
 Project/Precinct: \_\_\_\_\_  
 Owner's Contract No.: \_\_\_\_\_

Item	Required Documents	Submitted & Reviewed	Approved	Comments:
	<b>INITIATION OF PROJECT:</b>			
1	Approval to Bid (Purchasing)			
2	Contract - Signed and Executed			
3	Gen. Liability Insurance - (Expiration Date)			
4	Automobile Liab. Insurance - (Expiration Date)			
5	Worker's Comp. & Empl. Liab. (Expiration Date)			
6	Notice to Proceed			
7	Material Sample & Testing Table Sent to Auditor's Office			
	<b>PAYMENT REQUESTS, INCLUDING FINAL:</b>			
8	Application and Certification of Payment (A)			
9	Schedule of Values a/k/a 1257/1258			
10	Estimate Quantity Update Worksheet			
11	List of Suppliers and Sub-contractors			
12	Partial Waiver of Liens (Sub-contractors/suppliers)			
13	TxDot Form 252 Contract Time Statement			
14	Payroll Report w/signed Wage Form			
15	Change Order (Requires TxDot Concurrence)			
	<b>RETAINAGE PAYMENT:</b> - Final request and request for retainage must be billed separately and approved by C.C.			
16	Punch List			
17	Certificate of Construction Completion			
18	Approval by Commissioner's Court			
19	Contractor's Affidavit of Release (Waiver) of Liens (with power of attorney)(B)			
20	Affidavit of Payment of Debts & Claims-lien bond & indemnity bonds(w/power of attorney)(B)			
21	Consent of Surety to Final Payment(with power of attorney)(B)			
22	Final Blue Prints			

## CHANGE ORDER NUMBER ONE(1)

Project: \_\_\_\_\_

DATE OF ISSUANCE: \_\_\_\_\_ EFFECTIVE DATE: \_\_\_\_\_

OWNER:  
OWNER'S CONTRACT NO: \_\_\_\_\_

CONTRACTOR: \_\_\_\_\_ ENGINEER: \_\_\_\_\_

\_\_\_\_\_  
\_\_\_\_\_  
\_\_\_\_\_

You are directed to make the following changes in the Contract Documents.

Description:                   1.  
   2.  
   3.  
   4.  
   5.  
   6.

Reason for Change Order:   1.  
   2.  
   3.  
   4.  
   5.  
   6.

Attachments:

CHANGE IN CONTRACT PRICE:	CHANGE IN CONTRACT TIME:
Original Contract Price \$ 0.00	Original Contract Time for Substantial Completion: 0 calendar days or dates
Net Changes from previous Change Order \$ 0.00	Net Change from previous Change Orders 0 calendar days
Contract Price prior to this Change Order \$ 0.00	Contract Time prior to this Change Order Substantial Completion: 0 calendar days or dates
Net Increase(decrease) of this Change Order \$ 0.00	Net Increase(decrease) of this Change Order 0 calendar days
Contract Price with all approved Change Orders \$ 0.00	Contract Time with all approved Change Orders Substantial Completion: 0 calendar days or dates
Net % increase(decrease) from original contract price. #DIV/O! %	

**RECOMMENDED:**  
By: \_\_\_\_\_  
Engineer (Authorized Signature)

**APPROVED:**  
By: \_\_\_\_\_  
Owner (Authorized Signature)

**ACCEPTED:**  
By: \_\_\_\_\_  
Contractor (Authorized Signature)

Date: \_\_\_\_\_

Date: \_\_\_\_\_

Date: \_\_\_\_\_

**Exhibit E-B**

**APPLICATION FOR PAYMENT NO.**

To: \_\_\_\_\_ (OWNER)  
 From: \_\_\_\_\_ (CONTRACTOR)  
 Contract: \_\_\_\_\_  
 Project: \_\_\_\_\_  
 Owner's Contract No. \_\_\_\_\_ Engineer's Project No. \_\_\_\_\_  
 For Work accomplished through the date of: \_\_\_\_\_

- |  |       |
|--|-------|
| 1. Original Contract Price:                                      | _____ |
| 2. Net change by Change Order and Written Agreements(+or-):      | _____ |
| 3. Current Contract Price (1 plus 2):                            | _____ |
| 4. Total completed and stored to date:                           | _____ |
| 5. Retainage (per Agreement):                                    | _____ |
| 10% of completed Work:   | _____ |
| of stored material   | _____ |
| Total Retainage:   | _____ |
| 6. Total completed and stored to date less retainage (4 minus 5) | _____ |
| 7. Less previous Application for Payments:                       | _____ |
| 8. AMOUNT DUE THIS APPLICATION (6 MINUS 7)                       | _____ |

Accompanying Documentation:

**CONTRACTOR'S Certification:**

The undersigned CONTRACTOR certifies that (1) all previous progress payments received from OWNER on account of Work done under the Contract referred to above have been applied on account to discharge CONTRACTOR'S legitimate obligations incurred in connection with Work covered by prior Applications for Payment numbered 1 through   2   inclusive; (2) title of all Work, materials and equipment incorporated in said Work or otherwise listed in or covered by this Application for Payment will pass to OWNER at time of payment free and clear of all Liens, security interests and encumbrances (except such as are covered by a Bond acceptable to OWNER indemnifying OWNER against any such Lien, security interest or encumbrance); and (3) all Work covered by this Application for Payments is in accordance with the Contract Documents and not defective.

Date \_\_\_\_\_

State of \_\_\_\_\_  
 County of \_\_\_\_\_  
 Subscribed and sworn to before me this \_\_\_\_\_  
 day of \_\_\_\_\_

\_\_\_\_\_  
 CONTRACTOR

By: \_\_\_\_\_

\_\_\_\_\_  
 Notary Public  
 My Commission expires: \_\_\_\_\_

Payment of the above AMOUNT DUE THIS APPLICATION is recommended.

Date \_\_\_\_\_

\_\_\_\_\_  
 ENGINEER

By: \_\_\_\_\_

**Estimate Quantity Update Worksheet**

Date: \_\_\_\_\_ Date Began: ?  
 Contractor: \_\_\_\_\_ Contract Time: 120  
 Control: \_\_\_\_\_ Work Done this Mo.: #DIV/0!  
 Project No.: \_\_\_\_\_ % Complete: 75.00%  
 County: \_\_\_\_\_  
 Est. No.: 1  
 Work Type: Paving & Drainage  
 Limits: \_\_\_\_\_  
 From: \_\_\_\_\_  
 To: \_\_\_\_\_

ITEM NO.	DESCRIPTION	UNIT	PROJECT QTY	Unit Price	Project Amount	FIRST MONTH			SECOND MONTH			THIRD MONTH		
						MONTHLY QUANTITY	QTY to Date	Item Cost (Monthly)	MONTHLY QUANTITY	QTY to Date	Item Cost (Monthly)	MONTHLY QUANTITY	QTY to Date	Item Cost (Monthly)
(901) ADMINISTRATIVE														
(902) PRELIMINARY ENGINEERING														
(903) CONSTRUCTION ENGINEERING														
(904) RIGHT-OF-WAY														
(905) ROADWAY CONSTRUCTION														
100	PREP ROW	Sta.	1.100	\$1,800.00	\$1,980.00	1.000	1.000	\$0.00	0	0	\$0.00	0	0	0.00
110	BACKFILL (TY A)	Sta.	1.000	\$600.00	\$600.00	0.000	0	\$0.00	0	0	\$0.00	0	0	0.00
247	FLEX BASE (RDWY DEL)(TY D GR 6 CL 4)	CY	76.000	\$28.00	\$2,128.00	0.000	0	\$0.00	0	0	\$0.00	0	0	0.00
260	LIME (TY A SLURRY) OR (TY B)	TON	1036.000	\$2.00	\$2,072.00	0.000	0	\$0.00	0	0	\$0.00	0	0	0.00
260	LIME TREAT SUBGR (DC)(12)	SY	0.000	\$6,000.00	\$0.00	0.000	0	\$0.00	0	0	\$0.00	0	0	0.00
262	LIME (TY A SLURRY) OR (TY B)	TON	7.800	\$3,000.00	\$23,400.00	0.000	0	\$0.00	0	0	\$0.00	0	0	0.00
262	LIME TRT FOR BS CRS (NEWEXT BS)(DC)(6")	SY	1277.800	\$6.00	\$7,666.80	0.000	0	\$0.00	0	0	\$0.00	0	0	0.00
310	ASPH MATL (MC-30)	GAL	246.7	\$6.00	\$1,480.20	0.000	0	\$0.00	0	0	\$0.00	0	0	0.00
500	MOBILIZATION	LS	1.000	\$3,000.00	\$3,000.00	0.000	0	\$0.00	0	0	\$0.00	0	0	0.00
502	BARRICADES, SIGNS, AND TRAF HANDLE	MO	1.000	\$1,000.00	\$1,000.00	0.000	0	\$0.00	0	0	\$0.00	0	0	0.00
529	CONC CURB AND GUTTER (TY A)(BARRIER)	LF	600.000	\$7.50	\$4,500.00	0.000	0	\$0.00	0	0	\$0.00	0	0	0.00
644	SMALL RDS D SGN ASSM (TY A)	EA	2.000	\$300.00	\$600.00	0.000	0	\$0.00	0	0	\$0.00	0	0	0.00
644	SMALL RDS D SGN ASSM (TY F)	EA	2.000	\$500.00	\$1,000.00	0.000	0	\$0.00	0	0	\$0.00	0	0	0.00
658	DEL ASM TY A (D-SY)	EA	4.000	\$100.00	\$400.00	0.000	0	\$0.00	0	0	\$0.00	0	0	0.00
666	REFL PAV MKR TY I (Y)(SLD)(4")	LF	400.000	\$0.25	\$100.00	0.000	0	\$0.00	0	0	\$0.00	0	0	0.00
666	REFL PAV MKR TY I (Y)(BRK)(4")	LF	140.000	\$0.25	\$35.00	0.000	0	\$0.00	0	0	\$0.00	0	0	0.00
672	RAIS PAV MKR CL B (REFL)(TY II-A-A)	EA	24.000	\$3.50	\$84.00	0.000	0	\$0.00	0	0	\$0.00	0	0	0.00
3146	HOT MIX (TY D)	TON	105.5	\$34.00	\$3,587.00	0.000	0	\$0.00	0	0	\$0.00	0	0	0.00
5249	TEMP SEDMT CONT FENCE	LF	70.000	\$3.00	\$210.00	0.000	0	\$0.00	0	0	\$0.00	0	0	0.00
(906) DRAINAGE														
464	RC PIPE (CL III)(18")	LF	404.000	\$25.00	\$10,100.00	0.000	0	\$0.00	0	0	\$0.00	0	0	0.00
464	RC PIPE (CL III)(24")	LF	120.000	\$30.00	\$3,600.00	0.000	0	\$0.00	0	0	\$0.00	0	0	0.00
465	INLET (COMPL)(TY A)	EA	2.000	\$2,000.00	\$4,000.00	0.000	0	\$0.00	0	0	\$0.00	0	0	0.00
465	INLET (COMPL)(TY C)	EA	2.000	\$1,500.00	\$3,000.00	0.000	0	\$0.00	0	0	\$0.00	0	0	0.00
465	MANH (COMPL)(TYM)	EA	1.000	\$2,000.00	\$2,000.00	0.000	0	\$0.00	0	0	\$0.00	0	0	0.00
465	INLET EXT.	EA	2.000	\$700.00	\$1,400.00	0.000	0	\$0.00	0	0	\$0.00	0	0	0.00
467	SET (TY II)(18")(RCP)(1:6)	EA	4.000	\$550.00	\$2,200.00	0.000	0	\$0.00	0	0	\$0.00	0	0	0.00
467	SET (TY II)(24")(RCP)(1:6)	EA	1.000	\$650.00	\$650.00	0.000	0	\$0.00	0	0	\$0.00	0	0	0.00

Monthly Totals:	\$0.00	\$0.00	\$0.00
ADMINISTRATIVE (901)			
PRELIMINARY ENGINEERING (902)			
CONSTRUCTION ENGINEERING (903)			
RIGHT-OF-WAY (904)			
Roadway (905):	\$0.00	\$0.00	0.00
Drainage (906):	\$0.00	\$0.00	0.00

Total to Date  
 Roadway (905): \$0.00  
 Drainage (906): \$0.00  
 Total \$0.00

Prepared and Checked By: \_\_\_\_\_ Signature: \_\_\_\_\_  
 Date: \_\_\_\_\_ Printed Name: \_\_\_\_\_







Test Report Table

Material	Test	Description	Required	Remarks	Contractor Name			
					CSJ#	CSJ#	CSJ#	CSJ#
Subgrade	Tex-101-E Part III	Pulverization						
	Tex-113	Moist. Density Curve						
	Tex-115-E	In-place Density						
		Thickness						
		Proof Roll						
	Flex Base	Tex-101-E	Preparing Soils and Flex Bases					
		Tex-104-E	Determining Liquid Limit of Soils					
		Tex-105-E	Determining Plastic Limit of Soils					
		Tex-106-E	Calculating the Plasticity Index					
		Tex-107-E	Linear Shrinkage					
	Tex-110-E	Particle Size Analysis						
	Tex-113-E	Moisture Density Relationship of Base Materials(includes Limed)						
	Tex-116-E	Wet Ball Mill Method Tex						
	Tex-117-E	Triaxial Compression for Base Material (includes Limed)						
	Tex-115-E	In-place Density						
		Thickness						
En-1	IAW ASTM 4609							
	Tex-103-E							
	Tex-114-E							
	TexDOT 121 E							
	ASTM D 4546							
	ASTM D 1587							
	Tex115-E							
Hot Mix	Tex-207-F	Determining Density of Compacted Bituminous Mixtures						
	Tex-208-F	Test for Stabilometer Value of Bituminous Mixtures						
	Tex-210-F	Determining Asphalt Content of Bituminous Mixtures by Extraction						
	Tex-228-F	Determining Asphalt Content of Bituminous Mixtures by the Nuclear Method						
	Tex-229-F	Combined HMAC Cold Belt Sampling and Testing Procedure						
	Tex-236-F	Determining Asphalt Content from Asphalt Paving Mixtures By the Ignition Method						
	Tex-207-E							
		Determining Density of Compacted Bituminous Mixtures						
	Tex-212-E	Determining Moisture Content of Bituminous Mixtures						
	Tex-213-E	Determining Hydrocarbon-Volatile Content of Bituminous Mixtures						
In-Place Density	Texas SDHPT							
	Bullentin C-14							
	ASTM D-2950.76							
Lime	AASHTO T-166							
	Tex-600-J	Lime Testing Procedure						Waive testing if less than 50 Tons from a Pre-Approved Source
Rcp		Three Edge Bearing Test						1 pipe for each 100 pipe



**PARTIAL/FINAL WAIVER OF LEIN**

THE STATE OF TEXAS

COUNTY OF \_\_\_\_\_

The undersigned contracted with \_\_\_\_\_  
\_\_\_\_\_ to furnish \_\_\_\_\_  
in connection with certain improvements to real property located in \_\_\_\_\_  
County, Texas, and owned by \_\_\_\_\_  
Which improvements are described as follows:

\_\_\_\_\_  
\_\_\_\_\_  
\_\_\_\_\_

In consideration of Pay Estimate No \_\_\_\_\_ in the amount of \_\_\_\_\_  
\_\_\_\_\_ DOLLAR(\$ \_\_\_\_\_) and other good and  
valuable consideration, the receipt and sufficiency of which is hereby acknowledged and  
confessed, the undersigned does hereby waive and release any mechanic's lien or materialmen's  
lien or claims of lien that the undersigned has or hereafter has on the above mentioned real  
property on account of any labor performed or materials furnished or to be furnished or labor  
performed and materials furnished by the undersigned pursuant to the above-mentioned contract  
or any constitutional lien that the undersigned may have.

Undersigned hereby guarantees that all bids for labor performed and/or materials furnished in the  
erection and construction of such improvements on the Property have been fully paid and  
satisfied and Undersigned does further guarantee that if for any reason a lien or liens are filed for  
material or labor against said Property arising out of any bills for material or labor in connection  
with the erection or construction of said improvements thereon, Undersigned will obtain a  
settlement of such lien or liens and a proper release thereof shall be obtained.

\_\_\_\_\_  
CONTRACTOR

BY: \_\_\_\_\_  
TITLE

SWORN TO AND SUBSCRIBED BEFORE ME, on this the \_\_\_\_\_ day of \_\_\_\_\_, 20\_\_ to  
certify which witness my hand and seal of office.

\_\_\_\_\_  
NOTARY PUBLIC in and for the State of Texas

My Commission Expires: \_\_\_\_\_

**CONTRACTOR'S AFFIDAVIT OF  
PAYMENTS OF DEBTS AND CLAIMS**

<b>PROJECT:</b> <b>OWNER:</b> <b>CONTRACTOR:</b> <b>ENGINEER:</b>	<b>PROJECT NO.</b>
--	--------------------

The Contactor in accordance with the Contract Documents, hereby certifies that, except as listed below, all obligations for all materials and equipment furnished, for all work labor, and services performed, and for all known indebtedness and claims against the Contractor for damages arising in any manner in connection with the performance of the Contract referenced above for which the Owner or his property might in any way be held responsible have been paid in full or have otherwise been satisfied in full.

**EXCEPTIONS:** (If none, write "NONE". The Contractor shall furnish a bond acceptable to the Owner for each exception.)

**CONTRACTOR**

By

Title

Subscribed and sworn to before me this \_\_\_\_\_ day of \_\_\_\_\_

Notary Public:

My Commission Expires:

**Prevailing Wage Rates  
Certification Statement**

Date \_\_\_\_\_

Project Name \_\_\_\_\_

CSJ# \_\_\_\_\_

Contractor \_\_\_\_\_

Application# \_\_\_\_\_

I, \_\_\_\_\_ do hereby state:  
(Name of Project Director)

1. That a payroll (form WH-347 or similar form) was submitted for contract work Performed for the period covered by the attached application.
2. That a statement of compliance(form WH-347 or similar form) was submitted with the payroll.
3. The certified payroll complies with the classifications and minimum wage rates Stipulated in the contract.
4. That a minimum of one interview was conducted with laborers using Form HUD-11 or similar.

\_\_\_\_\_  
Signature

**U.S. Department of Labor**  
 Employment Standards Administration  
 Wage and Hour Division

**PAYROLL**

(For Contractor's Optional Use; See Instructions, Form WH-347 Inst.)



Persons are not required to respond to the collection of information unless it displays a currently valid OMB control number.

NAME OF CONTRACTOR  OR SUBCONTRACTOR

ADDRESS

OMB No.: 1215-0149  
 Expires: 03/31/2006

PAYROLL NO.

FOR WEEK ENDING

PROJECT AND LOCATION

PROJECT OR CONTRACT NO.

(1) NAME, ADDRESS, AND SOCIAL SECURITY NUMBER OF EMPLOYEE	(2) NO. OF WITHHOLDING EXEMPTIONS	(3) WORK CLASSIFICATION	OT OR ST.	(4) DAY AND DATE							(5) TOTAL HOURS	(6) RATE OF PAY	(7) GROSS AMOUNT EARNED	(8) DEDUCTIONS				(9) NET WAGES PAID FOR WEEK	
				HOURS WORKED EACH DAY										FICA	WITH- HOLDING TAX	OTHER	TOTAL DEDUCTIONS		
			D																
			S																
			D																
			S																
			D																
			S																
			D																
			S																
			D																
			S																
			D																
			S																

We estimate that it will take an average of 56 minutes to complete this collection of information, including time for reviewing instructions searching existing data sources, gathering and maintaining the data needed, and completing and reviewing the collection of information. If you have any comments regarding these estimates or any other aspect of this collection of information, including suggestions for reducing this burden, send them to the Administrator, Wage and Hour Division, ESA, U. S. Department of Labor, Room S3502, 200 Constitution Avenue, N. W., Washington, D. C. 20210.

FORM WH-347, Revised Nov. 1988 - FORMERLY SOL 184 - PURCHASE THIS FORM DIRECTLY FROM THE SUPT. OF DOCUMENTS

**Exhibit E-K**



**CERTIFICATE OF CONSTRUCTION COMPETITION**

THIS IS TO CERTIFY THAT ON \_\_\_\_\_ DAY OF \_\_\_\_\_ A FINAL INSPECTION was made of the project herein described.

CONTRACT

CONTRACT DATE: \_\_\_\_\_  
OWNER: \_\_\_\_\_  
CONSTRUCTION CONTRACTOR: \_\_\_\_\_  
OF THE CITY OF \_\_\_\_\_ STATE OF \_\_\_\_\_

PROJECT DESCRIPTION

CONSTRUCTION OF \_\_\_\_\_

CONTRACT NO: \_\_\_\_\_  
Located in or near the City/Precinct Of \_\_\_\_\_

THIS IS TO CERTIFY”

1. That the work has been completed in accordance with the plans and specifications and all addenda, change orders, supplemental agreements thereto, and with the following exceptions:  
\_\_\_\_\_

- 2. That the sum of \_\_\_\_\_, deducted from the final payment of the Contractor is a fair and equitable settlement for the foregoing except work.
- 3. That the contractor has presented a “Certificate of Release” starting under oath, that all claims arising out of the performance of work have been fulfilled, and the Owner is released from all claims arising under or by virtue of said contract.
- 4. That the CONTRACTOR has presented in behalf of itself and its sureties, satisfactory evidence that it is bound to repair, replace, and make good any faulty workmanship and/or materials discovered in the work within a period of one year from this date, as provided in said contract.

5. Amount of Original Contract	_____
Present Amount of Contract	_____
Total Amount of earned to Date	_____
Less: previous payments	_____
Balance	_____
Authorized deductions	_____
AMOUNTY OF FINAL PAYMENT	_____

6. That the final payment in the amount of \_\_\_\_\_  
\_\_\_\_\_ is now due and payable.

\_\_\_\_\_  
Engineer's Signature

**CONCURRED BY:**

\_\_\_\_\_  
Contractor's Name

By: \_\_\_\_\_

Title: \_\_\_\_\_

**CONCURRED BY:**

\_\_\_\_\_  
City/Precinct

By: \_\_\_\_\_

Title: \_\_\_\_\_

**CONTRACTOR'S AFFIDAVIT OF RELEASE OF LIENS**

<b>PROJECT:</b> <b>OWNER:</b> <b>CONTRACTOR:</b> <b>ENGINEER:</b>	<b>PROJECT NO.</b>
--	--------------------

The Contractor, in accordance with the Contract Documents, and in consideration for the full and final payment to the Contractor for all services in connection with the project, does hereby waive and release any and all liens, or any and all claims to liens which the Contractor may have on or affecting the project as a result of its contract(s) for the Project or for performing labor and/or furnishing materials in any way connected with the construction of any aspect of the project. The Contractor further certifies and warrants that all subcontractors of labor and/or materials for the Project, except as listed below, have been paid in full for all labor and/or materials supplied to, for through or at the direct or indirect request of the Contractor prior to, through and including the date of this affidavit.

**EXCEPTIONS:** (If none, write "NONE". The Contractor shall furnish a bond acceptable to the Owner for each exception.)

**CONTRACTOR**

By \_\_\_\_\_

Title \_\_\_\_\_

Subscribed and sworn to before me this \_\_\_\_\_ day of \_\_\_\_\_

Notary Public: \_\_\_\_\_

My Commission Expires: \_\_\_\_\_





Contractor Name \_\_\_\_\_  
 Starting Date \_\_\_\_\_  
 Project Ending Date \_\_\_\_\_  
 Engineers / County Project Description \_\_\_\_\_

Application No. \_\_\_\_\_  
 Application Date \_\_\_\_\_  
 Period To \_\_\_\_\_  
 Engineers / County Project No. \_\_\_\_\_

No.	Item Code	Description	Unit	Original Rates	Original Schedule Value		Revised Rates	Value		First Month		Second Month		Third Month		Balance To Finish		
					Quan	Dollars		Quan	Dollars	Monthly Quan	Item Cost (Monthly)	QTY to Date	Item Cost (Monthly)	Monthly Quan	QTY to Date	Item Cost (Monthly)	QTY to Date	Monthly Quan
<b>(905) ROADWAY</b>																		
1	100	Preparation of Right-of-Way	Sq	\$ -	0.0	-	\$ -	0.0	-	0	0	-	-	-	-	-	0.0	0.0
2	152	6" road Grader Work(Dens Cont.) Subgrade	S.Y.	\$ -	0.0	-	\$ -	0.0	-	0	0	-	-	-	-	-	0.0	0.0
3	247	6" FL BS(Compl in Plac)	S.Y.	\$ -	0.0	-	\$ -	0.0	-	0	0	-	-	-	-	-	0.0	0.0
4	310	Asph. Matl. (MC-30)	Gall	\$ -	0.0	-	\$ -	0.0	-	0	0	-	-	-	-	-	0.0	0.0
5	340	Asph. Conc. Ty D	S.Y.	\$ -	0.0	-	\$ -	0.0	-	0	0	-	-	-	-	-	0.0	0.0
6	500	Mobilization	L.S.	\$ -	0.0	-	\$ -	0.0	-	0	0	-	-	-	-	-	0.0	0.0
7	502	Barricades, Signs and Traffic Handling	Mo	\$ -	0.0	-	\$ -	0.0	-	0	0	-	-	-	-	-	0.0	0.0
8	530	Turnouts	Ea	\$ -	0.0	-	\$ -	0.0	-	0	0	-	-	-	-	-	0.0	0.0
9	5249	Tem Sedmt Cont Fence (Installed)	L.F.	\$ -	0.0	-	\$ -	0.0	-	0	0	-	-	-	-	-	0.0	0.0
10	5249	Tem Sedmt Cont Fence Handling (Removed)	L.F.	\$ -	0.0	-	\$ -	0.0	-	0	0	-	-	-	-	-	0.0	0.0
<b>Total Roadway</b>																		
<b>(906) DRAINAGE</b>																		
11	530	Drwys (Asph Conc Pav) (PRB)	S.Y.	\$ -	0.0	-	\$ -	0.0	-	0	0	-	-	-	-	-	0.0	0.0
12	247	Drwys Flexible Base	S.Y.	\$ -	0.0	-	\$ -	0.0	-	0	0	-	-	-	-	-	0.0	0.0
13	556	8" Storm Drain	L.F.	\$ -	0.0	-	\$ -	0.0	-	0	0	-	-	-	-	-	0.0	0.0
14	556	18" RCP Storm Drain	L.F.	\$ -	0.0	-	\$ -	0.0	-	0	0	-	-	-	-	-	0.0	0.0
15	465	Ty "A" Inlets	Ea.	\$ -	0.0	-	\$ -	0.0	-	0	0	-	-	-	-	-	0.0	0.0
16	465	Concrete Manhole	Ea.	\$ -	0.0	-	\$ -	0.0	-	0	0	-	-	-	-	-	0.0	0.0
17	15"	R.C.P.	L.F.	\$ -	0.0	-	\$ -	0.0	-	0	0	-	-	-	-	-	0.0	0.0
18	15"	Ty "A" Inlets	Ea.	\$ -	0.0	-	\$ -	0.0	-	0	0	-	-	-	-	-	0.0	0.0
19		Manhole	Ea.	\$ -	0.0	-	\$ -	0.0	-	0	0	-	-	-	-	-	0.0	0.0
20		6.0" Valley Gutter	L.F.	\$ -	0.0	-	\$ -	0.0	-	0	0	-	-	-	-	-	0.0	0.0
<b>Total Drainage</b>																		
<b>TOTAL BASE AMOUNTS:</b>																		
0.0																		

Print Name \_\_\_\_\_ Date \_\_\_\_\_

Signature \_\_\_\_\_

## **CONSTRUCTION IDENTIFICATION SIGN:**

Size, 4' – 0" X 8' – 0"

Letters to be brown with beige background

Construction Identification Signs To Be Erected Prior To Beginning of Actual Construction

Wood for Signs Shall Be  $\frac{3}{4}$ " Waterproofing Resin Bonded Exterior Grade Plywood (Douglas Fir Plywood Association of Equal)

Payment for Furnishing, Erecting, Maintenance and Removing Construction Identification Signs Will Not Be made Directly. Such Costs Shall be Included in the Overall Bid Submitted.

To Be Erected as Indicated on title Sheet.

Precinct Logo



# Your Tax Dollars at Work Hidalgo County Pct 3

Joe M. Flores, Commissioner  
Border Colonia Access Program

In Partnership with Texas Department of Transportation

## Randolph Barnett Subdivision No. 1

Hidalgo County Commissioner's Court

- Ramon Garcia - County Judge
- Joel Quintanilla - Commissioner Pct #1
- Hector "Tito" Palacios - Commissioner Pct #2
- Joe M. Flores - Commissioner Pct #3
- Joseph Palacios - Commissioner Pct #4

Project Contractor:

Project Engineer: Javier Hinojosa Engineering

# HIDALGO COUNTY PRECINCT NO. 3

## CONSTRUCTION PLANS FOR BORDER COLONIA ACCESS PROGRAM ROUND III – COMPETITIVE RANDOLPH BARNETT SUBDIVISION No. 1 CSJ: 3C1080600

CONSTRUCTION OF LOCAL STREETS CONSISTING OF:  
GRADING, STRUCTURES, FLEXIBLE BASE  
AND ASPHALTIC CONCRETE PAVEMENT

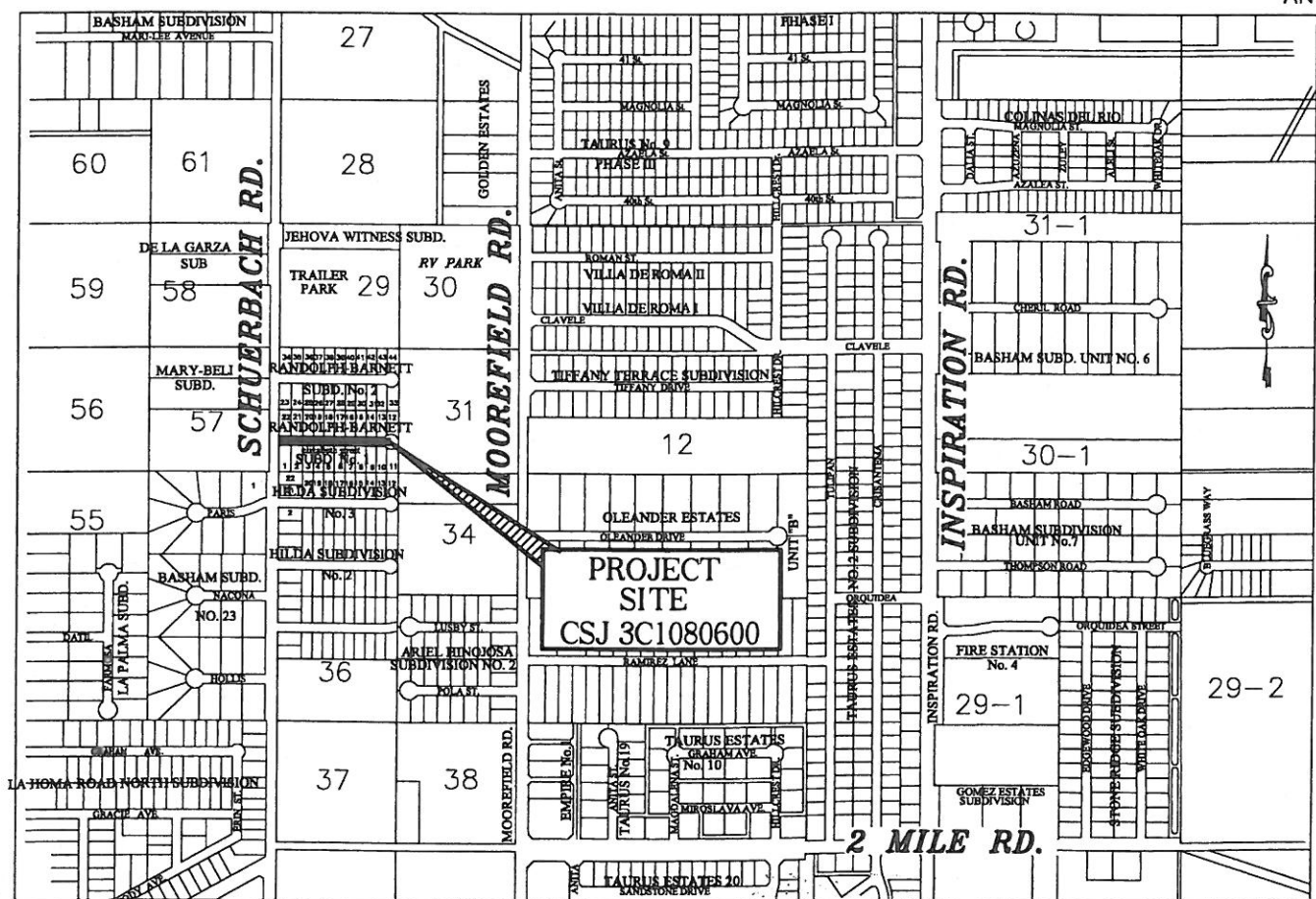

LOCATION MAP

RANDOLPH BARNETT SUBDIVISION No. 1		AREA OF DISTURBED SOIL (AC)	
CSJ: 3C1080600	ELIZABETH STREET	650 FT	0.12 MILES
		0.746 ACRES	

### HIDALGO COUNTY COMMISSIONERS

- |                                  |                   |
|----------------------------------|-------------------|
| RAMON GARCIA . . . . .           | COUNTY JUDGE      |
| JOEL QUINTANILLA . . . . .       | COMMR. PCT. No. 1 |
| HECTOR "TITO" PALACIOS . . . . . | COMMR. PCT. No. 2 |
| JOE M. FLORES . . . . .          | COMMR. PCT. No. 3 |
| JOSEPH PALACIOS . . . . .        | COMMR. PCT. No. 4 |

APPROVAL  
HIDALGO COUNTY  
COLONIA ACCESS PROGRAM  
*[Signature]*  
AGUSTO VARGAS JR, DIRECTOR  
DATE: 08/29/2012

APPROVAL  
HIDALGO COUNTY PRECINCT No.3  
*[Signature]*  
JOE M. FLORES, COMMISSIONER  
DATE: 09/28/12

APPROVAL  
HIDALGO COUNTY PLANNING DEPT.  
*[Signature]*  
RAUL SESIN P.E., PLANNING ADMINISTRATOR  
DATE: 09/26/12

CONCURRENCE  
HIDALGO COUNTY DRAINAGE  
DIST. No. 1  
*[Signature]*  
GODFREY GARZA JR, DISTRICT MANAGER.  
DATE: 9/22/12

STANDARD SHEETS IDENTIFIED ON THE INDEX ON SHEETS  
HAVEN BEEN SELECTED BY ME OR UNDER MY RESPONSIBLE  
SUPERVISION AS BEING APPLICABLE TO THIS PROJECT.

*[Signature]*  
JAVIER HINOJOSA P.E.  
DATE: 9/21/12

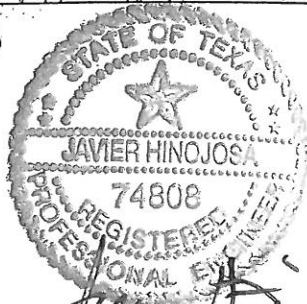

JAVIER HINOJOSA ENGINEERING  
TBE FIRM NUMBER F-1295

SPECIFICATIONS ADOPTED BY THE TEXAS DEPARTMENT  
OF TRANSPORTATION ON JUNE 1, 2004 SHALL GOVERN  
ON THE PROJECT.



HIDALGO COUNTY

**JEH**  
JAVIER HINOJOSA ENGINEERING  
CONSULTING ENGINEERS  
416 E. DOVE AVENUE McALLEN, TEXAS 78504  
PHONE (956) 668-1588

**RANDOLPH BARNETT SUBDIVISION No. 1**

**ELIZABETH STREET**

CSJ: 3C1080600  
 BEG STA. 10+11  
 END STA. 16+50  
 NET LENGTH OF PROJECT: 639 FT.=0.12 MILES



HIDALGO COUNTY



JAVIER HINOJOSA ENGINEERING  
 CONSULTING ENGINEERS  
 416 E. DOVE AVENUE McALLEN, TEXAS 78504  
 PHONE (956) 668-1588

**COLONIA ACCESS PROGRAM  
 SUBDIVISIONS LIMITS**

HIDALGO COUNTY TEXAS

DN#		FED. RD. DIV. NO.	STATE	FEDERAL AID PROJECT NO.	HIGHWAY NO.
CK DN#			TEXAS		
DN#					
CK DN#		STATE DIST. NO.	COUNTY	CONTROL NO.	SECT. NO.
TR#			HIDALGO		
CK TR#					2

SHEET NO.    DESCRIPTION

GENERAL

- 1            - TITLE SHEET
- 2            - SUBDIVISION LIMITS
- 3            - INDEX SHEET
- 4            - TYPICAL SECTION
- 5            - ESTIMATE AND QUANTITIES (RANDOLPH BARNETT SUBDIVISION No. 1)
- 6            - PROJECT LAYOUT -RANDOLPH BARNETT SUBDIVISION No. 1
- 7            - GENERAL NOTES

TRAFFIC CONTROL PLAN SHEETS

- 8            - TRAFFIC CONTROL NARRATIVE

STANDARDS

- 9            - BC(1)-99 (MDD) BARRICADE AND CONSTRUCTION STANDARDS
- 10          - WZ(VL)-03 SIGNS FOR UNEVEN LANES

ROADWAY DETAILS

- 11-12       - ELIZABETH STREET

STANDARDS

- 13          - DRIVEWAY SUMMARY TABLE
- 14          - (D) TURNOUTS DETAILS
- 15          - (D) DRIVEWAY DETAILS
- 16          - (D) DRIVEWAY & TURNOUTS PROFILE DETAILS

ENVIRONMENTAL ISSUES

- 17          - BORDER ACCESS COLONIA PROJECT  
(EROSION AND SEDIMENT CONTROLS)

STANDARDS

- 18          - [S] EC(1)-93 (REGULATORY SIGNS)

LEGEND:

- [D] DENOTES DISTRICT STANDARD
- [S] DENOTES STATE STANDARD



HIDALGO COUNTY



JAVIER HINOJOSA ENGINEERING  
CONSULTING ENGINEERS  
416 E. DOVE AVENUE McALLEN, TEXAS 78504  
PHONE (956) 868-1588

COLONIA ACCESS PROGRAM  
INDEX OF SHEET

HIDALGO COUNTY TEXAS

DN:		FED. RD. DIV. NO.	STATE	FEDERAL AID PROJECT NO.	HIGHWAY NO.
CK DN:			TEXAS		
DW:					
CK DW:		STATE DIST. NO.	COUNTY	CONTROL NO.	SECT. NO.
TR:			HIDALGO		
CK TR:					3



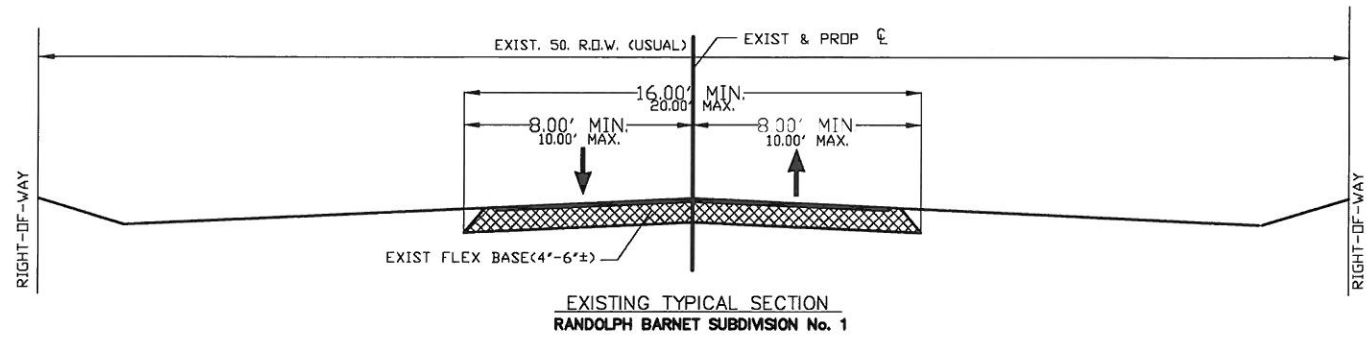

ITEM 247: FLEXIBLE BASE

FLEXIBLE BASE TYPE E WILL BE COMPOSED OF CALICHE (ARGILLACEOUS LIMESTONE, CALCAREOUS CLAY PARTICLES) AND MAY CONTAIN STONE, CONGLOMERATE, GRAVEL, SAND OR GRANULAR MATERIALS WHEN THESE MATERIALS ARE IN SITU WITH THE CALICHE

247-1

FLEXIBLE BASE (TYPE E GR 4) SHALL CONFORM TO FOLLOWING REQUIREMENTS:

RETAINES ON SQ. SIEVE	PERCENT RETAINED
2"	0
1/2"	20 - 60
No. 4	40 - 75
No. 40	70 - 90
MAX. PI:	15
MAX. WET BALL PI:	15
WET BALL MILL MAX AMOUNT:	50
MIN. COMP. STRENGTH PSI:	150 AT 15 PSI LATERAL PRESSURE
TRIAxIAL TEST	TEXT - 117-E

THE WET BALL TEST (TEX-116-E) SHALL BE RUN ON THE PLASTICITY INDEX OF THE MATERIAL PASSING THE No. 40 SIEVE SHALL BE DETERMINED (WETBALL PI).

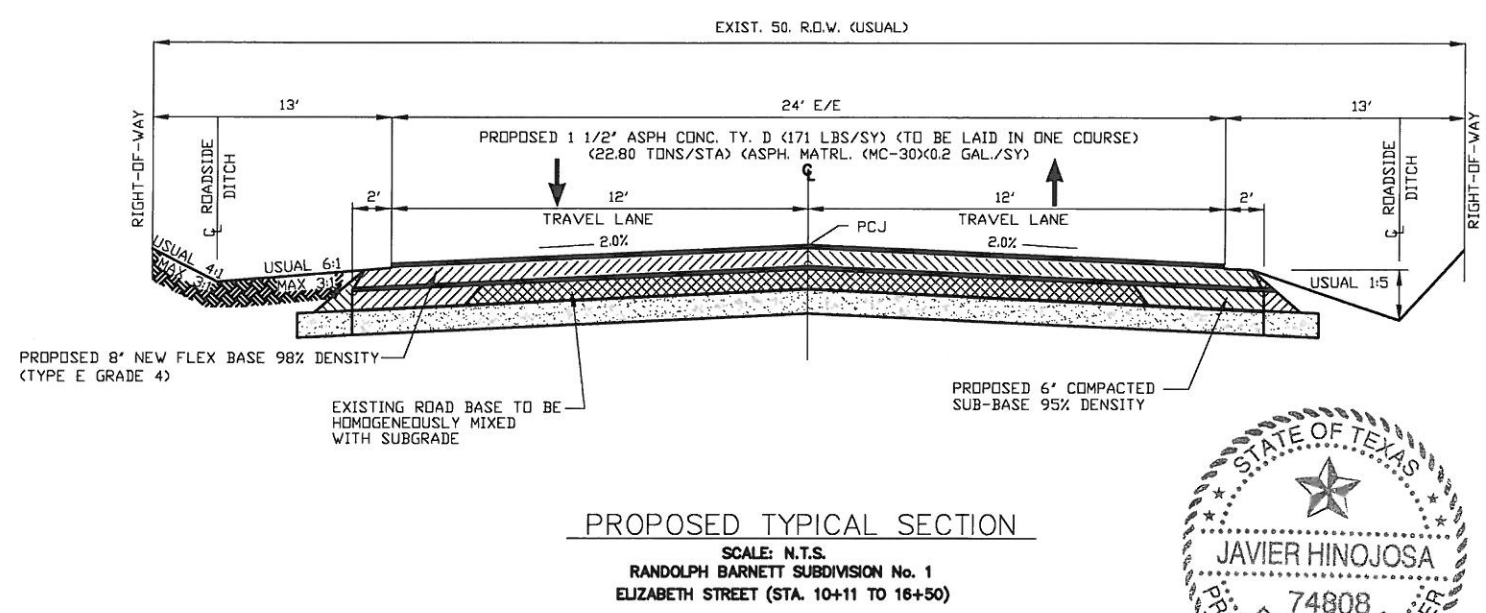

GENERAL NOTES:

- PVI - POINT OF VERTICAL INTERSECTION
- PCJ - PERMISSIBLE CONSTRUCTION JOINT
- PERMISSIBLE CONSTRUCTION JOINT SHALL FALL ON THE PROPOSED ROADWAY CENTERLINE.
- ALL GRADING SHALL BE WITHIN THE EXISTING RIGHT OF WAY LIMITS.
- WHERE REQUIRED BY FIXTURES OR UNUSUAL CONDITIONS THE GOVERNING SLOPES MAY BE VARIED WHEN SPECIFICALLY DIRECTED BY THE ENGINEER.
- THE COMPLETE BASE SHALL BE PROOF ROLLED BEFORE THE EARTH SHOULDER IS SHAPED, AND ITS FINAL COMPACTION WILL BE DONE OVER BASE AND EDGE OF SHOULDER THE EXISTING SUBGRADE OR ROADWAY SHALL BE SHAPED, BLADED, AND PROOF ROLLED A MINIMUM DISTANCE OF 2' BEYOND THE EDGE OF THE PROPOSED BASE COURSE ANY SOFT SPOT SHALL BE STABILIZED IN ACCORDANCE WITH ITEM 216.
- SEE 'SUBDIVISION LIMITS' SHEET FOR PROJECT LIMITS.



HIDALGO COUNTY



JAVIER HINOJOSA ENGINEERING  
CONSULTING ENGINEERS  
416 E. DOVE AVENUE McALLEN, TEXAS 78504  
PHONE (956) 668-1588

COLONIA ACCESS PROGRAM  
TYPICAL SECTION

HIDALGO COUNTY TEXAS

DN:		FED. RD. DIV. NO.	STATE	FEDERAL AID PROJECT NO.	HIGHWAY NO.
CK DN:			TEXAS		
DW:					
CK DW:		STATE DIST. NO.	COUNTY	CONTROL NO.	SECT. NO.
TR:			HIDALGO		
CK TR:					4

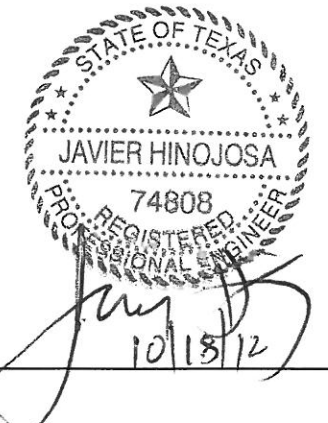

RANDOLPH BARNETT SUBDIVISION No. 1 ELIZABETH STREET					PROJECT QUANTITIES					TOTAL	
CSJ: 3C1080600					ITEM.	CODE	UNIT	DESCRIPTION	EST.	FIN.	
6.39					100	502	STA	PREPARING R.O.W.	6.39		
2160					247	699	SY	FL BS (COMPL IN PLACE) (TY E GR 4)	2160		
2160					251	---	SY	REWRKING BS MATL (DC) (TY D 6")	2160		
1858					340	---	SY	ASPH CONC (TY D)	1858		
432					310	501	GAL	ASPH MATRL (MC-30)	432		
2					502	501	MO	BARRICADES, SIGNS AND TRAFFIC HANDLING	2		
454					530	540	SY	DRIVEWAY (ASPH-CONC-PAV) (PB-1)	454		
153					530	542	SY	DRIVEWAY (CONCRETE 3000 PSI)	153		
30					530	655	SY	TURNOUTS (ASPH-CONC-PAV)(PBS-2)	30		
300					506	---	LF	TEMP SEDMT CONT FENCE	300		
300					506	---	LF	TEMP SEDMT CONT FENCE REMOVE	300		
600					473	---	LF	15" ADS CULVERT PIPE	600		
70					467		LF	18" RCP CULVERT PIPE	70		
2					467		Ea	SAFETY END TREATMENTS	2		



HIDALGO COUNTY



JAVIER HINOJOSA ENGINEERING  
CONSULTING ENGINEERS  
416 E. DOVE AVENUE McALLEN, TEXAS 78504  
PHONE (956) 668-1588

ESTIMATE & QUANTITIES

HIDALGO COUNTY TEXAS

DN:		FED. RD. DIV. NO.	STATE	FEDERAL AID PROJECT NO.	HIGHWAY NO.
CK DN:			TEXAS		
DN:					
CK DN:		STATE DIST. NO.	COUNTY	CONTROL. NO.	SECT. NO.
TR:			HIDALGO		
CK TR:					5



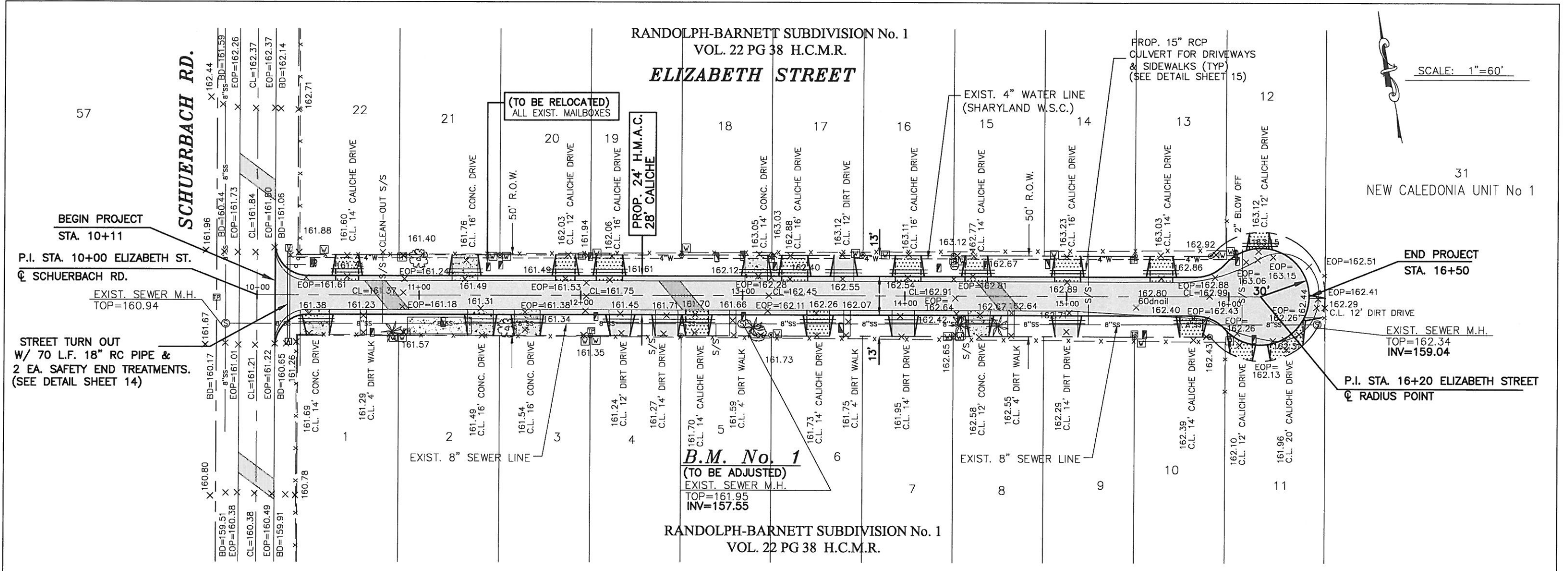

SCALE: 1"=60'

BEGIN PROJECT  
STA. 10+11

END PROJECT  
STA. 16+50

P.I. STA. 10+00 ELIZABETH ST.  
SCHUERBACH RD.

P.I. STA. 16+20 ELIZABETH STREET  
RADIUS POINT

STREET TURN OUT  
W/ 70 L.F. 18" RC PIPE &  
2 EA. SAFETY END TREATMENTS.  
(SEE DETAIL SHEET 14)

EXIST. SEWER M.H.  
TOP=162.34  
INV=159.04

**B.M. No. 1**  
(TO BE ADJUSTED)  
EXIST. SEWER M.H.  
TOP=161.95  
INV=157.55

LEGEND

- F.F.= EXIST. FINISH FLOOR
- x 182.68 EXIST. NATURAL GROUND
- x EOP=183.09 EXIST. EDGE OF PAVEMENT
- x CL=183.89 EXIST. CENTER LINE
- [Symbol] EXIST. MAIL BOX
- [Symbol] EXIST. BRICK MAIL BOX
- [Symbol] EXIST. WATER METER
- x- EXIST. FENCE
- [Symbol] EXIST. PINE TREE
- [Symbol] EXIST. PALO BLANCO TREE
- [Symbol] EXIST. OAK TREE
- [Symbol] EXIST. PALM TREE
- [Symbol] EXIST PAVEMENT
- [Symbol] PROPOSED PAVEMENT
- [Symbol] CONCRETE DRIVEWAY

Ⓢ B.M. No. 1  
ELEVATION=168.57  
X-MARK IN SEWER MANHOLE

DRAINAGE PATTERNS TO REMAIN THE SAME. DRAINAGE  
TO BE MAINTAINED AS PER EXISTING CONDITIONS.

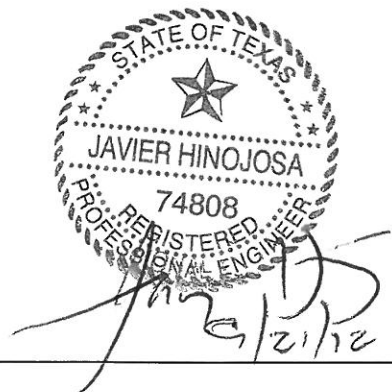

TEXAS DEPARTMENT OF TRANSPORTATION

**J E H**  
JAVIER HINOJOSA ENGINEERING  
CONSULTING ENGINEERS  
416 E. DOVE AVENUE McALLEN, TEXAS 78504  
PHONE (956) 868-1588

RANDOLPH BARNETT  
SUBDIVISION No. 1  
PROJECT LAYOUT  
HIDALGO COUNTY TEXAS

DN	STATE	FEDERAL AID PROJECT NO.	HIGHWAY NO.
CK DN	TEXAS		
DN	STATE DIST. NO.	COUNTY	CONTROL. NO.
CK DN		HIDALGO	
TR	SECT. NO.	JOB NO.	SHEET NO.
CK TR			6

GENERAL NOTES:

1. THE CONTRACTOR MAY SUBMIT AN ALTERNATIVE CONSTRUCTION SEQUENCE AND TRAFFIC CONTROL PLAN TO THE ENGINEER FOR APPROVAL. ALL WORK AND MATERIALS REQUIRED FOR TRAFFIC HANDLING SHALL NOT BE PAID FOR DIRECTLY BUT SHALL BE CONSIDERED PART OF ITEM 502, "BARRICADES, SIGNS, AND TRAFFIC HANDLING". ALL BARRICADES AND SIGNS TO REPLACE DAMAGED ONES.
2. FLASHING WARNING LIGHTS AND/OR FLAGS SHALL BE USED TO CALL ATTENTION TO THE EARLY WARNING SIGNS.
3. STEADY BURN (TY C) WARNING LIGHTS SHALL BE USED TO MARK CHANNELIZING DEVICES AT NIGHT AS NEEDED.
4. ADDITIONAL SIGNS, BARRICADES AND/OR OTHER CHANNELIZING DEVICES MAY BE REQUIRED AND/OR ADJUSTED AS DIRECTED BY THE ENGINEER.
5. SIGN AND/OR BARRICADE LOCATIONS SHALL BE IN ACCORDANCE WITH THE "TEXAS MANUAL ON UNIFORM TRAFFIC CONTROL DEVICES" AND/OR THE BC STANDARD SHEETS.
6. EXISTING CONNECTING ROADS AND PRIVATE DRIVES SHALL BE KEPT OPEN TO TRAFFIC AT ALL TIMES, EXCEPT AS OTHERWISE PROVIDED FOR OR APPROVED BY THE ENGINEER.
7. ALL SIGNING, SHALL BE THE RESPONSIBILITY OF THE CONTRACTOR AND SHALL BE IN ACCORDANCE WITH THE "T.M.U.T.C.D."
8. WHEN CONSTRUCTION OPERATIONS RESULT IN DROP OR MORE THAN 2" NEXT TO TRAVEL WAY, A 3:1 SLOPE AND 4.0' BUFFER ZONE WILL BE REQUIRED DURING NON WORKING HOURS.
9. FOR POSTED SPEED EXCEEDING 45 MPH, ADVISORY SPEED SIGNS WITH APPROPRIATE WARNING SIGNS, SHALL BE POSED IN THE VICINITY OF SPECIFIED WORK ZONES WITHIN THE PROJECT, UNLESS OTHERWISE DIRECTED BY THE ENGINEER.
10. LENGTH AND SPACING OF CHANNELIZING DEVICES SHALL BE AS SHOWN ON THE BC STANDARDS AND THE "T.M.U.T.C.D." OTHER SIGNS MAY BE USED IN ADDITION TO THOSE REQUIRED BY BARRICADE STANDARDS.
11. NON-REMOVEABLE WORK ZONE STRIPING FOR THIS PROJECT REQUIRED BY THE "T.M.U.T.C.D." SHALL CONSIST OF THERMOPLASTIC MATERIAL AND SHALL BE IN ACCORDANCE WITH THE "WORK ZONE PAVEMENT MARKINGS" STANDARD WZ(STPM)-97.
12. ALL WORK SHALL BE DONE EXPEDITIOUSLY DURING DAYLIGHT HOURS, AS DIRECTED BY THE ENGINEER. NECESSARY FLAGGERS AND APPROPRIATE SIGNING TO SAFETY GUIDE TRAFFIC THROUGH THE WORK AREA WILL BE REQUIRED A DIRECTED BY THE ENGINEER.
13. REFER TO STANDARD SHEETS BC(1)-99 THRU BC(9)-98 FOR OTHER PERTINENT INFORMATION NOT SHOWN.
14. DRIVEWAYS AND TURNOUTS ARE TO BE CONSTRUCTED AS PER TYPE AND WIDTH SHOWN ON THE DRIVEWAYS AND TURNOUTS DETAILS.
15. SIGNS WILL BE INSTALLED BY HIDALGO COUNTY PRECINCT 3.
16. MAIL BOXES TO BE REMOVED AND REPLACED BY CONTRACTOR.
17. HORIZONTAL AND VERTICAL CONTROL POINTS TO BE SUPPLIED BY THE ENGINEER PRIOR TO COMMENCING WORK.
18. IT SHALL BE THE CONTRACTOR'S RESPONSIBILITY TO LOCATE UNDERGROUND UTILITIES. WHETHER SHOWN OR NOT SHOWN ON THE DRAWINGS, SUFFICIENTLY IN ADVANCE OF OPERATIONS TO PRECLUDE DAMAGE TO SAME.
19. WATER, SEWER, OR OTHER UTILITY SERVICES SHALL NOT BE INTERRUPTED. ANY DAMAGES TO EXISTING UTILITIES WILL BE THE CONTRACTOR'S RESPONSIBILITY.
20. IN THE EVENT OF DAMAGE TO UNDERGROUND FACILITIES, WHETHER SHOWN OR NOT SHOWN IN THE DRAWINGS, THE CONTRACTOR SHALL MAKE THE NECESSARY REPAIRS TO PLACE THE FACILITIES BACK IN SERVICE AT NO INCREASMT IN THE CONTRACTOR'S PRICE AND ALL SUCH REPAIRS SHALL CONFORM TO THE REQUIREMENTS OF THE COMPANY OR AGENCY SERVICING THE FACILITY.
21. THE CONTRACTOR SHALL EXERCISE EXTRA CARE TO PREVENT DAMAGE TO ALL OTHER STRUCTURES IN THE AREA INCLUDING BUILDINGS, FENCES, ROADS, PIPELINES, UTILITIES, ETC., WHETHER PUBLICLY OR PRIVATELY OWNED.
22. UNTIL ACCEPTANCE BY THE ENGINEER OF ANY PART OR ALL OF THE CONSTRUCTION, AS PROVIDED FOR IN THE PLANS AND THESE SPECIFICATIONS, IT SHALL BE UNDER THE CHARGE AND CARE OF THE CONTRACTOR, AND HE SHALL TAKE EVERY NECESSARY PRECAUTION AGAINST INJURY OR DAMAGE TO ANY PART OF THE WORK. THE CONTRACTOR SHALL REBUILD, REPAIR, RESTORE AND MAKE GOOD, AT HIS OWN EXPENSE, ALL INJURIES OR DAMAGE TO ANY PORTION OF THE WORK BEFORE ITS COMPLETION AND ACCEPTANCE.
23. NO OPEN TRENCHES OR EXCAVATION SHALL BE LEFT OPEN OVERNIGHT.
24. EXISTING ASPHALT PAVING TO BE SCARIFIED AND REMOVED AS PART OF THE RIGHT OF WAY PREPARATION.
25. ADJUSTMENT OF ALL MANHOLE TOPS TO BE INCIDENTAL TO PRICE BID FOR RIGHT OF WAY PREPARATION.



**HIDALGO COUNTY**



**JAVIER HINOJOSA ENGINEERING  
CONSULTING ENGINEERS**  
416 E. DOVE AVENUE McALLEN, TEXAS 78504  
PHONE (956) 868-1588

**COLONIA ACCESS PROGRAM  
GENERAL NOTES**

**HIDALGO COUNTY TEXAS**

DN:		FED. RD. DIV. NO.	STATE	FEDERAL AID PROJECT NO.	HIGHWAY NO.
CK DN:			TEXAS		
DN:					
CK DN:		STATE DIST. NO.	COUNTY	CONTROL NO.	SECT. NO.
TR:			HIDALGO		
CK TR:					7

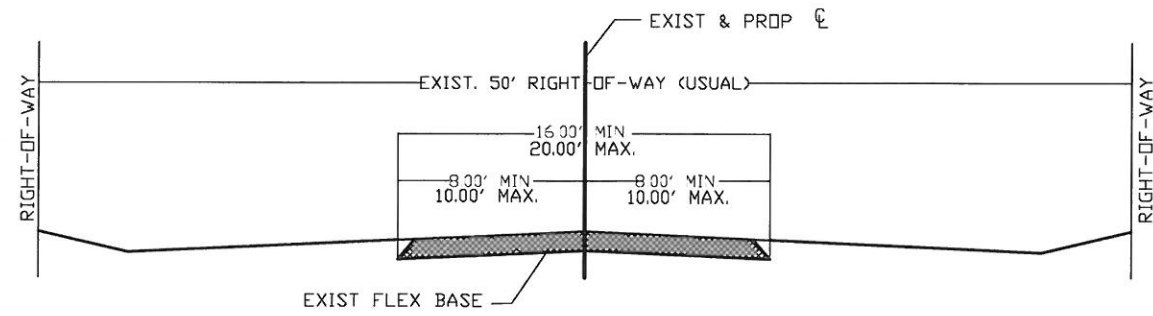

EXISTING TYPICAL STREET SECTION

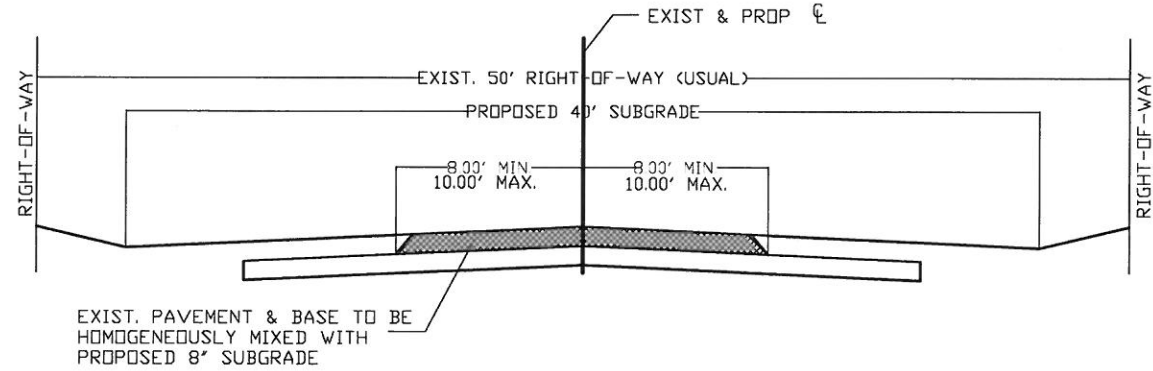

PHASE 1

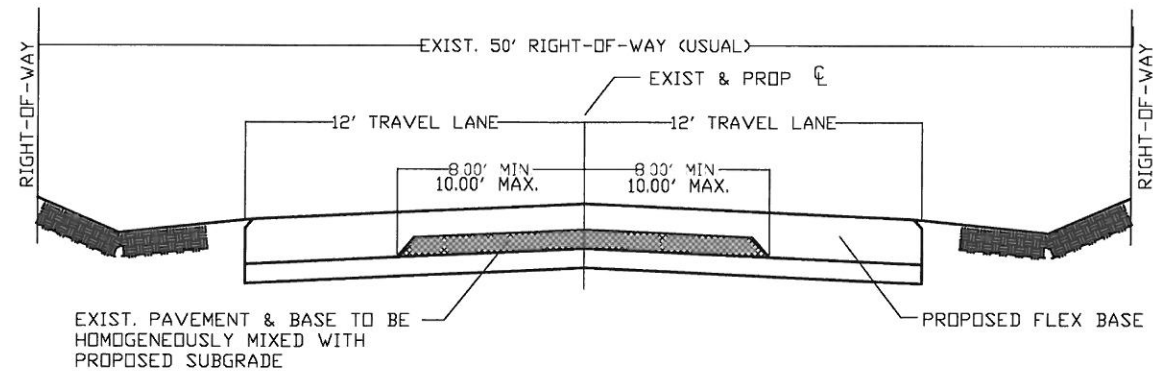

PHASE 2

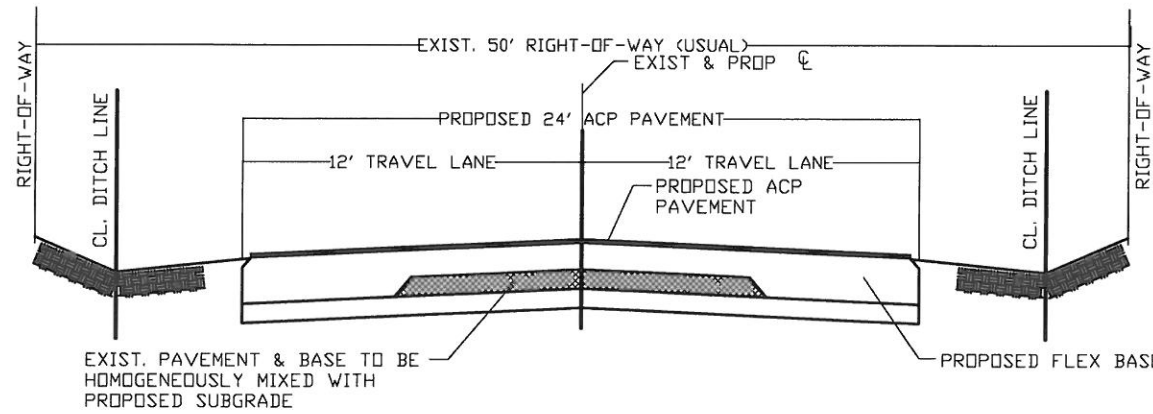

PHASE 3

SEQUENCE OF WORK

INSTALL PROJECT LIMIT SIGNS, ADVANCE WARNING SIGNS, AND CROSSROADS BARRICADE SIGNS AS SHOWN ON THE TRAFFIC CONTROL PLAN (TCP) AND OR AS DIRECTED BY THE ENGINEER. ALL SIGNS SHALL BE IN ACCORDANCE WITH THE MUTCD, AND SHALL BE IN PLACE PRIOR TO COMMENCING ANY CONSTRUCTION. SIGNS TO REMAIN IN PLACE FOR THE DURATION OF THE PROJECT AND UNTIL COMPLETION AND ACCEPTANCE OF THE PROJECT BY THE HIDALGO COUNTY.

PHASE I

INSTALL ALL SW3P DEVICES ACCORDING TO THE SW3P PLAN AND STANDARDS. ADJUST ALL UTILITIES THAT ARE IN CONFLICT WITH THE PROPOSED CONSTRUCTION. INSTALL PROPOSED DRAINAGE ROADWAY CROSS CULVERTS AND DRIVEWAY/COUNTY ROADSIDE DRAINS AS SHOWN IN THE PLANS. CUT ROADWAY DITCHES TO PROPOSED GRADE ELEVATIONS AS SHOWN IN THE PLANS. CONTRACTOR SHALL MAINTAIN 3:1 MAXIMUM SLOP ADJACENT TO THE ROADWAY TRAVEL SURFACE. EXCAVATED MATERIAL SHALL BE SALVAGED AND USED THROUGHOUT THE PROJECT AS DIRECTED BY THE ENGINEER.

PHASE II

CONSTRUCT PROPOSED ROADWAY IN HALF-SECTIONS, AND ACCORDING TO TCP STANDARD 7/32 TCP (1-2)-98 9/32. THE CONTRACTOR WILL BE REQUIRED TO OPEN UP THE ROADWAY TO TRAFFIC AT THE END OF DAYS WORK. THE CONTRACTOR SHALL ASSURE THAT ALL DROP OFF CONDITIONS ARE SAFE AND IN ACCORDANCE WITH THE MUTCD AND TxDOT TCP STANDARDS. CONTRACTOR SHALL BE ALLOWED TO WORK ON SEVERAL STREETS AT ONE TIME AS LONG AS ACCESS IS MAINTAINED AT THE END OF DAYS WORK.

PHASE III

PLACE FINAL OVERLAY IN ACCORDANCE WITH THE PLANS AND SPECIFICATIONS. COMPLETE ROADWAY DITCH SLOPE GRADES TO MATCH THE TOP EDGE OF THE ACP PAVEMENT.

FINAL CLEAN UP

UPON COMPLETION OF THE WORK AND BEFORE THE FINAL ACCEPTANCE IS MADE, THE CONTRACTOR SHALL SHAPE AND FINISH SUCH PORTIONS OF THE RIGHT-OF-WAY AS MAY HAVE BEEN DISTURBED DURING THE CONSTRUCTION AND WILL BE REQUIRED TO LEAVE THE ENTIRE RIGHT-OF-WAY IN A SMOOTH, CLEAN AND NEAT CONDITIONS TO THE SATISFACTION OF THE ENGINEER.



STANDARD PLANS  
TEXAS DEPARTMENT OF TRANSPORTATION  
Traffic Operations Division

COLONIA ACCESS PROGRAM  
TRAFFIC CONTROL NARRATIVE

HIDALGO COUNTY TEXAS

DN		FED. RD. DIV. NO.	STATE	FEDERAL AID PROJECT NO.	HIGHWAY NO.
CK DN			TEXAS		
DW					
CK DW		STATE DIST. NO.	COUNTY	CONTROL NO.	SECT. NO.
TR			HIDALGO		
CK TR					8

*Handwritten signature and date: 9/2/12*

DISCLAIMER  
The use of this standard is governed by the "Texas Engineering Practice Act". No warranty of any kind is made by TxDOT for any purpose whatsoever. TxDOT assumes no responsibility for the conversion of this standard to other formats or for incorrect results or damages resulting from its use.

DATE:	FILE:
1	1
2	2
3	3
4	4
5	5
6	6
7	7
8	8
9	9
10	10
11	11
12	12
13	13
14	14
15	15
16	16
17	17
18	18
19	19
20	20
21	21
22	22
23	23
24	24
25	25
26	26
27	27
28	28
29	29
30	30
31	31
32	32
33	33
34	34
35	35
36	36
37	37
38	38
39	39
40	40
41	41
42	42
43	43
44	44
45	45
46	46
47	47
48	48
49	49
50	50
51	51
52	52
53	53
54	54
55	55
56	56
57	57
58	58
59	59
60	60
61	61
62	62
63	63
64	64
65	65
66	66
67	67
68	68
69	69
70	70
71	71
72	72
73	73
74	74
75	75
76	76
77	77
78	78
79	79
80	80
81	81
82	82
83	83
84	84
85	85
86	86
87	87
88	88
89	89
90	90
91	91
92	92
93	93
94	94
95	95
96	96
97	97
98	98
99	99
100	100

# PROJECT LIMIT TRAFFIC CONTROL DEVICES

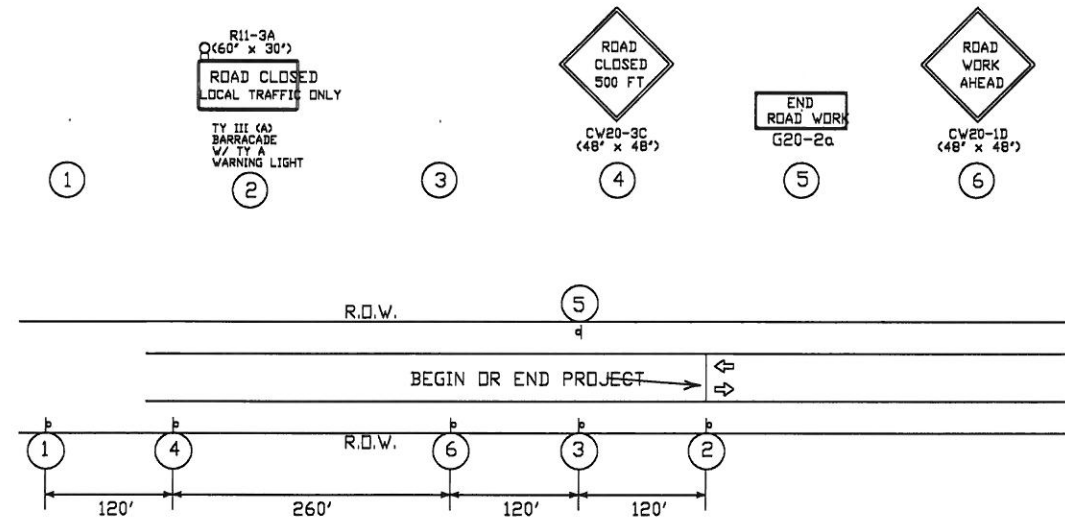

## PROJECT LIMIT GENERAL NOTES

- SIGNS AND WARNING LIGHTS**
- When specified on this sheet or other sheets in the plans, warning lights for a sign shall be installed and maintained by the contractor. Warning lights shall be attached to the sign support using a 1/2" bolt (minimum) of sufficient length for three washers, lock washer and a nut.
  - Warning lights shall be maintained as directed by the Engineer.
  - Appropriate standard traffic control devices shall be used as required by the plans. Any variation in the plans shall be documented by written agreement between the Engineer and the contractor's responsible person.
  - As a general rule, additional traffic control devices in advance of the project limits should only be used in those cases where a work area, a detour, or a potentially hazardous location is less than 2000 feet inside the project limits.
  - The traffic control devices used in the above illustrations are examples only. Field conditions and engineering judgement should dictate the most appropriate traffic control devices to be used. Any variation in the plans shall be documented by written agreement between the Engineer and the contractor's responsible person.
  - As detailed above, the BEGIN ROAD WORK NEXT X MILES, CONTRACTOR and END ROAD WORK signs shall be erected at or near the project limits and the ROAD ZONE TRAFFIC FINES DOUBLE sign with plaque shall be erected in advance of the project limits. These signs should be adjusted to provide adequate spacing to other signs. The OBSERVE WARNING SIGNS STATE LAW sign shall be installed when required elsewhere in the plans.
  - With the agreement of an adjacent project Engineer, the Engineer(s) may allow the omission of END ROAD WORK, TRAFFIC FINES DOUBLE, and other advance warning signs if the signing would be redundant and the work areas appear continuous to the motorists. If the adjacent project is completed first, the contractor will erect the necessary warning signs as shown on these sheets, the TCP sheets or as directed by the Engineer. The BEGIN ROAD WORK NEXT X MILES sign shall be revised to show appropriate work zone distance.
  - Duplicate construction warning signs should be erected on the median side of divided highways where median width will permit and traffic volumes justifies the signing.
  - Except for devices required by Note 6, traffic control devices should be in place only while work is actually in progress or a definite need exists.
  - Sign size should be based on the "Texas Manual on Uniform Traffic Control Devices for Streets and Highways" (TMUTCD).
  - The Special Public Information sign (SG20-8) shall be installed at the project limits when required elsewhere in the plans. Refer to SMD Standards for approved mounting details.

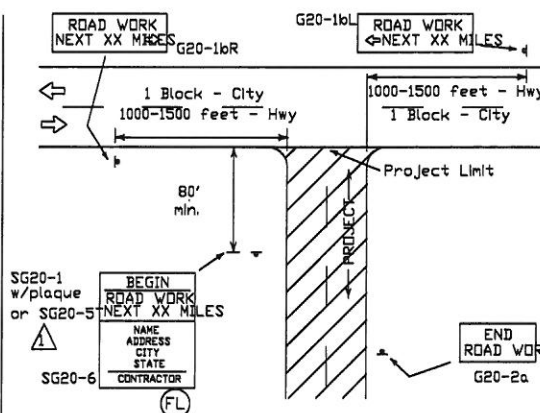

## PROJECT LIMITS AT T-INTERSECTION

- The ROAD WORK NEXT X MILES sign should be erected on the intersected highway as detailed above.
- On the intersected roadway, additional traffic control devices, such as a flagger and accompanying signs or other signs, should be used when work is being performed at or near the intersection.

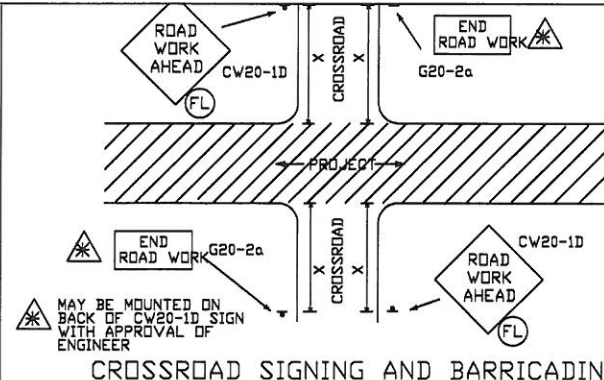

## CROSSROAD SIGNING AND BARRICADING

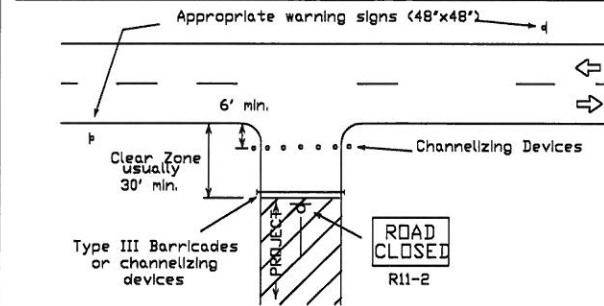

## CULVERT WIDENING OR OTHER ISOLATED WORK WITHIN THE PROJECT LIMITS

Barricades or channelizing devices shall be erected completely across roadway. Channelizing Devices may be drums, vertical panels or cones as specified in the plans.

## PERSPECTIVE

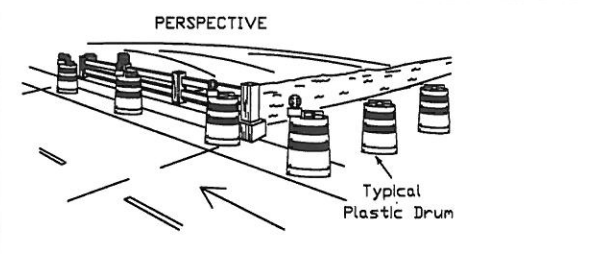

- Where positive redirection capability is provided, drums may be omitted.
- Plastic construction fencing may be used with drums for safety as required in the plans.
- Vertical Panel on flexible support may be substituted for drums when shoulder width is less than 4'.
- When shoulder width is greater than 12', steady-burn lights may be omitted, if drums are used.

These drums are not required on one-way roadway

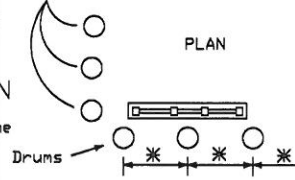

\* Approx. 8' to 10' (maximum) spacing between drums.

Increase number of plastic drums on side of approaching traffic if crown width makes it necessary. (Minimum of 2 and maximum of 4 drums)

**CROSSROAD SIGNING AND BARRICADING**  
1. Except as noted elsewhere in plans, the usual minimum signing on a crossroad approach should be one CW20-1D ROAD WORK AHEAD sign and G20-2a END ROAD WORK sign. Where speeds and volumes are relatively low, a smaller ROAD WORK AHEAD sign may be used.

When approved by the Engineer, on low volume crossroads, advance warning signs may be the reduced size 36" x 36" ROAD WORK AHEAD (MCW20-1D) sign mounted back to back with the reduced size 36" x 18" END ROAD WORK (SG20-2a) sign. See the "STANDARD HIGHWAY SIGN DESIGNS FOR TEXAS" manual and BC(9) thru BC(9C) for sign design details. On low volume crossroads, advance signing may be omitted if approved by the Engineer.

Additional signs such as FLAGGER AHEAD, LOOSE GRAVEL, or other appropriate signs may be required. When additional signs are required, such signs will be considered part of the minimum requirements.  
2. The G20-1a sign shall be required on major crossroads to advise motorists of the length of construction in either direction from the intersection.  
3. On higher volume crossroads additional traffic control devices may be noted elsewhere in the plans.  
4. When work occurs in the intersection area, appropriate traffic control devices shall be in place.

**WARNING LIGHTS**  
Warning lights shall meet the requirements of the "Texas Manual on Uniform Traffic Control Devices for Streets and Highways."  
Warning lights shall NOT be installed on barricades.

Type A-Low Intensity Flashing Warning Lights are commonly used with signs. They are intended to warn of an approaching potentially hazardous area. Their use shall be as indicated on this sheet and/or other sheets of the plans by the designation 'FL'.

Type-C Steady Burn Lights are intended to be used in a series for delineation to supplement other traffic control devices. Their use shall be as indicated on this sheet and/or other sheets of the plans by the designation 'SB'.

## TYPICAL CONSTRUCTION WARNING SIGN SIZE AND SPACING

Roadway Classification	Posted Speed MPH	Sign Spacing 'x'	Long-term or Intermediate-term Stationary Approach Warning Signs		Short-term Stationary Approach Warning Signs		Other Warning Signs
			Standard Inches	Minimum Inches	Standard Inches	Minimum Inches	
Conver.	30	120	48 x 48	36 x 36	30 x 30	24 x 24	30 x 30
	35	160	48 x 48	36 x 36	30 x 30 or 36 x 36	24 x 24 or 30 x 30	36 x 36
	40	240					
	45	320	Use Standard Size	48 x 48	Use Standard Size	48 x 48	
	50	400					
	55	500					
	60	600					
65	700	Use Standard Size	48 x 48	Use Standard Size	48 x 48		
70	800						
Exp or Frey	*	*	*	*	*	*	*

\* For typical sign spacings on expressways and freeways, see TMUTCD typical application diagrams or TCP Standard Sheets.  
\* Minimum distance from work area to 1st Advance Warning sign and/or distance between each additional sign.

\* \* \* Smaller sign sizes may be used where sign designs have been included in the "Standard Highway Sign Designs for Texas" manual.

- General Notes:**
- Special or larger size signs may be used as may be necessary.
  - Distance between signs should be increased as required to have 1500 feet advance warning.
  - For use only on secondary roads or city streets where speeds are low.
  - Only diamond shaped warning sign sizes are indicated.
  - See sign size listing in TMUTCD, Appendix A for complete list of all available sign design sizes.
  - Where two sizes are listed, see sign size listing in TMUTCD, Appendix A for proper size.

Only pre-qualified products shall be used. A list of compliant products and their sources may be obtained by writing or faxing Standards Engineer Traffic Operations Division - TE Texas Department of Transportation 125 East 11th Street Austin, Texas 78701-2483 Phone (512) 416-3120 Fax (512) 416-3151 E-mail TRF-STANDARD@mailgw.dot.state.tx.us



## STANDARD PLANS TEXAS DEPARTMENT OF TRANSPORTATION Traffic Operations Division BARRICADE AND CONSTRUCTION STANDARDS

DN:	FED. RD. DIV. NO.:	STATE:	FEDERAL AID PROJECT NO.:	HIGHWAY NO.:
CK DN:	TEXAS:			
DN:				
CK DN:	STATE DIST. NO.:	COUNTY:	CONTROL. NO.:	SECT. NO.:
TR:	HIDALGO:			
CK TR:				9

DISCLAIMER  
 The use of this standard is governed by the "Texas Engineering Practice Act". No warranty of any kind is made by TxDOT for any purpose whatsoever. TxDOT assumes no responsibility for the conversion of this standard to other formats or for incorrect results or damages resulting from its use.

LEVELS DISPLAYED  
 1 2 3 4 5 6 7 8 9 10 11 12 13 14 15 16  
 ACC: 17 18 19 20 21 22 23 24 25 26 27 28 29 30 31 32  
 33 34 35 36 37 38 39 40 41 42 43 44 45 46 47 48  
 49 50 51 52 53 54 55 56 57 58 59 60 61 62 63

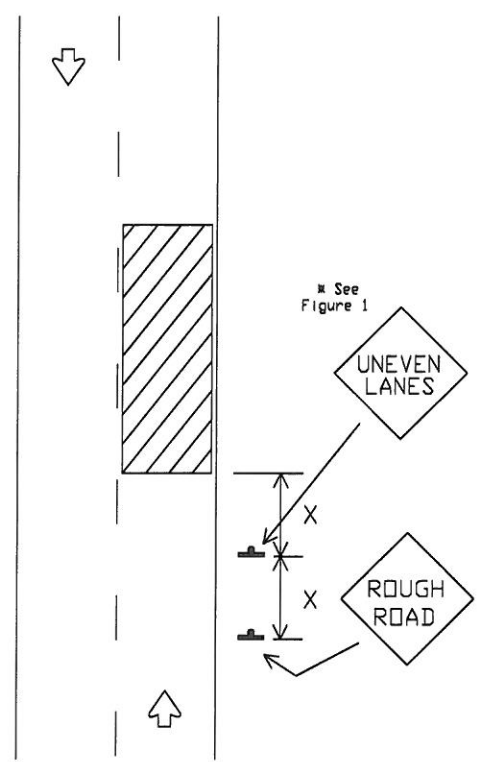

Signing shown for one direction.

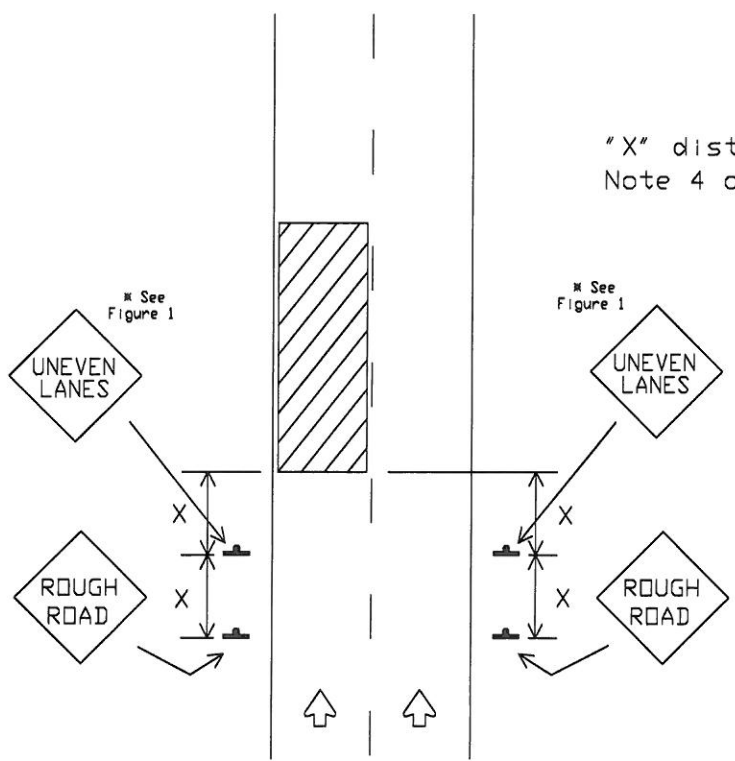
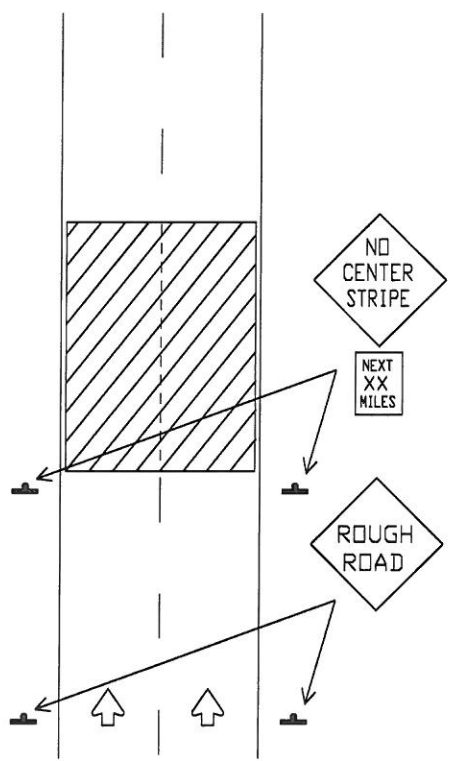
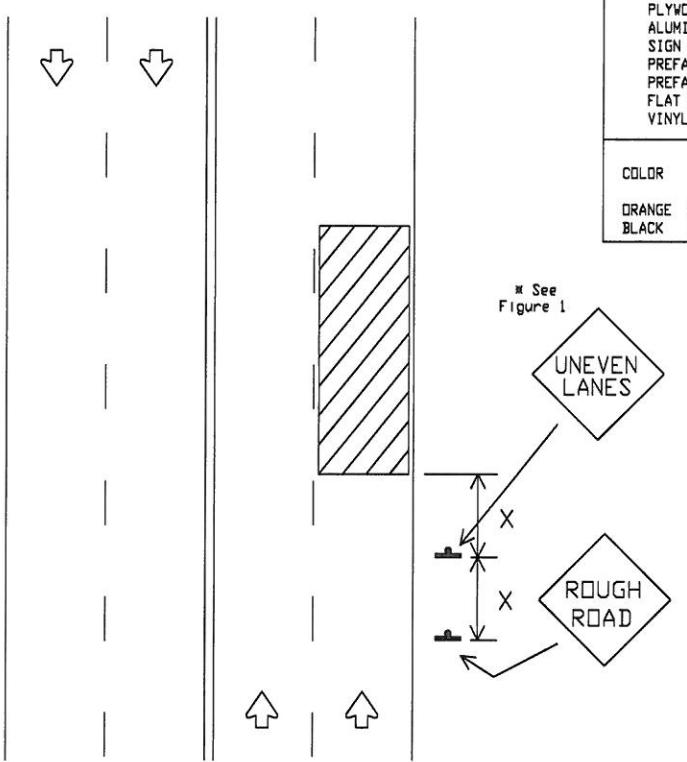

"X" distance - See Note 4 on this page.

DEPARTMENTAL MATERIAL SPECIFICATIONS		
PLYWOOD SIGN BLANKS		DMS-7100
ALUMINUM SIGN BLANKS		DMS-7110
SIGN HARDWARE		DMS-7120
PREFABRICATED PAVEMENT MARKINGS-PERMANENT		DMS-8240
PREFABRICATED PAVEMENT MARKINGS-REMOVABLE		DMS-8241
FLAT SURFACE REFLECTIVE SHEETING		DMS-8300
VINYL NON-REFLECTIVE DECAL SHEETING		DMS-8320
COLOR	USAGE	SHEETING MATERIAL
ORANGE	BACKGROUND	TYPE E (FLUORESCENT PRISMATIC)
BLACK	LEGEND & BORDERS	VINYL NON-REFLECTIVE DECAL SHEETING

- GENERAL NOTES:
1. If spalling or holes occur, ROUGH ROAD signs should be placed in advance of the condition and may be repeated throughout the project.
  2. UNEVEN LANES sign (CW8-11) should be installed in advance of the condition and repeated every mile. Signs installed along the uneven lane condition may be supplemented with the NEXT XX MILES sign (CV21-16) or Advisory Speed sign (CV13-1).
  3. NO CENTER STRIPE signs (CW8-12) should be installed if centerlines or lane lines are obscured or obliterated. The signs should remain in place until permanent pavement markings are installed.
  4. Signs shall be spaced at the distances recommended as per BC standards.
  5. When operations are completed and final surface treatment will not be applied as part of this project, advance signs shall be left in place and become the property of the State. These signs shall be installed on approved permanent sign supports as per TxDOT standards. Additional signs may be required as directed by the Engineer. Minimum mounting height of signs is 7 feet. Signs shall remain in place until final surface is applied. Signs shall be considered subsidiary to the Item "BARRICADES, SIGNS AND TRAFFIC HANDLING."
  6. Pavement markings shall be replaced as operations proceed.
  7. Short term markings shall not be used to simulate edge lines.
  8. All signs shall be constructed in accordance with the details found in the "Standard Highway Sign Designs for Texas," latest edition. Sign details not shown in this manual shall be shown in the plans or the Engineer shall provide a detail to the Contractor before the sign is manufactured.

TRAFFIC CONTROL DURING PLANING, OVERLAY AND LEVELING OPERATIONS ARE SHOWN ELSEWHERE IN THE PLANS.

FIGURE 1		
Edge Condition	Edge Height (D)	Warning Devices
	less than or equal to 1'	Signs: ECW8-8
	greater than 1' to: 1 1/4' (maximum-planing) 1 1/2' (typical-overlay)	Signs: CW8-11, ECW8-8
Distance "D" may be a maximum of 1 1/4' for planing operations and 2' for overlay operations if uneven lanes are open to traffic after work operations cease.		



HIDALGO COUNTY



JAVIER HINOJOSA ENGINEERING CONSULTING ENGINEERS  
 416 E. DOVE AVENUE McALLEN, TEXAS 78504  
 PHONE (956) 868-1588

SIGNS FOR UNEVEN LANES

HIDALGO COUNTY TEXAS



DN:		FED. RD. DIV. NO.	STATE	FEDERAL AID PROJECT NO.	HIGHWAY NO.
CK DN:			TEXAS		31
DN:		STATE DIST. NO.	COUNTY	CONTROL NO.	SECT. NO.
CK DN:			HIDALGO		
TR:				JOB NO.	SHEET NO.
CK TR:					10

MAY, 2012

SCALE: HORIZ: 1"=50'  
VERT: 1"=5'

REVISIONS:

RANDOLPH-BARNETT  
SUBDIVISION No. 1  
PAVING & DRAINAGE  
IMPROVEMENTS  
ELIZABETH STREET  
HIDALGO COUNTY TEXAS

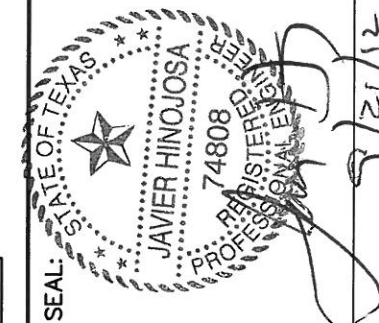

**JH**  
JAVIER HINOJOSA ENGINEERING  
CONSULTING ENGINEERS  
416 E. DOVE AVENUE  
MCALLEN, TEXAS 78504  
PHONE (956) 668-1588

ENGINEER: JAVIER HINOJOSA  
DESIGNER:  
SURVEYOR:  
DRAWN BY: L. HERNANDEZ  
JOB NO.: 120505  
BOOK NO.:  
SHEET NO.: 11

SCHUERBACH RD.

RANDOLPH-BARNETT SUBDIVISION No. 1  
VOL. 22 PG 38 H.C.M.R.

(TO BE RELOCATED)  
ALL EXIST. MAILBOXES

PROP. 24' H.M.A.C.  
28' CALICHE

EXIST. 4" WATER LINE  
(SHARYLAND W.S.C.)

PROP. 15" RCP  
CULVERT FOR DRIVEWAYS  
& SIDEWALKS (TYP)  
(SEE DETAIL SHEET 14)

SCALE:  
HORIZONTAL: 1" = 50'  
VERTICAL: 1" = 5'

LEGEND

- EXIST. GUY WIRE
- CLEAN OUT
- EXIST. POWER POLE
- EXIST. EDGE OF PAVEMENT
- EXIST. CENTER LINE
- EXIST. PALM TREE
- EXIST. 18" CULVERT
- FOUND 1/2 IRON ROD
- FOUND IRON PIPE
- MAILBOX
- BRICK MAILBOX
- TELEPHONE PEDESTAL
- WATERLINE METER
- WATERLINE VALVE
- WATERLINE MARKER
- EXIST. FENCE
- EXIST. PAVEMENT
- PAVEMENT
- CONCRETE DRIVEWAY

MATCH LINE STA 14+00  
SEE SHEET 13

B.M. No. 1  
(TO BE ADJUSTED)  
EXIST. SEWER M.H.  
TOP=161.95

BEGIN PROJECT  
STA. 10+11

P.I. STA. 10+00 ELIZABETH ST.  
SCHUERBACH RD.

EXIST. SEWER M.H.  
TOP=160.94

STREET TURN OUT  
W/ 70 L.F. 18" RC PIPE &  
2 EA. SAFETY END TREATMENTS.  
(SEE DETAIL SHEET 14)

CURB P.C. STA 10+31 RT. & LT.  
C=161.10

RANDOLPH-BARNETT SUBDIVISION No. 1  
VOL. 22 PG 38 H.C.M.R.

ELIZABETH STREET

CURB CURVE DATA					
CURVE	DELTA	RADIUS	TANGENT	LENGTH	CHORD
"1"	90°00'00"	20.00'	20.00'	31.42'	28.28'
"2"	47°43'20"	25.00'	11.06'	20.82'	20.23'

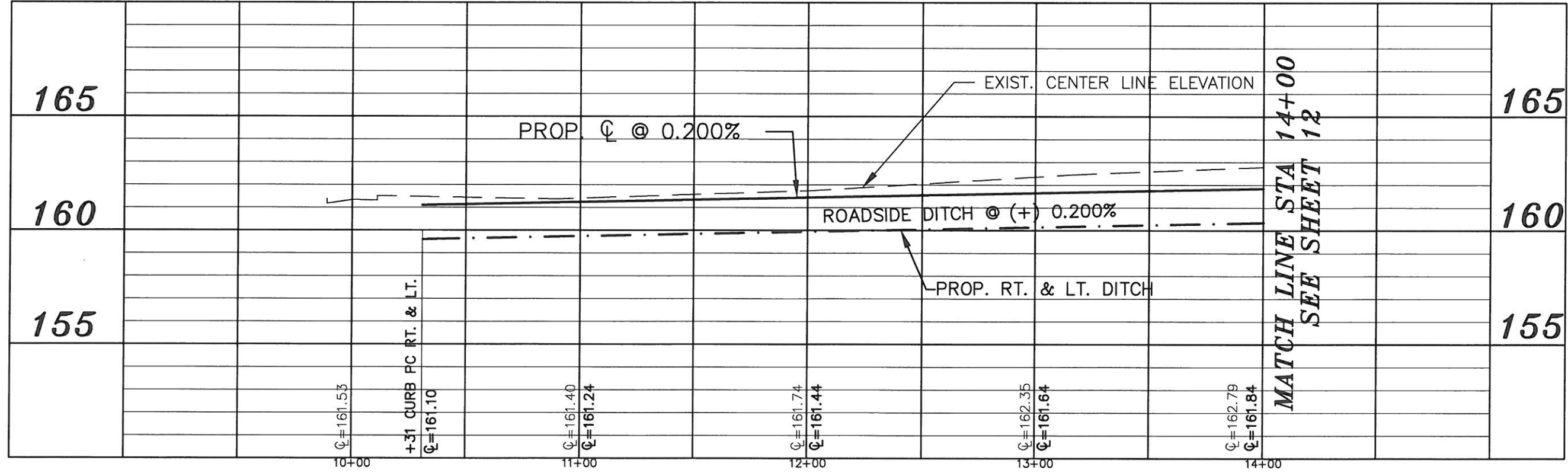

MATCH LINE STA 14+00  
SEE SHEET 12

EXIST. 4" WATER LINE  
(SHARYLAND W.S.C.)

RANDOLPH-BARNETT SUBDIVISION No. 1  
VOL. 22 PG 38 H.C.M.R.

NEW CALEDONIA UNIT No 1

MATCH LINE STA 14+00  
SEE SHEET 12

EXIST. 8" SEWER LINE

CURB P.C. STA 15+79 RT. & LT.  
☉=162.20

**ELIZABETH STREET**

RANDOLPH-BARNETT SUBDIVISION No. 1  
VOL. 22 PG 38 H.C.M.R.

PROP. 15" RCP  
CULVERT FOR DRIVEWAYS  
& SIDEWALKS (TYP)  
(SEE DETAIL SHEET 14)

END PROJECT  
STA. 16+50

P.I. STA. 16+20 ELIZABETH STREET  
☉ RADIUS POINT

SCALE:  
HORIZONTAL: 1" = 50'  
VERTICAL: 1" = 5'

LEGEND

- ↑ EXIST. GUY WIRE
- ⊗ CLEAN OUT
- ⊙ EXIST. POWER POLE
- x EOP=162.81 EXIST. EDGE OF PAVEMENT
- x CL=162.91 EXIST. CENTER LINE
- \* EXIST. PALM TREE
- 18"--- EXIST. 18" CULVERT
- FOUND 1/2" IRON ROD
- ⊙ FOUND IRON PIPE
- ☐ MAILBOX
- ☐ BRICK MAILBOX
- ☐ TELEPHONE PEDESTAL
- ☐ WATERLINE METER
- ☐ WATERLINE VALVE
- ☐ WATERLINE MARKER
- ⊗ EXIST. FENCE
- ▨ EXIST. PAVEMENT
- ▨ PAVEMENT
- ▨ CONCRETE DRIVEWAY

RANDOLPH-BARNETT  
SUBDIVISION No. 1  
PAVING & DRAINAGE  
IMPROVEMENTS  
ELIZABETH STREET  
HIDALGO COUNTY TEXAS

CURB CURVE DATA					
CURVE	DELTA	RADIUS	TANGENT	LENGTH	CHORD
"2"	47°43'20"	25.00'	11.06'	20.82'	20.23'
"2"	47°43'20"	25.00'	11.06'	20.82'	20.23'
"3"	275°26'39"	30.00'	27.28'	144.22'	40.36'



**JH**  
JAVIER HINOJOSA ENGINEERING  
CONSULTING ENGINEERS  
416 E. DOVE AVENUE  
McALLEN, TEXAS 78504  
PHONE (956) 668-1568

ENGINEER: JAVIER HINOJOSA  
DESIGNER:  
SURVEYOR:  
DRAWN BY: L. HERNANDEZ  
JOB NO.: 120505  
BOOK NO.:  
SHEET NO.: 12

165	MATCH LINE STA 14+00 SEE SHEET 11	EXIST. CENTER LINE ELEVATION	165
		PROP. ☉ @ 0.200%	
160	MATCH LINE STA 14+00 SEE SHEET 11	ROADSIDE DITCH @ (+) 0.200%	160
		PROP. RT. & LT. DITCH	
155	MATCH LINE STA 14+00 SEE SHEET 11	PROP. RT. & LT. DITCH	155
		+79 CURB PC RT. & LT. ☉=162.20	

☉=162.79  
☉=161.84

☉=162.95  
☉=162.04

+79 CURB PC RT. & LT.  
☉=162.20

14+00

15+00

16+00

17+00

RANDOLPH BARNETT SUBDIVISION No. 1

ELIZABETH STREET	Exist. Drwy Width (ft.)	EXIST. R.C.P. 16" (CL III) (ft.)	Prop. Width @ Edge of Rdwy. (ft.)	Prop. Width @ R.O.W. Line (ft.)	Item 530 Drwy Area (SY)			Item 556 15" COR. ADS PIPE (ft.)	PROP. FL ADS PIPE	
					CONCRETE	ASPHALT	PB-1		UP STREAM (ft.)	DOWN STREAM (ft.)
10+37 (RT.)	14	--	20	14	25			25	159.64	159.59
10+56 (LT.)	14	--	20	14		25		25	159.68	159.62
11+28 (LT.)	16	--	22	16	27			25	159.83	159.77
11+38 (RT.)	16	--	22	16	27			25	159.84	159.78
11+66 (RT.)	16	--	22	16	27			25	159.90	159.84
12+18 (LT.)	16	--	22	16		27		25	160.00	159.94
12+25 (RT.)	12	--	18	12		22		25	160.02	159.96
12+54 (RT.)	14	--	20	14		25		25	160.07	160.01
12+70 (RT.)	14	--	20	14		25		25	160.11	160.05
13+10 (LT.)	14	--	20	14	25			25	160.19	160.13
13+32 (LT.)	16	--	22	16		27		25	160.23	160.17
13+48 (RT.)	14	--	20	14		25		25	160.26	160.20
13+62 (LT.)	12	--	18	12		22		25	160.29	160.23
13+98 (RT.)	14	--	20	14		25		25	160.36	160.30
14+00 (LT.)	16	--	22	16		32		25	160.37	160.31
14+42 (LT.)	14	--	20	14		29		25	160.45	160.39
14+46 (RT.)	12	--	18	12	22			25	160.46	160.40
15+00 (LT.)	16	--	22	16		27		25	160.57	160.51
15+00 (RT.)	14	--	20	14		25		25	160.57	160.51
15+58 (LT.)	14	--	20	14		25		25	160.68	160.62
15+79 (RT.)	14	--	20	14		25		25	160.72	160.65
16+07 (RT.)	12	--	18	12		22		25	160.74	160.68
16+18 (LT.)	12	--	18	12		22		25	160.76	160.70
16+36 (RT.)	20	--	26	20		33		25	160.80	160.74
TOTAL					153	454		600		

\* NOTE: ALL EXISTING CONCRETE DRIVEWAYS TO BE PAVED WITH CONCRETE FROM R.O.W. LINE TO PROPOSED EDGE OF PAVEMENT (SEE SHEET ("DRIVEWAY DETAILS"))



**HIDALGO COUNTY**



**JAVIER HINOJOSA ENGINEERING**  
CONSULTING ENGINEERS  
416 E. DOVE AVENUE McALLEN, TEXAS 78504  
PHONE (956) 668-1588

**DRIVEWAY SUMMARY TABLE**

**HIDALGO COUNTY TEXAS**

DN:		FED. RD. DIV. NO.:	STATE:	FEDERAL AID PROJECT NO.:	HIGHWAY NO.:
CK DN:			TEXAS		31
DN:					
CK DN:		STATE DIST. NO.:	COUNTY:	CONTROL. NO.:	SECT. NO.:
TR:			HIDALGO		
CK TR:					13



9/21/12

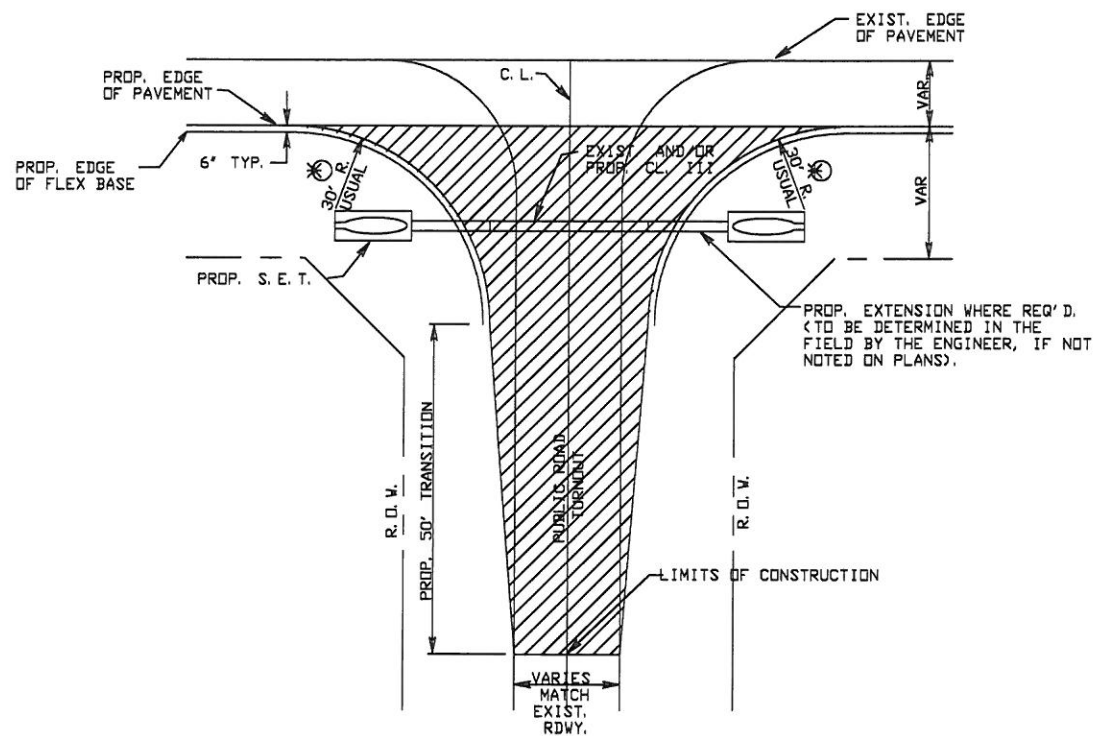

**TYPICAL DETAIL**  
(WHEN EXIST. ROADWAY WIDTH LESS THAN 24'.)

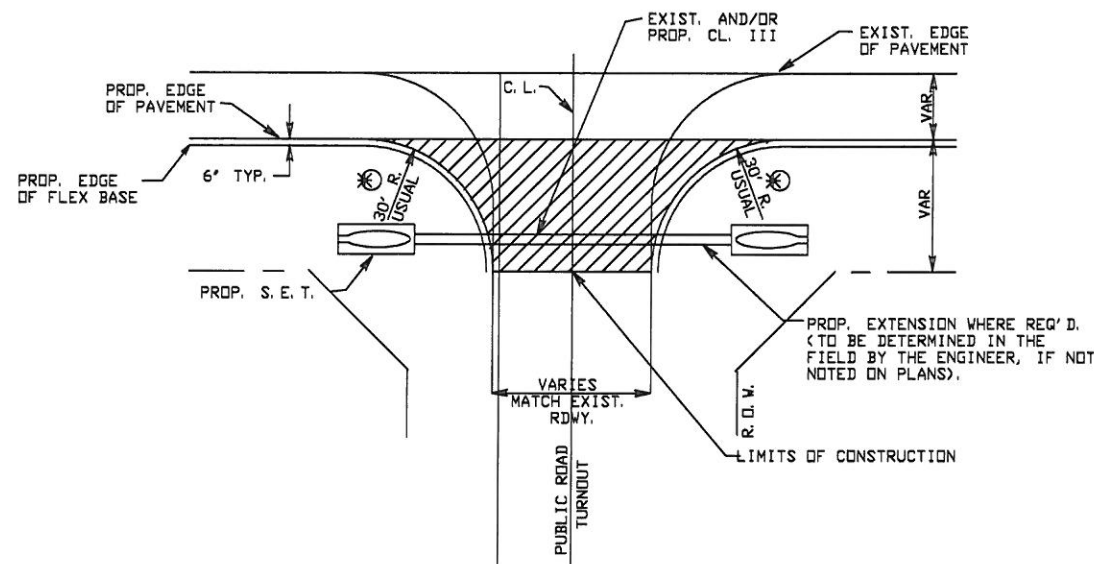

**TYPICAL DETAIL**  
(WHEN EXIST. ROADWAY WIDTH EQUAL TO OR GREATER THAN 24'.)

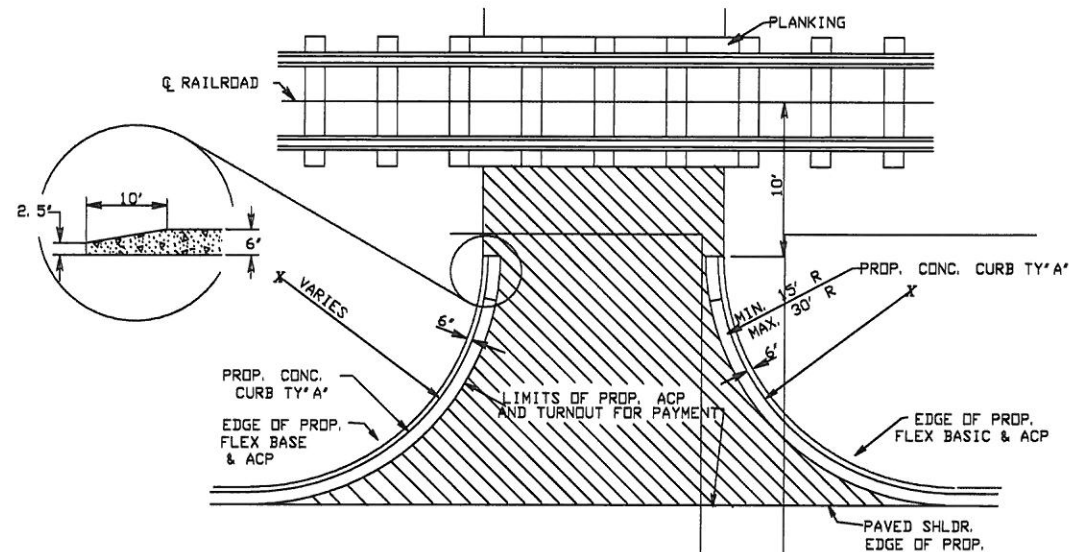

**PLAN OF PUBLIC TURNOUT ADJACENT TO R. R. CROSSING**

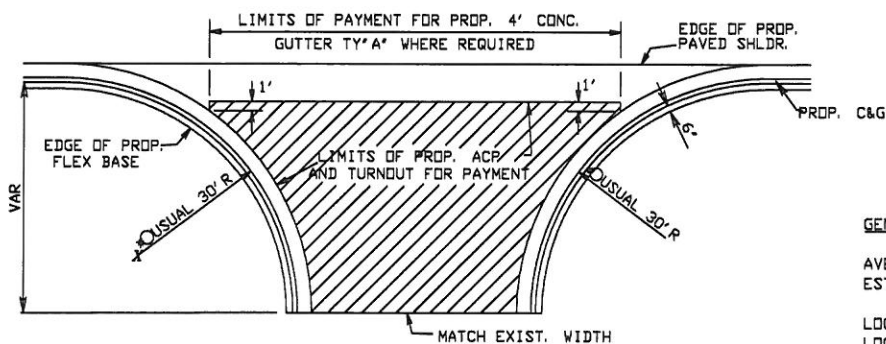

**PLAN OF PUBLIC TURNOUT**

**GENERAL NOTES:**

AVERAGE DIMENSIONS SHOWN ON TABLE OF TURNOUTS ARE FOR ESTIMATING PURPOSES ONLY.

LOCATIONS LISTED ON THE TABLE ARE APPROXIMATE, EXACT LOCATIONS, DIMENSIONS, AND TYPE TO BE ESTABLISHED DURING CONSTRUCTION BY THE ENGINEER AS REQUIRED.

SEE DRIVEWAY & TURNOUT TABLE TURNING RADIUS MAY BE REDUCED AS APPROVED BY THE ENGINEER.

**TY P**

EXIST. PAVED TURNOUTS TO BE SURFACED W/171#/SY ACP.

**TY PRB1**

EXIST. PAVED, CALICHE AND/OR GRAVEL TURNOUTS TO BE SCARIFIED AND RECONSTRUCTED WITH 4' NEW FLEX. BASE W/1% LIME TO MATCH THE PROPOSED WIDENED SECTION, THEN PRIMED AND SURFACED WITH 171#/SY ACP

**TY PBS1**

EXIST. UNPAVED PUBLIC TURNOUTS TO BE CONSTRUCTED AS SHOWN WITH 12' LIME TREAT. SUBGRADE, 8' FLEX. BASE 1% LIME, THEN PRIMED AND SURFACED WITH 171#/SY ACP.

**TY PBS2**

EXIST. TURNOUT TO BE CONSTRUCTED SAME AS ROADWAY.



**STANDARD PLANS**  
TEXAS DEPARTMENT OF TRANSPORTATION  
Traffic Operations Division

**TURNOUT DETAILS**

**HIDALGO COUNTY TEXAS**

DN:		FED. RD. DIV. NO.	STATE	FEDERAL AID PROJECT NO.	HIGHWAY NO.
CK DN:			TEXAS		
DW:					
CK DW:		STATE DIST. NO.	COUNTY	CONTROL NO.	SECT. NO.
TR:			HIDALGO		
CK TR:					14

PRIVATE AND COMMERCIAL DRIVES WITH CURB & GUTTER

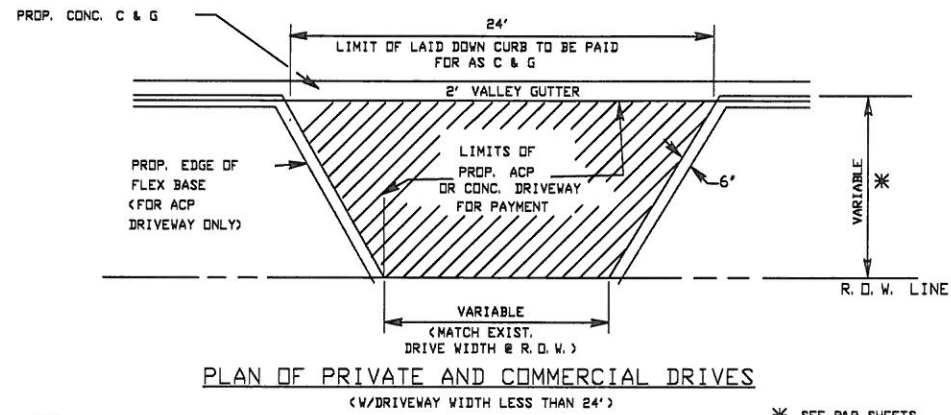

⊗ SEE NOTE BELOW

\* SEE P&P SHEETS

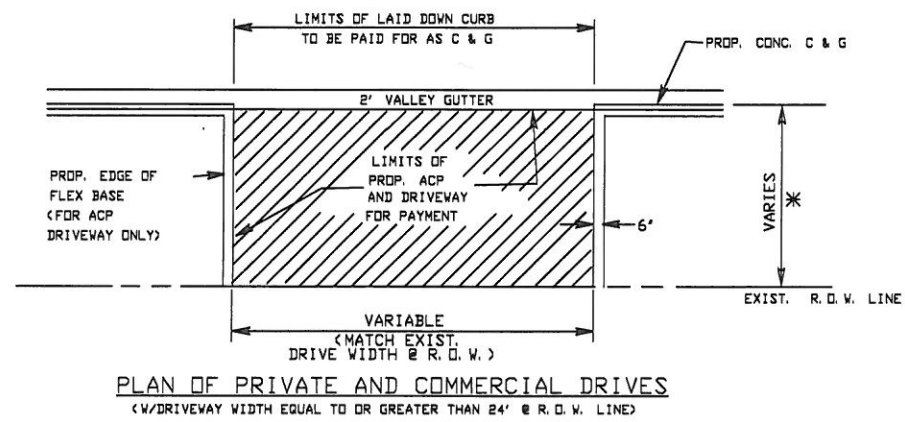

PRIVATE AND COMMERCIAL DRIVES WITHOUT CURB & GUTTER

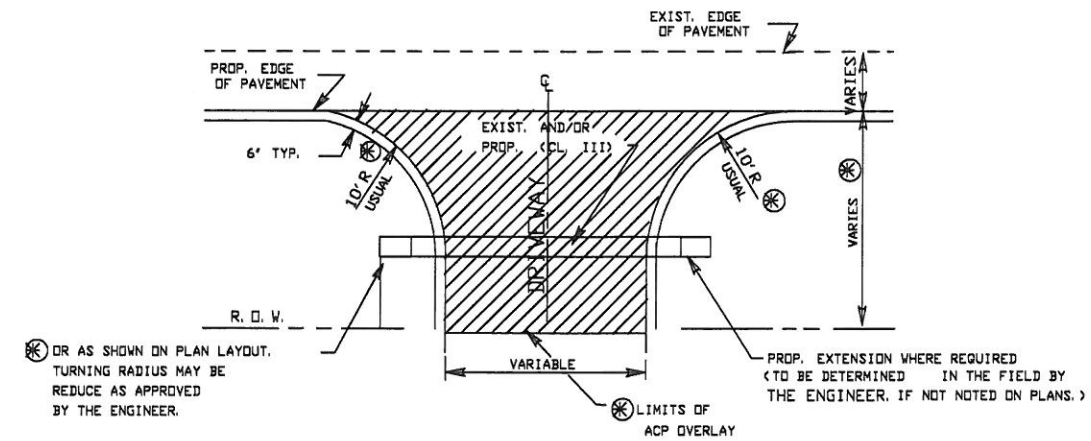

⊗ OR AS SHOWN ON PLAN LAYOUT. TURNING RADIUS MAY BE REDUCE AS APPROVED BY THE ENGINEER.

PROG. EXTENSION WHERE REQUIRED (TO BE DETERMINED IN THE FIELD BY THE ENGINEER, IF NOT NOTED ON PLANS.)

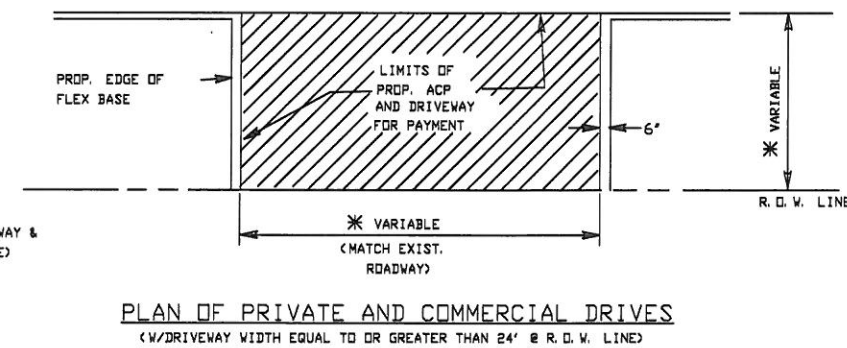

\* FOR DETAILS SEE DRIVEWAY & TURNOUT DETAILS (TABLE)

PRIVATE AND COMMERCIAL DRIVES WITH CURB & GUTTER

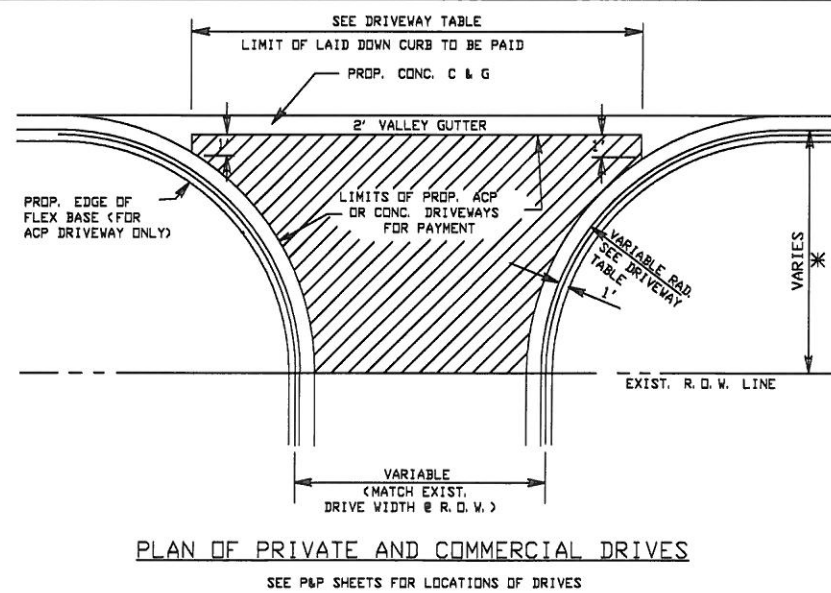

⊗ NOTE

DRIVEWAY TYPES

- TY PRB-1  
EXIST. PAVED CALICHE AND /OR GRAVEL DRIVEWAYS TO BE SCARIFIED AND RECONSTRUCTED WITH 3" NEW AND/OR SALVAGE FLEX. BASE TO MATCH THE PROPOSED WIDENED SECTION. THEN PRIMED AND SURFACED WITH 114#/SY ACP (TY 'D')
- TY PB-1  
EXIST. UNPAVED PRIVATE OR COMMERCIAL DRIVEWAYS TO BE CONSTRUCTED AS SHOWN WITH 4" NEW AND/OR SALVAGE FLEX. BASE, PRIMED AND SURFACED WITH 114#/SY ACP.
- TY P1  
EXIST. PAVED DRIVEWAYS TO BE PAVED WITH 114#/SY ACP TY 'D'.

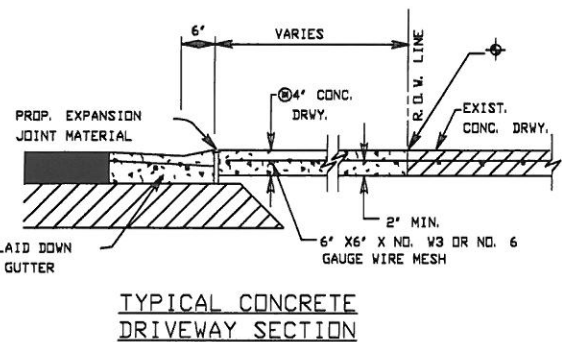

⊕ CONC. SHALL BE SAW CUT TO THE LIMITS OF REMOVAL WHERE APPLICABLE.

⊙ 6' FOR COMMERCIAL DRIVES



TEXAS DEPARTMENT OF TRANSPORTATION

### DRIVEWAY DETAILS

DN:	FED. RD. DIV. NO.	STATE	FEDERAL AID PROJECT NO.	HIGHWAY NO.
DN:		TEXAS		
CK DN:	STATE DIST. NO.	COUNTY	CONTROL. NO.	SECT. NO.
TR:		HIDALGO		
CK TR:				15

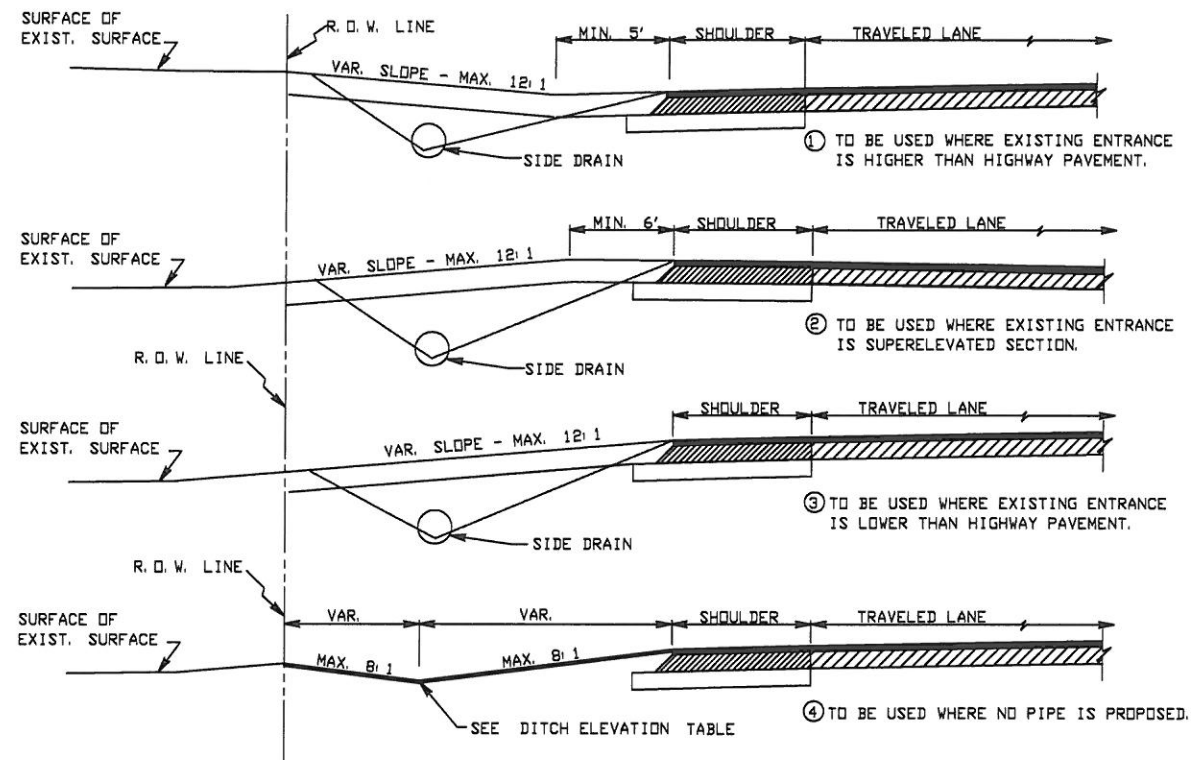

TYPICAL ENTRANCE PROFILE FOR DRIVEWAYS W/OUT C&G

**NOTES:**

ALL ENTRANCES CONSTRUCTED ON THIS PROJECT ARE SUBJECT TO CONCURRENCE WITH EXISTING GOVERNING REGULATIONS AS SET OUT BY THE STATE HIGHWAY COMMISSION.

BASE AND SURFACING MAY BE EXTENDED BEYOND R. D. W. LINE AS REQUIRED TO MEET EXISTING GRADE IN A SATISFACTORY MANNER.

ALL FLEXIBLE BASE USED FOR PRIVATE DRIVES & DRIVES WILL NOT REQUIRE LIME TREATMENT.

EXACT LOCATIONS, DIMENSIONS, AND TYPE TO BE ESTABLISHED DURING CONSTRUCTION BY THE ENGINEER.

PROP. WIDTH OF DRIVEWAYS AND TURNOUTS TO MATCH EXISTING WIDTH AT R. D. W. LINE.

114 #/SY ACP (COMPACTED) IS EQUAL TO 1 IN. DEPTH  
171 #/SY ACP (COMPACTED) IS EQUAL TO 1 1/2 IN. DEPTH.

SIDE DRAINS TO BE INSTALLED WHERE ROADWAY DITCH DRAINAGE IS NECESSARY AS INDICATED ON PLANS AND/OR AS DIRECTED BY THE ENGINEER.

AVERAGE DIMENSIONS SHOWN ON TABLE OF DRIVEWAYS AND TURNOUTS ARE FOR ESTIMATING PURPOSES ONLY.

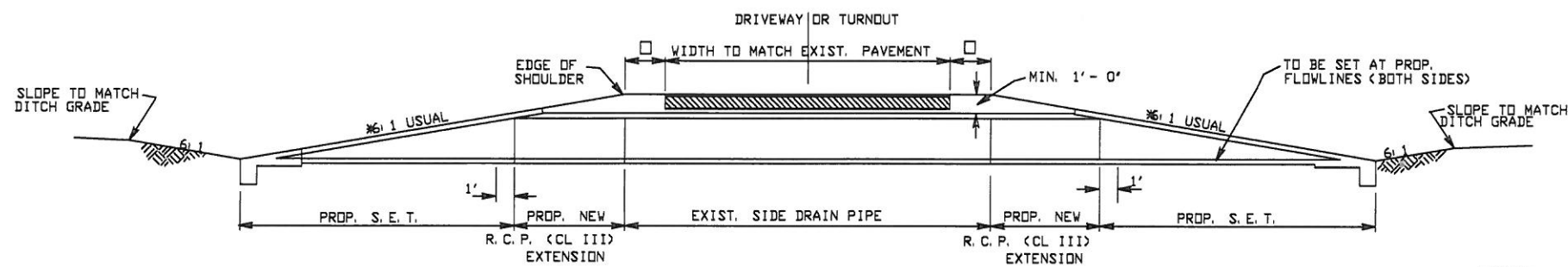

- - 1' MIN. ON DRIVEWAYS  
2' MIN. ON TURNOUTS
- \* - 6:1 SLOPE USUAL  
UNLESS OTHERWISE NOTED ON PLANS



**TEXAS DEPARTMENT OF TRANSPORTATION**

**DRIVEWAYS & TURNOUTS  
PROFILE DETAILS**

DN#		FED. RD. DIV. NO.	STATE	FEDERAL AID PROJECT NO.	HIGHWAY NO.
CK DN#			TEXAS		
DN#					
CK DW#		STATE DIST. NO.	COUNTY	CONTROL NO.	SECT. NO.
TR#					JOB NO.
CK TR#			HIDALGO		SHEET NO. 16

**SITE DESCRIPTION**

PROJECT LIMITS: RANDOLPH BARNETT SUBDIVISION No. 1  
CSJ: 3C-M1080-600 ELIZABETH STREET

PROJECT DESCRIPTION: Construction of a non-freeway facility consisting of grading, lime treated sub grade, flex-base, asphaltic concrete pavement road side ditches, signing, striping and storm water pollution control devices.

MAJOR SOIL DISTURBING ACTIVITIES: preparing the right-of-way roadway embankment roadway excavation grading clearing and grubbing erosion & sediment controls storm drain, culvert & Irrigation structure installations

TOTAL PROJECT AREA: 5.00 acres

TOTAL AREA TO BE DISTURBED: 0.746 acres

WEIGHTED RUNOFF COEFFICIENT (AFTER CONSTRUCTION): 80%

EXISTING CONDITION OF SOIL & VEGETATIVE COVER AND % OF EXISTING VEGETATIVE COVER: Existing soil consist of two different soil types. These soils consist of Hidalgo fine sandy loam and Hidalgo sandy clay loam. However portion within the right-of-way is covered with the existing paved roadway. The remaining is covered with various grasses which are in fair condition.

NAME OF RECEIVING WATERS: Drainage from offsite and onsite will be drained to roadside ditches. Drainage to be maintained as per existing conditions.

**EROSION AND SEDIMENT CONTROLS**

SOIL STABILIZATION PRACTICES:

- TEMPORARY SEEDING
- PERMANENT PLANTING, SODDING, OR SEEDING
- MULCHING
- SOIL RETENTION BLANKET
- BUFFER ZONES
- PRESERVATION OF NATURAL RESOURCES

OTHER: Disturbed areas on which construction activity has ceased (temporarily or permanently) shall be stabilized within 14 days unless activities are scheduled to resume within 21 days.

STRUCTURAL PRACTICES:

- SILT FENCES
- HAY BALES
- ROCK BERMS
- DIVERSION, INTERCEPTOR, OR PERIMETER DIKES
- DIVERSION, INTERCEPTOR, OR PERIMETER SWALES
- DIVERSION DIKE AND SWALE COMBINATIONS
- PIPE SLOPE DRAINS
- PAVED FLUMES
- ROCK BEDDING AT CONSTRUCTION EXIT
- TIMBER MATTING AT CONSTRUCTION EXIT
- CHANNEL LINERS
- SEDIMENT TRAPS
- SEDIMENT BASINS
- STORM INLET SEDIMENT TRAP
- STONE OUTLET STRUCTURES
- CURBS AND GUTTERS
- STORM SEWERS
- VELOCITY CONTROL DEVICES

OTHER: \_\_\_\_\_

NARRATIVE - SEQUENCE OF CONSTRUCTION (STORM WATER MANAGEMENT) ACTIVITIES:

- The order of activities will be as follows:
1. Install controls for ingress and egress into the project site.
  2. Install sediment control fences at locations as shown on the plans or as directed by the engineer.
  3. Seed entire remaining disturbed area between proposed roadway pavements and the project's right of way limits.
  4. When all construction activity is complete and the site is stabilized and approved by the Project Engineer, remove all temporary erosion controls and stabilize any areas disturbed by their removal.

STORM WATER MANAGEMENT: Storm water drainage will be provided by open road side ditches. This system will carry drainage within and outside the R.O.W. to lows in the roadway where drainage occurs and ultimately will drain as per existing conditions.

"I certify under penalty of law that this document and all attachments were prepared under my direction or supervision in accordance with a system designed to assure that qualified personnel properly gathered and evaluated the information submitted. Based on my inquiry of the person or persons who manage the system, or those persons directly responsible for gathering the information, the information submitted is, to the best of my knowledge and belief, true, accurate, and complete. I am aware that there are significant penalties for submitting false information, including the possibility of fine and imprisonment for known violations."

OTHER EROSION AND SEDIMENT CONTROLS:

MAINTENANCE: All erosion and sediment controls will be maintained in good working order. If a repair is necessary, it will be done at the earliest date possible, but no later than 7 calendar days after the surrounding exposed ground has dried sufficiently to prevent further damage from heavy equipment. The areas adjacent to creeks and drainageways shall have priority followed by devices protecting storm drain inlets.

INSPECTION: An inspection will be performed by an authorized inspector every week as well as after every half inch or more of rain (as recorded on a non-freezing rain gauge to be located at the Project Site). An inspection and Maintenance Report will be made per each Inspection. Based on the inspection results, the controls shall be revised per the inspection report.

WASTE MATERIALS: All waste materials will be collected and stored in a securely lidded dumpster meeting all state and local city solid waste management regulations, or as required by local regulations. All trash and construction debris from the site will be deposited as necessary at a local dump. No construction waste material will be buried on site.

HAZARDOUS WASTE (INCLUDING SPILL REPORTING): At a minimum, any products in the following categories to be hazardous: Paints, Acids for cleaning masonry surfaces, Cleaning Solvents, Asphalt products, Chemical additives for soil stabilization, or Concrete curing compounds and additives. In the event of a spill which may be hazardous, the spill Coordinator should be contacted immediately. Emptying of excess concrete should not be allowed onsite. Likewise, washout of concrete trucks should not be performed onsite. These discharges are considered non-allowable non-storm water discharges. Concrete trucks should never be allowed to dump into storm drains or sanitary sewers.

SANITARY WASTE: All sanitary waste will be collected from the portable units as necessary or as required by local regulation by a licensed sanitary waste management contractor.

OFFSITE VEHICLE TRACKING:

- HAUL ROADS DAMPENED FOR DUST CONTROL
- LOADED HAUL TRUCKS TO BE COVERED WITH TARPULIN
- EXCESS DIRT ON ROAD REMOVED DAILY
- STABILIZED CONSTRUCTION ENTRANCE

OTHER: \_\_\_\_\_

REMARKS: Disposal areas, stockpiles, and haul roads shall be constructed in a manner that will minimize and control the amount of sediment that may enter receiving waters. Disposal areas shall not be located in any wetland, waterbody or streambed. Construction staging areas and vehicle maintenance areas shall be constructed by the contractor in a manner to minimize the runoff of pollutants. All waterways shall be cleared as soon as practicable of temporary embankment, temporary bridges, matting, falsework, piling, debris, or other obstructions placed during construction operations that are not a part of the finished work.

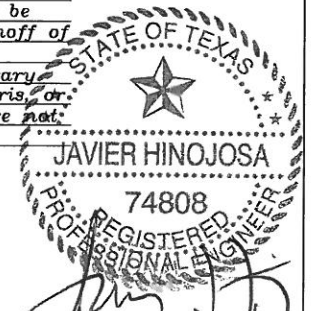

**BORDER ACCESS COLONIA PROJECT  
 VARIOUS SUBDIVISIONS  
 TxDOT STORM WATER POLLUTION  
 PREVENTION PLAN (SW3P)**

HIDALGO COUNTY, TEXAS

**J E H**  
**JAVIER HINOJOSA ENGINEERING  
 CONSULTING ENGINEERS**  
 418 E. DOVE AVENUE McALLEN, TEXAS 78804  
 PHONE (361) 688-1808

© 1999 TxDOT		FEDERAL AID PROJECT NO.	SHEET NO.
6			17
STATE	STATE DISTRICT	COUNTY	
TEXAS	PHR	HIDALGO	
CONT.	SECT.	JOB	HIGHWAY NO.
			COLONIAS

DISCLAIMER: The use of this standard is governed by the Texas Engineering Practices Act. No warranty of any kind is made by TxDOT for any purpose whatsoever. TxDOT assumes no responsibility for the conversion of this standard to other formats or for incorrect results or damages resulting from its use.

FILE: E:\Civl-02\00-204 Trenton Rd\SW3P\SW3P.DWG

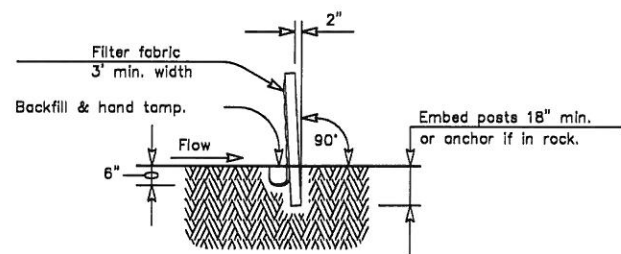

SECTION A-A

**SEDIMENT CONTROL FENCE USAGE GUIDELINES**

A sediment control fence may be constructed near the downstream perimeter of a disturbed area along a contour to intercept sediment from overland runoff. A 2 year storm frequency may be used to calculate the flow rate to be filtered.

Sediment control fence should be sized to filter a max. flow through rate of 100 GPM/FT. Sediment control fence is not recommended to control erosion from a drainage area larger than 2 acres.

**PLAN SHEET LEGEND**

Sediment Control Fence — SCF

**GENERAL NOTES**

1. The guidelines shown hereon are suggestions only and may be modified by the Engineer.

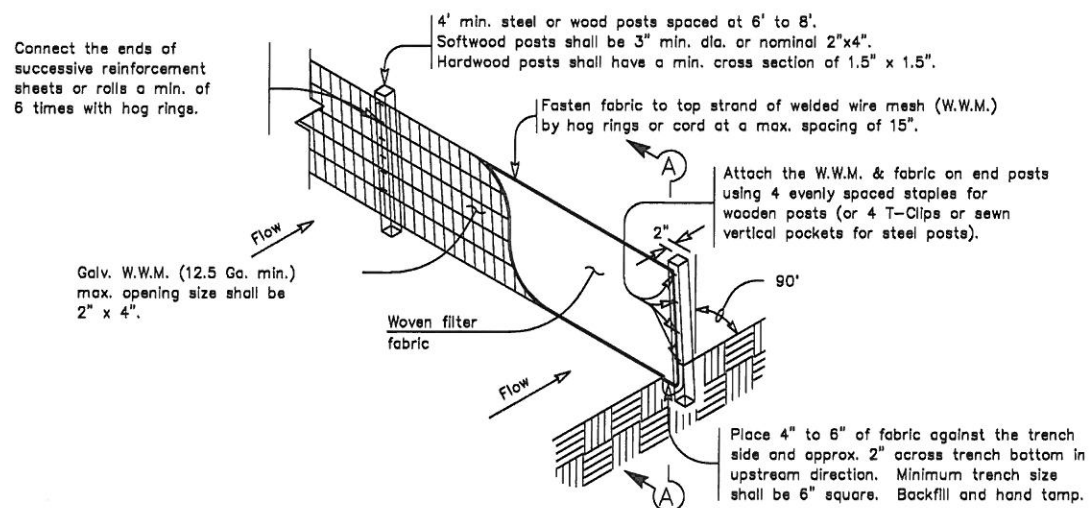

TEMPORARY SEDIMENT CONTROL FENCE

SCF

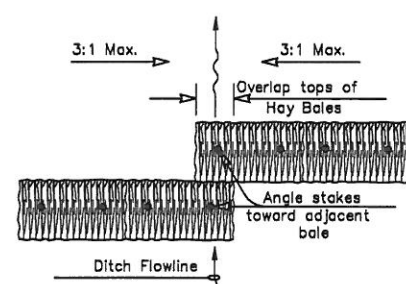

PLAN VIEW

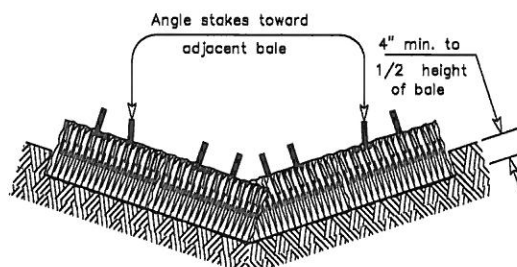

PROFILE VIEW

**PLANS SHEET LEGEND**

Baled Hay — BH

**BALED HAY USAGE GUIDELINES**

A Baled Hay installation may be constructed near the downstream perimeter of a disturbed area along a contour to intercept sediment from overland runoff. A two year storm frequency may be used to calculate the flow rate to be filtered. The installation should be sized to filter a maximum flow thru rate of 5 GPM/FT<sup>2</sup> of cross sectional area. Baled hay may be used at the following locations:

1. Where the runoff approaching the baled hay flows over disturbed soil for less than 100'. If the slope of the disturbed soil exceeds 10%, the length of slope upstream the baled hay should be less than 50'.
2. Where the installation will be required for less than 3 months.
3. Where the contributing drainage area is less than 1/2 acre.

For Baled Hay installations in small ditches, the additional following considerations apply:

1. The ditch sideslopes should be graded as flat as possible to maximize the drainage flowrate thru the hay.
2. The ditch should be graded large enough to contain the overtopping drainage when sediment has filled to the top of the baled hay.

Bales should be replaced usually every 2 months or more often during wet weather when loss of structural integrity is accelerated.

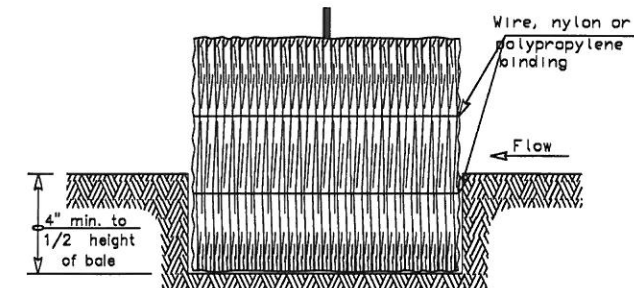

SECTION B-B

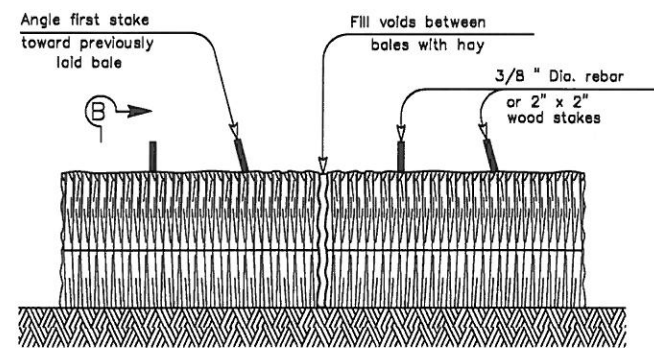

BALED HAY FOR EROSION CONTROL

BH

**GENERAL NOTES**

1. Hay bales shall be a minimum of 30" in length and weigh a minimum of 50 Lbs.
2. Hay bales shall be bound by either wire or nylon or polypropylene string. The bales shall be composed entirely of vegetative matter.
3. Hay bales shall be embedded in the soil a minimum of 4" and 3. Hay bales shall be embedded in the soil a minimum of 4" and where possible, the height of the bale
4. Hay bales shall be placed in a row with ends tightly abutting the adjacent bales. The bales shall be placed with bindings parallel to the ground.
5. Hay bales shall be securely anchored in place with 3/8" Dia. rebar or 2" x 2" wood stakes, driven through the bales. The first stake shall be angled towards the previously laid bale to force the bales together.
6. The guidelines shown hereon are suggestions only and may be modified by the Engineer.



9/21/12

**STANDARD PLANS**  
**TEXAS DEPARTMENT OF TRANSPORTATION**  
*Traffic Operations Division*

**REGULATORY SIGNS**

DN:		FED. RD. DIV. NO.:		STATE:		FEDERAL AID PROJECT NO.:		HIGHWAY NO.:	
CK DN:				TEXAS					
DW:									
CK DW:		STATE DIST. NO.:		COUNTY:		CONTROL NO.:		SECT. NO.:	
TR:				HIDALGO					
CK TR:									18