



lighting > electrical > energy
technology > signs



April 9, 2014
Pct. 2 Hidalgo County

ml

Reference: Little Mexico ~~H~~ subdivision- Solar lighting installation 10%off BB List price

We propose to install (15) TPN-1TF2E600Q4H-3D-P25-10 Sol light fixtures on a 25' Aluminum pole. These will be installed in locations specified by the county on drawings. As requested, these will also be installed on a concrete base. All locations will need to be called to one call for location of all utilities in order to dig and pour bases in locations specified.

(15) TPN-1TF2E60-Q4H-3D-P25-10 on a aluminum pole @ \$7,656.30 =\$114,844.50
(15) Labor units to install all concrete base and locating.....20 hours per pole (15) Poles/fixture/bases =300 hours @\$65.00 per hour =\$19,500.00

Total turnkey project installation cost is \$134,344.50

These fixtures are listed on the Texas State Buy Board contract #437-13 Facility Solutions Group is also an approved installer on the Buy Board

Thank you for the Opportunity in allowing us to work with you.

Sincerely,
Antonio Olivares LEED AP BD+C
Lighting/Electrical
956-821-8648

8018 West Expressway 83, Harlingen TX. 78552 • 956-797-4191
Regulated by The Texas Department of Licensing and Regulation, P.O. Box 12157
Austin, Texas 78711, 1-800-803-9202, 512-463-6599; TECL #25589
Website: www.license.state.tx.us/complaints

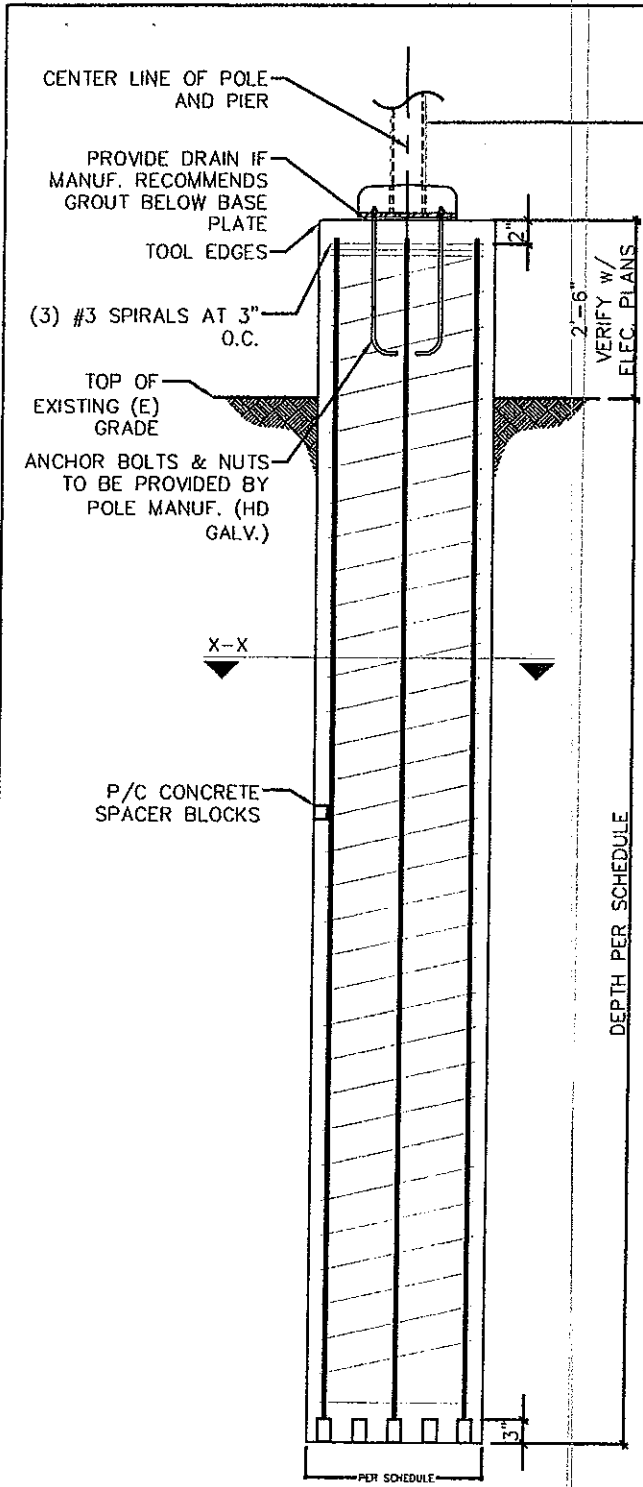

NOTE:

1. WARRANTY SHOULD INCLUDE NATURALLY OCCURRING HARMONIC VIBRATION LIGHT POLE FAILURES.
2. FACTORY INSTALLED VIBRATION DAMPERS TO BE PROVIDED BY THE LIGHT POLE MANUFACTURER.
3. LIGHT POLE MANUFACTURER SHALL SPECIFY THE REQUIRED DIAMETER AND EMBEDMENT OF THE ANCHOR BOLTS. EMBEDMENT SHALL BE SUFFICIENT TO PREVENT CONICAL SHEAR OF THE CONCRETE.
4. A MAINTENANCE PLAN SHOULD BE IMPLEMENTED, BY THE OWNER, FOR THE LIGHT POLES.

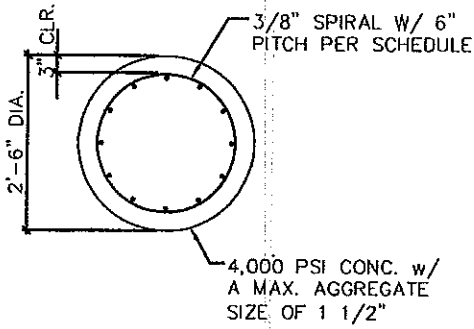

SECTION X-X

LOCATION "A" IS REPRESENTATIVE OF NONCONSTRAINED AREAS.

LOCATION	DIA.	DEPTH BELOW (E) GRADE	VERT. REINF.		SPIRAL	
			NO.	SIZE	SIZE	PITCH
A	30"	10.5 FT	6	6	3/8	6"

BAR SCHEDULE	
BAR SIZE	# OF BARS
#6	(17)
#7	(12)
#8	(9)
#9	(8)

1% MIN. As

THE PIER DEPTH MAY CHANGE AFTER LIGHT POLE MANUFACTURER PROVIDES THE REACTIONS OF THE POLE TO THE FOUNDATION

PROJ. NO. 201401

03/03/14

SOLAR LIGHT POLES
Hidalgo Co. Pct. 2

R ENGINEERING, PLLC

Texas Firm Registration F-12179
3620 Ida
Edinburg, Texas 78539
Phone: (956) 292-3336
rene.olivarez@sbcglobal.net

Light Pole Foundation

DATE: 03/03/14
REVISIONS:
DRAWN BY: R.O.
SHEET No. 2
SHEET NAME: S101

GENERAL NOTES

- THESE CONTRACT STRUCTURAL DRAWINGS AND SPECIFICATIONS REPRESENT THE FINISHED STRUCTURE. UNLESS OTHERWISE INDICATED, THEY DO NOT INDICATE THE METHOD OF CONSTRUCTION. THE CONTRACTOR SHALL PROVIDE ALL MEASURES NECESSARY TO PROTECT THE STRUCTURE, WORKMEN, AND OTHER PERSONS DURING CONSTRUCTION. SUCH MEASURES SHALL INCLUDE, BUT NOT BE LIMITED TO BRACING, SHORING FOR EARTH BANKS, FORMS, SCAFFOLDING, PLANKING, SAFETY NETS, SUPPORT AND BRACING FOR CRANES AND GIN POLES, ETC. THE CONTRACTOR SHALL SUPERVISE AND DIRECT THE WORK AND HE SHALL BE SOLELY RESPONSIBLE FOR ALL CONSTRUCTION MEANS, METHODS, TECHNIQUES, SEQUENCES, AND PROCEDURES. OBSERVATIONS VISITS TO THE SITE BY THE ARCHITECT OR THE ENGINEER DO NOT INCLUDE INSPECTION OF THE ABOVE AND BELOW ITEMS.
- ALL CONSTRUCTION AND QUALITY OF MATERIALS SHALL COMPLY WITH THE GOVERNING BUILDING CODES AND REGULATIONS.
- THE CONTRACTOR SHALL VERIFY ALL DIMENSIONS, ELEVATIONS AND CONDITIONS AT THE JOB SITE BEFORE COMMENCEMENT OF WORK AND SHALL IMMEDIATELY REPORT ANY DISCREPANCIES OR OMISSIONS TO THE ARCHITECT IN WRITING ANY OMISSION OF CONFLICT BETWEEN THE VARIOUS ELEMENTS OF THE WORKING DRAWINGS AND/OR SPECIFICATIONS SHALL BE BROUGHT TO THE ATTENTION OF THE ENGINEER BEFORE PROCEEDING WITH ANY WORK SO INVOLVED.
- IN CASE OF CONFLICT, NOTES AND DETAILS ON THE BALANCE OF THE DRAWINGS TAKE PRECEDENCE OVER STANDARD NOTES AND TYPICAL DETAILS.
- WHERE CONSTRUCTION DETAILS ARE NOT SPECIFICALLY SHOWN OR NOTED FOR ANY PART OF THE WORK SUCH DETAILS SHALL BE CONSTRUCTED IN ACCORDANCE WITH DETAILS SHOW FOR SIMILAR CONDITIONS AND MATERIALS, WHERE SUFFICIENTLY SIMILAR WORK IS NOT SHOWN, THE ENGINEER SHALL BE CONSULTED FOR CLARIFICATION.
- EACH SUBCONTRACTOR IS CONSIDERED AN EXPERT IN HIS RESPECTIVE FIELD AND SHALL PRIOR TO THE SUBMISSION OF BID OR PERFORMANCE OF WORK, NOTIFY THE GENERAL CONTRACTOR OR OWNER OF ANY WORK CALLED OUT ON THE DRAWINGS IN HIS TRADE THAT CANNOT BE GUARANTEED.
- THE CONTRACTOR SHALL COORDINATE ALL MECHANICAL AND ELECTRICAL EQUIPMENT AS TO WEIGHTS AND EXACT LOCATIONS, WITH STRUCTURAL SUPPORTS. IN THE EVENT THAT THE PURCHASED EQUIPMENT DEVIATES IN WEIGHT AND LOCATIONS FROM THOSE INDICATED ON THE PLANS, THE ARCHITECT MUST BE NOTIFIED AND APPROVAL OBTAINED PRIOR TO INSTALLATION.
- THIS STRUCTURE IS DESIGNED AS A STABLE UNIT AFTER ALL COMPONENTS ARE IN PLACE. THE CONTRACTOR SHALL BE RESPONSIBLE TO PROVIDE TEMPORARY BRACING AS REQUIRED TO INSURE THE VERTICAL AND LATERAL STABILITY OF THE ENTIRE STRUCTURE, OR ANY PORTIONS THEREOF, DURING CONSTRUCTION.
- NEITHER THE OWNER NOR THE ARCHITECT NOR THE ENGINEER WILL ENFORCE SAFETY MEASURES OR REGULATIONS. THE CONTRACTOR SHALL DESIGN, CONSTRUCT AND MAINTAIN ALL SAFETY DEVICES, INCLUDING SHORING AND BRACING AND SHALL BE SOLELY RESPONSIBLE FOR CONFORMING TO ALL LOCAL STATE AND FEDERAL SAFETY AND HEALTH STANDARDS, LAWS AND REGULATIONS.
- TRADE NAMES AND MANUFACTURERS REFERRED TO ARE FOR QUALITY STANDARDS ONLY. SUBSTITUTIONS WILL BE PERMITTED AS APPROVED BY THE ENGINEER.
- ANY OPTIONS OR APPROVED SUBSTITUTIONS ARE FOR CONTRACTORS CONVENIENCE. THE CONTRACTOR SHALL BE RESPONSIBLE FOR ALL CHANGES, ADDITIONAL COSTS AND COORDINATION WITH ALL ITEMS THAT THE SUBSTITUTIONS MAY IMPACT.
- THE ENGINEER IS TO BE NOTIFIED IN WRITING WHEN CONSTRUCTION AT THE SITE BEGINS.
- ANY QUESTIONS RELATED TO INTERPRETATION OR INTENT OF THESE DRAWINGS SHALL BE REFERRED TO THE ENGINEER.
- THE CONTRACTOR SHALL TAKE ALL NECESSARY PRECAUTIONS TO LOCATE AND PROTECT ANY EXISTING UNDERGROUND OR CONCEALED CONDUIT, PLUMBING, OR OTHER UTILITIES PRIOR TO BEGINNING ANY WORK.
- PIPES, DUCTS, SLEEVES, CHASES, ETC. SHALL NOT BE PLACED IN BEAMS OR WALLS UNLESS SPECIFICALLY SHOWN OR NOTED. NOR SHALL ANY STRUCTURAL MEMBER BE CUT FOR PIPES, DUCTS, ETC. UNLESS NOTED CONTRACTOR SHALL OBTAIN PRIOR APPROVAL FOR INSTALLATION OF ANY ADDITIONAL PIPES DUCT, ETC.

CONTACTS

CITY OF ALAMO PUBLIC WORKS 956-787-8321
 CENTRAL POWER & LIGHT 800-245-4545
 S.W. BELL TELEPHONE CO. 800-828-5127
 SOUTHERN UNION GAS 956-444-3926
 HERITAGE CABLEVISION 956-787-9494
 DIG TESS 800-DIG-TESS
 TEXAS ONE CALL 800-545-6005
 AEP 877-373-4858

CAST-IN-PLACE CONCRETE

VERIFY ALL DIMENSIONS. COORDINATE WITH ARCHITECTURAL PLANS PRIOR TO CONSTRUCTION AND NOTIFY ARCHITECT AND/OR ENGINEER OF ANY DISCREPANCIES.

- ALL CONCRETE WORK SHALL BE IN ACCORDANCE WITH THE AMERICAN CONCRETE INSTITUTE SPECIFICATIONS, ACI #301-98, OR LATEST EDITION. DRILLED PIERS SHALL COMPLY WITH ACE 336.1-98 AND ACI 336.3R-93
- ALL DETAILING, FABRICATION AND ERECTION OF REINFORCING BARS, AND ALL ACCESSORIES UNLESS OTHERWISE NOTED, SHALL BE IN ACCORDANCE WITH THE ACI MANUAL OF STANDARD PRACTICE FOR DETAILING REINFORCED CONCRETE. ACI #315 LATEST EDITION.
- THE MINIMUM 28 DAYS CYLINDER STRENGTH SHALL BE AS FOLLOWS:

LOCATION	STRENGTH	MAXIMUM SLUMP	MAXIMUM AGGREGATE
PIERS	4000 PSI	5"	1 1/2"

- PORTLAND CEMENT SHALL CONFORM TO A.S.T.M. C150-97A, TYPE I OR II. STRUCTURAL CONCRETE AGGREGATE SHALL CONFORM TO ASTM C 33-97, STANDARD WEIGHT.
- ALL CONCRETE SHALL CONTAIN "POZZOLITA" ADJUX AS PER MANUFACTURERS SPECIFICATIONS, IN ACCORDANCE WITH ASTM C494, NO CALCIUM CHLORIDE AS CEMENT REPLACEMENT WILL BE PERMITTED IN CONCRETE.
- REQUIREMENTS FOR COLD AND HOT WEATHER SHALL BE PER IBC SECTIONS 1905.12 AND 1905.13
- CONCRETE COVER FOR REINFORCING AS FOLLOWS:
 - DRILLED PIERS, FOOTINGS AND OTHER PRINCIPAL STRUCTURAL MEMBER IN WHICH CONCRETE IS DEPOSITED AGAINST GROUND:
 - ANCHOR BOLTS, DOVELS, INSERTS, ETC. SHALL BE SECURELY TIED IN PLACE PRIOR TO PLACING CONCRETE.
 - MECHANICALLY VIBRATE ALL CONCRETE WHEN PLACED.
- READY MIX CONCRETE SHALL COMPLY WITH REQUIREMENTS OF ASTM C94 WHEN AIR TEMPERATURE IS BETWEEN 85° AND 90°F, REDUCE MIXING AND DELIVERY TIME FROM 90 MINUTES TO 75 MINUTES; WHEN AIR TEMPERATURE IS ABOVE 90°F REDUCE MIXING AND DELIVERY TIME TO 60 MINUTES.

STRAIGHT SHAFT PIERS

- CONCRETE PIERS SHALL BE PER SCHEDULE OR DETAIL.
- ALL REINFORCING BARS SHALL BE NEW BILLET STEEL AND SHALL CONFORM TO ASTM A-615, GRADE 60
- ALL REINFORCING STEEL SHALL BE CONTINUOUS WITH SPLICES LAPPED 75 BAR DIAMETERS
- CENTER FOOTING UNDER COLUMN OR WALL UNLESS DIMENSIONED OTHER WISE
- PIERS SHAFT SHALL BE DRILLED PLUMB ALONG ITS TOTAL LENGTH (1" PER 10' MAXIMUM TOLERANCE)
- BOTTOM OF PIER TO BE CLEAN AND FREE OF ALL LOOSE MATERIALS AND WATER
- CENTER STEEL CAGE IN SHAFT WITH A MINIMUM 3 LEVELS OF CONCRETE BLOCK SPACERS (8FT. MAXIMUM SPACING) AT A MINIMUM OF 3' EVELY ON 3' CONCRETE SEAT BLOCK.
- DO NOT RAISE CAGE OFF OF FOOTING BOTTOM DURING CONCRETE PLACEMENT.
- CONCRETE AND REINFORCING IN SHAFTS SHALL BE PLACED THE SAME DAY AS DRILLING.
- PIERS SHALL BE FOUNDED IN UNDISTURBED NATURAL SOIL.
- CONTRACTOR SHALL COORDINATE WITH GEOTECHNICAL ENGINEER FOR VERIFICATION OF PIERS BEARING STRATUM AT TIME OF DRILLING.
- ALL DRILLED FOOTINGS SHALL BE FREE OF WATER PRIOR TO POURING OF CONCRETE.
- FOOTING HOLES SHALL NOT BE LEFT OPEN OVERNIGHT (NO EXCEPTIONS).
- PROVIDE STEEL CASING AS REQUIRED TO PREVENT CAVE-IN
- STEEL CASING SHALL BE REMOVED DURING POURING SEQUENCE

DESIGN CRITERIA

- DESIGN LOADS, STRUCTURAL ANALYSIS AND PREPARATIONS OF STRUCTURAL MEMBERS IS BASED UPON THE FOLLOWING CRITERIA:

CODE:	IBC 2003
WIND SPEED (3 SECOND GUST)	110

CONSTRUCTION NOTES

- THE CONTRACTOR SHALL CALL 1-800-DIGTESS PRIOR TO ANY EXCAVATION OR DIGGING.
- THE CONTRACTOR SHALL BE RESPONSIBLE FOR LOCATING AND IDENTIFYING ALL UNDERGROUND UTILITIES PRIOR TO STARTING ANY WORK.
- ALL ELECTRICAL WIRING AND CONDUIT SHALL BE CONCEALED AS TO PREVENT VANDALISM.
- THE CONTRACTOR SHALL BRING TO THE ATTENTION OF THE CIVIL ENGINEER ANY CONFLICT AT THE SITE PRIOR TO INSTALLATION.

PROJ. NO. 201401

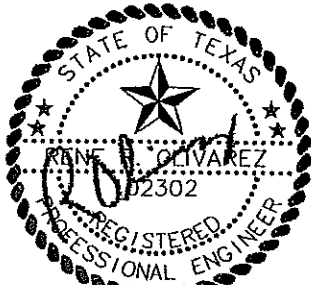

03/03/14

SOLAR LIGHT POLES
Hidalgo Co. Pct. 2



ENGINEERING, PLLC

Texas Firm Registration F-12179
 3620 Ida
 Edinburg, Texas 78539
 Phone: (956) 292-3336
 rene.olivarez@sbcglobal.net

Light Pole Foundation

DATE: 03/03/14
 REVISIONS:
 DRAWN BY: R.O.

SHEET No.

1

SHEET NAME:

S102



February 25, 2014

Buy Board / Facility Solutions Group

PO Box 400

Austin TX, 78767-0400

Here are the published list prices for the following solar lighting systems:

TPN-1TF2E45-Q3H-3D-10 **System Description:** 45W 2020 LED fixture system. System run time is dusk to dawn (DTD) with 10 ft. Universal Arm, includes wooden pole adapter kit. No powder coating on system. 2020 fixture only will be powder coated in gray. Includes 37' Direct burial ANSI5.1 Wooden Pole \$7825

TPN-1TF2E45-Q3H-3D **System Description:** 45W 2020 LED fixture system run time is dusk to dawn (DTD) no arm, includes wooden pole adapter kit. No powder coating on system. 2020 fixture only will be powder coated in gray. Includes 37' Direct burial ANSI5.1 Wooden Pole \$7491.66

TPN-1TF2E60-Q4H-3D-10 **System Description:** 60W 2020 LED fixture system running dusk to dawn (DTD) with 10 ft. Universal Arm, includes wooden pole adapter kit. No powder coating on system. 2020 fixture only will be powder coated in gray. Includes 37' Direct burial ANSI5.1 Wooden Pole \$8325

TPN-1TF2E60-Q4H-3D **System Description:** 60W 2020 LED fixture system run time is dusk to dawn (DTD) no arm, includes wooden pole adapter kit. No powder coating on system. 2020 fixture only will be powder coated in gray. Includes 37' Direct burial ANSI5.1 Wooden Pole \$7991.67



*

TPN-1TF2E60-Q4H-3D-P25-10 **System Description:** 60W 2020 LED fixture system running dusk to dawn (DTD) with 10 ft. Universal Arm, includes wooden pole adapter kit. No powder coating on system. 2020 fixture only will be powder coated in gray. Includes 25' Aluminum Bolt down pole \$8507

Sincerely,

Vickie Self
Central Regional Manager, Sol Inc.

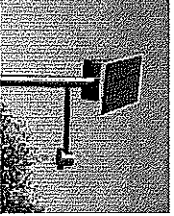
Texas Buy Board Catalog

Product	Buy Board Model Number	Description	List Price
Solar Pathway Lighting GreenWay Ascot with Direct Embedded Pole			
	GWZ-1GAZE20-G1H-P24	20W LED ascot pathway light, type 2 distribution, operating at full for 6 hours after dusk, dimming to 50%, then operating at full 2 before dawn, locking battery box, and a 24 ft direct burial straight aluminum pole. May be able to have DTD in some zip codes. Bronze Powder Coating.	\$ 4,587.00
	GWZ-1GASE20-G1H-P24	20W LED ascot pathway light, type 5 distribution, operating at full for 6 hours after dusk, dimming to 50%, then operating at full 2 before dawn, locking battery box, and a 24 ft direct burial straight aluminum pole. May be able to have DTD in some zip codes. Bronze Powder Coating.	\$ 4,587.00
GreenWay Ascot without Direct Embedded Pole			
	GWZ-1GASE20-G1H w/o pole	20W LED ascot pathway light, type 5 distribution, operating at full for 6 hours after dusk, dimming to 50%, then operating at full 2 before dawn, locking battery box. May be able to have DTD in some zip codes. Bronze Powder Coating.	\$ 3,729.00
GreenWay Shoebox with Direct Embedded Pole			
	GWZ-1SSZE20-G1H-P24	20W LED shoebox pathway light, type 2 distribution, operating at full for 6 hours after dusk, dimming to 50%, then operating at full 2 before dawn, locking battery box, and a 24 ft direct burial straight aluminum pole. May be able to have DTD in some zip codes. Bronze Powder Coating.	\$ 4,620.00
	GWZ-1SSSE20-G1H-P24	20W LED shoebox pathway light, type 5 distribution, operating at full for 6 hours after dusk, dimming to 50%, then operating at full 2 before dawn, locking battery box. May be able to have DTD in some zip codes. Bronze Powder Coating.	\$ 3,796.32
GreenWay Shoebox without Direct Embedded Pole			
	GWZ-1XFE20-G1H-P24	20W LED 1010 pathway light, type 2 distribution, operating at full for 6 hours after dusk, dimming to 50%, then operating at full 2 before dawn, locking battery box, and a 24 ft direct burial straight aluminum pole. May be able to have DTD in some zip codes. Bronze Powder Coating.	\$ 4,587.00



GWZ-1XP2E25-G1H-P24

25W LED 1010 pathway light, type 2 distribution, operating at full for 6 hours after dusk, dimming to 50%, then operating at full 2 before dawn, locking battery box, and a 24 ft direct burial straight aluminum pole. May be able to have DTD in some zip codes. Bronze Powder Coating. \$ 4,719.00

Option: Deduct \$200/system for no powder coating

Solar Pathway, Area, and Parking Lot Lights
TP Series Cobra Head with 10 ft Arm (pole included)

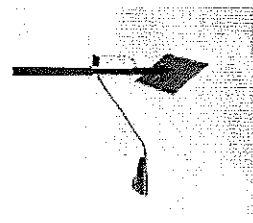

SPM-300-3Q-CH-DOME-10'Arm-DTD w/37" Direct Burial-ANS15, 1-WOODPOLE, Includes wooden pole adapter kit

TPN-1CD2E45-Q3H-3D-10 45W LED Cobra Head Fixture, Type 2 distribution, operating at full for 6 hours after dusk, dimming to 50%, then operating at full 2 hrs before dawn, locking battery box. May run DTD in some zip code locations. With 37" direct burial-ANS15, 1-Woodpole. No finish. \$ 5,742.00

SPM-300-3Q-CH-DOME-10'ARM-DTD w/25'boltdown-STEEL

TPN-1CD2E45-Q3H-3D-10 45W LED Cobra Head Fixture, Type 2 distribution, operating at full Dusk to dawn (DTD). May need to reduce to 6 hours after dusk, dimming to 50%, then operating at full 2 hrs before dawn in some zip code locations, locking battery box. With 25' Steel bolt down pole. No finish. \$ 7,504.20

SPM-300-3Q-CH-DOME-10'ARM-DTD w/25'boltdown-ALUMINUM

TPN-1CD2E45-Q3H-3D-10 45W LED Cobra Head Fixture, Type 2 distribution, operating at full Dusk to dawn (DTD). May need to reduce to 6 hours after dusk, dimming to 50%, then operating at full 2 hrs before dawn in some zip code locations, locking battery box. With 25' Aluminum bolt down pole. No finish. \$ 7,227.00

TPM-1CD2A60-Q4H-3K-P25 Aluminum

TPN-1CD2E60-Q4H-3K-10-P25 60W LED Cobrahead Fixtures Type 2 distribution, operating at full Dusk to dawn (DTD). May need to reduce to 6 hours after dusk, dimming to 50%, then operating at full 2 hrs before dawn in some zip code locations, locking battery box. With 25' Aluminum bolt down pole. No finish. \$ 8,573.40

TP Series Dual Cobra Head with 6 ft Arm

TPM-375-3Q-2CH-DOME-6'ARM-0440002 (pole not included)

TPM-2CD2E45-Q4H-3K-6 Dual 45W Cobra head fixtures, Type 2 distribution, operating at full for 4 hours after dusk, dimming to 40%, then operating at full 2 hrs. before dawn, locking battery box. Powder coating in Bronze or Black. \$ 6,270.00

TPM-375-3Q-2CH-DOME-6'ARM-0440002 w/ a 25ft. Fiberglass bolt down pole

TPM-2CD2E45-Q4H-3K-6 Dual 45W Cobra head fixtures, Type 2 distribution, operating at full for 4 hours after dusk, dimming to 40%, then operating at full 2 hrs. before dawn, locking battery box. Powder coating in Bronze or Black. 25 ft. Fiberglass bolt down pole included. \$ 8,250.00

TPM-375-3Q-2CH-DOME-6-ARM-0440002 w/
a 25ft. Aluminum bolt down pole
TPM-2CD2F45-Q4H-3K-6 Dual 45W Cobra head
fixtures, Type 2 distribution, operating at full for 4 hours
after dusk, dimming to 40%, then operating at full 2 hrs.
before dawn, locking battery box. Powder coating in
Bronze or Black, 25 ft. Aluminum bolt down pole
included. \$ 8,910.00

Solar Pathway, Area, and Parking Lot Lights
10/10 SERIES with 20ft Channelled Aluminum Pole w/ Anchor Bolts

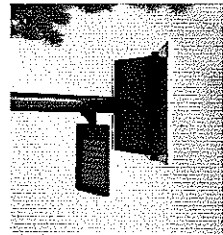

TTZ-1TF(X)E20-TXS-xx-P20 Controller DTD
20w LED 10/10 Fixture, type 2, type 3, or type 5
distribution (Specify T2, T3, or T5), operating dusk until
dawn, locking battery box. 20 ft Channelled Pole
included. \$ 8,250.00

TTZ-1TF(X)E20-TXS-xx-P20 Controller 065002
20w LED 10/10 Fixture, type 2, type 3, or type 5
distribution (Specify T2, T3, or T5) operating at full for 6
hours after dusk, dimming to 50%, then operating at
full 2 before dawn, locking battery box. 20 ft Channelled
Pole included. \$ 8,250.00

TTZ-1TF(X)E30-TXS-xx-P20 Controller DTD
30w LED 10/10 Fixture, type 2, type 3, or type 5
distribution (Specify T2, T3, or T5), operating dusk until
dawn, locking battery box. 20 ft Channelled Pole
included. \$ 8,514.00

TTZ-1TF(X)E30-TXS-xx-P20 Controller 065002
30w LED 10/10 Fixture, type 2, type 3, or type 5
distribution (Specify T2, T3, or T5) operating at full for 6
hours after dusk, dimming to 50%, then operating at
full 2 before dawn, locking battery box. 20 ft Channelled
Pole included. \$ 8,250.00

TTZ-1TF(X)E40-TXS-xx-P20 Controller DTD
40w LED 10/10 Fixture, type 2, type 3, or type 5
distribution (Specify T2, T3, or T5), operating dusk until
dawn, locking battery box. 20 ft Channelled Pole
included. \$ 9,570.00

TTZ-1TF(X)E40-TXS-xx-P20 Controller 065002
40w LED 10/10 Fixture, type 2, type 3, or type 5
distribution (Specify T2, T3, or T5) operating at full for 6
hours after dusk, dimming to 50%, then operating at
full 2 before dawn, locking battery box. 20 ft Channelled
Pole included. \$ 8,514.00

(X) = Must specify Type 2, 3 or 5 Light distribution
x = qty. of batteries to be determined by Sol Inc. based on zip code location of installation
xx= qty. and size of PV Panels to be determined by Sol Inc. based on zip code location of installation

Solar Pathway, Area, and Parking Lot Lights
20/20 SERIES with 20ft Channelled Aluminum Pole w/ Anchor Bolts



TTZ-1TF(X)E40-TXS-xx-P20 Controller DTD
40w LED 20/20 Fixture, type 2, type 3, or type 5
distribution (Specify T2, T3, or T5), operating dusk until
dawn, locking battery box. 20 ft Channelled Pole
included. \$ 9,834.00

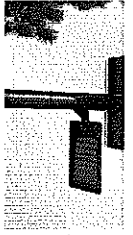

TTZ-1TF(X)E40-1XS-xx-P20 Controller 065002

40w LED 20/20 Fixture, type 2, type 3, or type 5 distribution (specify T2, T3, or T5) operating at full for 6 hours after dusk, dimming to 50%, then operating at full 2 before dawn, locking battery box. 20 ft Channelled Pole included. \$ 8,778.00

TTZ-1TF(X)E50-1XS-xx-P20 Controller DTD

50w LED 20/20 Fixture, type 2, type 3, or type 5 distribution (specify T2, T3, or T5), operating dusk until dawn, locking battery box. 20 ft Channelled Pole included. \$ 10,362.00

TTZ-1TF(X)E50-1XS-xx-P20 Controller 065002

50w LED 20/20 Fixture, type 2, type 3, or type 5 distribution (specify T2, T3, or T5) operating at full for 6 hours after dusk, dimming to 50%, then operating at full 2 before dawn, locking battery box. 20 ft Channelled Pole included. \$ 9,174.00

TTZ-1TF(X)E60-1XS-xx-P20 Controller DTD

60w LED 20/20 Fixture, type 2, type 3, or type 5 distribution (specify T2, T3, or T5), operating dusk until dawn, locking battery box. 20 ft Channelled Pole included. \$ 10,540.20

TTZ-1TF(X)E60-1XS-xx-P20 Controller 065002

60w LED 20/20 Fixture, type 2, type 3, or type 5 distribution (specify T2, T3, or T5) operating at full for 6 hours after dusk, dimming to 50%, then operating at full 2 before dawn, locking battery box. 20 ft Channelled Pole included. \$ 9,966.00

TTZ-1TF(X)E70-1XS-xx-P20 Controller DTD

70w LED 20/20 Fixture, type 2, type 3, or type 5 distribution (specify T2, T3, or T5), operating dusk until dawn, locking battery box. 20 ft Channelled Pole included. \$ 10,738.20

TTZ-1TF(X)E70-1XS-xx-P20 Controller 065002

70w LED 20/20 Fixture, type 2, type 3, or type 5 distribution (specify T2, T3, or T5) operating at full for 6 hours after dusk, dimming to 50%, then operating at full 2 before dawn, locking battery box. 20 ft Channelled Pole included. \$ 10,362.00

(X) = Must specify Type 2, 3 or 5 Light distribution Example: TTZ-1TF2E40-1XS-2D-P20
 x = qty. of batteries to be determined by Sol Inc. based on zip code location of installation
 xx= qty. and size of PV Panels to be determined by Sol Inc. based on zip code location of installation

Sign, Monument Lighting
BLS Series Sign Lighting



BUN-1FSE20-xxx-xx-P12

Fits up to 6'x10' sign, Single Sided, Dusk to Dawn system w/ 20W LED Mini Flood, locking battery box, 12 ft aluminum embedded pole \$ 3,282.84

BUN-2FSE20-xxx-xx-P12

Fits up to 8'x12' sign, single sided, Dusk to Dawn system with (2)20W Mini Flood fixtures, locking battery box, 12 ft aluminum embedded pole \$ 4,730.88

BUN-3FSE20-xxx-xx-P12

Fits up to 12'x16' sign, single sided, Dusk to Dawn system with (3)20W Mini Flood fixtures, locking battery box, 12 ft aluminum embedded pole \$ 5,272.08

BLS Options

BLS Ground Spike

Option for ground spike (Each) \$ 33.00

BLS 4' mounting arm (Each)

Option for 4' mounting arm (Each) \$ 77.88

BLS Powder Coat Adder (per system)

Powder Coat Adder (per system) \$ 462.00

Oasis Shelter Lighting
6W Oasis Remote Luminaire



OAC-10R5A06-B

OAC-10R5A06-D



OAC-10R5A06-K

Shelter Lighting for 15x15' shelters, Dusk to Dawn system with 6W LED Oasis fixture, 90W PV panel, locking battery box	\$ 2,065.80
Shelter Lighting for 15x15' shelters, Dusk to Dawn system with 6W LED Oasis fixture, 125W PV panel, locking battery box	\$ 2,183.28
Shelter Lighting for 15x15' shelters, Dusk to Dawn system with 6W LED Oasis fixture, 135W PV panel (UL listed), locking battery box	\$ 2,638.68



BLS Systems - Solar Sign Lighting Systems -

P/N	Buy Board Part Number	List	Buy Board Price	
BLS-P2	SSS-BB-P2-(color)	15W LED flood light for a 6'H X 10'W sign, configured for dusk until dawn operation at full light output	\$4,006	\$2,484
BLS-P6	SSS-BB-P6-(Color)	15W LED flood light for a 6'H X 10'W sign, configured for 6 hours after dusk, turning of, then operating 2 hours before dawn	\$3,691	\$2,288
BLS-P10	SSS-BB-P10-(Color)	2-15W LED flood lights for a 8'H X 12'W sign, configured for 6 hours after dusk, turning of, then operating 2 hours before dawn	\$5,916	\$3,668
BLS-P15	SSS-BB-15-(Color)	2-15W LED flood lights for a 8'H X 12'W sign, configured for 6 hours after dusk, turning of, then operating 2 hours before dawn	\$5,434	\$3,369
BLS-P20	SSS-BB-P20-(Color)	45W LED flood lights for a 12'H X 16'W sign, configured for 6 hours after dusk, turning of, then operating 2 hours before dawn	\$8,531	\$5,289
BLS-P23	SSS-BB-P23-(Color)	45W LED flood lights for a 12'H X 16'W sign, configured for 6 hours after dusk, turning of, then operating 2 hours before dawn	\$6,120	\$3,794

Color Options: Bronze -B, Black-K

Note on all the above:

Batteries, Photovoltaic Panels, and hours of operation will vary based on hours of sun and weather conditions in your area.



February 25, 2014

Buy Board / Facility Solutions Group

PO Box 400

Austin TX, 78767-0400

Here are the published list prices for the following solar lighting systems:

TPN-1TF2E45-Q3H-3D-10 **System Description:** 45W 2020 LED fixture system. System run time is dusk to dawn (DTD) with 10 ft. Universal Arm, includes wooden pole adapter kit. No powder coating on system. 2020 fixture only will be powder coated in gray. Includes 37' Direct burial ANSI5.1 Wooden Pole \$7825

TPN-1TF2E45-Q3H-3D **System Description:** 45W 2020 LED fixture system run time is dusk to dawn (DTD) no arm, includes wooden pole adapter kit. No powder coating on system. 2020 fixture only will be powder coated in gray. Includes 37' Direct burial ANSI5.1 Wooden Pole \$7491.66

TPN-1TF2E60-Q4H-3D-10 **System Description:** 60W 2020 LED fixture system running dusk to dawn (DTD) with 10 ft. Universal Arm, includes wooden pole adapter kit. No powder coating on system. 2020 fixture only will be powder coated in gray. Includes 37' Direct burial ANSI5.1 Wooden Pole \$8325

TPN-1TF2E60-Q4H-3D **System Description:** 60W 2020 LED fixture system run time is dusk to dawn (DTD) no arm, includes wooden pole adapter kit. No powder coating on system. 2020 fixture only will be powder coated in gray. Includes 37' Direct burial ANSI5.1 Wooden Pole \$7991.67

TPN-1TF2E60-Q4H-3D-P25-10 **System Description:** 60W 2020 LED fixture system running dusk to dawn (DTD) with 10 ft. Universal Arm, includes wooden pole adapter kit. No powder coating on system. 2020 fixture only will be powder coated in gray. Includes 25' Aluminum Bolt down pole \$8507

Sincerely,

Vickie Self
Central Regional Manager, Sol Inc.



Search Results

Search:

Show results

Narrow Results:

- All
- Vendor Discounts Only
- Catalog Pricing Only

Refine Your Search:

- Vendors
- Facility Solutions Group[X]
- Price Range
- Show all prices
- Category
- None Selected
- Contract
- None selected

Additional Searches:

[Search by Vendor](#)

[Browse Contracts](#)

[Instructional Materials](#)

Additional Resources

Vendor	Description	Pricing
Facility Solutions Group	50% Discount Off GE pricelist for Electronic HPS Ballasts, Lamps, and Fixtures	Pricing
Facility Solutions Group	50% Discount Off GE pricelist for Electronic HID Ballasts, Lamps, and Fixtures	Pricing
Facility Solutions Group	25% Discount Off Philips pricelist for LED Tube Lighting Products	Pricing
Facility Solutions Group	20% Discount Off TCP pricelist for Exit Polycarbonate Products	Pricing
Facility Solutions Group	20% Discount Off SensorSwitch pricelist for All Other Products	Pricing
Facility Solutions Group	20% Discount Off RAB Lighting pricelist for All Other Products	Pricing
Facility Solutions Group	20% Discount Off Lutron pricelist for Ceiling and Wall Box Motion Sensors	Pricing
Facility Solutions Group	20% Discount Off Lithonia Lighting pricelist for All Other Products	Pricing
Facility Solutions Group	20% Discount Off Cooper pricelist for All Other Products	
Facility Solutions Group	18% Discount Off WattStopper pricelist for Watt Stopper Sensors	Pricing
Facility Solutions Group	15% Discount Off % Adder for 110 MPH wind speed for % Adder for 110 MPH wind speed	
Facility Solutions Group	10% Discount Off Sol Solar Lighting pricelist for All Other Parks & Recreation Equipment/Products	Pricing
Facility Solutions Group	10% Discount Off SOL Outdoor Lighting pricelist for Solar Lighting Products	Pricing

Extended Product Information

Reference Number: 437-13

Part Number: Catalog

Vendor Website: <http://www.fsgconnect.com>

Full Description: 10% Discount Off of SOL Outdoor Lighting pricelist for Solar Lighting Products

Facility Solutions Group	0% Discount Off FSG pricelist for Recycle of Lamps, Batteries and Ballasts
Facility Solutions Group	60' Base Path Baseball / Softball Field, 300' Field Size, 6 Poles, 50/30 fc Light Intensity Field Lighting
Facility Solutions Group	90' Base Path Baseball / Softball Field, 330/400/330 Field Size, 8 Poles, 50/30 fc Light Intensity Field Lighting
Facility Solutions Group	90' Base Path Baseball / Softball Field, 320/360/320 Field Size, 6 Poles, 50/30 fc Light Intensity Field Lighting
Facility Solutions Group	60' Base Path Baseball / Softball Field, 225' Field Size, 6 Poles, 50/30 fc Light Intensity Field Lighting
Facility Solutions Group	60' Base Path Baseball / Softball Field, 200' Field Size, 4 Poles, 50/30 fc Light Intensity Field Lighting



[Administration](#)

[RFQ](#)

[Reports](#)

[Shopping Cart](#)

[Help](#)

Vendor Contract Information

[Proposal Document](#)

[Back](#)

Search:

- All
- Vendor Discounts Only
- Catalog Pricing Only

Refine Your Search:

Vendors

Facility Solutions Group[X]

Price Range

Show all prices

Category

None Selected

Contract

None selected

Additional Searches:

[Search by Vendor](#)

[Browse Contracts](#)

[Instructional Materials](#)

Additional Resources

Vendor Name: Facility Solutions Group

Address: 610 West Powell Lane

Austin, TX 78753

Phone Number: (512) 835-4971

Email: mikeh@fsgi.com

Website: <http://www.fsqconnect.com>

Federal ID: 74-2942838

Contact: Mike Heins

Accepts RFQs: Yes

Minority Owned Vendor: No

Women Owned Vendor: No

Contract Name: Energy Saving Lighting Products

Contract#: 437-13

Effective Date: 04/01/2014

Expiration Date: 03/31/2017

Payment Terms: Net 30 days

Delivery Days: 10

Shipping Terms: Pre-paid and added to invoice

Freight Terms: FOB Destination

Ship Via: Common Carrier

Region Served: All Texas Regions

States Served: Arizona, California, Colorado, Florida, Illinois, Indiana, Kansas, Louisiana, Maryland, Massachusetts, Missouri, New Mexico, New York, Oklahoma, Pennsylvania, Texas

Quote Reference Number: 437-13

Return Policy: 30 days provided electronics have not been installed. All returns are subject to manufacturer restocking fee.

Additional Dealers: Facility Solutions Group in: Indianapolis IN, San Antonio TX, Shawnee OK, Placentia CA, Amboy NJ, Denver CO, Albuquerque NM, Phoenix AZ, El Paso TX, New York NY, Woburn MA, Dallas TX, Houston TX, Ft. Worth TX, Bensenville IL

Regulatory Notice: [Click to view Bonding Regulatory Notice](#)

Construction Services Advisory: [Click to view the Construction Related Goods and Services Advisory](#)

Contact us 800-695-2919



[Administration](#) | [RFQ](#) | [Reports](#) | [Shopping Cart](#) | [Help](#)

Search Results

Search:

labor

Show results

Narrow Results:

- All
- Vendor Discounts Only
- Catalog Pricing Only

Refine Your Search:

- [Vendors](#)
- Facility Solutions Group[X]
- [Price Range](#)
- Show all prices
- [Category](#)
- None Selected
- [Contract](#)
- None selected

Additional Searches:

- [Search by Vendor](#)
- [Browse Contracts](#)
- [Instructional Materials](#)

Additional Resources

Vendor	Description	Pri
Facility Solutions Group	Hourly Labor Rate for Installation/Service of Electronic HID and HPS Ballasts, Lamps, and Fixtures	
Facility Solutions Group	Hourly Labor Rate for Installation/Service of Electronic Ballasts, Fluorescent Lamps, and Fixtures	
Facility Solutions Group	Hourly Labor Rate for Installation/Service of Ceiling and Wall Box Motion Sensors	
Facility Solutions Group	Hourly Labor Rate for Installation/Service of All Other Energy Saving Lighting Products	

Extended Product Information

Reference Number: 437-13
 Part Number: Installation
 Unit Measure: EA
 Vendor Website: <http://www.fsgconnect.com>
 Full Description: Hourly Labor Rate for Installation/Service of All Other Energy Saving Lighting Products

Facility Solutions Group	0% Discount Off FSG Lighting for All Equipment
Facility Solutions Group	70% Discount Off Trade Service Pricing for All Supplies and Materials
Facility Solutions Group	Hourly Labor Rate for All Labor & Installation Services
Facility Solutions Group	Electrical Labor, Unskilled hourly labor rate.
Facility Solutions Group	Electrical Labor, Skilled hourly labor rate.
Facility Solutions Group	All Other Electrical Labor hourly rate.
Facility Solutions Group	Hourly Labor Rate for Installation/Service of Solar Lighting Products
Facility Solutions Group	Hourly Labor Rate for Installation/Service of Exit Polycarbonate Products
Facility Solutions Group	0% Discount Off FSG Electric Pricelist for All Repair Labor
Facility Solutions Group	0% Discount Off FSG Electric Pricelist for All Installation Labor

Showing 1 to 14 of 14 entries

Contact us 800-695-2919