

CONSTRUCTION LOAN AGREEMENT

OWNER-OCCUPIED REHABILITATION LOAN PROGRAM

This Construction Loan Agreement (this "Agreement"), is entered into effective as **March 21, 2017**, among Borrower, Lender and Contractor who are identified and whose addresses are stated below. This Agreement relates to the manner of disbursement of the loan proceeds on the Note for the benefit of Borrower for the rehabilitation and/or renovation of the Improvements on the Property under the Lender's Owner-Occupied Housing Rehabilitation Program. The Note is secured by liens on the Property and Improvements granted the Mechanic's Lien Contract and the Deed of Trust.

BORROWER: Arturo & Oralia C. Ramirez

BORROWER'S ADDRESS:

**13521 Collin Dr.,
Edinburg, Texas 78542**

LENDER: County of Hidalgo, a political subdivision of the State of Texas

LENDER'S ADDRESS:

County of Hidalgo, Urban County Program
Owner-Occupied Rehabilitation Loan Program
427 E. Duranta Ave., Suite 107
Alamo, Texas 78516

CONTRACTOR: R G Enterprises, LLC, G & G Contractors

CONTRACTOR'S ADDRESS:

**711 E. Wisconsin Rd
Edinburg, Texas 78539**

NOTE:

Mechanic's Lien Note ("Mechanic's Lien Note") of even date herewith, in the original principal amount of **\$59,740.00**, executed by Borrower, and payable to the order of Contractor, which note has been renewed and extended into a Promissory Note of even date herewith, in the original principal amount of **\$59,740.00**, executed by Borrower, and payable to Lender.

CONTRACT:

Mechanic's Lien Contract and Transfer of Lien of even date herewith, executed by Borrower and Contractor providing for the rehabilitation and/or renovation to the Improvements and (i) granting Contractor liens against the Property to secure payment of the Mechanic's Lien Note; and (ii) transferring such liens to Lender.

SECURITY FOR PAYMENT:

Mechanic's and materialman's lien on the Property granted by Borrower to Contractor in the Mechanic's Lien Contract and Transfer of Lien (the "Mechanic's Lien Contract"), which liens were transferred thereunder to Lender, which Mechanic's Lien Contract and Transfer of Lien is recorded in the Real Property Records of Hidalgo County, Texas, and a deed of trust lien on the Property granted by Borrower for the benefit of Lender in a Deed of Trust ("Deed of Trust") of even date herewith, which Deed of Trust is recorded in the Real Property Records of Hidalgo County, Texas

PROPERTY: See Exhibit "A" attached hereto and made a part hereof for all purposes

IMPROVEMENTS:

Renovation and/or rehabilitation to Borrower's residence located on the Property according to: (i) Plans and Specifications, Timetable and Budget attached hereto as Exhibit "B"; (ii) an Owner-Occupied Rehabilitation Loan Program Contract (the "Rehabilitation Contract") of even date herewith entered into by and between Borrower and Lender; and (iii) the accepted bid submitted to Lender by Contractor.

AMOUNT AVAILABLE FOR CONSTRUCTION: **\$59,740.00**

For good and valuable consideration, the receipt and sufficiency of which are hereby acknowledged, Borrower, Lender and Contractor agree as follows:

1. Purpose and Limitation of Advances.

(a) Subject to the provisions of this Agreement, and in compliance with Subchapter K, Chapter 53, Texas Property Code, Lender will advance funds to Contractor for the benefit of Borrower in the aggregate amount of the Note. Provided Contractor has obtained the performance bond required in Paragraph 1 (b) of this Agreement, Lender will advance the Amount Available for Construction during the course of the construction of the Improvements, in accordance with this Agreement. The Amount Available for Construction will be advanced solely to pay Contractor for costs of labor performed and materials furnished by Contractor pursuant to the Contract.

(b) Contractor may furnish a performance bond ("Bond"), at Contractor's sole cost and expense, to be kept in force throughout the period of this Agreement, in an amount equal to the Amount Available for Construction. The Bond shall: (i) cover Contractor's faithful performance of the Contract, free of liens upon the Property; (ii) name as obligees both Borrower and Lender, jointly and severally; (iii) be written by surety companies qualified to do business in the State of Texas; and (iv) be in such form and with such sureties as the Lender may approve.

(c) Construction advances are to be made by Lender to Borrower for work done.

(d) If Contractor has provided Lender and Borrower the Bond permitted by this Agreement, Contractor may submit a request for 40% of the Amount Available for Construction ("Initial Advance") when 50% of the work related to the Improvements have been completed and Contractor and Borrower have complied with the provisions of Paragraph 3 of this Agreement. A second request for construction advance for 50% of the Amount Available for Construction ("Final Advance") may be submitted when the Improvements have been completed and accepted by Borrower and Lender and Contractor and Borrower have complied with the provisions of Paragraph 4 of this Agreement.

(e) If Contractor has not provided Lender and Borrower the Bond permitted by this Agreement, Contractor may submit a request for 90% of the Amount Available for Construction when the Improvements have been completed and accepted by Borrower and Lender, and Contractor and Borrower have complied with the provisions of Paragraph 4 (except as to the Bond) of this Agreement.

(f) All requests for construction advances shall comply with Subchapter K, Chapter 53, Texas Property Code, and be made on forms approved by Lender. Each construction advance shall be in an amount equal to the Amount Available for Construction times the applicable percentage as determined by Lender and/or its inspectors. Lender may prepare a chart for determining the percentage of completion and the schedule of advances to be made by Lender, and Lender may limit advances according to the schedule based on the percentage of the Improvements that are complete at the time of any request for construction advance.

(g) Whenever in the sole opinion of Lender the cost of completing the Improvements pursuant to the plans and specifications approved by Lender exceeds the total amount of unadvanced loan proceeds, Borrower, at Lender's request, shall pay such excess to the satisfaction of Lender prior to any further advances under the Note.

2. Lender's Payments on Behalf of Borrower. Lender shall make payments for the cost of construction of the Improvements by check payable to the Owner and Contractor, or to Contractor, and in Lender's discretion, following Contractor's default under this Agreement or the Contract, jointly to Contractor and Contractor's subcontractors or suppliers.

3. Conditions to Initial Advance. Lender shall have no obligation to make the Initial Advance of funds to Borrower unless and until Contractor has furnished Borrower and Lender the Bond permitted by this Contract, and the following conditions have been satisfied:

(a) Borrower has executed and delivered to Lender this Agreement, the Contract, the Note, the Deed of Trust, the Owner-Occupied Rehabilitation Loan Program Contract of even date herewith by and between Borrower and Lender, and Affidavit of Commencement and other documents securing the loan evidenced by the Note; and Contractor has executed and delivered to Lender this Agreement, the Contract, an Affidavit of Commencement and other documents securing the loan evidenced by the Note;

(b) Borrower and Contractor have furnished Lender all documents required by Lender to evidence compliance with Subchapter K, Chapter 53, Texas Property Code;

(c) To the extent applicable, Contractor has furnished Lender evidence that Contractor has established a construction account in compliance with Chapter 162, Texas Property Code;

(d) Contractor has provided Lender a copy of the final plans and specifications for the construction of the Improvements acceptable to Lender, along with a timetable and budget for completion of the Improvements as required by this Agreement and the Contractor's accepted bid;

(e) Contractor has provided Lender a copy of the building permit for the Improvements;

(f) Contractor has provided Borrower and Lender a list of all subcontractors used or to be used for completion of the Improvements, and executed partial releases and lien waivers from Contractor and any subcontractors and suppliers who performed work and/or materials at any time in connection with the Improvements, in a form acceptable to Lender, for all amounts to be disbursed to Contractor against the Amount Available for Construction;

(g) Contractor has provided Lender a copy of all insurance policies, which Contractor is required to maintain under the Contract, or in lieu thereof, a certificate of insurance which confirms Contractor has obtained all insurance required under the Contract;

(h) Contractor has provided Lender evidence that Contractor is in compliance with Chapter 416, Texas Property Code; and

(i) Borrower and Contractor have provided Lender such other items as Lender shall reasonably require.

4. Final Advance. The Final Advance (except for retainage, which will be disbursed in accordance with paragraph 5) shall be disbursed at the completion of the Improvements when Contractor has delivered to Lender all documents required under Paragraph 3 and the following:

(a) an affidavit of completion executed by Borrower and Contractor (the "Affidavit of Completion"), a final bills- paid affidavit executed by Contractor (the "Final Bills-Paid Affidavit"), and final waivers of lien and releases executed by Contractor and any subcontractors and suppliers who performed work and/or materials at any time in connection

with the Improvements (collectively, the "Releases"), which documents comply with Subchapter K, Chapter 53, Texas Property Code and are acceptable to Lender, together with supporting evidence that: (i) the construction work for the Improvements has been fully completed; and (ii) all bills for labor and material have been paid in full;

(b) Evidence that Borrower and Contractor have complied with all applicable laws pertaining to the location, development, and construction of the Improvements and that all governmental authorities having jurisdiction have approved: (i) the location, development, and construction of the Improvements to the Property; and (ii) all other matters requiring approval by governmental authorities; and

(c) Borrower and Contractor have provided such other items as Lender shall reasonably require.

5. Disbursement of Retainage. The retainage will not be disbursed until: (i) (a) the Releases have been filed in the Real Property Records of Hidalgo County, Texas, (b) the deadline to file an affidavit claiming a lien against the Property in connection with the Improvements (that is, the fifteenth (15th) day of the third calendar month after the day the indebtedness accrues) has expired and no such affidavits have been filed, or (c) if any affidavits claiming a lien against the Property in connection with the Improvements have been filed, the claims set forth in such affidavits have been resolved and the affidavits have been released of record; (iii) the Affidavit of Completion and the Final Bills-Paid Affidavit have been filed in the Real Property Records of Hidalgo County, Texas; and (iv) Borrower and Contractor have complied with Paragraph 4 of this Agreement.

6. Inspections. Lender shall be entitled to: (i) use its own personnel; or (ii) to designate an architect, engineer or other third party; to make any inspections or certifications required by Lender, and Lender shall not be required to make any loan advance until Lender has received inspections and certifications satisfactory to it. Prior to each loan advance, and at such other times as Lender may require, either Borrower or Contractor will be required to call for a physical inspection by Lender or other party designated by Lender.

7. Borrower's and Contractor's Additional Obligations. Borrower and Contractor further agree that:

(a) The Improvements will be constructed and fully equipped in a good and workmanlike manner with materials of high quality, using all new materials, strictly in accordance with the plans and specifications approved by Lender, and that the Improvements will comply with: (i) all applicable Housing Quality Standards contained in 24 Code of Federal Regulations, as amended, if the Property is located outside the jurisdiction of a municipality; or (ii) all applicable local building codes and ordinances of the municipality if the Property is located within the jurisdiction of a municipality, unless the municipality has no local building codes and ordinances, in which event Owner shall comply with all applicable Housing Quality Standards contained in 24 Code of Federal Regulations, as amended;

(b) No changes will be made in the plans and specifications submitted to Lender except on the written approval of the same by Lender;

(c) No extras shall be allowed to any contractor or subcontractor or any change made in any contract or subcontract without the Lender's prior written approval and consent;

(d) Contractor will promptly furnish Lender, at Lender's request, after execution thereof, executed copies of all contracts between Contractor and subcontractors, and of all contracts between Contractor and its suppliers, as well as contracts between subcontractors and their suppliers;

(e) Borrower and Contractor will cooperate with Lender in arranging for inspections by representatives of Lender of the progress of construction from time to time and will promptly comply with Lender's requirements or satisfy any objections regarding construction of the Improvements or the progress thereof;

(f) Borrower and Contractor will not suffer or permit any mechanics' or materialmen's lien claims to be filed or otherwise asserted against the Property and will promptly discharge the same in case of the filing of any claims for lien or proceedings for the enforcement thereof; provided, however, that Borrower shall have the right to contest in good faith and with reasonable diligence the validity of any such lien or claim on furnishing to Lender such security or indemnity as it may require;

(g) Borrower will pay all real estate taxes and assessments of every kind on the Property before the same become delinquent, and Lender may at any time require Borrower to provide evidence that taxes have been paid current;

(h) In the event that Lender shall expend any amount in performance of any of Borrower's covenants or agreements under the Note or any document securing the Note, such amounts shall constitute additional indebtedness secured under the Contract;

(i) All of the personal property, fixtures, attachments, and equipment delivered on, attached to, or used in connection with the construction of the Improvements or the operation thereof will be kept free and clear of all liens, encumbrances, and security interests whatsoever, and Borrower will be the absolute owner of such personal property, fixtures, attachments, and equipment and Contractor and Borrower will, from time to time, furnish Lender with satisfactory evidence of such ownership, including searches of applicable public records;

(j) Borrower and Contractor will comply with their respective obligations under this Agreement and the Contract and with all applicable laws, rules, ordinances and regulations;

(k) Borrower and Contractor will comply with the Special Conditions, if any, set forth in Exhibit "C" attached hereto;

(l) Contractor will pay all premiums on all insurance policies required from time to time during the progress of construction, and furnish to Lender additional and renewal insurance policies with companies, coverage, and amounts satisfactory to Lender; and

(m) Contractor will keep accurate and proper books and records of the construction of the Improvements, and will at all reasonable hours allow Lender or its representative to examine such books and records and all contracts and bills relating to the construction of the Improvements.

(n) Contractor shall not discriminate against any employee or applicant for employment because of sex, race, creed, color, national origin or handicap and shall take affirmative action to ensure that during the application process and during employment applicants and employees are treated without regard to their race, creed, color, national origin or handicap. Such action shall include, but not be limited to hiring and employment, upgrading, demotion or transfer, recruitment or recruitment advertising, layoff or termination, rates of pay or other forms of compensation; and selection for training, including apprenticeship. Contractor shall continuously post in conspicuous places, readily available to employees and applicants for employment, notices to be provided or approved by the County of Hidalgo, setting forth the provisions of this non-discrimination provision and such other notices as may be required by law.

8. Actions For Lender's Benefit Only. **THE AUTHORITY HEREIN CONFERRED ON LENDER AND ANY ACTION TAKEN BY LENDER IN MAKING INSPECTIONS OF THE PROPERTY, PROCURING SWORN STATEMENTS AND WAIVERS OF LIENS, APPROVING CONTRACTS AND SUBCONTRACTS AND APPROVING PLANS AND SPECIFICATIONS WILL BE TAKEN BY LENDER FOR ITS OWN PROTECTION ONLY, AND LENDER SHALL NOT BE DEEMED TO HAVE ASSUMED ANY RESPONSIBILITY TO BORROWER OR ANY OTHER PERSON WITH RESPECT TO ANY SUCH ACTION HEREIN AUTHORIZED OR TAKEN BY LENDER OR WITH RESPECT TO THE PROPER CONSTRUCTION OF THE IMPROVEMENTS, PERFORMANCE OF CONTRACTS OR SUBCONTRACTS BY ANY CONTRACTORS OR SUBCONTRACTORS, OR PREVENTION OF CLAIMS FOR MECHANIC'S LIEN.**

9. Non-Waiver By Lender. No waiver of any breach or default hereunder shall constitute or be construed as a waiver by Lender of any subsequent breach or default or of any breach or default of any other provision. No waiver of any term or provision of this Agreement shall be binding unless executed in writing by the party entitled to the benefit thereof. Pursuit by Lender of any remedies set forth in this Agreement does not preclude pursuit by Lender of other remedies in this Agreement or provided by law.

10. Conflict of Interest. **BORROWER AND CONTRACTOR REPRESENT AND WARRANT TO LENDER THAT, TO THE BEST OF THEIR KNOWLEDGE, NO EMPLOYEE, AGENT, CONSULTANT, OFFICER, OR ELECTED OR APPOINTED OFFICIAL OF LENDER WHO EXERCISES OR HAS EXERCISED ANY FUNCTIONS OR RESPONSIBILITIES WITH RESPECT TO THE ACTIVITIES ASSISTED WITH THE LENDER'S OWNER-OCCUPIED REHABILITATION LOAN PROGRAM OR WHO ARE IN A POSITION TO PARTICIPATE IN A DECISION MAKING PROCESS OR GAIN INSIDE INFORMATION WITH REGARD TO THESE ACTIVITIES, DURING THEIR TENURE OR WITHIN ONE YEAR THEREAFTER, HAS A FINANCIAL INTEREST OR BENEFIT IN THE LOAN RELATED TO THIS AGREEMENT, OR THE PROCEEDS THEREUNDER, EITHER FOR THEMSELVES OR THOSE WITH WHOM THEY HAVE FAMILY OR BUSINESS TIES.**

11. Dispute Resolution. All disputes between Contractor and Borrower regarding the construction project which is the subject of this Agreement, including, but not limited to, all disputes with regard to the Contract and this Agreement, shall, in the first instance, be submitted, in writing, with supporting documentation, within ten (10) days of the incident giving rise to the dispute, to Lender's program director having responsibility for the Lender's owner-occupied rehabilitation loan program for resolution. Except for good cause shown, any dispute not submitted within such ten (10) day period shall be deemed waived. While a dispute is pending, Contractor and Borrower shall otherwise proceed to perform all obligations under the Contract and this Agreement not otherwise in dispute.

12. Sole and Only Agreement. This Agreement and its exhibits and the instruments executed in connection therewith constitute the sole and only agreement of the parties hereto and supersedes any prior understandings or written or oral agreements between the parties respecting the within subject matter.

13. Severability. If one or more provisions of this Agreement are held to be unenforceable under applicable law, such provisions shall be excluded from this Agreement and the balance of this Agreement shall be interpreted as if such provisions were so excluded and shall be enforceable in accordance with its terms.

14. Interpretation. No provision of this Agreement will be interpreted in favor of, or against, any of the parties hereto by reason of the extent to which any such party or its counsel participated in the drafting thereof or by reason of the extent to which any such provision is inconsistent with any prior draft hereof or thereof. In the event of a conflict between this Agreement, the Mechanic's Lien Contract and/or the Rehabilitation Contract, the provisions in the document containing the most stringent requirement for the matter in dispute shall control

15. Jurisdiction and Venue. The parties agree that any suit, action or proceeding brought by a party against the other in connection with or arising from this Agreement ("Judicial Action") shall be brought only in any United States Federal or Texas state court located in Hidalgo County,

Texas and the parties hereby consent to the exclusive jurisdiction of such courts (and the appropriate appellate courts) in any such Judicial Action and waives any objection to venue laid therein. If either party is a prevailing party in a Judicial Action, such party is entitled to recover from the non-prevailing party all costs of such proceeding and reasonable attorney's fees.

16. General Provisions. This Agreement:

- a. may not be assigned by Owner or Contractor without the prior written consent of County;
- b. may not be amended or modified, in whole or in part, unless such amendment or modification is executed in writing by both parties;
- c. binds and inures to the benefit of the parties and their respective heirs, successors and permitted assigns; and
- d. is for the sole benefit of the parties hereto and their respective heirs, successors and permitted assigns. Nothing herein shall give, or be construed to give, any legal or equitable rights hereunder to any other person or entity other than the parties hereto and their respective heirs, successors and permitted assigns.

NOTICE

ANY HOLDER OF THIS CONSUMER CREDIT CONTRACT IS SUBJECT TO ALL CLAIMS AND DEFENSES WHICH THE DEBTOR COULD ASSERT AGAINST THE SELLER OF GOODS OR SERVICES OBTAINED PURSUANT HERETO OR WITH THE PROCEEDS HEREOF. RECOVERY HEREUNDER BY THE DEBTOR SHALL NOT EXCEED AMOUNTS PAID BY THE DEBTOR HEREUNDER.

IMPORTANT NOTICE: YOU AND YOUR CONTRACTOR ARE RESPONSIBLE FOR MEETING THE TERMS AND CONDITIONS OF THIS CONTRACT. IF YOU SIGN THIS CONTRACT AND YOU FAIL TO MEET THE TERMS AND CONDITIONS OF THIS CONTRACT, YOU MAY LOSE YOUR LEGAL OWNERSHIP RIGHTS IN YOUR HOME. KNOW YOUR RIGHTS AND DUTIES UNDER THE LAW.

RESIDENTIAL CONSTRUCTION LIABILITY ACT (RCLA) NOTICE

This contract is subject to Chapter 27 of the Texas Property Code. The provisions of that chapter may affect your right to recover damages arising from the performance of this contract. If you have a complaint concerning a construction defect arising from the performance of this contract and that defect has not been corrected through normal warranty service, you must provide the notice required by Chapter 27 of the Texas Property Code to the contractor by certified mail, return receipt requested, not later than the 60th day before the date you file suit to recover damages in a court of law or initiate arbitration. The notice must refer to Chapter 27 of the Texas Property Code and must describe the construction defect. If requested by the contractor, you must provide the contractor an opportunity to inspect and cure the defect as

provided by Section 27.004 of the Texas Property Code.

BORROWER(S):

Arturo Ramirez

Oralia C. Ramirez

YOU, THE OWNER, MAY CANCEL THIS TRANSACTION AT ANY TIME BEFORE MIDNIGHT OF THE THIRD BUSINESS DAY AFTER THE DATE OF THIS TRANSACTION. SEE THE ATTACHED NOTICE OF CANCELLATION FORM FOR AN EXPLANATION OF THIS RIGHT.

LENDER:

COUNTY OF HIDALGO, a political subdivision
of the State of Texas

By: **Diana R. Serna**
Its: **Director of Urban County Program**

CONTRACTOR:

By: **Rene Garza**
Its: **R G Enterprises, LLC, dba
G & G Contractors**

APPROVED AS TO FORM
Atlas & Hall, L.L.P.
By: Steve Crain
Date: June 19, 2013

STATE OF TEXAS §
 §
COUNTY OF HIDALGO §

This instrument was acknowledged before me on this **21** day of **March, 2017** by **Diana R. Serna, Director of Urban County Program of the County of Hidalgo**, a political subdivision of the State of Texas, on behalf of said political subdivision.

NOTARY PUBLIC, STATE OF TEXAS

STATE OF TEXAS §
 §
COUNTY OF HIDALGO §

This instrument was acknowledged before me on this **21** of **March 2017**, by **Arturo Ramirez.**

NOTARY PUBLIC, STATE OF TEXAS

STATE OF TEXAS §
 §
COUNTY OF HIDALGO §

This instrument was acknowledged before me on this **21** of **March 2017**, by **Oralia C. Ramirez.**

NOTARY PUBLIC, STATE OF TEXAS

STATE OF TEXAS §
 §
COUNTY OF HIDALGO §

This instrument was acknowledged before me on this **21** day of **March 2017**, by **Rene Garza with R G Enterprises, LLC, dba G & G Contractors.**

NOTARY PUBLIC, STATE OF TEXAS

YOU MAY CANCEL THIS TRANSACTION, WITHOUT ANY PENALTY OR OBLIGATION, WITHIN THREE BUSINESS DAYS FROM THE ABOVE DATE.

IF YOU CANCEL, ANY PROPERTY TRADED IN, ANY PAYMENTS MADE BY YOU UNDER THE CONTRACT OR SALE, AND ANY NEGOTIABLE INSTRUMENT EXECUTED BY YOU WILL BE RETURNED WITHIN TEN BUSINESS DAYS FOLLOWING RECEIPT BY THE MERCHANT OF YOUR CANCELLATION NOTICE, AND ANY SECURITY INTEREST ARISING OUT OF THE TRANSACTION WILL BE CANCELED.

IF YOU CANCEL YOU MUST MAKE AVAILABLE TO THE MERCHANT AT YOUR RESIDENCE, IN SUBSTANTIALLY AS GOOD CONDITION AS WHEN RECEIVED, ANY GOODS DELIVERED TO YOU UNDER THIS CONTRACT OR SALE; OR YOU MAY IF YOU WISH, COMPLY WITH THE INSTRUCTIONS OF THE MERCHANT REGARDING THE RETURN SHIPMENT OF THE GOODS AT THE MERCHANT'S EXPENSE AND RISK.

IF YOU DO NOT AGREE TO RETURN THE GOODS TO THE MERCHANT OR IF THE MERCHANT DOES NOT PICK THEM UP WITHIN TWENTY DAYS OF THE DATE OF YOUR NOTICE OF CANCELLATION, YOU MAY RETAIN OR DISPOSE OF THE GOODS WITHOUT ANY FURTHER OBLIGATION.

TO CANCEL THIS TRANSACTION, MAIL OR DELIVER A SIGNED AND DATED COPY OF THIS CANCELLATION NOTICE OR ANY OTHER WRITTEN NOTICE, OR SEND A TELEGRAM, TO RENE GARZA, R G ENTERPRISES, LLC, DBA G & G CONTRACTORS , AT 711 E. WISCONSIN RD, EDINBURG, TEXAS 78539 NOT LATER THAN MIDNIGHT OF MARCH 24, 2017.

I HEREBY CANCEL THIS TRANSACTION.

Dated: _____.

OWNER(S):

Arturo Ramirez

Oralia C. Ramirez

EXHIBIT "A"
LEGAL DESCRIPTION OF THE PROPERTY

Lot 10 Collin Subdivision, a Re-subdivision of the South 10 acres of the North 20 acres of Lot 14, Block 95, MO-TEX, Hidalgo County Texas.

EXHIBIT "B"
PLANS AND SPECIFICATIONS,
TIMETABLE
AND
BUDGET

RAMIREZ RESIDENCE

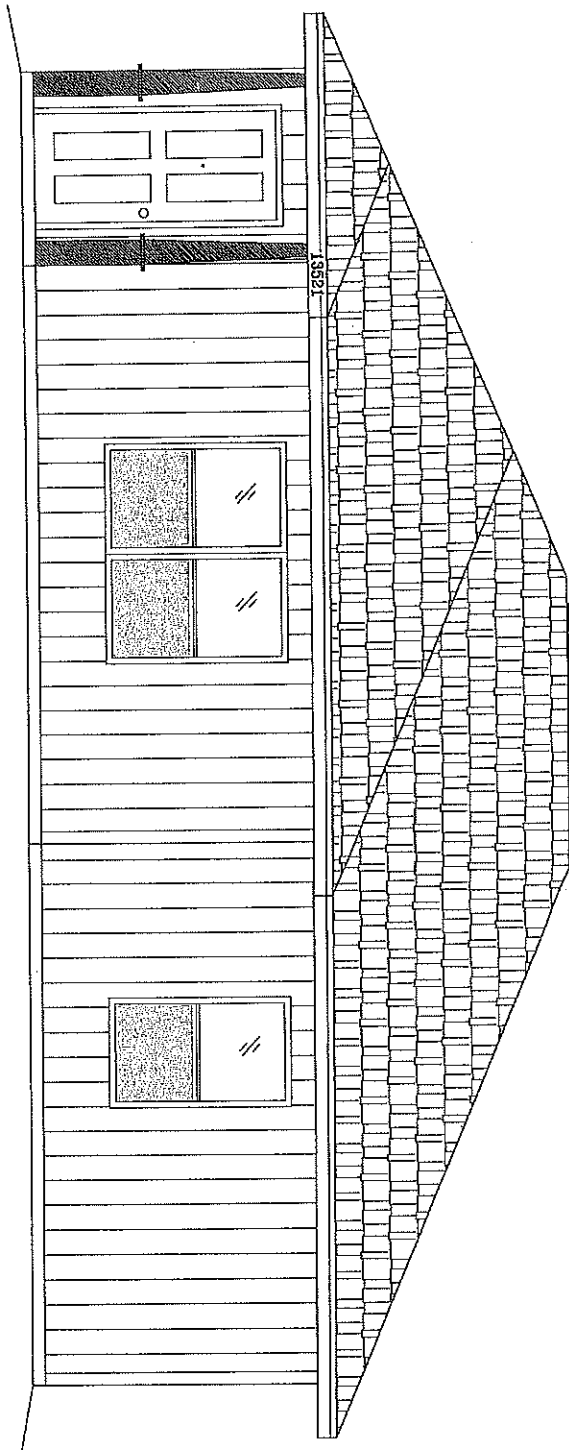

ARTURO & ORALIA RAMIREZ
13521 COLLIN DRIVE
EDINBURG, TX. 78542
(956) 272-8584
(956) 414-1351

URBAN COUNTY PROGRAM
427 E. DURANTA STE 107-ALAMO
(956) 787-8127

URBAN COUNTY PROGRAM
OWNER OCCUPIED HOUSING REHABILITATION PROGRAM

C1.0

ARTURO & ORALIA RAMIREZ
13521 COLLIN DRIVE., EDINBURG, TX.

TOTAL AREA
1064 SQ. FT.

1 FLOOR PLAN

3/16" = 1'-0"

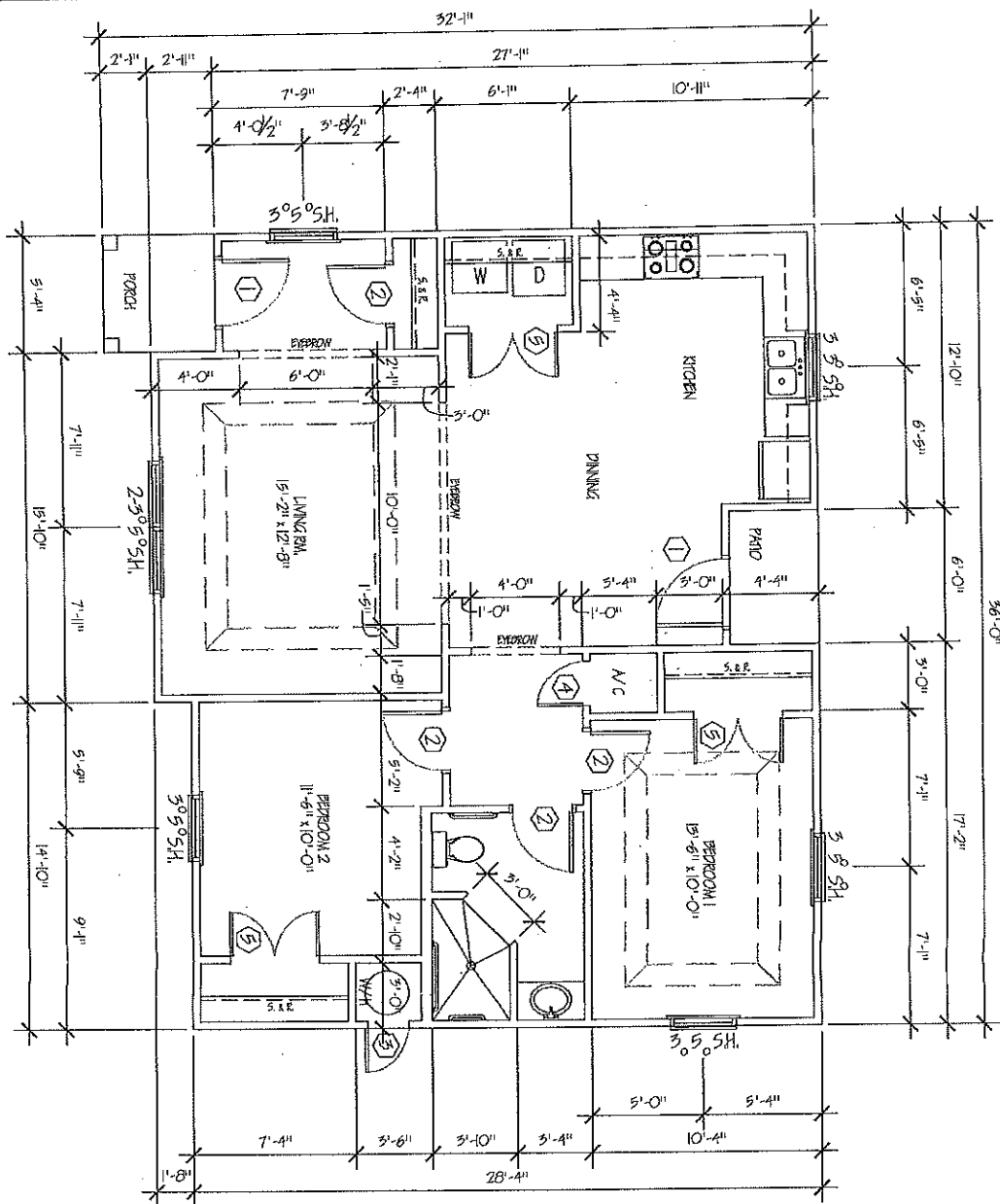

SQUARE FOOTAGE

LIVING AREA	106
PORCH/TERR	49
TOTAL SQ. FT.	1064

DOOR SCHEDULE

TYPE	SIZE	TYPE	LOOKS
1	INSUAL NEW/INT W/ DUAL PEEK HOLES	9-0	INSUAL W/ LOW PROFILE HERRL
2	INSUAL NEW/INT	2-8	HOLLOW CORE
3	INSUAL NEW/INT	2-0	HOLLOW CORE
4	INSUAL NEW/INT	2-0	HOLLOW CORE
5	INSUAL NEW/INT	(2) 2-0	HOLLOW CORE

GENERAL NOTES

- 5/12 GLOVE WITH 6" OVERHANG
- SPRINKLER/SCAFFOLD VENTS WHERE NEEDED
- INSUAL PORCH BALING WHERE FINISH GRADE IS LOWER THAN 1" FROM PORCH FLOOR
- INSUAL PORCH STIPS WHERE FINISH GRADE IS LOWER THAN 6" FROM PORCH FLOOR
- C/BENT IS BEARING CONNECTIONS FOR A D/S (ELECTRIC RIGID)
- INSUAL A MIN OF TWO PRONG JACS & CABLE CONNECTIONS AS PER OWNERS REQUEST
- EXTERIOR COLOR CHOICES TO BE OR W/ARCH
- SCHEDULE B
- SCHEDULE C
- SCHEDULE D
- SCHEDULE E
- SCHEDULE F
- SCHEDULE G
- SCHEDULE H
- SCHEDULE I
- SCHEDULE J
- SCHEDULE K
- SCHEDULE L
- SCHEDULE M
- SCHEDULE N
- SCHEDULE O
- SCHEDULE P
- SCHEDULE Q
- SCHEDULE R
- SCHEDULE S
- SCHEDULE T
- SCHEDULE U
- SCHEDULE V
- SCHEDULE W
- SCHEDULE X
- SCHEDULE Y
- SCHEDULE Z

I HAVE READ AND FULLY AGREE WITH THE WRITE-UP AND PLANS AS PRESENTED TO ME THIS 3RD DAY OF Feb 2004
 Arturo Ramirez
 Oralia Ramirez

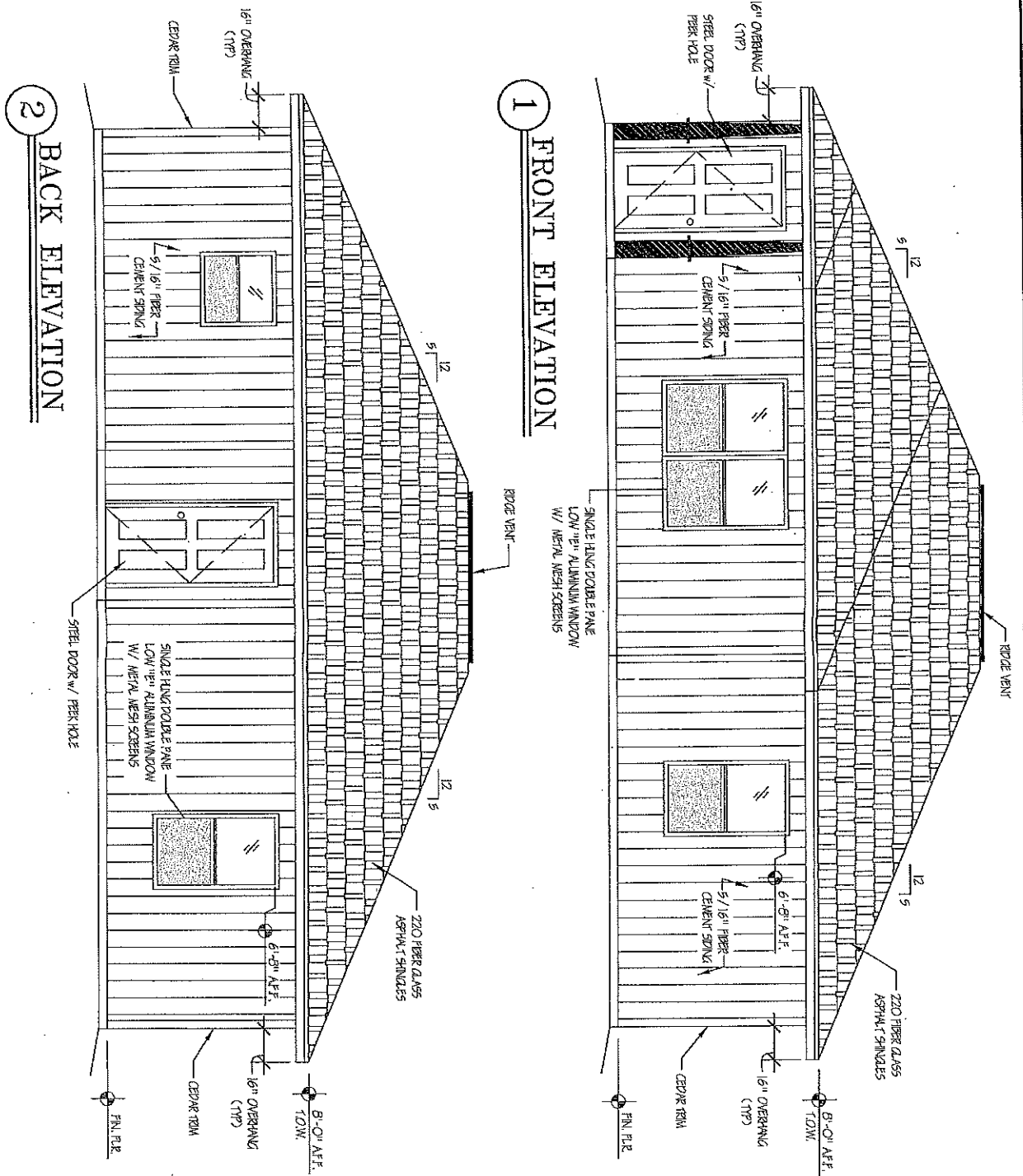

1 FRONT ELEVATION

2 BACK ELEVATION

URBAN COUNTY PROGRAM
 OWNER OCCUPIED HOUSING REHABILITATION PROGRAM

ARTURO & ORALIA RAMIREZ
 13521 COLLIN DRIVE, EDINBURG, TX.

TOTAL AREA
 1064 SQ. FT.

A1.2

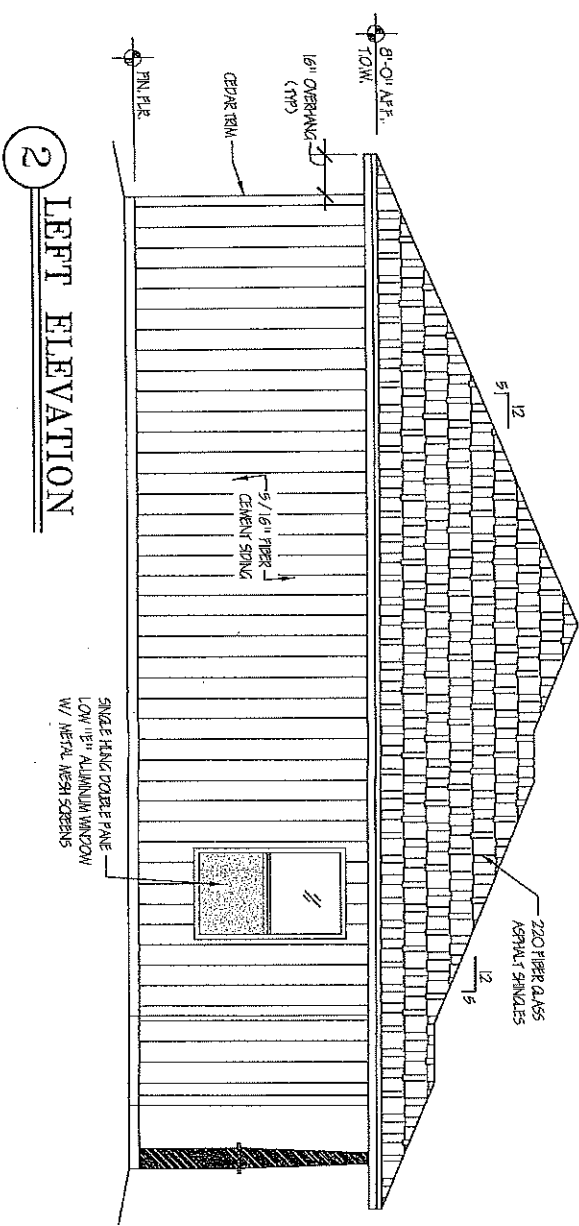

2 LEFT ELEVATION

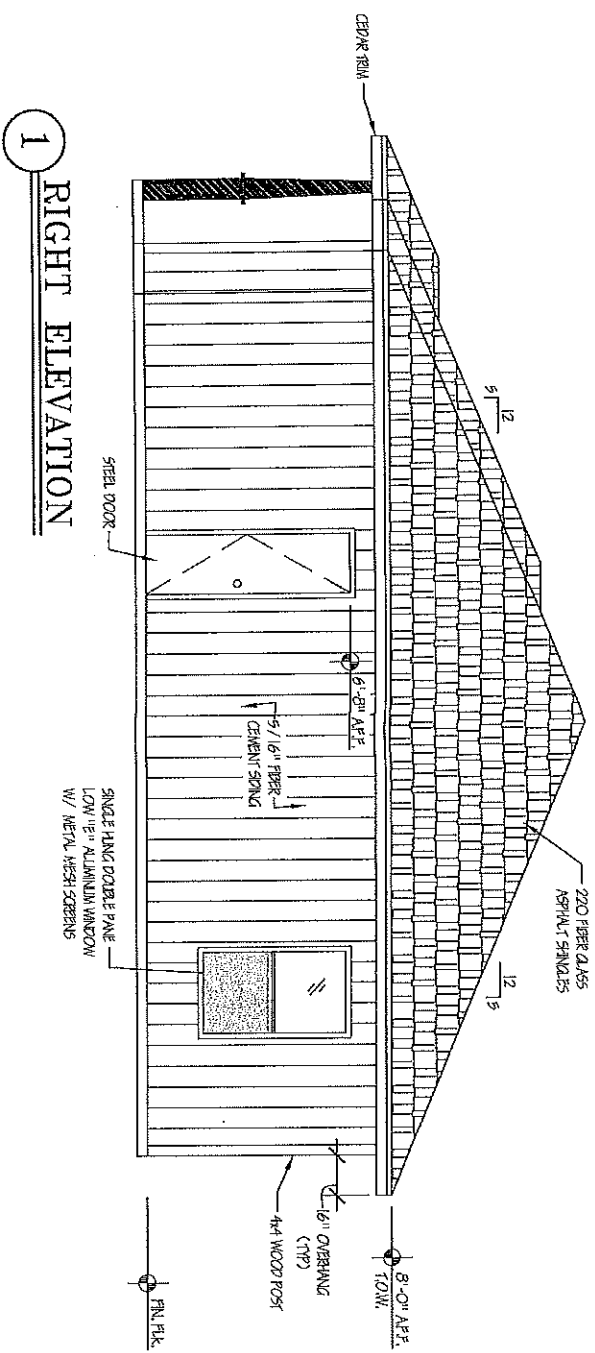

1 RIGHT ELEVATION



URBAN COUNTY PROGRAM
OWNER OCCUPIED HOUSING REHABILITATION PROGRAM



A1.3

ARTURO & ORALIA RAMIREZ
13521 COLLIN DRIVE., EDINBURG, TX.

TOTAL AREA
1064 SQ. FT.

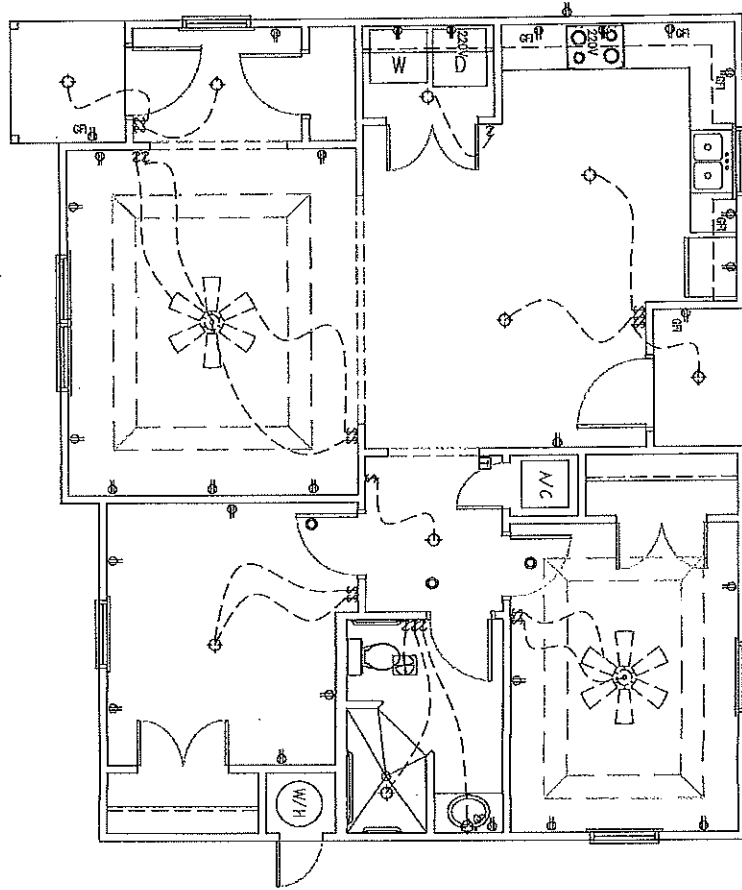

1
3/16" = 1'-0"
ELECTRICAL PLAN

ELECTRICAL LEGEND

(H)	WIRE PACE	⊕	LIGHT FIXTURE
⊕	NEW OR EXISTING ELECTRICAL RECEPT	\$	LIGHT SWITCH
220V	220V ELECTRICAL RECEPT	⊖	TRANSFORMER
GF	GROUNDING DEVICE	○	SMOKE DETECTOR
GF	GROUNDING DEVICE		
⊗	PARALLEL BRANCHING		

I	URBAN COUNTY PROGRAM OWNER OCCUPIED HOUSING REHABILITATION PROGRAM	I
E1.1	ARTURO & ORALIA RAMIREZ 13521 COLLIN DRIVE., EDINBURG, TX.	TOTAL AREA 1064 SQ. FT.

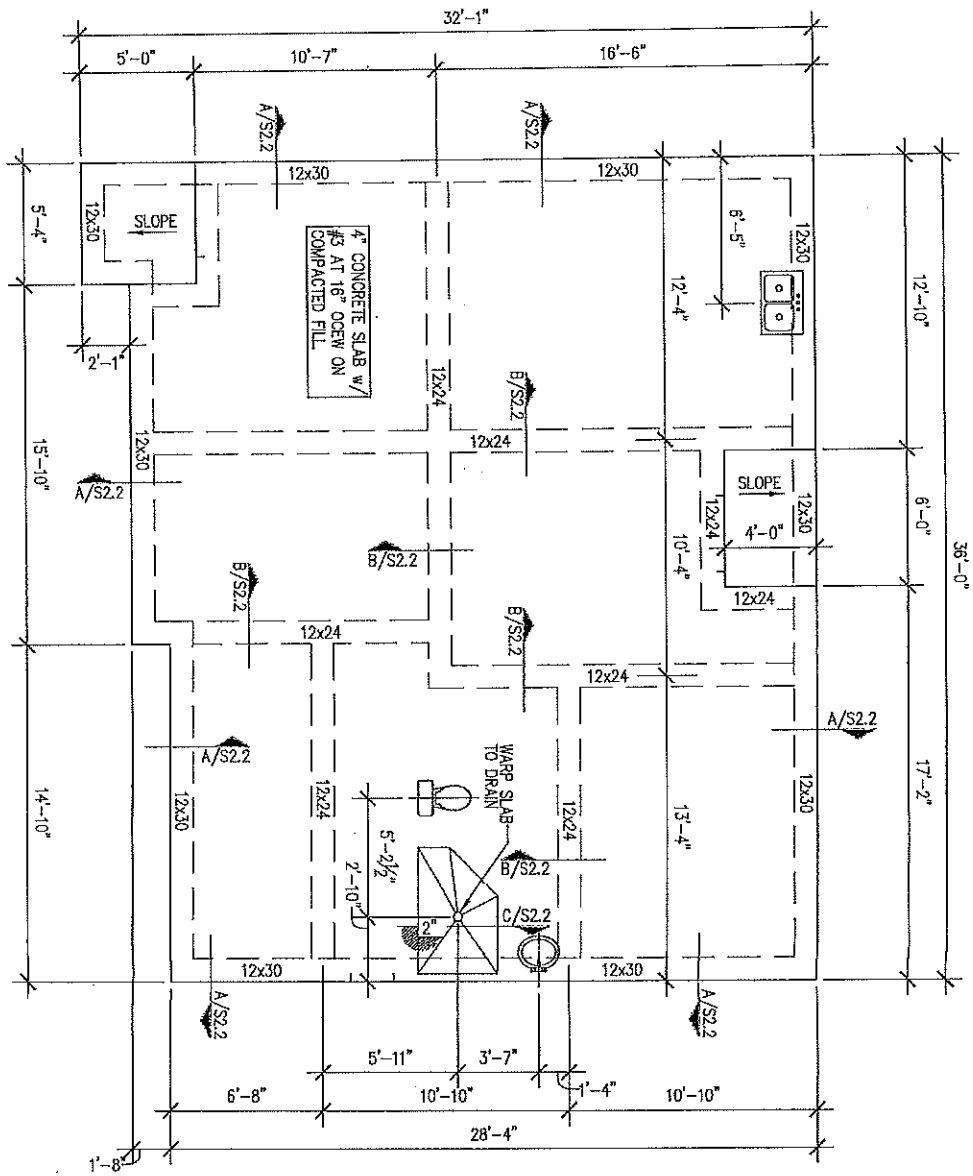

1 FOUNDATION PLAN

$\frac{3}{16}'' = 1'-0''$

- NOTES:
1. 4" THICK SLAB ON GRADE w/ #3 BARS AT 18" O.C.E.W. AT MID-DEPTH OF SLAB OVER 6 MIL. W/SCREEN OVER APPROVED COMPACTED FILL.
 2. EXTERIOR GRADE BEAMS TO BE 12"x30" w/ 4-#5 BARS CONT. TOP AND BOTTOM w/ #3 STRRUPS AT 24" o/c. A MINIMUM OF 6" IN DEPTH TO UNDISTURBED SOIL.
 3. INTERIOR GRADE BEAMS TO BE 12"x24" w/ 4-#5 BARS CONT. TOP AND BOTTOM w/ #3 STRRUPS AT 24" o/c. A MINIMUM OF 6" IN DEPTH TO UNDISTURBED SOIL.
 4. CORNER BARS AT ALL CORNERS AND INTERSECTIONS SHALL BE #5 x 2'-0"x2'-0". APPLY 6x6 WIRE MESH AT SIDEWALKS AND DRIVEWAYS.
 5. INSTALL ANCHOR BOLTS AT PERIMETER AT 48" o/c.
 6. USE ONLY COMPACTED SELECT FILL DIRT. FINISH FLOOR TO BE 18" FROM TOP OF CURB, UNLESS OTHERWISE NOTED.

URBAN COUNTY PROGRAM
OWNER OCCUPIED HOUSING REHABILITATION PROGRAM



S2.1

ARTURO & ORALIA RAMIREZ
13521 COLLIN DRIVE., EDINBURG, TX.



TOTAL AREA
1064 SQ. FT.

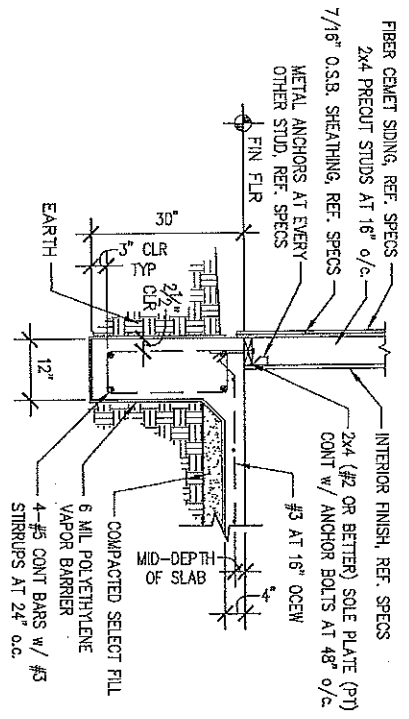

A-EXTERIOR BEAM

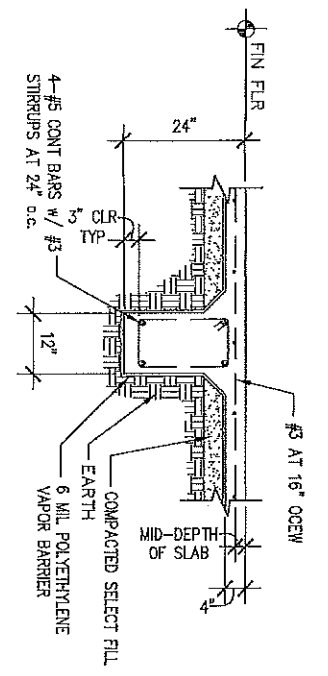

B-INTERIOR BEAM

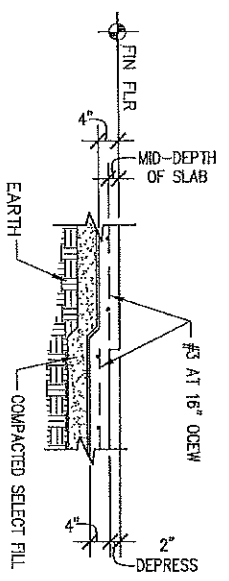

C-SHOWER DEPRESS

URBAN COUNTY PROGRAM
 OWNER OCCUPIED HOUSING REHABILITATION PROGRAM



S2.2

ARTURO & ORALLA RAMIREZ
 13521 COLLIN DRIVE, EDINBURG, TX.



TOTAL AREA
 1064 SQ. FT.

SPECIFICATIONS

ALL SPECIFICATIONS SHALL ASSUME THE USE OF CONTRACTOR'S MINIMUM GENERAL SPECIFICATIONS MANUAL

OWNER (S) ARTURO & ORALLIA RAMIREZ CASE NO.: # 3190 DATE: 2/3/17 ADDRESS: 13521 COLLIN DRIVE, EDINBURG, TX PHONE: 956-272-8584 BY: ROBERT CAVAZOS

1. FOUNDATION WORK:

- BUILD A NEW SLAB ON GRADE FOUNDATION TO COMPLY WITH PLANS, SPECS CITY AND / COUNTY REQUIREMENTS, PROJECTS TO BE 18" ABOVE CENTER LINE OF STREET OR CURB OR 12" ABOVE NATURAL GROUND, WHICHEVER IS GREATER, PROVIDE CONCRETE SLAB FOR A/C UNIT. PROVIDE A MIN. OF 12 X 25 DRIVEWAY (depending on city).

2. PLUMBING GENERAL: (SEE SPECS)

- ALL PLUMBING ROUGH SHALL BE AS FOLLOWS:
- WATER SUPPLY TO HOUSE SHALL HAVE A 3/4" CUTOFF VALVE BEFORE ENTRY TO HOUSE.
- INTERIOR WATER SUPPLY LINES FOR HOUSE SHALL BE ALL NEW PEV OF APPROPRIATE DIAMETER
- NEW PEV PIPES AND FITTINGS
- OF 1" MINIMUM DIAMETER FOR ALL EXTERIOR WATER SUPPLY LINES BELOW GROUND.
- OF APPROPRIATE DIAMETER FOR DWV (DRAIN, WASTE, AND VENTS).
- SEWER CONNECTION SHALL HAVE (1) PLASTIC PVC SEWER CLEAN OUT.
- ALL PLUMBING FINISH SHALL BE AS FOLLOWS:
- RELATED PLUMBING ITEMS:
- (2) EXTERIOR HOSE BRASS AIR FAUCETS:
- 1/2" CUTOFF VALVES WITH ESCUTCHEONS FOR ALL FIXTURES, FIXTURES.
- PLUMBING SEALANT FOR ALL DRAINS, AND SINK PERIMETERS
- ALL OTHER RELATED PLUMBING (SEE SPECS)
- FIXTURES: (SEE SPECS)
- KITCHEN SINK W/ RELATED PLUMBING & FAUCETS
- PERISTAL SINK W/ RELATED PLUMBING & FAUCETS
- TOILET W/ MATCHING COLOR
- SHOWER WITH RELATED PLUMBING AND HANDICAP ACCESSIBLE.
- SHOWER FAUCETS & REMOVABLE SHOWER HEAD
- MEDICINE CABINET/TOWEL RACKS T.P. DISPENSER
- TOOTHBRUSH & SOAP HOLDER & SHOWER ROD (SEE SPECS)
- WATER HEATER INSTALLED AS PER SPECS (GAS OR ELECTRIC AS PER OWNER REQUEST)
- OTHER RELATED ITEMS
- RANGE CONNECTIONS AS PER OWNERS REQUEST (SEE SECTION 23.1)
- 4" DRYER EXHAUST VENT.
- IN WALL WASHING MACHINE BOX WITH BRASS FAUCETS & RELATED PLUMBING.
- HOOK UP ALL DRAINAGE LINES TO CITY SEWER SYSTEM IF AVAILABLE. SEE CITY FOR INFORMATION TEST SEPTIC SYSTEM IF EXISTING FOR INTEGRITY AND REPLACE IF NECESSARY AND MORE THAN 10 YEARS OF AGE

3. INTERIOR/EXTERIOR WALLS & CEILING:

- ALL INTERIOR AND EXTERIOR WALL FRAMING:
- 2x4" (4" OR BETTER) FOR USE IN: SOL E PLATES (TREATED LUMBER)
- DOUBLE TOP PLATES
- 92# PRE-CUT STUDS @ 16" O.C.
- 92# PRE-CUT STUDS @ 16" O.C.
- WINDOW SILLS
- CEILING JOIST CHAIN BLOCKING @ 48" O.C.
- 2x6" (4" OR BETTER) FOR USE IN:
- WINDOW & DOOR HEADERS WITH 1 1/2" PLYWOOD SPACER.
- CEILING JOIST @ 24" O.C., FOR CLEARANCES LARGER THAN 12'
- CEILING JOIST SHALL BE @ 16" O.C.

4. ROOF: (SLOPE=5/12)

- INSTALL BOOT TIES IN EVERY CORNER OF THE HOUSE ALONG WITH METAL ANCHORS ON BOTH BOTTOM AND TOP PLATES OF HOME
- ALL EXTERIOR CEILING COVERINGS:
- 3/8" CD EXTERIOR AT WOOD FOR PORCH CEILINGS.
- ALL INTERIOR WALL & CEILING COVERINGS:
- 1/2" SHEET ROCK FINISHED AS PER SPECS.
- 1/2" DAMP RESISTANT SHEET ROCK FOR BATH AREAS.
- ALL INTERIOR CEILING SHALL HAVE ORANGE PEEL TEXTURE.
- ALL INTERIOR WALL SURFACES SHALL HAVE ORANGE PEEL TEXTURE.
- ALL EXTERIOR TRIMMINGS SHOULD CONSIST OF CEDAR WOOD.

5. PORCH & CANOPY FLOORS:

- THE HOUSE SHALL HAVE PORCH FLOORS AS FOLLOWS:
- A RIDEBACK PORCH FLOOR.
- A SIDEBACK PORCH FLOOR.
- PROVIDE RAMP & 2x4 HANDRAILS TO EACH FRONT AND/OR SIDE PORCH STEPS

6. INSULATION:

- ALL LIVING AREA CEILINGS WITH BLOWN IN INSULATION TO AN R-48 FACTOR. (need a combined R-30 & R-19 to meet requirement)
- HAVE RULERS INSTALLED FOR EVERY 300 SQUARE FEET BEFORE FRAMING AND ROUGH-IN INSPECTION IS SCHEDULED.
- INSULATION FOAM SHALL BE USED AROUND ALL WINDOWS, WIRES, PLUMBING, ELECTRICAL, 2x4 BOTTOM PLATES, AND ALL PENETRATED AREAS.
- ALL PERIMETER WALLS WITH R-15 F.G. BATT.
- ALL EXTERIOR PRES EXPOSED TO WEATHER SHALL BE INSULATED.

7. INTERIOR FINISH:

- ALL TRIM SHALL BE INSTALLED AS PER SPECS
- ALL PAINT SHALL BE APPLIED AS PER SPECS (2 COATS WITH PAINT COMPARABLE IN QUALITY TO SHERWIN WILLIAMS. ALLOW A VARIETY OF DIFFERENT COLORS FOR CLIENT TO CHOOSE FROM. (2 COLOR CHOICE MIN).

8. EXTERIOR FINISH:

- PAINT ENTIRE HOUSE AS PER SPECS WITH PAINT COMPARABLE IN QUALITY TO SHERWIN WILLIAMS. PRIMER TO BE OIL BASED & PAINT MUST BE EQUIVALENT TO A-104 (2 COLOR CHOICE MIN).

9. SIDING:

- THE SIDING SHALL BE 9/16" FIBER CEMENT WITH ALL CEDAR TRIM TO ENTIRE HOUSE.
- INSTALL 7/16" O.S.B. TO THE ENTIRE PERIMETER OF THE HOUSE AS PER MANUFACTURER'S SPECIFICATIONS. REFERENCE DETAIL.

10. WINDOWS:

- SHALL BE NEW LOW-E DOUBLE PANE INSULATED ALUMINUM WINDOWS. SIZE AS PER PLAN. KEEP LABELS ON WINDOWS UNTIL FINAL INSPECTION HAS BEEN CLEARED.

11. CABINETS GENERAL:

- BUILD AND/OR INSTALL NEW KITCHEN CABINETS TO INCLUDE:
- A KITCHEN CABINET.
- A KITCHEN BATHROOM FORMICA COUNTER TOP OF MATCHING COLOR.
- BUILD AND/OR INSTALL A NEW VANITY CABINET (IF APPLICABLE) FOR BATHROOM WITH FORMICA TO MATCH LAUNDRY SINK AND WALLS. ALL CABINERY PIECES SHOULD BE NEW AND COMPLETE. AND BUILT TO PROFESSIONAL STANDARDS.

12. FLOOR, SUBFLOOR, & FINISH FLOORING:

- APPLY VCT FLOOR TILE TO ALL LIVING AREA HOUSE FLOORS.

13. ELECTRICAL GENERAL:

- ALL ELECTRICAL INSTALLATIONS & WORK AS PER ELECTRICAL CODE WITH THE FOLLOWING CONDITIONS:
- PROVIDE RANGE OUTLET AS PER OWNERS REQUEST.
- PROVIDE APPROPRIATE WASHER & DRYER CONNECTION.
- (2) 32' CEILING FANS (CEILING HUGGER STYLE) COMPATIBLE IN QUALITY TO THE HUMMER BRAND. THE CONTRACTOR SHALL ALLOW \$120.00 FOR MATERIAL & LABOR LOCATION AS PER OWNER REQUEST.
- INSTALL GFCI OUTLETS IN BATHROOMS, KITCHEN, AND EXTERIOR WALLS.
- EACH ELECTRICAL PANEL OR BREAKER BOX LIGHT SWITCH & THERMOSTAT NO HIGHER THAN 48" ABOVE FLOOR
- EACH ELECTRICAL PLUG TO BE 15' ABOVE THE FLOOR
- ANY OUTLETS WITHIN 6' FROM KITCHEN OR BATHROOM SINKS MUST BE GFCI

14. RANGE HOOD:

- INSTALL A RANGE HOOD TO FIT OWNERS RANGE SIZE (30" OR 36") AND VENT TO EXTERIOR

15. BATHROOM ACCESSORIES:

- ALL ACCESSORIES & MEDICINE CABINETS AS PER SPECS.
- INCLUDE CURTAIN ROD & PLASTIC RETAINING DAM TO HELP PREVENT WATER FROM ESCAPING SHOWER. INSTALL PERISTAL SINK AND CABINET ABOVE TOILET. (ALSO INCLUDE TOILET PAPER, TOOTHBRUSH AND SOAP HOLDER)

16. ACCESS FOR PHYSICAL DISABILITIES:

- INSTALL ONE CONC. RAMP AS PER OWNERS REQUEST THAT CONNEDS WITH 12 X 25 DRIVEWAY AND STEPS WITH HANDRAILS
- BATHROOM SHOULD ACCOMMODATE GRAB BARS WHERE INDICATED IN PLANS

17. HEATING & A/C:

- PROVIDE A INSTALL A 16 SEER CENTRAL AIR CONDITIONING COMPARABLE IN QUALITY TO A CARRIER BRAND UNIT FOR THE ENTIRE HOUSE. INCLUDE DIGITAL THERMOSTAT.

18. SMOKE DETECTORS:

- INSTALL A SMOKE DETECTOR INSIDE EACH SLEEPING ROOM, OUTSIDE SLEEPING ROOMS, ALL WIRED IN SERIES.

19. GENERAL NOTES:

- CONTRACTOR IS RESPONSIBLE FOR:
- YOUR BID TO INCLUDE ANY COST RELATED TO REQUIREMENTS FROM CITY, CHANGE ORDERS FOR THIS PARTICULAR PURPOSE WILL NOT BE ACCEPTED OR PROCESSED TO CORRECT THE ABOVE MENTIONED. YOUR BID TO INCLUDE ANY COST RELATED TO RES-CHECK & ENERGY COMPLIANCE REQUIREMENTS.
- THE DESIGNER AND DISPOSAL EXISTING STRUCTURE CONTRACTOR IS RESPONSIBLE FOR ANY DAMAGE TO EXISTING STRUCTURES, DRIVEWAYS, AND UTILITY LINES DURING DEMOLITION.
- THE COMPLIANCE OF ALL THE REQUIRED BUILDING ELEVATIONS.
- PROVIDE 6" OF LANDSCAPE DIRT AROUND THE HOUSE ALONG WITH SUFFICIENT GRASS SEEDS UP TO 10' OF PERIMETER.
- PROVIDING THE APPROPRIATE ELECTRICAL AND/OR GAS CONNECTIONS FOR RANGE AS PER APPLICANT'S REQUEST AND ACCORDING TO APPLICABLE PLUMBING/ELECTRICAL CODE.
- PROVIDE PHONE JACKS & CABLE CONNECTIONS IN EVERY BRN & LIVING SPACE. KITCHEN PHONE IF REQUESTED.
- PROVIDE TREATMENT PRE-TREATMENT TO ENTIRE FOUNDATION PAD.
- DETRIMMING, DISPLACING, AND SUBMITTING ALL PROPER PERMITS & INSPECTIONS.
- ALL CONTRACTORS WILL BE RESPONSIBLE FOR ANY ADDITIONAL PLANS, SPECIFICATIONS AND/OR DETAILS THAT ARE REQUIRED BY CITIES OR COUNTY AT THE TIME OF ATTAINING PERMITS.
- MINIMUM 12-26 CONC. DRIVEWAY WITH CONNECTING SIDEWALK TO RAMP FOR HANDICAP APPLICANTS.
- ALL THE GENERAL INFORMATION CONTAINED WITHIN SECTION 22. GENERAL NOTES OF THE CONTRACTOR'S GENERAL SPECIFICATIONS MANUAL.
- PROVIDE AND INSTALL PROJECTS SIGNS AT EACH CONSTRUCTION SITE PRIOR TO THE START OF CONSTRUCTION. FINES WILL BE ENFORCED.
- CONTRACTOR IS RESPONSIBLE FOR SUPPLYING PORT A POTTY THROUGHOUT CONSTRUCTION PROCESS (demo to final inspection) FINES WILL BE ENFORCED.
- SHOWER ENTRANCES TO BE 36" WIDE.
- ALL U/P HOMES MUST COMPLY WITH TEXAS GOVERNMENTAL CODE §2636.514

THE HOMEOWNER SHALL BE RESPONSIBLE FOR:

- REMOVE AND DISPOSE OF ALL DEBRIS ON SITE BEFORE THE BEGINNING OF CONSTRUCTION INCLUDING BUT NOT LIMITED TO TREES, NEARBY UNDEVELOPED OLD LUMBER, ETC.
- MAKING NECESSARY DEPOSITS FOR ANY UTILITIES TO BE CONNECTED TO THE NEW DWELLING.

SPECIFICATIONS

ALL SPECIFICATIONS SHALL ASSUME THE USE OF CONTRACTOR'S MINIMUM GENERAL SPECIFICATIONS MANUAL.

I HAVE READ AND FULLY AGREE WITH THE WRITE-UP AND PLANS AS PRESENTED TO ME.

Arturo
NAME OF APPLICANT

Walter P. Ramirez
NAME OF CO-APPLICANT

OWNER (S) ARTURO & ORALLIA RAMIREZ CASE NO. # 3190 DATE: 2/17 ADDRESS: 1321 COLLIN DRIVE, EDINBURG, TX PHONE: 956-272-8584 BY: ROBERT CAVAZOS

TIME TABLE

ACTIVITY	DATE(S)
Contract Signing	March 7, 2017
Demolition	March 16, 2017
Construction Start	March 17, 2017
Anticipated Draws	After 50% construction completion After 100% construction completion 30 days after construction completion
End Construction	June 5, 2017

BUDGET

	Total Cost
Pre-Development	\$ 0.00
Acquisition	\$ 0.00
Demolition/Construction	\$59,740.00
Other Costs:	\$ 0.00
TOTAL PROJECT COSTS	\$59,740.00

EXHIBIT "C"
SPECIAL CONDITIONS

None.