



2802 S. Bus. Hwy 281
Edinburg, Texas 78539
Phone: (956) 318-2626
Fax: (956) 318-2629
www.co.hidalgo.tx.us/purchasing

March 29, 2018

E-18-090

Rio Valley Pipe, LLC
Attn: Mr. Larry Hinojosa, Sales Administrator
3609 W. Palma Vista Drive
Palmview, TX 78572

Via email: sales@capatexas.com

TERM: 06/30/2018 – 06/29/2019

Re: **HB Form 1295 Required/Renewal/Extension Notice**
“C-17-046-05-30-“Pipes & Related Miscellaneous Items” Hidalgo County

Dear Mr. Larry Hinojosa:

Be advised, that in order to proceed with the County’s option to extend/renew for an additional **One (1) Year term, under the same rates, terms and conditions** with Rio Valley Pipe, LLC for the referenced project, the County is required, as of **January 1, 2016**, to comply with the Texas Government Code, §2252.908, and the rules issued by the Texas Ethics Commission found in Title 1, Section 46.1, 46.3 and 46.5 of the Texas Administrative Code. In accordance with these requirements for the type of contract being considered, a business must submit a completed **Certificate of Interested Parties Form 1295**, to the County before the County may enter into a contract with the business entity.

Thus, in order for County staff to process the above-referenced extension/renewal; you must complete Form 1295 and file Form 1295 with the Texas Ethics Commission. You can find the 1295 Form through the Texas Ethics Commission at the following website:

https://www.ethics.state.tx.us/whatsnew/elf_info_form1295.htm

In **box 3 of Form 1295**, provide **CONTRACT No. E-18-090** Once completed and filed with the Texas Ethics Commission, Form 1295 must be printed and signed an “*unsworn declaration*” and submitted to our office by the deadline stated below.

In order to proceed with approval of **Renewal/Extension** for referenced project by **Commissioners Court on April 17, 2018**, the signed and “*unsworn declaration*” “**HB Form 1295**” and “**Extension Notice**” must be received in our office completed via fax to (956) 292-7612 or via email to matilde.faz@co.hidalgo.tx.us **by no later than Friday, April 6, 2018**. Hidalgo County cannot enter into a contract until Form 1295 is submitted, therefore, failure to timely submit Form 1295 signed, and “*unsworn declaration*” may result in a delay of the award.

In, addition, please include your “**Updated Certificate of Insurance**” with acknowledgment of receipt to this notice by signing below and returning to the Hidalgo County Purchasing Department, via email: matilde.faz@co.hidalgo.tx.us by no later than date reflected above.

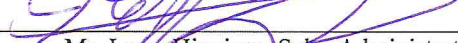
By: 
Mr. Larry Hinojosa, Sales Administrator

Date: 4-19-18

Hidalgo County Purchasing Department welcomes and appreciates your participation in the contract process. If any further assistance is required, please do not hesitate to call the Purchasing Department (956) 318-2626.

Sincerely,

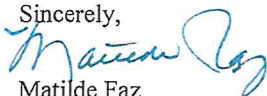

Matilde Faz
Hidalgo County Purchasing Department

xc: file

CERTIFICATE OF INTERESTED PARTIES

FORM 1295

1 of 1

Complete Nos. 1 - 4 and 6 if there are interested parties.
Complete Nos. 1, 2, 3, 5, and 6 if there are no interested parties.

OFFICE USE ONLY CERTIFICATION OF FILING

1 Name of business entity filing form, and the city, state and country of the business entity's place of business.
Rio Valley Pipe, LLC d/b/a CAPA
Palmview, TX United States

Certificate Number:
2018-341679

Date Filed:
04/19/2018

2 Name of governmental entity or state agency that is a party to the contract for which the form is being filed.
Hidalgo County Purchasing Department

Date Acknowledged:

3 Provide the identification number used by the governmental entity or state agency to track or identify the contract, and provide a description of the services, goods, or other property to be provided under the contract.
E-18-090
C-17-046-05-30 "Pipes & Related Miscellaneous Items - Hidalgo County

4	Name of Interested Party	City, State, Country (place of business)	Nature of interest (check applicable)	
			Controlling	Intermediary

5 Check only if there is NO Interested Party.

6 UNSWORN DECLARATION

My name is Larry Hinojosa, and my date of birth is 11-08-1957.

My address is 3609 W Palma Vista Dr, Palmview, TX, 78572, USA.
(street) (city) (state) (zip code) (country)

I declare under penalty of perjury that the foregoing is true and correct.

Executed in Hidalgo County, State of Texas, on the 19 day of April, 2018.
(month) (year)



Signature of authorized agent of contracting business entity (Declarant)

CERTIFICATE OF INTERESTED PARTIES

FORM 1295

1 of 1

Complete Nos. 1 - 4 and 6 if there are interested parties.
Complete Nos. 1, 2, 3, 5, and 6 if there are no interested parties.

**OFFICE USE ONLY
CERTIFICATION OF FILING**

1 Name of business entity filing form, and the city, state and country of the business entity's place of business.
Rio Valley Pipe, LLC d/b/a CAPA
Palmview, TX United States

Certificate Number:
2018-341679

Date Filed:
04/19/2018

2 Name of governmental entity or state agency that is a party to the contract for which the form is being filed.
Hidalgo County Purchasing Department

Date Acknowledged:
04/20/2018

3 Provide the identification number used by the governmental entity or state agency to track or identify the contract, and provide a description of the services, goods, or other property to be provided under the contract.
E-18-090
C-17-046-05-30 "Pipes & Related Miscellaneous Items - Hidalgo County

4	Name of Interested Party	City, State, Country (place of business)	Nature of interest (check applicable)	
			Controlling	Intermediary

5 Check only if there is NO Interested Party.

6 UNSWORN DECLARATION

My name is _____, and my date of birth is _____.

My address is _____, _____, _____, _____, _____.
(street) (city) (state) (zip code) (country)

I declare under penalty of perjury that the foregoing is true and correct.

Executed in _____ County, State of _____, on the _____ day of _____, 20____.
(month) (year)

Signature of authorized agent of contracting business entity
(Declarant)

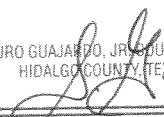
AT	4:13	FILED	O'CLOCK	P	M
JUN 08 2017					
ARTURO GUAJARDO, JR. COUNTY CLERK HIDALGO COUNTY, TEXAS					
BY					DEPUTY

REQUIREMENTS AGREEMENT
C-17-046-05-30

THIS AGREEMENT (the "Agreement") is entered into effective as of the 30th day of May, 2017 by and between Rio Valley Pipe, LLC ("Seller") and Hidalgo County, Texas ("Buyer").

WHEREAS, Buyer has solicited sealed bids for the supply of its requirements of **Hidalgo County** for the "**Pipes and Misc. Items**," (the "Product") for **HIDALGO COUNTY**, as further described in Exhibit "A", Request for Bids (RFB) Procurement Packet as attached hereto and incorporated herein by reference for all purposes (the "RFB") for a period of **one (1) year** and;

WHEREAS, Seller has submitted a proposal to supply Buyer's requirements; and

WHEREAS, Buyer has determine that Seller has submitted the lowest and best bid to meet Buyer's requirements for certain of the Products, as herein after described.

NOW THEREFORE, for and in consideration of the mutual covenants and conditions hereinafter set forth, and other good and valuable consideration, the receipt and sufficiency of which is hereby acknowledged, the parties hereto agree as follows:

1. Buyer agrees to purchase from Seller, and Seller agrees to sell and deliver to Buyer, all of the Products listed on Exhibit "B", which is attached hereto and incorporated herein by reference, that Buyer may require for use by Buyer in Hidalgo County projects for a period of a **one (1) year** with the County's option to extend/renew for an additional one (1) year period under the same rates, terms and conditions. Hidalgo County reserves the right to continue this bid for an additional sixty (60) day grace period, under the same rates, terms and conditions at the end of the contract term for unforeseen delays in award of new bid for the next contract term. This Contract shall commence on **June 30, 2017** and expire on **June 29, 2018** and it is agreed that the Products will meet the Specifications in the Request for Bids (RFB) Procurement Packet set forth in Exhibit "A" hereto.

2. When Buyer determines that it needs a quantity of the Products to be delivered, it will, according to its Purchasing Policies, complete and submit to Seller a Purchase Order describing the type and quantity of the Products required. The Products are to be delivered by Seller to the location in Hidalgo County specified by Buyer in its Purchase Order.

3. Buyer agrees to pay Seller for each Purchase Order based on the prices set out in Exhibit "B". Seller shall render invoices for each Purchase Order, and the invoices shall be paid by Buyer on or before the 30th day following receipt of the invoice.

4. General Provisions.

a. **Conflict with Applicable Law.** Nothing in this Agreement shall be

construed so as to require the commission of any act contrary to law, and whenever there is any conflict between any provision of this Agreement and any present or future law, ordinance or administrative, executive or judicial regulation, order or decree, or amendment thereof, contrary to which the parties have no legal right to contract, the latter shall prevail, but in such event the affected provision or provisions of this Agreement shall be modified only to the extent necessary to bring them within the legal requirements and only during the time such conflict exists.

b. **No Waiver.** No waiver by Buyer of any breach of any provision of this Agreement shall be deemed to be a waiver of any preceding or succeeding breach of the same or any other provision hereof.

c. **Entire Agreement.** This Agreement contains the entire contract between the parties hereto, and each party acknowledges that neither has made (either directly or through any agent or representative) any representations or agreements in connection with this Agreement not specifically set forth herein. This Agreement may be modified or amended only by agreement in writing executed by Buyer and Seller, and not otherwise.

d. **Texas Law to Apply.** This Agreement shall be construed under and in accordance with the laws of the State of Texas, and all obligations of the parties created hereunder are performable in Hidalgo County, Texas. The parties hereby consent to personal jurisdiction in Hidalgo County, Texas.

e. **Notice.** Except as may be otherwise specifically provided in this Agreement, all notices, demands, requests or communications required or permitted hereunder shall be in writing and shall either be (i) personally delivered against a written receipt, or (ii) sent by registered or certified mail, return receipt requested, postage prepaid and addressed to the parties at the addresses set forth below, or at such other addresses as may have been theretofore specified by written notice delivered in accordance herewith:

If to Buyer: Hidalgo County
Attention: County Judge
1615 South Closner, Suite J
Edinburg, Texas 78539

If to Seller: Rio Valley Pipe
Attention: Larry Hinojosa, Sales Administrator
3609 W. Palma Vista Drive
Palmview, Texas 78572

Each notice, demand, request or communication which shall be delivered or mailed in the manner described above shall be deemed sufficiently given for all purposes at such time as it is personally delivered to the addressee or, if mailed, at such time as it is deposited in the United States mail.

f. **Termination.** Buyer may terminate this Agreement at any time for any reason or no reason at all upon giving thirty (30) days written notice.

g. **Additional Documents.** The parties hereto covenant and agree that they will execute such other and further instruments and documents as are or may become necessary or convenient to effectuate and carry out the terms of this Agreement.

h. **Successors.** This Agreement shall be binding upon and inure to the benefit of the parties hereto and their respective heirs, executors, administrators, legal representatives, successors, and assigns where permitted by this Agreement.

i. **Assignment.** This Agreement shall not be assignable.

j. **Headings.** The headings and captions contained in this Agreement are solely for convenient reference and shall not be deemed to affect the meaning or interpretation of any provision or paragraph hereof.

k. **Gender and Number.** All pronouns used in this Agreement shall include the other gender, whether used in the masculine, feminine or neuter gender, and the singular shall include the plural whenever and as often as may be appropriate.

l. **Authority to Execute.** The execution and performance of this Agreement by Buyer and Seller have been duly authorized by all necessary laws, resolutions or corporate action, and this Agreement constitutes the valid and enforceable obligations of Buyer and Seller in accordance with its terms.

m. **Insurance.** Seller shall provide, to the extent it deems necessary, insurance in force on all persons connected with providing services under this Contract naming Buyer as an additional insured, and shall furnish to Buyer certificates of such insurance coverage Exhibit "C", which is attached hereto.

n. **Commitment of Current Revenues Only.** In the event that, during any term hereof, the Commissioners Court of Buyer does not appropriate sufficient funds to meet the obligations of Buyer under this Agreement, Buyer may terminate this Agreement upon ninety (90) days written notice to Seller. Buyer agrees, however, to use reasonable efforts to secure funds necessary for the continued performance of this Agreement. The parties intend this provision to be a continuing right to terminate this Agreement at the expiration of each budget period of Buyer pursuant to the provisions of Tex. Loc. Govt. Code Ann. ' 271.903

(Vernon Supp. 1996).

o. **Purchasing Ethics.** Seller represents and warrants it has not, during the process of being awarded this contract violated the following ethical standards of Buyer and, upon and after the execution of this Agreement, agrees to abide by the following ethical standards of Buyer:

- (1) It shall be a breach of ethics to offer, give or agree to give any elected official, department head or employee, or former elected official, department head or employee, of Hidalgo County, or for any elected official, department head or employee or former elected official, department head or employee of Hidalgo County, to solicit, demand, accept or agree to accept from another person, entity or organization, a gratuity or an officer of employment in connection with any decision, approval, disapproval, recommendation, preparation or any part of a program requirement or purchase request, influencing the content of any specification or procurement standard, rendering of advise, investigation, auditing, or in any other advisory capacity in any proceeding or application, request for ruling, determination, claim or controversy, or other particular matter pertaining to any program requirement or a contract or subcontract, or to any solicitation or proposal therefore pending before any department or agency of Hidalgo County.
- (2) It shall be a breach of ethics for any payment, gratuity or offer of employment to be made by or on behalf of a subcontractor under a contract to the prime contractor or higher tier subcontractor for any contract for Hidalgo County, or any person associated therewith, as an inducement for the award of a subcontract or order.

p. **Immunities.** Nothing in this Agreement is intended to and Buyer does not hereby waive, release or relinquish any right to assert any of the defenses Buyer enjoys by virtue of the state or federal constitution, laws, rules or regulations, and any sovereign, official or qualified immunity available to Buyer as to any claim or action of any person, entity, or individual against Buyer.

EXECUTED effective as of the day and year first above written.

APPROVED AS TO FORM:
Atlas, Hall & Rodriguez, LLP

By: [Signature]
Stephen L. Crain

COUNTY OF HIDALGO

By: [Signature]
Ramon Garcia, County Judge

ATTEST:

[Signature]
Arturo Guajardo Jr., County Commissioner

APPROVED BY
COMMISSIONERS' COURT
ON: 8/30/17



RIO VALLEY PIPE LLC

By: [Signature]
Printed Name: Larry Ninojosa
Title: Sales Administrator

EXHIBIT "A"
REQUEST FOR SEALED BIDS (RFB) PROCUREMENT PACKET



Hidalgo County Purchasing Office
2812 S. Business Highway 281
Administration Building
Edinburg, Texas 78539
(956) 318-2626 / Fax: (956) 292-7612

March 20, 2017

Bidder's name

Address

City

State, Zip Code

Re: **HIDALGO COUNTY (All funding sources, programs & entities)**
Request for Bids - "Pipes & Related Miscellaneous Items"
RFB Bid No.: 2017-046-04-05-FAZ

Dear Gentleman/Ladies:

Enclosed, please find the Request for Bids (RFB) packet. **Modifications and new requirements** have been added and implemented. Carefully read and review all instructions, Requirements and Specifications.

Hidalgo County Purchasing Department welcomes and appreciates your participation in the Request for Bids process.

If any further assistance is required, please do not hesitate to call the Purchasing Department (956) 318-2626 x 4854.

Sincerely,

Martha L. Salazar, CPPB
Hidalgo County Purchasing Agent

MLS/faz
Enclosures



HIDALGO COUNTY PURCHASING OFFICE
2812 S. Business Highway 281
Administration Building
Edinburg, Texas 78539
(956) 318-2626 / Fax: (956) 292-7612

TABLE OF CONTENTS
REQUEST FOR BIDS (RFB)
HIDALGO COUNTY (All funding sources, programs & entities)
“Pipes & Related Miscellaneous Items”
RFB No.: 2017-046-04-05-FAZ

ITEM	DESCRIPTION	No. OF PAGES
1.	Request For Bid Letter	1
2.	Request for Bid, Legal Notice	8
3.	Exhibit A, Specifications	15
4.	Exhibit B, Bid Page	9
5.	Exhibit C, Insurance Requirements	4
6.	Exhibit D, (CIQ) Conflict of Interest Questionnaire (if applicable)	2
7.	Exhibit E, Vendor/Bidder Application and W-9 form(s)	6
8.	Exhibit F, Certification Regarding Debarment	1
9.	Exhibit G, Title VI Appendices “A” through “E”	6
10.	Draft Contract	8
11.	RFB Submittal Checklist	1

The above mentioned items shall be found in this Request for Bids-Goods/Products-RFB packet that is attached herewith. Should you find that any of the listed items are not attached in its entirety, please contact Purchasing by calling (956) 318-2626 or e-mail, to advise us of the missing documentation, and Purchasing will forward information either through facsimile, e-mail or by U.S. Mail.

Thank you.

Martha L. Salazar, CPPB, Purchasing Agent

3-10-16

Date

LEGAL NOTICE

REQUEST FOR BIDS

Hidalgo County

(All funding sources, programs & entities)

“Pipes & Related Miscellaneous Items”

RFB No.: 2017-046-04-05-FAZ

REQUEST FOR BIDS

HIDALGO COUNTY (All funding sources, programs & entities)

“Pipes & Related Miscellaneous Items”

BID OPENING DATE

APRIL 5, 2017

Contact Person:

Martha L. Salazar, CPPB, Purchasing Agent
Hidalgo County Purchasing Department
Physical Address: 2802 S. Business Hwy. 281 - Administration Building
Mailing/Postal Address: 2812 S. Business Hwy. 281
Edinburg, Texas 78539
(956) 318-2626



Form HCPD-03

1. Sealed bids will be received for **“HIDALGO COUNTY (All funding sources, programs & entities) - Pipes & Related Miscellaneous Items”** in accordance with the specifications attached as **Exhibit "A"** hereto. Bids should address all specifications set forth. Bidders may suggest substitutions of features which they feel would be in the best interest of Hidalgo County ("County"). Strong rationale must be presented for any deviation from the specifications. Hidalgo County reserves the right to reject the deviation and its effect on the overall bid.
2. **One (1) original and Three (3) copies** of all bids are required with the bidders name and return address clearly typed and or/printed on upper left hand corner and the proper notation clearly typed/printed on the lower left hand corner of the envelope and/or package: **BID No.: 2017-046-04-05-FAZ “HIDALGO COUNTY (All funding sources, programs & entities) - Pipes & Related Miscellaneous Items”** and at County's Purchasing Department with a physical address: 2802 S. Business 281 and a mailing address: 2812 S. Business Hwy 281, Administration Building, Edinburg, Texas, **on or before 9:30 A.M, WEDNESDAY, APRIL 5, 2017. NO FACSIMILES, EMAILS OR LATE ARRIVALS WILL BE ACCEPTED. ANY RFB RECEIVED AFTER THAT TIME WILL NOT BE OPENED AND WILL BE RETURNED. OVERNIGHT MAIL MUST ALSO BE PROPERLY LABELED ON THE OUTSIDE OF EXPRESS ENVELOPE OR PACKAGE WITH REFERENCE TO RFB No.: 2017-046-04-05-FAZ “HIDALGO COUNTY (All funding sources, programs & entities) - Pipes & Related Miscellaneous Items”** Hidalgo County reserves the right to refuse and reject any/all bids and to waive any/all formalities or technicalities, or to accept the bids considered the best and most advantageous to Hidalgo County.

Additionally, all forms listed below must be properly executed and included with your bid:

1. Legal Notice (See page 8);
 2. Bid Page – Procurement Form – Areas of Specialization (See **Exhibit “B”**);
 3. Insurance pages with Acknowledgment Forms (See **Exhibit “C”**);
 4. Form CIQ-Conflict of Interest Questionnaire (See **Exhibit “D”**);
 5. Vendor Bidder Application & W-9 forms (See **Exhibit “E”**);
 6. Certification Regarding Debarment (See **Exhibit “F”**); and
 7. SAMS.gov Registration Acknowledgement (See Number 18 below).
3. Hidalgo County reserves the right to: A. separate and accept, or eliminate any item(s) listed under this bid that it deems necessary to accommodate budgetary and/or operational requirements; B. reject any or all bids submitted and further reserves the right to design the evaluation criteria to be used in selecting the lowest and best bid for approval; C. award the bid to one bidder or to multiple bidders if the County determines it is in its best interest to do so; D. award the contract to the responsible bidder who submits the lowest and best bid. "Lowest and best" means a bid or offer providing the best value considering associated direct and indirect costs, including transport, maintenance, reliability, and life cycle, warranties, and customer service after a sale.
 4. The Bidder shall not substitute items named in the bid without the express written consent of Hidalgo County. Failure of the delivered item to perform as specified or failure to meet the stated delivery schedule shall release Hidalgo County from all obligations to the contracting party with regard to the item(s) in question. In such event, County may elect to award the contract to the next-lowest responsible bidder, or to reject all bids and re-advertise.
 5. For work to be performed at a County owned or operated location, each bidder shall, in its sole discretion, visit the job site before preparing the bid and thoroughly familiarize himself/herself with existing conditions. Bidder should take field dimensions and note all circumstances which affect the dollar amount of the bid.

6. Descriptive specifications are referenced in this document to indicate the general kind and quality of equipment desired by Hidalgo County. Due to various styles and models of equipment, bidders are required to include illustrations, specifications, explanation of warranties, and service data with their bid including catalogue numbers and any necessary references.
7. No bid may be withdrawn within thirty (30) days from the scheduled time to open bids.
8. Proposed prices are to remain firm for a minimum of ninety (90) days after bid opening.
9. Any interpretations, amendments, corrections or changes to this bid document must be in a written addendum and signed by the County Judge or his designee. Addenda will be mailed to all who are known to have received a copy of the Request for Bids. Bidders shall acknowledge receipt of all addenda as a part of their bid.
10. County reserves the right to accept or reject any or all Bids.
11. Costs are to be net F.O.B., County Prepaid.
12. County is exempt from Federal Excise Tax, State Tax and Local Tax. Do Not include tax in cost figure. If it is determined that tax was included in the cost figures it will not be included in the tabulation of any awards. Tax exemption certificates will be furnished upon request.
13. Funds for this procurement have been provided through the County budget for this fiscal year only. County, on an annual basis, has the right to reconsider a contract during the budget process for ensuing years if financial resources of County are insufficient to meet the liabilities of said contract. The award of a bid or contract hereunder will not be construed to create a debt of the County which is payable out of funds beyond the current fiscal year.
14. Upon award and prior to execution of a contract, Sole Proprietorships are required to submit a copy of their social security cards to the Hidalgo County Auditor's Office in order to establish an account with the County. All awarded vendors must submit a completed W-9 and a copy of their Federal ID Number Certificate.
15. DELIVERY INSTRUCTIONS:
 - . No deliveries accepted after 3:00 P.M., Monday-Friday.
 - . At least seventy two (72) hours prior notice of delivery must be given to Martha L. Salazar, Purchasing Agent before delivery will be accepted.
 - . If you need additional information call the office listed below:

Hidalgo County Purchasing Department
Martha L. Salazar, Purchasing Agent
(956) 318-2626
16. BILLING AND PAYMENT INSTRUCTIONS:
 - . Invoices must include:
 - a) Name and address of successful bidder
 - b) Name and address of receiving department or official
 - c) Purchase Order Number (if any)
 - d) Notation - "HIDALGO COUNTY (All funding sources, programs & entities) -RFB No.: 2017-046-04-05-FAZ "Pipes & Related Miscellaneous Items"

Descriptive information as to the items or services delivered, including product code, item number, quantity, etc.

e) Contract number must be indicated on all invoices

- . Discount payments will be considered when offered.
- . Contact person for Billing and Payment questions:

Hidalgo County Auditor's Office
 2808 S. Business Hwy 281
 Edinburg, TX 78539
 (956) 318-2511

17. SCHEDULE OF EVENTS

Bid Opening, 9:30 A.M.	<u>APRIL 5, 2017</u>
Award of Contract	<u> , 2017</u>
Commence Work or Deliver Products	<u> , 2017</u>

18. BID OR PERFORMANCE BOND AND DEBARMENT CERTIFICATION; PAYMENT UNDER CONTRACT:

. If the contract proposed is for the construction of public works or is for a contract for goods & services exceeding \$100,000, all bidders shall furnish a good and sufficient bid bond in the amount of five percent of the total contract price. A bid bond must be executed with a surety company authorized to do business in Texas. All bidders are also required to furnish a certification or acknowledgment stating that the contractor or vendor is free from suspension or debarment pursuant to federal regulation 45CFR Part 76. Register at SAMs System for Award Management @ www.sam.gov.

. Together with the signing of a contract or issuance of a purchase order following the acceptance of a bid, and prior to commencement of the actual work, the bidder shall furnish a performance bond to the County for the full amount of the contract, if that contract exceeds \$50,000.

. If the contract is for \$50,000 or less, no money will be paid to the contractor until completion and acceptance of the work or the fulfillment of the purchase obligation to the County, and, if applicable, the receipt by County of satisfactory evidence that all subcontractors and material men have been paid.

. If a contract is for the construction, alteration or repair of public buildings or public works, the contractor *shall* provide a payment bond for a contract in excess of Twenty Five Thousand Dollars (\$25,000.00), as required by Tex. Govt. Code Ch. 2253.

For requirements contracts, bond requirements are determined by applying the proposed unit price to the estimated quantities included in the specifications.

19. TITLE VI NOTICE/ NONDISCRIMINATION

a. "The County of Hidalgo, in accordance with the provisions of Title VI of the Civil Rights Act of 1964 (78 Stat.252, 42 U.S.C. §§2000d to 2000d-4) and the Regulations, hereby notifies all bidders that it will affirmatively ensure that any contract entered into pursuant to this advertisement, disadvantaged business enterprises will be afforded full and fair opportunity to submit bids in response to this invitation and will not be discriminated against on the grounds of race, color, or national origin in consideration for an award."

b. The appropriate clauses of Appendices "A" through "E" as delineated in the USDOT Standard Title VI/Nondiscrimination Assurances - Specific Assurances are hereby incorporated by reference as applicable. Title VI Appendices "A" through "E" are attached as **Exhibit "G"**.

c. Bidder will attach all applicable notices to which it is obligated to provide or submit as part of the bid, including Form FHWA 1273 to be submitted by all contractors and subcontractors in relation to construction contracts.

20. ETHICAL STANDARDS:

. It shall be a breach of ethics to offer, give or agree to give any elected official, department head or employee, or former elected official, department head or employee, of the County, or for any elected official, department head or employee or former elected official, department head or employee of the County, to solicit, demand, accept or agree to accept from another person, entity or organization, a gratuity or an offer of employment in connection with any decision, approval, disapproval, recommendation, preparation or any part of a program requirement or purchase request, influencing the content of any specification or procurement standard, rendering of advice, investigation, auditing, or in any other advisory capacity in any proceeding or application, request for ruling, determination, claim or controversy, or other particular matter pertaining to any program requirement or a contract or subcontract, or to any solicitation or proposal therefore pending before any department or agency of the County.

. It shall be a breach of ethics for any payment, gratuity or offer of employment to be made by or on behalf of a subcontractor under a contract to the prime contractor or higher tier subcontractor for any contract for the County, or any person associated therewith, as an inducement for the award of a subcontract or order.

. No public official shall have an interest in a contract awarded hereunder except in accordance with Tex. Loc. Govt. Code Chapter 171.

NOTICE:

ALL COMMUNICATIONS BY A VENDOR TO THE COUNTY, ITS OFFICIALS, AND DEPARTMENT HEADS REGARDING THIS PROCUREMENT SHALL BE DONE THROUGH THE HIDALGO COUNTY PURCHASING DEPARTMENT.

21. DISCLOSURE OF CONFLICT OF INTEREST

. Effective January 1, 2016, Chapter 176 of the Texas Local Government Code requires that any vendor, person, consultant or contractor considering doing business with Hidalgo County ("the County") to disclose in the Conflict of Interest Questionnaire (the "CIQ") attached as Exhibit E, the vendor, person, consultant or contractor's affiliation or business relationship that might cause a conflict of interest with the County. By law, the CIQ must be filed with the Hidalgo County Clerk's Office no later than the seventh business day after the date the person becomes aware of facts that require that statement to be filed. The disclosure requirement applies to a person or business who contracts or seeks to contract with Hidalgo County for the

sale or purchase of property, goods or service. Any purchase order or contract resulting from this process shall be considered null and void if the successful bidder fails to comply with Texas Local Government Code Chapter 176. Vendors, consultants, contractors and others who desire to conduct business with Hidalgo County are encouraged to refer to Texas Local Government Code Chapter 176 for the details of this law. An offense under Texas Local Government Code Chapter 176 is a Class C Misdemeanor.

Completed Form CIQ must be submitted to the Hidalgo County Clerk's Office located at 100 N. Closer, Edinburg, Texas 78539 - Hidalgo County Courthouse.

COMPLETION AND SUBMISSION OF FORM CIQ IS THE SOLE RESPONSIBILITY OF THE PROSPECTIVE RESPONDENT. QUESTIONS REGARDING COMPLIANCE SHOULD BE DIRECTED TO YOUR LEGAL COUNSEL.

22. CERTIFICATE OF INTERESTED PARTIES (FORM HB1295)

As of January 1, 2016, to comply with Texas Government Code Section §2252.908, and the rules issued by the Texas Ethics Commission found in Title 1, Section 46.1, 46.3 and 46.5 of the Texas Administrative Code, we have updated and revised our RFB packet. In accordance with these requirements, business must submit a completed Certificate of Interested Parties Form 1295 to the County before the County may enter into a contract with the business entity. In box 3 of Form 1295, you will provide the RFB Project No. (2017-046), as shown on the packet. Once completed and filed with the Texas Ethics Commission, Form 1295 must be printed and signed in the presence of a notary and submitted to our office either by facsimile transmission to (956) 292-7612 or via email to: matilde.faz@co.hidalgo.tx.us. Hidalgo County cannot enter into a contract until Form 1295 is submitted. Therefore, failure to timely submit Form 1295 signed and notarized may result in delay of award. Full instructions for completion and submittal of Form 1295 may be found on the Texas Ethics Commission website:

<https://www.ethics.state.tx.us/tec/1295-Info.htm>

THE AWARDED VENDOR WILL HAVE THIRTY (30) DAYS FROM THE DATE THE HIDALGO COUNTY COMMISSIONER'S COURT APPROVES THIS AGREEMENT TO SUBMIT THE SIGNED NOTARIZED FORM 1295. *HIDALGO COUNTY CANNOT ENTER INTO A CONTRACT UNTIL FORM 1295 IS SUBMITTED.*

23. If, during the life of any contract or bid awarded, the successful bidder's net prices generally available to other customers for items awarded herein are reduced below the contracted price, it is understood and agreed that the benefits of such reduction shall be extended to the County.
24. Bids, and all goods and services provided hereunder, shall comply with all federal, state and local laws concerning this type(s) of goods and/or services.
25. Minimum Standards for Responsible Prospective Bidders: A prospective bidder must affirmatively demonstrate bidder's responsibility. A prospective bidder, by submitting a bid, represents to County that it meets the following requirements:
- . Possess or is able to obtain adequate financial resources as required to perform under the bid;
 - . Be able to comply with the required or proposed delivery schedule;
 - . Have a satisfactory record of performance;
 - . Have a satisfactory record of integrity and ethics;
 - . Be otherwise qualified and eligible to receive an award.
26. Successful bidder will pay or cause to be paid, without cost or expenses to County, all FICA, FUTA/SUTA and Federal Income Withholding Taxes of all employees, and all wages and benefits as required by Federal or State law. Successful bidder's officers, agents and/or employees will not be entitled to any benefits of an employee or elected official of County, including, but not limited to, benefits associated with County's civil service system.

27. Any contract award to a successful bidder will be in effect until (a) the contract expires, (b) delivery and acceptance of products, and/or performance of services ordered, or (c) terminated by County with thirty day's written notice prior to cancellation.
28. County reserves the right to enforce performance of any contract awarded hereunder in any manner prescribed by law or deemed to be in the best interest of the County in the event of breach or default by successful bidder; County reserves the right to terminate any contract immediately in the event a successful bidder fails to:
 - A. Meet schedules;
 - B. Pay any required fees or taxes; or
 - C. Otherwise perform in accordance with the specifications.
29. Successful bidder shall defend, indemnify and save harmless County and all its elected officials, officers, agents and employees from all suits, actions, or other claims of any character, name and description brought for or on account of any injuries or damages received or sustained by any person, persons, or property on account of any negligent act or fault of the successful bidder, or of any agent, employee, subcontractor or supplier of successful bidder in the execution of, or performance under, any contract which may result from bid award or which arises from any event or casualty happening on or within County premises themselves or happening upon or in any halls, elevators, entrances, stairways or approaches of or to such County facilities. Successful bidder shall pay any judgment with costs which may be obtained against county growing out of such injury or damages, and shall, upon request, provide a defense to County by counsel reasonably acceptable to County. Successful bidder's indemnity hereunder shall include, but is not limited to, claims relating to patent, copyright or trademark infringement, and the like, arising out of the goods and services provided by successful bidder.
30. Successful bidder shall warrant that all items/services shall conform to the specifications and/or all warranties provided under the Uniform Commercial Code and be free from all defects in material, workmanship and the like. Items supplied under a contract pursuant to this Request for Bids shall be subject to County's approval. Items found to be defective or not meeting specifications shall be replaced by successful bidder within two business days at no expense to County. Items not picked up within one (1) week after notification shall be deemed a donation to County and may be used or disposed of at County's discretion and without waiver of any other rights of County as to the item's nonconformity.
31. This document and any disputes arising hereunder shall be governed and construed according to the laws of the State of Texas, and will be performable exclusively in Hidalgo County, Texas.
32. The successful bidder shall not assign, sell, transfer or convey its rights under any awarded contract, in whole or in part, without the prior written consent of County.

LEGAL NOTICE

Bid

For

HIDALGO COUNTY (All funding sources, programs & entities)

"Pipes & Related Miscellaneous Items"

BID No.: 2017-046-04-05-FAZ

To: Martha L. Salazar, CPPB, Purchasing Agent
Physical Address: 2802 S. Business Hwy. 281 - Administration Building
Mailing/Postal Address: 2812 S. Business Hwy. 281
Edinburg, Texas 78539

In accordance with the Specifications, and subject to all laws and regulations of the United States and state and local laws, the undersigned bidder proposes and commits to furnish all labor, equipment, material, software and services as set forth in the documents hereinbefore mentioned. The undersigned bidder further agrees, upon acceptance of its bid, to execute a contract and/or Purchase Order issued by Hidalgo County for performing and completing the work described in the Specifications within the time stated and for the prices proposed in the documents attached hereto and made a part hereof.

Bidder acknowledges receipt of all of the pages of the documents referenced in the Invitation to Bid Checklist presented in connection with this procurement. Bidder understands that Hidalgo County reserves the right to reject any or all bids and further reserves the right to design the evaluation criteria to be used in selecting the lowest and best bid.

Bidder agrees that this bid shall be good and may not be withdrawn for a period of ninety (90) calendar days after the scheduled closing time for receiving bids, as contained in the Specifications.

Respectfully submitted,

Bidder:

Address:

By:

Printed Name:

Title:

EXHIBIT “A”
SPECIFICATIONS/REQUIREMENTS

REQUEST FOR BIDS

Hidalgo County

(All funding sources, programs & entities)

“Pipes & Related Miscellaneous Items”

RFB No.: 2017-046-04-05-FAZ

EXHIBIT "A"
SPECIFICATIONS
HIDALGO COUNTY (All funding sources, programs & entities)
"PIPES & Related Miscellaneous Items"
RFB No.: 2017-046-04-05-FAZ

SPECIFICATIONS AND/OR REQUIREMENTS:

Bidder(s) shall supply, where needed (on an "as needed" basis) in Hidalgo County or job site, "PIPES, Inlets, Manholes & Miscellaneous Items".

Bid information will be furnished to all Hidalgo County departments requiring pipes and delivery will involve numerous locations within Hidalgo County.

I. LOCATIONS – Departments requiring pipes.

II. DELIVERY INSTRUCTIONS

Delivery hours will be arranged with each department requiring pipes. Bidder(s) shall deliver the amount of product requested to location or job site required within 24 hours, or earlier, if requested. Bidder(s) agree(s) that, to the extent an item is unavailable from bidder's own inventory; bidder(s) will be responsible for locating an alternative supplier and for providing the product to Hidalgo County for the bid price. VENDOR(S) MUST UNLOAD ANY/ALL ITEMS LISTED AT THE REQUESTED SITE(S).

III. BID AWARD

1. Hidalgo County may award the bid on a lump sum basis to one (1) bidder or to multiple bidders on an item by item basis in each category, whichever is in the best interest of the County. For evaluation and consideration of items bid, samples will be submitted upon request. Categories will be as follows:

- Category A: Pipes
- Category B: Inlets
- Category C: Manholes
- Category D: Miscellaneous

CATEGORY (A) – PIPES
CORRUGATED PVC STORM SEWER PIPE SPECIFICATION

1.0 SCOPE:

Polyvinyl chloride (PVC) storm sewer/drain pipe and fitting shall be manufactured and tested in accordance with AASHTO Specifications M304.

2.0 MATERIAL AND DESIGN

The structural design of thermoplastic pipes shall be in accordance with AASHTO Standard Specifications for Highway Bridge; Section 8 titled "Soil-Thermoplastic Pipe Interaction Systems". To ensure long-term design strength properties, PVC Pipe shall be manufactured from 12454B or 12454C cell class material per ASTM D1784.

3.0 JOINING SYSTEM:

Joints may be either plastic sleeve with gaskets or an integral bell-gasket joint. When the joint is assembled, it shall prevent misalignment of adjacent pipes and form either a soil (2 psi hydrostatic test per AASHTO Standard Specifications for Highway Bridges: Section 26.4.2.4) or watertight joint (10.8 psi test per ASTM D3212 "Standard Specifications for Joints for Drain and Sewer Plastic Pipes Using Flexible Elastomeric Seals" as required.

4.0 INSTALLATION

PVC thermoplastic pipe and fittings manufactured to these specifications shall be installed in accordance with ASTM D2321-89.

EXHIBIT "A"
 SPECIFICATIONS
 HIDALGO COUNTY (All funding sources, programs & entities)
 "PIPES & Related Miscellaneous Items"
 RFB No.: 2017-046-04-05-FAZ

Heights of Cover

DIAMETER	CORRUGATED PVC PIPE (AASHTO M304)
INCHES	FEET
12	49
15	47
18	51
24	50
30	50

*Minimum cover (H-20 live load) = (ASTM D2321 with Class A1 embedment)

CORRUGATED STEEL STORM SEWER PIPE SPECIFICATIONS

1.0 GENERAL

This item shall govern the furnishings of corrugated steel pipe and pipe-arch for culverts and storm sewer for the types, sizes and designations as specified in these specifications.

2.0 MATERIALS

This pipe shall be fabricated from sheets conforming to the current AASHTO M-274 (ASTM A819) specification for ALUMINIZED STEEL Type 2 material or the current AASHTO M-246 (ASTM 742) specification for POLYMER coated galvanized steel material.

3.0 MANUFACTURE

This pipe shall meet the requirements of AASHTO M-36 (ASTM A760) for corrugated steel pipe. All pipe shall be manufactured with a minimum of two-re-rolled annular ends.

4.0 CLASSIFICATION (TYPE) FOR DIAMETERS 46" THROUGH 96"

This pipe shall be manufactured to conform to the current AASHTO M-36 (ASTM A 760) specification and shall have an extended helical corrugation pattern of $\frac{3}{4}$ x $\frac{3}{4}$ " 7 $\frac{1}{2}$ " as described in AASHTO M-36 (ASTM A 760).

All round pipe shall be manufactured to conform to the current AASHTO M 245 (ASTM A 762 & A 760) specification and shall have a full circular cross section with a smooth steel liner and helically corrugated shell, integrally attached at helical lock seams. All round pipe shall conform to the Type IA pipe classification. All pipe arches shall conform to the Type IIA classification.

Type I pipe classifications will also be considered. These pipes shall be manufactured out of ALUMINIZED STEEL Type 2 or POLYMER coated galvanized steel as referenced above.

5.0 POST APPLIED COATING

All Pipes manufactured with ALUMINIZED STEEL Type 2 shall be fully coated both inside and out with a minimum thickness of 0.05 in. (1.3 mm) measured from the crest of the corrugations, on the top of ribs, (as in Type IR pipe) or on the smooth inside surface of the pipe. The coating shall be uniform Class B (bituminous) or Class M (mastic) material as described in AASHTO M-190 (ASTM A 849).

6.0 GAUGE

Unless otherwise specified on the specifications, gauges shall be minimum as follows:

TYPE IR (SPIRAL CORRUGATION)	
DIAMETER	GAUGE
36-48"	16
54-60"	14
66-96"	12
TYPE I (STANDARD)	
54-138"	12
144"	10
All Types IA shall be 12 gauge shell and 18 gauge liner.	

EXHIBIT "A"
SPECIFICATIONS
HIDALGO COUNTY (All funding sources, programs & entities)
"PIPES & Related Miscellaneous Items"
RFB No.: 2017-046-04-05-FAZ

7.0 COUPLING BANDS

Coupling bands shall be of the same base material and coating as the pipe. Coupling bands shall lap evenly on each of the pipes being connected and shall fit securely into at least one full circumferential corrugation to form a tightly closed joint.

All pipes shall be field jointed with corrugated locking bands. Connecting bands shall be drawn together by means of not less than two bolts not less than ½ in. (13 mm) diameter through angles or bar and strap device suitable welded or riveted.

Coupling bands shall be no more than three normal sheet thickness lighter than the pipe to be connected and in no case thinner than 0.052 in. (1.32 mm).

8.0 INSTALLATION

Corrugated steel pipe shall be installed as outlined in AASHTO Standard Specifications for Highway Bridges, Section 26 and ASTM A798.

9.0 MEASUREMENT

Corrugated steel pipe will be measured by linear foot. Such measurements shall be made between the ends of the barrel along its central axis. Where spurs or branches, or connections to existing pipe lines are involved, measurements of the spur or new connecting pipe will be made from the intersection of the central axis with the outside surface of the pipe into which it connects. Where inlets, headwalls, catch basins, manholes, junction chambers or other structures are included in lines of pipe that length of pipe tying into the other structure wall will be included for measurement but no other portion of the structure length or width will be included.

For multiple pipes, the measured length will be the sum of the lengths of the barrels, measured as prescribed above.

In the event of a change in design which either increases or decreases the quantity of pipe, the variation in quantity will be measured as prescribed above and the quantity shown in the specifications will be increased or decreased as the case may be.

10.0 PAYMENT

Payment for corrugated steel pipe, measured as prescribed above will be made at the contract unit price bid per linear foot for various sizes, gauges and types of corrugated steel pipe.

Payments shall be full compensation for furnishings, transporting and installing the pipe. This includes materials, labor, equipment, tools and incidentals necessary to complete the installation in accordance to these specifications.

EXHIBIT "A"
 SPECIFICATIONS
 HIDALGO COUNTY (All funding sources, programs & entities)
 "PIPES & Related Miscellaneous Items"
 RFB No.: 2017-046-04-05-FAZ

CATEGORY (A) – PIPES
REINFORCED CONCRETE PIPE - GASKET JOINT PIPE SPECIFICATIONS

REINFORCED CONCRETE PIPE - GASKET JOINT PIPE SPECIFICATIONS						
CLASS III - ASTM C76 STANDARDS						
PIPE I.D.	WALL THICKNESS	CONCRETE STRENGTH	CAGE			PIPE WEIGHT
(in)	(in)	(PSI)	TYPE	INNER	OUTER	(LBS)
15	3.00	4,000	SINGLE	3"x6"-W1.75/W2.5		1,520
18	3.25					1,920
24	3.75					2,840
30	4.25					4,020
36	4.75		DOUBLE		3"x6"-W1.75/W2.5	5,520
42	5.25					7,100
48	5.75					8,280
54	6.25					9,800
60	6.75					12,184
72	7.75					15,900

REINFORCED CONCRETE PIPE - GASKET JOINT PIPE SPECIFICATIONS						
CLASS IV - ASTM C76 STANDARDS						
PIPE I.D.	WALL THICKNESS	CONCRETE STRENGTH	CAGE			PIPE WEIGHT
(in)	(in)	(PSI)	TYPE	INNER	OUTER	(LBS)
15	3.00	4,000	SINGLE	3"x6"-W2.5/W2.5		1,520
18	3.25					1,920
24	3.75					2,840
30	4.25		DOUBLE		3"x6"-W2.0/W2.0	4,020
36	4.75					5,520
42	5.25					7,100
48	5.75	8,280				
54	6.25	9,800				
60	6.75	5,000				
72	7.75		15,900			

EXHIBIT "A"
 SPECIFICATIONS
 HIDALGO COUNTY (All funding sources, programs & entities)
 "PIPES & Related Miscellaneous Items"
 RFB No.: 2017-046-04-05-FAZ

REINFORCED CONCRETE PIPE - GASKET JOINT PIPE SPECIFICATIONS							
CLASS V - ASTM C76 STANDARDS							
PIPE I.D. (in)	WALL THICKNESS (in)	CONCRETE STRENGTH (PSI)	CAGE			PIPE WEIGHT (LBS)	
			TYPE	INNER	OUTER		
15	3.00	6,000	SINGLE	3"x6"-W2.5/W2.5		1,520	
18	3.25					1,920	
24	3.75		DOUBLE		3"x6"-W3.0/W2.5	3"x6"-W2.5/W2.5	2,840
30	4.25						4,020
36	4.75						5,520
42	5.25						7,100
48	5.75						8,280
54	6.25						9,800
60	6.75						12,184
72	7.75						15,900

General Note:

1. Concrete gasket pipe shall meet Bureau of Reclamation R-4 Joint O-Ring gasket ASTM C361 Standards and price quote shall be included with the pipes.
2. All welded Wire Fabric Steel shall meet ASTM 82 and ASTM 185 Standards.
3. Aggregates shall meet ASTM C 33 Standards.
4. Fly Ash shall meet ASTM C 618-97 Standards.
5. Type II Cement shall meet ASTM C 150 Standards.
6. The maximum lengths of pipe sections shall be 8 feet.

The following are the technical requirements for the Reinforced Gasket Joint Concrete Pipe ASTM C-76 Class III.

D.1 GENERAL:

Pipe shall be manufactured and tested according to ASTM Designation: C-361 except as hereinafter changed and further specified. The requirements for cement, admixture, concrete strength, wall thickness, joints, manufacture and handling of pipe shall be in accordance with Paragraphs C-2, C-3, C-4, C-5, C-6, C-7, C-8, C-10, C-11, C-12, C-13 and C-14, respectively.

D.2 STEEL REINFORCEMENTS:

The reinforcing steel shall conform to requirements of Class III reinforced pipe, ASTM Designation: C-76. Reinforcements may be circular or elliptical.

D-3 PHYSICAL TEST REQUIREMENTS:

The test for internal hydrostatic pressure on the pipe shall not be less than that shown in Table "A" Paragraph C-10 thereof. The test for minimum 3-edge bearing load (pounds per linear foot) shall not be less than that required for Class III reinforced concrete pipe, ASTM Designation C-76.

RELATED PARAGRAPHS C-2 CEMENT:

The cement shall be Type II, low alkali in accordance with Federal Specifications SS-C 1960/3. The Contractor shall furnish certificates from the mill manufacturing the cement evidencing compliance with these specifications.

C-3 ADMIXTURE:

All concrete in concrete pipe placed by the placing and vibrated method shall have air-entraining agent conforming to ASTM Designations: C260. The amount of air-entraining agent used shall be such as will effect the entrainment of 2-1/2 ± 1 percent of air by volume, of the concrete as discharged from the mixer. Natural cement, slag cement, pozzolon or other mixtures shall not be added to the concrete without the written authorization of the Engineer in charge of the project.

EXHIBIT "A"
SPECIFICATIONS
HIDALGO COUNTY (All funding sources, programs & entities)
"PIPES & Related Miscellaneous Items"
RFB No.: 2017-046-04-05-FAZ

C-4 CONCRETE STRENGTH:

The strength requirements shall be 4,000 pounds per square inch in 28 days. The 4,000 PSI concrete test shall be in accordance with the latest edition of ASTM Designation: C-76.

C-5 CONCRETE MIXTURE:

The aggregate requirements of the latest ASTM Designation: C361 are changed to include, "the maximum size coarse aggregate shall be of the largest size practicable for placement considering the wall thickness of the pipe but shall not exceed 1-1/2 inches. The percentage of coarse aggregate to the total aggregate shall be as high as practicable for manufacture of the pipe".

C-6 CURING REQUIREMENTS:

The curing requirements in the latest edition of ASTM Designation: C361 are changed to include this additional requirement at the end of the paragraph: "If forms are stripped immediately after the pipe is cast and moved to the curing area, the concrete pipe shall not be lifted or tipped until a minimum concrete compressive strength of 2,500 PSI is attained. Determination of the required strength shall be accomplished by tests of concrete cylinders as described in the latest edition of ASTM Designation: C361".

C-7 WALL THICKNESS:

The thickness of the pipe wall shall be not less than that shown in Table A, Paragraph C-10, Physical Test Requirements", hereof.

C-8 PIPE LENGTHS:

The maximum lengths of pipe sections shall be 8 feet.

C-10 PHYSICAL TEST REQUIREMENTS:

The hydrostatic test pressures for the pipe and rubber gasket joint required in the latest edition of ASTM Designations 361 are changed to those specified in Table A. The Contractor shall also perform external load crushing strength test on the pipe. The external load crushing strength test shall be in accordance with the minimum three-edge bearing load as specified in Table A.

EXHIBIT "A"
 SPECIFICATIONS
 HIDALGO COUNTY (All funding sources, programs & entities)
 "PIPES & Related Miscellaneous Items"
 RFB No.: 2017-046-04-05-FAZ

TABLE A: PHYSICAL TEST REQUIREMENTS

Internal diameter (inches)	Minimum Shell Thickness (inches)	Internal Hydrostatic Pressure On Individual Section of Pipe (PSI)	Minimum 3-Edge Bearing Load (pounds per linear foot)
15	2	50	1,700
16	2	50	1,800
18	2	50	1,900
21	2 - 1/4	45	2,100
24	2 - 1/2	40	2,200
30	2 - 3/4	35	2,500
36	3	30	4,050
42	4 - 1/2	30	4,725
48	5	30	5,400
54	4 - 1/2	25	6,075
60	6	25	6,750
72	7	25	8,100

C-11 JOINTS:

Joints shall be made with round rubber gasket in conformance with the latest edition of ASTM Designation: C-361 and price quote shall be included with the pipes.

REINFORCED CONCRETE PIPE - TONGUE & GROOVE PIPE SPECIFICATIONS

REINFORCED CONCRETE PIPE - TONGUE & GROOVE PIPE SPECIFICATIONS								
CLASS III - ASTM C76 STANDARDS								
PIPE I.D.	WALL THICKNESS	CONCRETE STRENGTH	CAGE			PIPE WEIGHT		
(in)	(in)	(PSI)	TYPE	INNER	OUTER	(LBS)		
15	2.25	4,000	SINGLE	3"x6"-W1.75/W2.5		1,045		
18	2.50					1,400		
24	3.00					2,100		
30	3.50					3,050		
36	4.00					4,200		
42	5.25		DOUBLE	3"x8"-W3.0/W2.0	3"x6"-W1.75/W2.5	6,250		
48	5.75					3"x6"-W4.0/W2.5	3"x6"-W2.5/W2.5	8,100
54	6.25					3"x8"-W5.25/W2.5	3"x6"-W3.5/W2.5	9,420
60	6.75					2"x6"-W4.5/W2.5	3"x6"-W4.0/W2.5	11,500
72	7.75					2"x6"-W6.0/W2.5	3"x6"-W5.75/W3.0	15,900

EXHIBIT "A"
 SPECIFICATIONS
 HIDALGO COUNTY (All funding sources, programs & entities)
 "PIPES & Related Miscellaneous Items"
 RFB No.: 2017-046-04-05-FAZ

REINFORCED CONCRETE PIPE - TONGUE & GROOVE PIPE SPECIFICATIONS						
CLASS IV - ASTM C76 STANDARDS						
PIPE I.D. (in)	WALL THICKNESS (in)	CONCRETE STRENGTH (PSI)	CAGE			PIPE WEIGHT (LBS)
			TYPE	INNER	OUTER	
15	3.00	4,000	SINGLE	3"x6"-W2.5/W2.5		1,045
18	3.25			2"x6"-W2.5/W2.5		1,400
24	3.75			2"x6"-W4.5/W2.5		2,100
30	4.25			2"x8"-W6.0/W2.5		3,050
36	4.75		DOUBLE	2"x8"-W5.0/W3.0	3"x8"-W4.5/W2.5	4,200
42	5.25			3"x6"-W5.0/W2.5	3"x6"-W3.0/W2.5	6,250
48	5.75			3"x6"-W6.5/W3.0	3"x6"-W4.0/W2.5	8,100
54	6.25			2"x8"-W5.75/W3.0	3"x6"-W5.0/W2.5	9,420
60	6.75			2"x8"-W7.0/W3.0	3"x8"-W6.25/W3.0	11,500
72	7.75			2"x8"-W10.0/W4.0	2"x8"-W6.0/W2.5	15,900

REINFORCED CONCRETE PIPE - TONGUE & GROOVE PIPE SPECIFICATIONS						
CLASS V - ASTM C76 STANDARDS						
PIPE I.D. (in)	WALL THICKNESS (in)	CONCRETE STRENGTH (PSI)	CAGE			PIPE WEIGHT (LBS)
			TYPE	INNER	OUTER	
15	3.00	6,000	SINGLE	3"x6"-W3.5/W2.5		1,045
18	3.25			3"x8"-W4.75/W2.5		1,400
24	3.75			3"x8"-W6.0/W2.5		2,100
30	4.25		DOUBLE	2"x8"-W7.0/W3.0	3"x8"-W6.25/W3.0	3,050
36	4.75			2"x8"-W8.25/W3.5	2"x8"-W5.0/W3.0	4,200
42	5.25			2"x8"-W6.0/W2.5	3"x8"-W5.75/W3.0	6,250
48	5.75			2"x8"-W8.0/W3.5	3"x8"-W7.0/W3.0	8,100
54	6.25			2"x8"-W10.0/W4.0	2"x8"-W6.0/W2.5	9,420
60	6.75			2"x8"-W11.5/W4.5	2"x8"-W7.0/W3.0	11,500
72	7.75		2"x6"-W8.5/W6.5	2"x8"-W10.0/W4.0	15,900	

General Note:

1. All welded wire fabric steel shall meet ASTM 82 and ASTM 185 standards.
2. Aggregates shall meet ASTM C 33 standards.
3. Fly ash shall meet ASTM C 618-97 standards.
4. Type II cement shall meet ASTM C 150 standards.
5. Concrete joint sealant shall meet ASTM C 990 standards.
6. Concrete joint primer shall meet ASTM D 41 standards.
7. The maximum lengths of pipe sections shall be 8 feet.

REINFORCED POLYETHYLENE PIPE SPECIFICATIONS

SCOPE

This specification(s) describes reinforced polyethylene pipe for use in gravity flow storm drain and culvert applications in 24" through 96" nominal diameters.

DESCRIPTION

This pipe shall have a smooth waterway and exterior profile that is reinforced with high strength galvanized steel ribs. The continuous reinforcing ribs are completely encased within the polyethylene profile. Reinforced polyethylene pipe is manufactured using a helical winding process that results in continuously fusion welded circumferential lap seam. The pipe profile is manufactured using high pressure-rated thermoplastic meeting the requirements of ASTM F2562 "Standard Specification for Steel Reinforced Thermoplastic Ribbed Pipe and Fittings for Non-Pressure Drainage and Sewerage". For the purposes of hydraulic design, the recommended Manning's "n" value shall be 0.013 for pipe diameters included within this specification.

MATERIAL PROPERTIES

Virgin high density polyethylene pressure-related resins are used to manufacture reinforced polyethylene pipe and complimentary fabricated fittings. Resins shall conform to be minimum requirements of cell classification 345464 C as defined and described in the latest version of ASTM D3350 "Standard Specification for Polyethylene Plastic Pipe and Fittings Materials".

JOINT PERFORMANCE

Pipe lengths shall be joined on site using bell & spigots especially designed for reinforced polyethylene pipe. Both bell and spigot shall be reinforced with steel that is fully encased in pressure rated high density polyethylene meeting the requirements set forth in the above Material Properties paragraph and shall be watertight to an internal water pressure of 15 PSI when tested in accordance with ASTM D3212 "Standard Specification for Joints for Drain and Sewer Plastic Pipes Using Flexible Elastometric Seals".

FITTINGS

All fittings shall be fabricated from reinforced polyethylene pipe using fusion welded construction to ensure no loss of structural integrity of water-tightness at welded seams and joints.

INSTALLATION

Installation shall be in accordance with ASTM D2321 "Practice for Underground Installation of Thermoplastic Pipe for Sewers and Other Gravity-Flow Applications" along with product-specific recommendation by the manufacturer. Minimum cover shall be 1 ft. and maximum cover shall be 30 ft.

AWWA C900 PVC PLASTIC PRESSURE PIPE SPECIFICATIONS

SCOPE

This specification designates general requirements for 4" through 12" C.I.O.D.'s pipe produced in blue or white un-plasticized polyvinyl chloride (PVC) plastic pressure pipe with integral bell and spigot joints for the conveyance of water and other fluids. This pipe shall meet the requirements of AWWA Standard C900 "Polyvinyl Chloride (PVC) Water Distribution Pipe".

MATERIALS

All pipes shall be made from quality PVC resin, compounded to provide physical and mechanical properties that equal or exceed cell class 12454 as defined in ASTM D1784.

HYDROSTATIC PROOF TESTING

Each standard length of pipe is tested up to 400 psi for Pressure Class 165; 600 psi for Pressure Class 235; 800 psi for Pressure Class 305 for a minimum of 5 seconds. The integral bell shall be tested with the pipe.

STANDARD LAYING LENGTHS

Standard laying lengths are 20 feet for all sizes.

EXHIBIT "A"
 SPECIFICATIONS
 HIDALGO COUNTY (All funding sources, programs & entities)
 "PIPES & Related Miscellaneous Items"
 RFB No.: 2017-046-04-05-FAZ

PIPE

All pipes shall be suitable for use as pressure conduit. Provisions must be made for expansion and contraction at each joint with an elastomeric gasket. The bell shall consist of an integral wall section with a factory installed, solid cross section Rieber or other elastomeric gasket, which meets the requirements of ASTM F477. The bell section shall be designed to be at least as hydrostatically strong as the pipe barrel and meet the requirements of AWWA C900. The joint design shall meet the requirements of ASTM D3139 under both pressure and 22 in. Hg vacuum. Sizes and dimensions shall be as shown in this specification.

QUICK BURST TEST

Randomly selected samples testing in accordance with AWWA C900 and UL 1285 shall withstand, without failure, the pressures listed below when applied for 60-70 seconds.

DR	PRESSURE CLASS (psi)		MINIMUM BURST PRESSURE AT 73 F (psi)
	AWWA C900-97/FM 1612	AWWA C900-07	
25	100	165	535
18	150	235	755
14	200	305	985

DROP IMPACT TEST

Pipe shall withstand, without failure using Tup "B" and Flat Rate Holder "B", at 73 F, a tup impact energy of 100 ft-lbf for all Pressure Class of 4"-12" trade sizes. There shall be no visible evidence of shattering or splitting when the energy is imposed.

AWWA C905 PVC PLASTIC WATER PIPE SPECIFICATIONS

SCOPE

This specification designates general requirements for 14" through 48" un-plasticized polyvinyl chloride (PVC) plastic water pipe with integral bell and spigot joints for the conveyance of water and other fluids. This pipe shall meet AWWA C905 ANSI/NSF-61 and ANSI/UL 1285 (14" – 24").

MATERIALS

Pipe shall meet the requirements of AWWA Standard C905 "Polyvinyl Chloride (PVC) Water Transmission Pipe." All pipes shall be made from quality PVC resin, compounded to provide physical and mechanical properties that equal or exceed cell class 12454 as defined in ASTM D1784.

STANDARD LAYING LENGTHS

Standard laying lengths are 20 feet for all sizes.

PIPE

All pipes shall be suitable for use as pressure conduit. Provisions must be made for expansion and contraction at each joint with an elastomeric gasket. The bell shall consist of an integral wall section with a factory installed, solid cross section Rieber/other elastomeric gasket, which meets the requirements of ASTM F477. The bell section shall be designed to be at least as hydrostatically strong as the pipe barrel and meet the requirement of AWWA C905. The joint designs shall meet requirements of ASTM D3139, under both pressure and 22 in. Hg vacuum. Sizes and dimensions shall be as shown in this specification.

QUICK BURST TEST

Randomly selected samples tested in accordance with ANSI/UL 1285 shall withstand, without failure, the pressures listed below when applied for 60-70 seconds.

DR	PRESSURE RATING (psi)	MINIMUM BURST
18	235	755
25	165	535
32.5	125	400
41	100	315
51	80	255

EXHIBIT "A"
 SPECIFICATIONS
 HIDALGO COUNTY (All funding sources, programs & entities)
 "PIPES & Related Miscellaneous Items"
 RFB No.: 2017-046-04-05-FAZ

FLATTENING TEST

Specimens of pipe, a minimum of 6 in. (150 mm) long, shall be flattened between parallel plates in a suitable press until the distance between the plates is 40 percent of OD of the pipe. The rate of flattening shall be uniform and such that the compression is completed within 2 to 5 minutes. There shall be no evidence of splitting, cracking or breaking.

SDR 26 AND SDR 35 GASKETED GRAVITY SANITARY SEWER PIPE

PVC gravity sewer pipe shall be made from a compound conforming to a cell classification of 12454 or 12364 as defined by ASTM D1784 and in accordance with ASTM D3034 for sizes four inch through fifteen inch. The wall thickness, when tested according to ASTM D3412, shall correspond to a dimension ratio of SDR 35 with a pipe stiffness value of 46 or SDR 26 with a pipe stiffness of 115 for heavy wall pipe. Integral bells shall incorporate locked in gaskets meeting the requirements of ASTM D3212 and F477. The pipe shall be provided in lengths of 14 feet or 20 feet as required.

ASTM D3034 GASKETED GRAVITY SEWER PIPE

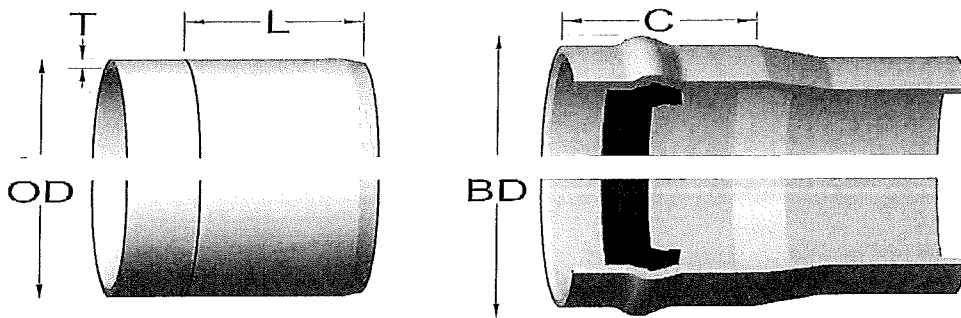

NOMINAL PIPE SIZE	OUTSIDE DIA. - NOM (OD)	*APPROX. BELL DIA. (BD)	**APPROX. BELL DEPTH (C)	INSERT MARK (L)
4"	4.215	5.25	3.75	3.13
6"	6.275	7.50	4.63	4.00
8"	8.400	10.00	5.25	4.13
10"	10.500	12.25	5.88	5.13
12"	12.500	14.25	6.50	5.38
15"	15.300	17.25	7.75	7.38

NOMINAL PIPE SIZE	SDR 35 (T)	SDR 26 (T)
4"	.120	.162
6"	.180	.241
8"	.240	.323
10"	.300	.404
12"	.360	.481
15"	.437	.588

HIGH PERFORMANCE (HP) POLYPROPYLENE STORM PIPE

1.0 SCOPE:

This specification includes materials and test methods for 12 to 60 inch diameter HP Polypropylene Pipe. The requirements of this specification are intended to provide pipe and fittings suitable for underground use in gravity-flow applications such as storm sewers, drainage and under-drains.

2.0 PIPE:

12 to 30 inch HP Polypropylene Pipe shall have a smooth interior and annular exterior corrugation and are required to meet or exceed ASTM F2736 and AASHTO M330. 36 to 60 inch pipe shall have a smooth interior and annular exterior corrugations and are required to meet or exceed ASTM F2881 and AASHTO M330. Pipe and fittings shall be homogeneous throughout and free from visible cracks, holes, foreign inclusions or other injurious defects.

EXHIBIT "A"
 SPECIFICATIONS
 HIDALGO COUNTY (All funding sources, programs & entities)
 "PIPES & Related Miscellaneous Items"
 RFB No.: 2017-046-04-05-FAZ

3.0 FITTINGS:

Fittings shall conform to ASTM F2736, ASTM F2881 and AASHTO M330, for the respective diameters. Bell & spigot connections shall utilize a spun-on, welded or integral bell and spigot with gaskets meeting ASTM F477. Bell & spigot fittings joint shall meet the watertight joint performance requirements of ASTM D3212. Corrugated couplings shall be split collar, engaging at least 2 full corrugations.

4.0 JOINTS:

HP Polypropylene Pipe shall be joined with a gasketed integral bell & spigot joint meeting the requirements of ASTM F2736 or F2881, for the respective diameters.

HP Polypropylene Pipe shall be watertight according to the requirements of ASTM D3212. Spigots shall have gaskets meeting the requirements of ASTM F477. Gasket shall be installed by the pipe manufacturer and covered with a removable, protective wrap to ensure the gasket is free from debris. A joint lubricant available from the manufacturer shall be used on the gasket and bell during assembly.

HP Polypropylene Pipe shall have a reinforced bell with a polymer composite band installed by the manufacturer.

5.0 MATERIAL PROPERTIES:

Polypropylene compound for pipe and fitting production shall be impact modified copolymer meeting the material requirements of ASTM F2736, Section 4, ASTM F2881, Section 5 and AASHTO M330, Section 6.1, for the respective diameters.

6.0 INSTALLATION:

Installation shall be in accordance with ASTM D2321, manufacturers recommended installation guidelines and plan specifications.

7.0 PIPE DIMENSIONS:

Nominal Pipe I.D. in (mm)	12 (300)	15 (375)	18 (450)	24 (600)	30 (750)	36 (900)	42 (1050)	48 (1200)	60 (1500)
Average Pipe I.D. In (mm)	12.1 (307)	14.9 (378)	18.0 (457)	24.1 (612)	30.1 (765)	35.7 (907)	41.8 (1062)	47.3 (1201)	59.3 (1506)
Average Pipe O.D. in (mm)	14.5 (368)	17.6 (447)	21.2 (538)	28.0 (711)	35.4 (899)	41.1 (1044)	47.2 (1199)	53.8 (1367)	66.5 (1689)
Minimum Pipe Stiffness * @ 5% Deflection* #/in./in. (kN/m²)	75 (520)	60 (411)	56 (385)	50 (343)	46 (320)	40 (275)	35 (240)	35 (240)	30 (205)

HIGH DENSITY POLYETHYLENE PIPE (HDPE)

SCOPE:

This specification describes 4- through 60 inch (100 to 1500 mm) HDPE pipe (per ASTM F2648) for use in gravity-flow land drainage applications.

PIPE Requirements:

HDPE pipe (per ASTM F2648) shall have smooth interior and annular exterior corrugations.

- 4-through 60 inch (100 to 1500 mm) shall meet ASTM F2648
- Manning's "n" value for use in design shall be 0.012

Joint Performance:

Pipe shall be joined using a bell & spigot joint meeting ASTM F2648. The joint shall be soil-tight and gaskets, when applicable, shall meet the requirements of ASTM F477. Gaskets shall be installed by the pipe manufacturer and covered with a removable wrap to ensure the gasket is free from debris. A joint lubricant supplied by the manufacturer shall be used on the gasket and bell during assembly.

EXHIBIT "A"
SPECIFICATIONS
HIDALGO COUNTY (All funding sources, programs & entities)
"PIPES & Related Miscellaneous Items"
RFB No.: 2017-046-04-05-FAZ

Fittings:

Fittings shall conform to ASTM F 2306. Bell and spigot connections shall utilize a spun-on or welded bell and valley or saddle gasket meeting the soil-tight joint performance requirements of ASTM F 2306.

Material Properties

Material for pipe production shall be an engineered compound of virgin and recycled high density polyethylene conforming with the minimum requirements of cell classification 424420C (ESCR Test Condition B) for 4-through 10 inch (100 to 250 mm) diameters, and 435420C (ESCR Test Condition B) for 12 through 60 inch (300 to 1500 mm) diameters, as defined and described in the latest version of ASTM D3350, except that carbon black content should not exceed 4%. The design engineer shall verify compatibility with overall system including structural, hydraulic, material and installation requirements for a given application.

Installation

Installation shall be in accordance with ASTM D2321 and manufacturers published installation guidelines, with the exception that minimum cover in trafficked areas for 4-through 48 inch (100 to 1200 mm) diameters shall be one foot. (0.3 m) and for 60 inch (1500 mm) diameters, the minimum cover shall be 2 ft. (0.6 m) in single run applications. Backfill for minimum fill heights depend on embedment material and compaction level; please refer to manufactures guide lines.

Pipe I.D.	4	6	8	10	12	15	18	24	30	36	42	48	60
In mm	(100)	(150)	(200)	(250)	(300)	(375)	(450)	(600)	(750)	(900)	(1050)	(1200)	(1500)
Pipe O.D. *	4.8	6.9	9.1	11.4	14.5	18	22	28	36	42	48	54	67
In mm	(122)	(175)	(231)	(290)	(368)	(457)	(559)	(711)	(914)	(1067)	(1219)	(1372)	(1702)
Perforations	All diameters availability with or without perforation												

*Pipe O.D. values ar provided for reference purposes only. Values stated for 12 through 60 inch are +/- 1 inch.

TERMS & CONDITIONS:

1. The contract term will be for a period of one (1) year period with Hidalgo County's option to extend the contract for an additional one (1) year under the same rates, terms and conditions.
2. Hidalgo County reserves the right to continue this bid for an additional sixty (60) day grace period at the end of the contract term for unforeseen delay in award of new bid for next contract.
3. Hidalgo County reserves the right to hold the bids received for a period of ninety (90) days without taking action hereon.
4. Hidalgo County may award the bid on a lump sum basis to one (1) bidder or to multiple bidders on an item by item basis in each category, whichever is in the best interest of the County. For evaluation and consideration of items bid, samples will be submitted upon request. Categories will be as follows.
5. Hidalgo County reserves the right to reject any/all bids, to waive any/all formalities or Technicalities, or to accept the bid considered the best and most advantageous to the County.
6. After bid is awarded and low bidder(s) default(s) in meeting the general instructions to bidders and/or comply with contractual agreement, Hidalgo County reserves the right to seek services from the next low bidder(s). In such event, County shall charge the successful bidder(s) the difference for any additional cost of such item(s).
7. Any contract awarded to a successful bidder will be in effect until:
 - (a) The contract expires,
 - (b) Delivery and acceptance of products and/or performance of service ordered,
 - (c) Terminated by County with thirty (30) days written notice prior to cancellation.
8. It is understood and agreed that in case Hidalgo County should need "any items listed" and it is not available within the time frame needed from the successful Bidder during the term of this contract, Hidalgo County reserves the right to purchase these items from other sources other than the successful Bidder and shall not be in violation of any terms or conditions of said contract.

EXHIBIT "A"
SPECIFICATIONS
HIDALGO COUNTY (All funding sources, programs & entities)
"PIPES & Related Miscellaneous Items"
RFB No.: 2017-046-04-05-FAZ

9. After Bid is awarded and successful awarded contractor(s) default(s) in meeting the general instructions to bidder(s) and/or compiling with Bid agreement, Hidalgo County reserves the right to seek services from the next low bidder. In such event, County shall charge the successful bidder the difference for any additional cost to such item.
10. Hidalgo County reserves the right to seek purchases from State awarded vendors or any other Cooperative Purchasing programs, whenever it is in the best interest of the County to do so.
11. Insurance requirements for this project to be maintained throughout the contract term (Refer to limits on the Exhibit "C" for limits); insurance certificate must be submitted to the Purchasing Department prior to any services being performed by the awarded bidder.
12. The bidder(s) awarded the contract **cannot** engage the services of a **subcontractor without prior written consent of Hidalgo County** to perform services hereunder. The successful bidder(s) must present evidence that the proposed subcontractor possess all the necessary licenses and permits to perform the services and that subcontractor has obtained the required insurance.
13. Bidder(s) agree that to the extent an item(s) is unavailable for Bidder's own inventory, Bidder(s) will be responsible for locating an alternative supplier and for providing the product or service to Hidalgo County.
14. Unit prices quoted shall remain firm for the period of the contract and shall include the cost of shipping and delivery of all items to the designated FOB point and must include any and all cost in the delivered unit price.

All costs and expenses associated with the preparation and submission of proposals shall be the responsibility of the submitter and no reimbursements for such charges or expenses shall be passed onto the County.

Market Volatility and Unit Price Adjustments:

Hidalgo County recognizes that during periods of national crisis and unstable economic conditions, unforeseen price increases might affect costs for goods and services contracted on an annual basis. The following procedure may be employed to mediate price volatility:

- **Requesting Price Adjustment:** Upon written request of the Vendor to the County Purchasing Agent, the County may review evidence of prevailing industry-wide market conditions that warrant an adjustment in bid prices contained in the contract.
- A Vendor must tie any price change clause to an industry-wide or otherwise nationally recognized index, or some other form of verifiable document. Such written request must be accompanied by a certified copy of the supplier's advisory or notification to the vendor of the price changes.
- The Vendor must put the Purchasing Agent on the mailing lists for such publications so that the Purchasing Agent can monitor said changes. Such membership shall be at no cost to the County.
- The County Purchasing Agent retains the right to determine whether or not such proposed price changes are in the best interest of the County.
- No price escalation will be authorized in excess of the amount of the increase referred to in the supplier's notice.
- The County may only grant a price increase if the evidence presented is deemed reliable. Should the County allow a price increase, the approved price change shall be honored for all orders received by the vendor or contractor after the effective date of such price change. Approved price changes are not applicable to orders already issued and in process at time of price change.
- **Price Reduction:** Vendor shall notify the County at the time when the Vendor's costs for items and/or supplies reduce due to stabilization in the market at which time prices for items on this contract shall be reduced accordingly. Failure by the Vendor to notify the County of a decrease in costs for items and/or supplies for which the Vendor was granted a price adjustment, may result in immediate termination of this contract and the County shall not be obligated to pay the Vendor the difference between the contract price and the price adjustment.

EXHIBIT "A"
SPECIFICATIONS
HIDALGO COUNTY (All funding sources, programs & entities)
"PIPES & Related Miscellaneous Items"
RFB No.: 2017-046-04-05-FAZ

Time Frame for Adjusted Price Increases: Price increases are only valid for the quarter in which they are requested and approved. Prices shall return to the original contract price at the beginning of the following quarter unless a Vendor notifies the County in writing within ten (10) days of expiration of the quarter in which the price increase is in effect, that it desires to have the price increase continue or that the Vendor is requesting a different price increase for the following quarter. Such request must be supplemented with sufficient justification to demonstrate that the price increase remains necessary. The County Purchasing Department shall have sole discretion whether to grant the price increase extension. The County too, shall have discretion to unilaterally reduce, eliminate or extend a price adjustment to the Vendor at any time upon written notice from the County to the Vendor demonstrating justification for such reduction, elimination or extension of the price adjustment.

Allowable Review Periods: Price adjustment reviews may only be requested by the Vendor on a quarterly basis. However, the County may at its own discretion, conduct temporary price adjustment reviews at any time. The County Purchasing Agent and/or the County Auditor reserve the right to audit and/or examine any pertinent books, documents, papers, records or invoices relating directly to the contract transaction in question after reasonable notice and during normal business hours.

Dollar Limit to Price Changes: The total increase in contract price shall not exceed twenty-five percent (25%) of the original contract price during the contract term.

ADDITIONAL INFORMATION

Hidalgo County is requesting that any and all questions, inquiries, and clarifications regarding quotes, bids, proposals, or statements of qualifications be addressed to, Martha L. Salazar, CPPB, Purchasing Agent, 2812 S. Business Hwy. 281, Edinburg, Texas 78539. **TELEPHONE INQUIRIES WILL NOT BE ACCEPTED.**

All written inquiries will be accepted via facsimile (956) 292-7612 or via e-mail to matilde.faz@co.hidalgo.tx.us by no later than, Monday, March 27, 2017 by 5:00 p.m. Responses to said inquiries will be sent to all applicants via-email by no later than Wednesday, March 29, 2017 by 5:00 p.m.

EXHIBIT “B”

BID PAGE

REQUEST FOR BIDS

Hidalgo County

(All funding sources, programs & entities)

“Pipes & Related Miscellaneous Items”

RFB No.: 2017-046-04-05-FAZ

EXHIBIT "B" – BID PAGE
Hidalgo County (All funding sources, programs & entities)
"PIPES & Related Miscellaneous Items"
RFB No.: 2017-046-04-05-FAZ

CATEGORY (A) – PIPES

CORRUGATED POLYVINYL CHLORIDE (PVC) STORM SEWER PIPE		
NIGP CODE: 665-89 Polyvinyl Chloride (PVC)		
DESCRIPTION	PRICE	
12"		LF
15"		LF
18"		LF
24"		LF
30"		LF
36"		LF
42"		LF
48"		LF

CORRUGATED STEEL STORM SEWER PIPE			
NIGP CODE: 210-29 Corrugated Galvanized Metal Pipe			
(UNIT PRICE INCLUDES ONE GASKETED BAND CONNECTION FOR EVERY 20 FOOT JOINT)			
DIAMETER	TYPE "IR" PIPE PRICE	TYPE "I" PIPE PRICE	TYPE "IA" PIPE PRICE
12"			LF
15"			LF
18"			LF
24"			LF
30"			LF
36"			LF
42"			LF
48"			LF
54"			LF
60"			LF
66"			LF
72"			LF
78"			LF
84"			LF
90"			LF
96"			LF
102"			LF
108"			LF
114"			LF
120"			LF
126"			LF
132"			LF
138"			LF
144"			LF

(EXHIBIT "B" – BID PAGE (

Hidalgo County (All funding sources, programs & entities)

"PIPES & Related Miscellaneous Items"

RFB No.: 2017-046-04-05-FAZ

REINFORCED CONCRETE PIPE – RUBBER GASKET JOINT PIPE						
NIGP CODE: 658-68						
DESCRIPTION	CLASS III PRICE		CLASS IV PRICE		CLASS V PRICE	
12"		LF		LF		LF
15"		LF		LF		LF
18"		LF		LF		LF
24"		LF		LF		LF
30"		LF		LF		LF
36"		LF		LF		LF
42"		LF		LF		LF
48"		LF		LF		LF
54"		LF		LF		LF
60"		LF		LF		LF
72"		LF		LF		LF

REINFORCED CONCRETE PIPE – TONGUE & GROOVE PIPE						
NIGP CODE: 658-68						
DESCRIPTION	CLASS III PRICE		CLASS IV PRICE		CLASS V PRICE	
12"		LF		LF		LF
15"		LF		LF		LF
18"		LF		LF		LF
24"		LF		LF		LF
30"		LF		LF		LF
36"		LF		LF		LF
42"		LF		LF		LF
48"		LF		LF		LF
54"		LF		LF		LF
60"		LF		LF		LF
72"		LF		LF		LF

REINFORCED POLYTHYLENE PIPE – 20 FOOT JOINTS		
NIGP CODE: 658-58		
DESCRIPTION	PRICE	
24"		LF
30"		LF
36"		LF
42"		LF
48"		LF
54"		LF
60"		LF
72"		LF
84"		LF
96"		LF

EXHIBIT "B" – BID PAGE
Hidalgo County (All funding sources, programs & entities)
"PIPES & Related Miscellaneous Items"
RFB No.: 2017-046-04-05-FAZ

AWWA C900 PVC PLASTIC PRESSURE PIPE					
NIGP CODE: 658-56 PLASTIC PIPES OR					
NIGP CODE: 658-60 PVC PIPES					
DESCRIPTION	DR 14 PRICE		DR 18 PRICE		DR 25 PRICE
4"		LF		LF	LF
6"		LF		LF	LF
8"		LF		LF	LF
10"		LF		LF	LF
12"		LF		LF	LF

AWWA C905 PVC PLASTIC WATER PIPE					
NIGP CODE: 658-56 PLASTIC PIPES OR					
NIGP CODE: 658-60 PVC PIPES					
DESCRIPTION	DR 18 PRICE	DR 25 PRICE	DR 32.5 PRICE	DR 41 PRICE	DR 51 PRICE
14"	LF	LF	LF	LF	LF
16"	LF	LF	LF	LF	LF
18"	LF	LF	LF	LF	LF
24"	LF	LF	LF	LF	LF
30"	LF	LF	LF	LF	LF
36"	LF	LF	LF	LF	LF
42"	LF	LF	LF	LF	LF
48"	LF	LF	LF	LF	LF

SDR 26 AND SDR 35 GASKETED GRAVITY SANITARY SEWER PIPE			
NIGP CODE: 210-35			
SEWER PIPE JOINT SEALING COMPOUND			
SIZE OF PIPE	SDR 26		SDR 35
4"		LF	LF
6"		LF	LF
8"		LF	LF
10"		LF	LF
12"		LF	LF
15"		LF	LF

HIGH PERFORMANCE (HP) POLYPROPYLENE STORM PIPE		
DESCRIPTION	PRICE	
12"		LF
15"		LF
18"		LF
24"		LF
30"		LF
36"		LF
42"		LF
48"		LF
60"		LF

EXHIBIT "B" – BID PAGE
Hidalgo County (All funding sources, programs & entities)
"PIPES & Related Miscellaneous Items"
RFB No.: 2017-046-04-05-FAZ

HIGH DESTINY POLYETHYLENE PIPE (HDPE)		
NIGP CODE: 658-58 Polyethylene Pipe And Fitting		
DESCRIPTION	PRICE	
4"		LF
6"		LF
8"		LF
10"		LF
12"		LF
15"		LF
18"		LF
24"		LF
30"		LF
36"		LF
42"		LF
48"		LF
54"		LF
60"		LF

PLUMBING PIPES – 20 FOOT SECTIONS		
NIGP CODE: 967-60		
PVC	PRICE	
½"		
1 ½"		
2"		
3"		
4"		

PLUMBING PIPES – 20 FOOT SECTIONS		
NIGP CODE: 967-60		
COPPER	PRICE	
½"		
¾"		

EXHIBIT "B" – BID PAGE
Hidalgo County (All funding sources, programs & entities)
"PIPES & Related Miscellaneous Items"
RFB No.: 2017-046-04-05-FAZ

CATEGORY (B) – INLETS
 NIGP CODE: 210-31

INLETS, AREA, SEWER DRAIN, PRECAST, CONCRETE, STORM DRAIN, NO BOTTOM FLOORS

DESCRIPTION	PRICE																
	2'	2 ½'	3'	3 ½'	4'	4 ½'	5'	5 ½'	6'	6 ½'	7'	7 ½'	8'	8 ½'	9'	9 ½'	10'
Type "A" Inlet (5' x 3')																	
Type "A-1" Inlet (5' x 4')																	
Type "A-2" Inlet (5' x 5')																	
Type "A-3" Inlet (5' x 6')																	
Type "A" (SPL-1) Inlet (5' x 3')																	
Type "A-1" (SPL-1) Inlet (5' x 4')																	
Type "A-2" (SPL-1) Inlet (5' x 5')																	
Type "A-3" (SPL-1) Inlet (5' x 6')																	
TYPE "C" INLET 2' X 2'																	
TYPE "C" INLET 3' X 3'																	
TYPE "C" INLET 4' X 4'																	
TYPE "CC" INLET 5' x 3'																	

EXHIBIT "B" – BID PAGE
Hidalgo County (All funding sources, programs & entities)
"PIPES & Related Miscellaneous Items"
RFB No.: 2017-046-04-05-FAZ

CATEGORY (D) – MISCELLANEOUS

DESCRIPTION		
WATER VALVE	UNIT	PRICE
2"	EA	
4"	EA	
6"	EA	
8"	EA	
10"	EA	
90 DEGREE ELBOW		
2"	EA	
4"	EA	
6"	EA	
8"	EA	
10"	EA	
45 DEGREE ELBOW		
2"	EA	
4"	EA	
6"	EA	
8"	EA	
10"	EA	
STEEL PIPE CASING WITH SPACERS		
4"	LF	
6"	LF	
12"	LF	
16"	LF	
24"	LF	
FIRE HYDRANT W/VALVE		
PVC SCHEDULE 40 WATER LINE DR 18		
2"	LF	
8"	LF	
PVC SCHEDULE 40		
1.5"	LF	
0.75"	LF	
0.5"	LF	
WATER SADDLE W/2' CORPORATE VALVE		
8" x 2"	EA	

EXHIBIT "B" – BID PAGE
Hidalgo County (All funding sources, programs & entities)
"PIPES & Related Miscellaneous Items"
RFB No.: 2017-046-04-05-FAZ

HP Dual Wall Marmac Couplers		
PIPE SIZE	PRICE	UNIT
12"		EA
15"		EA
18"		EA
24"		EA
30"		EA
36"		EA
42"		EA
48"		EA
60"		EA

HP Dual Wall Fabricated Tees		
PIPE SIZE	PRICE	UNIT
12"		EA
15"		EA
18"		EA
24"		EA
30"		EA
36"		EA
42"		EA
48"		EA
60"		EA

HP Dual Wall Fabricated Bends						
PIPE SIZE	11.25 Bend	22.5 Bend	30* Bend	45* Bend	90* Bend	Unit
12"						EA
15"						EA
18"						EA
24"						EA
30"						EA
36"						EA
42"						EA
48"						EA
60"						EA

EXHIBIT "B" – BID PAGE
Hidalgo County (All funding sources, programs & entities)
"PIPES & Related Miscellaneous Items"
RFB No.: 2017-046-04-05-FAZ

BIDDER/COMPANY NAME: _____

ADDRESS: _____

CITY: _____ **STATE:** _____ **ZIPCODE:** _____

PHONE No: _____ **FAX No:** _____ **CELL No** _____

AUTHORIZED SIGNATURE: _____

PRINTED NAME: _____

TITLE: _____ **DATE:** _____

EMAIL: _____

EXHIBIT “C”
INSURANCE REQUIREMENTS

REQUEST FOR BIDS

Hidalgo County

(All funding sources, programs & entities)

“Pipes & Related Miscellaneous Items”

RFB No.: 2017-046-04-05-FAZ

EXHIBIT “C”
Insurance Requirements
Applicable to the Acquisition of Goods and /or Services
(other than Professional Services)

The Bidder awarded the contract shall furnish proof of insurance, which will also include any subcontractor that is subcontracted by the bidder in at least the following limits, to be in place prior to providing any services under this Contract and to continue at all times in force in effect during the term of this Contract:

1. A Five Hundred Thousand Dollar (\$500,000.00) Comprehensive General Liability insurance policy providing additional coverage to all underlying liabilities of County.
2. Automobile liability insurance policy with limits of at least Three Hundred Thousand Dollars (\$300,000.00) per person and Five Hundred Thousand Dollars (\$500,000.00) per occurrence. Coverage should include injury to or death of persons and property damage claims with limits up to Five Hundred Thousand (\$500,000.00) arising out of the services provided to County hereunder.
3. Uninsured/Underinsured motorist coverage in an amount equal to the bodily injury limits set forth immediately above;
4. Workers compensation insurance in amounts established by Texas law, unless the Bidder is specifically exempted from the Texas Workers Compensation Act, Texas Labor Code Chapter 401, et. seq.

Hidalgo County will only accept certificates of insurance on an Acord form (as attached hereto). Certificates of insurance naming County as an **additional insured** shall be submitted to County for approval prior to any services being performed by Contractor. Each policy of insurance required hereunder shall extend for a period equivalent to, or longer than the term of the Contract, and any insurer hereunder shall be required to give at least thirty (30) days written notice to the County prior to the cancellation of any such coverage on the termination date, or otherwise. This Contract shall be automatically suspended upon the cancellation, or other termination, of any required policy of insurance hereunder, and such suspension shall continue until evidence adequate replacement coverage is provided to County. If replacement coverage is not provided within thirty (30) days following suspension of the Contract, this Contract shall automatically terminate.

ACORD		CERTIFICATE OF INSURANCE		DATE (MM/DD/YY)
PRODUCER		THIS CERTIFICATE IS ISSUED AS A MATTER OF INFORMATION ONLY AND CONFERS NO RIGHTS UPON THE CERTIFICATE HOLDER. THIS CERTIFICATE DOES NOT AMEND, EXTEND OR ALTER THE COVERAGE AFFORDED BY THE POLICIES BELOW.		
		INSURERS AFFORDING COVERAGE		
INSURED		INSURER A:		
		INSURER B:		
		INSURER C:		
		INSURER D:		
		INSURER E:		

COVERAGES

THE POLICIES OF INSURANCE LISTED BELOW HAVE BEEN ISSUED TO THE INSURED NAMED ABOVE FOR THE POLICY PERIOD INDICATED. NOTWITHSTANDING ANY REQUIREMENT, TERM OR CONDITION OF ANY CONTRACT OR OTHER DOCUMENT WITH RESPECT TO WHICH THIS CERTIFICATE MAY BE ISSUED OR MAY PERTAIN, THE INSURANCE AFFORDED BY THE POLICIES DESCRIBED HEREIN IS SUBJECT TO ALL THEIR TERMS, EXCLUSIONS AND CONDITIONS OF SUCH POLICIES. AGGREGATE LIMITS SHOWN MAY HAVE BEEN REDUCED BY PAID CLAIMS.

INSR LTR	TYPE OF INSURANCE	POLICY NUMBER	POLICY EFFECTIVE DATE (MM/DD/YY)	POLICY EXPIRATION DATE (MM/DD/YY)	LIMITS
A	GENERAL LIABILITY				EACH OCCURRENCE \$
	<input type="checkbox"/> COMMERCIAL GENERAL LIABILITY				PROPERTY DAMAGE (Any one fire) \$
	<input type="checkbox"/> CLAIMS MADE OCCUR				MEDICAL (Any one person) \$
	<input type="checkbox"/> OWNER'S & CONT. PROT				PERSONAL & ADV INJURY \$
	<input type="checkbox"/> OWNER'S PROTECTIVE LIABILITY				ANNUAL AGGREGATE \$
	<input type="checkbox"/> GEN'L AGGREGATE LIMIT APPLIES PER: POLICY PROJECT <input type="checkbox"/> LOC				PRODUCTS - CON/P/OP \$
					AGG \$
B	AUTOMOBILE LIABILITY				COMBINED SINGLE LIMIT (Ea accident) \$
	<input type="checkbox"/> ANY AUTO				BODILY INJURY (Per person) \$
	<input type="checkbox"/> ALL OWNED AUTOS				BODILY INJURY (Per accident) \$
	<input type="checkbox"/> SCHEDULED AUTOS				PROPERTY DAMAGE (Per accident) \$
	<input type="checkbox"/> HIRED AUTOS				
<input type="checkbox"/> NON-OWNED AUTOS					
	GARAGE LIABILITY				AUTO ONLY-EA ACCIDENT \$
	<input type="checkbox"/> ANY AUTO				OTHER THAN EA ACC \$
					AUTO ONLY AGG \$
C	EXCESS LIABILITY				EACH OCCURRENCE \$
	<input type="checkbox"/> OCCUR <input type="checkbox"/> CLAIMS MADE				AGGREGATE \$
	<input type="checkbox"/> DEDUCTIBLE				\$
	<input type="checkbox"/> RETENTION \$				\$
D	WORKERS COMPENSATION AND EMPLOYER'S LIABILITY				WC STATU- <input type="checkbox"/> OTHER TORY LIMITS
					E.L. EACH ACCIDENT \$
					E.L. DISEASE-EA EMPLOYEE \$
					E.L. DISEASE-POLICY LIMIT \$
	OTHER				

DESCRIPTION OF OPERATIONS / LOCATION / VEHICLES / EXCLUSIONS ADDED BY ENDORSEMENT / SPECIAL PROVISIONS
 County of Hidalgo shall be named as additional insured on all Commercial General Liability policies.

CERTIFICATE HOLDER	ADDITIONAL INSURED; INSURER LETTER:	CANCELLATION
Hidalgo County Attn: Purchasing Department 2812 S Highway Bus. 281 Edinburg, Texas 78539		SHOULD ANY OF THE ABOVE DESCRIBED POLICIES BY CANCELLED BEFORE THE EXPIRATION DATE THEREOF, THE ISSUING INSURER WILL ENDEAVOR TO MAIL 30 DAYS WRITTEN NOTICE TO THE CERTIFICATE HOLDER NAMED TO THE LEFT, BUT FAILURE TO DO SO SHALL IMPOSE NO OBLIGATION OR LIABILITY OF ANY KIND UPON THE INSURER, ITS AGENT'S OR REPRESENTATIVES.
		AUTHORIZED REPRESENTATIVE

Insurance Requirement Acknowledgment

I, _____, authorized representative for _____,
Company/Vendor

hereby acknowledge receipt of the County's required insurance limits. Said requirements:

- will be acquired within 10 working days after notification from Purchasing Department of bid awarded by the Hidalgo County Commissioners' Court;
- will acquire additional amounts required to meet the County's requirements within 10 working days after notification from Purchasing Department of bid award by the Hidalgo County Commissioners' Court; currently carry the following:

Automobile Liability: \$_____ General Liability: \$_____

- have already been met, see attached copy of insurance certificate.

Authorized Representative

Date

Notice to Bidder:

A certificate of insurance for the required insurance limits shall be provided to the Purchasing Department's Contract Managers in order to qualify for award of bid and to execute a contract between your Company and the County

Failure to provide Certificates of Insurance to the Purchasing Department's Contract Managers will cause the bid award to be rescinded and re-awarded to next lowest bidder. Certificates of Insurance will be monitored and verified on a **quarterly basis** to ensure coverage policy is in place. It is the Company's obligation to maintain the appropriate insurance coverage throughout the term of the contract.

THIS FORM MUST ACCOMPANY BID PACKET

**PROJECT REQUIREMENTS
ACKNOWLEDGMENT**

This is to certify that I, _____, possess all of the APPLICABLE:

- 1. Licenses: _____.
- 2. Bond (if applicable) _____.
- 3. Certificates: _____.
- 4. Permits: _____.
- 5. Other: _____.

necessary to carry out the required project. Furthermore, I am providing copies of the required documentation so that, if my company is awarded this bid, I may be eligible to enter into a contract with Hidalgo County and proceed to complete the project in a timely manner.

* Any licenses, bonds (if applicable), certificates, permits, etc. which are required must be presented as part of the bid packet in order to expedite the bid evaluation process.

Authorized Signature

Date

Company

Address

City, State, Zip

THIS FORM MUST ACCOMPANY BID PACKET

EXHIBIT “D”

CIQ FORM
CONFLICT OF INTEREST QUESTIONNAIRE

REQUEST FOR BIDS

Hidalgo County

(All funding sources, programs & entities)

“Pipes & Related Miscellaneous Items”

RFB No.: 2017-046-04-05-FAZ

CONFLICT OF INTEREST QUESTIONNAIRE

FORM CIQ

For vendor doing business with local governmental entity

This questionnaire reflects changes made to the law by H.B. 23, 84th Leg., Regular Session.

This questionnaire is being filed in accordance with Chapter 176, Local Government Code, by a vendor who has a business relationship as defined by Section 176.001(1-a) with a local governmental entity and the vendor meets requirements under Section 176.006(a).

By law this questionnaire must be filed with the records administrator of the local governmental entity not later than the 7th business day after the date the vendor becomes aware of facts that require the statement to be filed. See Section 176.006(a-1), Local Government Code.

A vendor commits an offense if the vendor knowingly violates Section 176.006, Local Government Code. An offense under this section is a misdemeanor.

OFFICE USE ONLY

Date Received

1 Name of vendor who has a business relationship with local governmental entity.

2 Check this box if you are filing an update to a previously filed questionnaire. (The law requires that you file an updated completed questionnaire with the appropriate filing authority not later than the 7th business day after the date on which you became aware that the originally filed questionnaire was incomplete or inaccurate.)

3 Name of local government officer about whom the information is being disclosed.

Name of Officer

4 Describe each employment or other business relationship with the local government officer, or a family member of the officer, as described by Section 176.003(a)(2)(A). Also describe any family relationship with the local government officer. Complete subparts A and B for each employment or business relationship described. Attach additional pages to this Form CIQ as necessary.

A. Is the local government officer or a family member of the officer receiving or likely to receive taxable income, other than investment income, from the vendor?

Yes No

B. Is the vendor receiving or likely to receive taxable income, other than investment income, from or at the direction of the local government officer or a family member of the officer AND the taxable income is not received from the local governmental entity?

Yes No

5 Describe each employment or business relationship that the vendor named in Section 1 maintains with a corporation or other business entity with respect to which the local government officer serves as an officer or director, or holds an ownership interest of one percent or more.

6 Check this box if the vendor has given the local government officer or a family member of the officer one or more gifts as described in Section 176.003(a)(2)(B), excluding gifts described in Section 176.003(a-1).

7

Signature of vendor doing business with the governmental entity

Date

CONFLICT OF INTEREST QUESTIONNAIRE
For vendor doing business with local governmental entity

A complete copy of Chapter 176 of the Local Government Code may be found at <http://www.statutes.legis.state.tx.us/Docs/LG/htm/LG.176.htm>. For easy reference, below are some of the sections cited on this form.

Local Government Code § 176.001(1-a): "Business relationship" means a connection between two or more parties based on commercial activity of one of the parties. The term does not include a connection based on:

- (A) a transaction that is subject to rate or fee regulation by a federal, state, or local governmental entity or an agency of a federal, state, or local governmental entity;
- (B) a transaction conducted at a price and subject to terms available to the public; or
- (C) a purchase or lease of goods or services from a person that is chartered by a state or federal agency and that is subject to regular examination by, and reporting to, that agency.

Local Government Code § 176.003(a)(2)(A) and (B):

(a) A local government officer shall file a conflicts disclosure statement with respect to a vendor if:

(2) the vendor:

(A) has an employment or other business relationship with the local government officer or a family member of the officer that results in the officer or family member receiving taxable income, other than investment income, that exceeds \$2,500 during the 12-month period preceding the date that the officer becomes aware that

(i) a contract between the local governmental entity and vendor has been executed;

or

(ii) the local governmental entity is considering entering into a contract with the vendor;

(B) has given to the local government officer or a family member of the officer one or more gifts that have an aggregate value of more than \$100 in the 12-month period preceding the date the officer becomes aware that:

(i) a contract between the local governmental entity and vendor has been executed; or

(ii) the local governmental entity is considering entering into a contract with the vendor.

Local Government Code § 176.006(a) and (a-1)

(a) A vendor shall file a completed conflict of interest questionnaire if the vendor has a business relationship with a local governmental entity and:

(1) has an employment or other business relationship with a local government officer of that local governmental entity, or a family member of the officer, described by Section 176.003(a)(2)(A);

(2) has given a local government officer of that local governmental entity, or a family member of the officer, one or more gifts with the aggregate value specified by Section 176.003(a)(2)(B), excluding any gift described by Section 176.003(a-1); or

(3) has a family relationship with a local government officer of that local governmental entity.

(a-1) The completed conflict of interest questionnaire must be filed with the appropriate records administrator not later than the seventh business day after the later of:

(1) the date that the vendor:

(A) begins discussions or negotiations to enter into a contract with the local governmental entity; or

(B) submits to the local governmental entity an application, response to a request for proposals or bids, correspondence, or another writing related to a potential contract with the local governmental entity; or

(2) the date the vendor becomes aware:

(A) of an employment or other business relationship with a local government officer, or a family member of the officer, described by Subsection (a);

(B) that the vendor has given one or more gifts described by Subsection (a); or

(C) of a family relationship with a local government officer.

VENDOR'S
APPLICATION
&
W-9 FORM

REQUEST FOR BIDS

Hidalgo County

(All funding sources, programs & entities)

“Pipes & Related Miscellaneous Items”

RFB No.: 2017-046-04-05-FAZ

HISTORICALLY UNDERUTILIZED BUSINESS (HUB) DECLARATION

The primary objective of the Hidalgo County HUB Program is to ensure Historically Underutilized Businesses receive a fair and equal opportunity for participation in the County's procurement process. This fact holds true for Services (Professional & Non-Professional), Commodities, and Construction contracts and any subcontracts thereto. The program strongly encourages Prime Contractors to provide subcontracting opportunities to Certified Hub Contractors/Vendors. Our goal for HUB contractor/vendor participation, as well as HUB subcontractor participation is 30%. To be considered as a "Certified HUB Contractor/Vendor" the contractor/vendor must have been certified by, and hold a current and valid certification with any of the three agencies listed below.

Have you been Certified as a HUB or an MBE/WBE source?: Yes No

If yes, by whom?: Texas Building & Procurement Commission Other _____

Indicate Certification No(s): _____ or Are Certificate(s) Attached?: Yes No

LIST OF CERTIFIED HUB SUBCONTRACTORS

(Attach additional pages if necessary)

What percentage of the Bid, RFP, or RFQ is to be subcontracted with Certified HUB sources?: _____ %
(List HUB Subcontractor information below).

HUB Subcontractor Name: _____ HUB Status: _____
Certifying Agency (Check all applicable): Texas Building & Procurement Commission Other
Address: _____ City: _____ State: _____ Zip: _____
Contact Person: _____ Title: _____ Phone No.: () _____
Subcontract Amount: \$ _____ Description of Work to be Performed: _____

HUB Subcontractor Name: _____ HUB Status: _____
Certifying Agency (Check all applicable): Texas Building & Procurement Commission Other
Address: _____ City: _____ State: _____ Zip: _____
Contact Person: _____ Title: _____ Phone No.: () _____
Subcontract Amount: \$ _____ Description of Work to be Performed: _____

HUB Subcontractor Name: _____ HUB Status: _____
Certifying Agency (Check all applicable): Texas Building & Procurement Commission Other
Address: _____ City: _____ State: _____ Zip: _____
Contact Person: _____ Title: _____ Phone No.: () _____
Subcontract Amount: \$ _____ Description of Work to be Performed: _____

Request for Taxpayer Identification Number and Certification

Give Form to the
 requester. Do not
 send to the IRS.

Print or type
 See Specific Instructions on page 2.

1 Name (as shown on your income tax return). Name is required on this line; do not leave this line blank.	
2 Business name/disregarded entity name, if different from above	
3 Check appropriate box for federal tax classification; check only one of the following seven boxes: <input type="checkbox"/> Individual/sole proprietor or single-member LLC <input type="checkbox"/> Limited liability company. Enter the tax classification (C=C corporation, S=S corporation, P=partnership) ▶ _____ Note. For a single-member LLC that is disregarded, do not check LLC; check the appropriate box in the line above for the tax classification of the single-member owner. <input type="checkbox"/> Other (see instructions) ▶ _____ <input type="checkbox"/> C Corporation <input type="checkbox"/> S Corporation <input type="checkbox"/> Partnership <input type="checkbox"/> Trust/estate	4 Exemptions (codes apply only to certain entities, not individuals; see instructions on page 3): Exempt payee code (if any) _____ Exemption from FATCA reporting code (if any) _____ <i>(Applies to accounts maintained outside the U.S.)</i>
5 Address (number, street, and apt. or suite no.)	Requester's name and address (optional)
6 City, state, and ZIP code	
7 List account number(s) here (optional)	

Part I Taxpayer Identification Number (TIN)

Enter your TIN in the appropriate box. The TIN provided must match the name given on line 1 to avoid backup withholding. For individuals, this is generally your social security number (SSN). However, for a resident alien, sole proprietor, or disregarded entity, see the Part I instructions on page 3. For other entities, it is your employer identification number (EIN). If you do not have a number, see *How to get a TIN* on page 3.

Note. If the account is in more than one name, see the instructions for line 1 and the chart on page 4 for guidelines on whose number to enter.

Social security number									
or									
Employer identification number									

Part II Certification

Under penalties of perjury, I certify that:

1. The number shown on this form is my correct taxpayer identification number (or I am waiting for a number to be issued to me); and
2. I am not subject to backup withholding because: (a) I am exempt from backup withholding, or (b) I have not been notified by the Internal Revenue Service (IRS) that I am subject to backup withholding as a result of a failure to report all interest or dividends, or (c) the IRS has notified me that I am no longer subject to backup withholding; and
3. I am a U.S. citizen or other U.S. person (defined below); and
4. The FATCA code(s) entered on this form (if any) indicating that I am exempt from FATCA reporting is correct.

Certification instructions. You must cross out item 2 above if you have been notified by the IRS that you are currently subject to backup withholding because you have failed to report all interest and dividends on your tax return. For real estate transactions, item 2 does not apply. For mortgage interest paid, acquisition or abandonment of secured property, cancellation of debt, contributions to an individual retirement arrangement (IRA), and generally, payments other than interest and dividends, you are not required to sign the certification, but you must provide your correct TIN. See the instructions on page 3.

Sign Here	Signature of U.S. person ▶ _____	Date ▶ _____
------------------	----------------------------------	--------------

General Instructions

Section references are to the Internal Revenue Code unless otherwise noted.
 Future developments. Information about developments affecting Form W-9 (such as legislation enacted after we release it) is at www.irs.gov/fw9.

Purpose of Form

An individual or entity (Form W-9 requester) who is required to file an information return with the IRS must obtain your correct taxpayer identification number (TIN) which may be your social security number (SSN), individual taxpayer identification number (ITIN), adoption taxpayer identification number (ATIN), or employer identification number (EIN), to report on an information return the amount paid to you, or other amount reportable on an information return. Examples of information returns include, but are not limited to, the following:

- Form 1099-INT (interest earned or paid)
- Form 1099-DIV (dividends, including those from stocks or mutual funds)
- Form 1099-MISC (various types of income, prizes, awards, or gross proceeds)
- Form 1099-B (stock or mutual fund sales and certain other transactions by brokers)
- Form 1099-S (proceeds from real estate transactions)
- Form 1099-K (merchant card and third party network transactions)

- Form 1098 (home mortgage interest), 1098-E (student loan interest), 1098-T (tuition)
 - Form 1099-C (canceled debt)
 - Form 1099-A (acquisition or abandonment of secured property)
- Use Form W-9 only if you are a U.S. person (including a resident alien), to provide your correct TIN.
- If you do not return Form W-9 to the requester with a TIN, you might be subject to backup withholding. See What is backup withholding? on page 2.*
- By signing the filled-out form, you:
1. Certify that the TIN you are giving is correct (or you are waiting for a number to be issued),
 2. Certify that you are not subject to backup withholding, or
 3. Claim exemption from backup withholding if you are a U.S. exempt payee. If applicable, you are also certifying that as a U.S. person, your allocable share of any partnership income from a U.S. trade or business is not subject to the withholding tax on foreign partners' share of effectively connected income, and
 4. Certify that FATCA code(s) entered on this form (if any) indicating that you are exempt from the FATCA reporting, is correct. See *What is FATCA reporting?* on page 2 for further information.

Note. If you are a U.S. person and a requester gives you a form other than Form W-9 to request your TIN, you must use the requester's form if it is substantially similar to this Form W-9.

Definition of a U.S. person. For federal tax purposes, you are considered a U.S. person if you are:

- An individual who is a U.S. citizen or U.S. resident alien;
- A partnership, corporation, company, or association created or organized in the United States or under the laws of the United States;
- An estate (other than a foreign estate); or
- A domestic trust (as defined in Regulations section 301.7701-7).

Special rules for partnerships. Partnerships that conduct a trade or business in the United States are generally required to pay a withholding tax under section 1446 on any foreign partners' share of effectively connected taxable income from such business. Further, in certain cases where a Form W-9 has not been received, the rules under section 1446 require a partnership to presume that a partner is a foreign person, and pay the section 1446 withholding tax. Therefore, if you are a U.S. person that is a partner in a partnership conducting a trade or business in the United States, provide Form W-9 to the partnership to establish your U.S. status and avoid section 1446 withholding on your share of partnership income.

In the cases below, the following person must give Form W-9 to the partnership for purposes of establishing its U.S. status and avoiding withholding on its allocable share of net income from the partnership conducting a trade or business in the United States:

- In the case of a disregarded entity with a U.S. owner, the U.S. owner of the disregarded entity and not the entity;
- In the case of a grantor trust with a U.S. grantor or other U.S. owner, generally, the U.S. grantor or other U.S. owner of the grantor trust and not the trust; and
- In the case of a U.S. trust (other than a grantor trust), the U.S. trust (other than a grantor trust) and not the beneficiaries of the trust.

Foreign person. If you are a foreign person or the U.S. branch of a foreign bank that has elected to be treated as a U.S. person, do not use Form W-9. Instead, use the appropriate Form W-8 or Form 8233 (see Publication 515, Withholding of Tax on Nonresident Aliens and Foreign Entities).

Nonresident alien who becomes a resident alien. Generally, only a nonresident alien individual may use the terms of a tax treaty to reduce or eliminate U.S. tax on certain types of income. However, most tax treaties contain a provision known as a "saving clause." Exceptions specified in the saving clause may permit an exemption from tax to continue for certain types of income even after the payee has otherwise become a U.S. resident alien for tax purposes.

If you are a U.S. resident alien who is relying on an exception contained in the saving clause of a tax treaty to claim an exemption from U.S. tax on certain types of income, you must attach a statement to Form W-9 that specifies the following five items:

1. The treaty country. Generally, this must be the same treaty under which you claimed exemption from tax as a nonresident alien.
2. The treaty article addressing the income.
3. The article number (or location) in the tax treaty that contains the saving clause and its exceptions.
4. The type and amount of income that qualifies for the exemption from tax.
5. Sufficient facts to justify the exemption from tax under the terms of the treaty article.

Example. Article 20 of the U.S.-China income tax treaty allows an exemption from tax for scholarship income received by a Chinese student temporarily present in the United States. Under U.S. law, this student will become a resident alien for tax purposes if his or her stay in the United States exceeds 5 calendar years. However, paragraph 2 of the first Protocol to the U.S.-China treaty (dated April 30, 1984) allows the provisions of Article 20 to continue to apply even after the Chinese student becomes a resident alien of the United States. A Chinese student who qualifies for this exception (under paragraph 2 of the first protocol) and is relying on this exception to claim an exemption from tax on his or her scholarship or fellowship income would attach to Form W-9 a statement that includes the information described above to support that exemption.

If you are a nonresident alien or a foreign entity, give the requester the appropriate completed Form W-8 or Form 8233.

Backup Withholding

What is backup withholding? Persons making certain payments to you must under certain conditions withhold and pay to the IRS 28% of such payments. This is called "backup withholding." Payments that may be subject to backup withholding include interest, tax-exempt interest, dividends, broker and barter exchange transactions, rents, royalties, nonemployee pay, payments made in settlement of payment card and third party network transactions, and certain payments from fishing boat operators. Real estate transactions are not subject to backup withholding.

You will not be subject to backup withholding on payments you receive if you give the requester your correct TIN, make the proper certifications, and report all your taxable interest and dividends on your tax return.

Payments you receive will be subject to backup withholding if:

1. You do not furnish your TIN to the requester,
2. You do not certify your TIN when required (see the Part II instructions on page 3 for details),

3. The IRS tells the requester that you furnished an incorrect TIN,

4. The IRS tells you that you are subject to backup withholding because you did not report all your interest and dividends on your tax return (for reportable interest and dividends only), or

5. You do not certify to the requester that you are not subject to backup withholding under 4 above (for reportable interest and dividend accounts opened after 1983 only).

Certain payees and payments are exempt from backup withholding. See *Exempt payee code* on page 3 and the separate instructions for the Requester of Form W-9 for more information.

Also see *Special rules for partnerships* above.

What is FATCA reporting?

The Foreign Account Tax Compliance Act (FATCA) requires a participating foreign financial institution to report all United States account holders that are specified United States persons. Certain payees are exempt from FATCA reporting. See *Exemption from FATCA reporting code* on page 3 and the instructions for the Requester of Form W-9 for more information.

Updating Your Information

You must provide updated information to any person to whom you claimed to be an exempt payee if you are no longer an exempt payee and anticipate receiving reportable payments in the future from this person. For example, you may need to provide updated information if you are a C corporation that elects to be an S corporation, or if you no longer are tax exempt. In addition, you must furnish a new Form W-9 if the name or TIN changes for the account; for example, if the grantor of a grantor trust dies.

Penalties

Failure to furnish TIN. If you fail to furnish your correct TIN to a requester, you are subject to a penalty of \$50 for each such failure unless your failure is due to reasonable cause and not to willful neglect.

Civil penalty for false information with respect to withholding. If you make a false statement with no reasonable basis that results in no backup withholding, you are subject to a \$500 penalty.

Criminal penalty for falsifying information. Willfully falsifying certifications or affirmations may subject you to criminal penalties including fines and/or imprisonment.

Misuse of TINs. If the requester discloses or uses TINs in violation of federal law, the requester may be subject to civil and criminal penalties.

Specific Instructions

Line 1

You must enter one of the following on this line; do not leave this line blank. The name should match the name on your tax return.

If this Form W-9 is for a joint account, list first, and then circle, the name of the person or entity whose number you entered in Part I of Form W-9.

a. **Individual.** Generally, enter the name shown on your tax return. If you have changed your last name without informing the Social Security Administration (SSA) of the name change, enter your first name, the last name as shown on your social security card, and your new last name.

Note. ITIN applicant: Enter your individual name as it was entered on your Form W-7 application, line 1a. This should also be the same as the name you entered on the Form 1040/1040A/1040EZ you filed with your application.

b. **Sole proprietor or single-member LLC.** Enter your individual name as shown on your 1040/1040A/1040EZ on line 1. You may enter your business, trade, or "doing business as" (DBA) name on line 2.

c. **Partnership, LLC that is not a single-member LLC, C Corporation, or S Corporation.** Enter the entity's name as shown on the entity's tax return on line 1 and any business, trade, or DBA name on line 2.

d. **Other entities.** Enter your name as shown on required U.S. federal tax documents on line 1. This name should match the name shown on the charter or other legal document creating the entity. You may enter any business, trade, or DBA name on line 2.

e. **Disregarded entity.** For U.S. federal tax purposes, an entity that is disregarded as an entity separate from its owner is treated as a "disregarded entity." See Regulations section 301.7701-2(c)(2)(iii). Enter the owner's name on line 1. The name of the entity entered on line 1 should never be a disregarded entity. The name on line 1 should be the name shown on the income tax return on which the income should be reported. For example, if a foreign LLC that is treated as a disregarded entity for U.S. federal tax purposes has a single owner that is a U.S. person, the U.S. owner's name is required to be provided on line 1. If the direct owner of the entity is also a disregarded entity, enter the first owner that is not disregarded for federal tax purposes. Enter the disregarded entity's name on line 2, "Business name/disregarded entity name." If the owner of the disregarded entity is a foreign person, the owner must complete an appropriate Form W-8 instead of a Form W-9. This is the case even if the foreign person has a U.S. TIN.

Line 2

If you have a business name, trade name, DBA name, or disregarded entity name, you may enter it on line 2.

Line 3

Check the appropriate box in line 3 for the U.S. federal tax classification of the person whose name is entered on line 1. Check only one box in line 3.

Limited Liability Company (LLC). If the name on line 1 is an LLC treated as a partnership for U.S. federal tax purposes, check the "Limited Liability Company" box and enter "P" in the space provided. If the LLC has filed Form 8832 or 2553 to be taxed as a corporation, check the "Limited Liability Company" box and in the space provided enter "C" for C corporation or "S" for S corporation. If it is a single-member LLC that is a disregarded entity, do not check the "Limited Liability Company" box; instead check the first box in line 3 "Individual/sole proprietor or single-member LLC."

Line 4, Exemptions

If you are exempt from backup withholding and/or FATCA reporting, enter in the appropriate space in line 4 any code(s) that may apply to you.

Exempt payee code.

- Generally, individuals (including sole proprietors) are not exempt from backup withholding.
- Except as provided below, corporations are exempt from backup withholding for certain payments, including interest and dividends.
- Corporations are not exempt from backup withholding for payments made in settlement of payment card or third party network transactions.
- Corporations are not exempt from backup withholding with respect to attorneys' fees or gross proceeds paid to attorneys, and corporations that provide medical or health care services are not exempt with respect to payments reportable on Form 1099-MISC.

The following codes identify payees that are exempt from backup withholding. Enter the appropriate code in the space in line 4.

- 1—An organization exempt from tax under section 501(a), any IRA, or a custodial account under section 403(b)(7) if the account satisfies the requirements of section 401(f)(2)
- 2—The United States or any of its agencies or instrumentalities
- 3—A state, the District of Columbia, a U.S. commonwealth or possession, or any of their political subdivisions or instrumentalities
- 4—A foreign government or any of its political subdivisions, agencies, or instrumentalities
- 5—A corporation
- 6—A dealer in securities or commodities required to register in the United States, the District of Columbia, or a U.S. commonwealth or possession
- 7—A futures commission merchant registered with the Commodity Futures Trading Commission
- 8—A real estate investment trust
- 9—An entity registered at all times during the tax year under the Investment Company Act of 1940
- 10—A common trust fund operated by a bank under section 584(a)
- 11—A financial institution
- 12—A middleman known in the investment community as a nominee or custodian
- 13—A trust exempt from tax under section 664 or described in section 4947

The following chart shows types of payments that may be exempt from backup withholding. The chart applies to the exempt payees listed above, 1 through 13.

IF the payment is for . . .	THEN the payment is exempt for . . .
Interest and dividend payments	All exempt payees except for 7
Broker transactions	Exempt payees 1 through 4 and 6 through 11 and all C corporations. S corporations must not enter an exempt payee code because they are exempt only for sales of noncovered securities acquired prior to 2012.
Barter exchange transactions and patronage dividends	Exempt payees 1 through 4
Payments over \$600 required to be reported and direct sales over \$5,000 ¹	Generally, exempt payees 1 through 5 ²
Payments made in settlement of payment card or third party network transactions	Exempt payees 1 through 4

¹ See Form 1099-MISC, Miscellaneous Income, and its instructions.

² However, the following payments made to a corporation and reportable on Form 1099-MISC are not exempt from backup withholding: medical and health care payments, attorneys' fees, gross proceeds paid to an attorney reportable under section 6045(f), and payments for services paid by a federal executive agency.

Exemption from FATCA reporting code. The following codes identify payees that are exempt from reporting under FATCA. These codes apply to persons submitting this form for accounts maintained outside of the United States by certain foreign financial institutions. Therefore, if you are only submitting this form for an account you hold in the United States, you may leave this field blank. Consult with the person requesting this form if you are uncertain if the financial institution is subject to these requirements. A requester may indicate that a code is not required by providing you with a Form W-9 with "Not Applicable" (or any similar indication) written or printed on the line for a FATCA exemption code.

- A—An organization exempt from tax under section 501(a) or any individual retirement plan as defined in section 7701(a)(37)
- B—The United States or any of its agencies or instrumentalities
- C—A state, the District of Columbia, a U.S. commonwealth or possession, or any of their political subdivisions or instrumentalities
- D—A corporation the stock of which is regularly traded on one or more established securities markets, as described in Regulations section 1.1472-1(c)(1)(i)
- E—A corporation that is a member of the same expanded affiliated group as a corporation described in Regulations section 1.1472-1(c)(1)(i)
- F—A dealer in securities, commodities, or derivative financial instruments (including notional principal contracts, futures, forwards, and options) that is registered as such under the laws of the United States or any state
- G—A real estate investment trust
- H—A regulated investment company as defined in section 851 or an entity registered at all times during the tax year under the Investment Company Act of 1940
- I—A common trust fund as defined in section 584(a)
- J—A bank as defined in section 581
- K—A broker
- L—A trust exempt from tax under section 664 or described in section 4947(a)(1)
- M—A tax exempt trust under a section 403(b) plan or section 457(g) plan

Note. You may wish to consult with the financial institution requesting this form to determine whether the FATCA code and/or exempt payee code should be completed.

Line 5

Enter your address (number, street, and apartment or suite number). This is where the requester of this Form W-9 will mail your information returns.

Line 6

Enter your city, state, and ZIP code.

Part I. Taxpayer Identification Number (TIN)

Enter your TIN in the appropriate box. If you are a resident alien and you do not have and are not eligible to get an SSN, your TIN is your IRS individual taxpayer identification number (ITIN). Enter it in the social security number box. If you do not have an ITIN, see *How to get a TIN* below.

If you are a sole proprietor and you have an EIN, you may enter either your SSN or EIN. However, the IRS prefers that you use your SSN.

If you are a single-member LLC that is disregarded as an entity separate from its owner (see *Limited Liability Company (LLC)* on this page), enter the owner's SSN (or EIN, if the owner has one). Do not enter the disregarded entity's EIN. If the LLC is classified as a corporation or partnership, enter the entity's EIN.

Note. See the chart on page 4 for further clarification of name and TIN combinations.

How to get a TIN. If you do not have a TIN, apply for one immediately. To apply for an SSN, get Form SS-5, Application for a Social Security Card, from your local SSA office or get this form online at www.ssa.gov. You may also get this form by calling 1-800-772-1213. Use Form W-7, Application for IRS Individual Taxpayer Identification Number, to apply for an ITIN, or Form SS-4, Application for Employer Identification Number, to apply for an EIN. You can apply for an EIN online by accessing the IRS website at www.irs.gov/businesses and clicking on Employer Identification Number (EIN) under Starting a Business. You can get Forms W-7 and SS-4 from the IRS by visiting IRS.gov or by calling 1-800-TAX-FORM (1-800-829-3676).

If you are asked to complete Form W-9 but do not have a TIN, apply for a TIN and write "Applied For" in the space for the TIN, sign and date the form, and give it to the requester. For interest and dividend payments, and certain payments made with respect to readily tradable instruments, generally you will have 60 days to get a TIN and give it to the requester before you are subject to backup withholding on payments. The 60-day rule does not apply to other types of payments. You will be subject to backup withholding on all such payments until you provide your TIN to the requester.

Note. Entering "Applied For" means that you have already applied for a TIN or that you intend to apply for one soon.

Caution: A disregarded U.S. entity that has a foreign owner must use the appropriate Form W-8.

Part II. Certification

To establish to the withholding agent that you are a U.S. person, or resident alien, sign Form W-9. You may be requested to sign by the withholding agent even if items 1, 4, or 5 below indicate otherwise.

For a joint account, only the person whose TIN is shown in Part I should sign (when required). In the case of a disregarded entity, the person identified on line 1 must sign. Exempt payees, see *Exempt payee code* earlier.

Signature requirements. Complete the certification as indicated in items 1 through 5 below.

1. Interest, dividend, and barter exchange accounts opened before 1984 and broker accounts considered active during 1983. You must give your correct TIN, but you do not have to sign the certification.

2. Interest, dividend, broker, and barter exchange accounts opened after 1983 and broker accounts considered inactive during 1983. You must sign the certification or backup withholding will apply. If you are subject to backup withholding and you are merely providing your correct TIN to the requester, you must cross out item 2 in the certification before signing the form.

3. Real estate transactions. You must sign the certification. You may cross out item 2 of the certification.

4. Other payments. You must give your correct TIN, but you do not have to sign the certification unless you have been notified that you have previously given an incorrect TIN. "Other payments" include payments made in the course of the requester's trade or business for rents, royalties, goods (other than bills for merchandise), medical and health care services (including payments to corporations), payments to a nonemployee for services, payments made in settlement of payment card and third party network transactions, payments to certain fishing boat crew members and fishermen, and gross proceeds paid to attorneys (including payments to corporations).

5. Mortgage interest paid by you, acquisition or abandonment of secured property, cancellation of debt, qualified tuition program payments (under section 529), IRA, Coverdell ESA, Archer MSA or HSA contributions or distributions, and pension distributions. You must give your correct TIN, but you do not have to sign the certification.

What Name and Number To Give the Requester

For this type of account:	Give name and SSN of:
1. Individual	The individual
2. Two or more individuals (joint account)	The actual owner of the account or, if combined funds, the first individual on the account ¹
3. Custodian account of a minor (Uniform Gift to Minors Act)	The minor ²
4. a. The usual revocable savings trust (grantor is also trustee) b. So-called trust account that is not a legal or valid trust under state law	The grantor-trustee ¹ The actual owner ¹
5. Sole proprietorship or disregarded entity owned by an individual	The owner ²
6. Grantor trust filing under Optional Form 1099 Filing Method 1 (see Regulations section 1.671-4(b)(2)(i)(A))	The grantor ²
For this type of account:	Give name and EIN of:
7. Disregarded entity not owned by an individual	The owner
8. A valid trust, estate, or pension trust	Legal entity ⁴
9. Corporation or LLO electing corporate status on Form 8832 or Form 2553	The corporation
10. Association, club, religious, charitable, educational, or other tax-exempt organization	The organization
11. Partnership or multi-member LLC	The partnership
12. A broker or registered nominee	The broker or nominee
13. Account with the Department of Agriculture in the name of a public entity (such as a state or local government, school district, or prison) that receives agricultural program payments	The public entity
14. Grantor trust filing under the Form 1041 Filing Method or the Optional Form 1099 Filing Method 2 (see Regulations section 1.671-4(b)(2)(ii)(B))	The trust

¹ List first and circle the name of the person whose number you furnish. If only one person on a joint account has an SSN, that person's number must be furnished.

² Circle the minor's name and furnish the minor's SSN.

³ You must show your individual name and you may also enter your business or DBA name on the "Business name/disregarded entity" name line. You may use either your SSN or EIN (if you have one), but the IRS encourages you to use your SSN.

⁴ List first and circle the name of the trust, estate, or pension trust. (Do not furnish the TIN of the personal representative or trustee unless the legal entity itself is not designated in the account title.) Also see *Special rules for partnerships* on page 2.

*Note. Grantor also must provide a Form W-9 to trustee of trust.

Note. If no name is circled when more than one name is listed, the number will be considered to be that of the first name listed.

Secure Your Tax Records from Identity Theft

Identity theft occurs when someone uses your personal information such as your name, SSN, or other identifying information, without your permission, to commit fraud or other crimes. An identity thief may use your SSN to get a job or may file a tax return using your SSN to receive a refund.

To reduce your risk:

- Protect your SSN,
- Ensure your employer is protecting your SSN, and
- Be careful when choosing a tax preparer.

If your tax records are affected by identity theft and you receive a notice from the IRS, respond right away to the name and phone number printed on the IRS notice or letter.

If your tax records are not currently affected by identity theft but you think you are at risk due to a lost or stolen purse or wallet, questionable credit card activity or credit report, contact the IRS Identity Theft Hotline at 1-800-908-4490 or submit Form 14039.

For more information, see Publication 4535, Identity Theft Prevention and Victim Assistance.

Victims of identity theft who are experiencing economic harm or a system problem, or are seeking help in resolving tax problems that have not been resolved through normal channels, may be eligible for Taxpayer Advocate Service (TAS) assistance. You can reach TAS by calling the TAS toll-free case intake line at 1-877-777-4778 or TTY/TDD 1-800-829-4059.

Protect yourself from suspicious emails or phishing schemes. Phishing is the creation and use of email and websites designed to mimic legitimate business emails and websites. The most common act is sending an email to a user falsely claiming to be an established legitimate enterprise in an attempt to scam the user into surrendering private information that will be used for identity theft.

The IRS does not initiate contacts with taxpayers via emails. Also, the IRS does not request personal detailed information through email or ask taxpayers for the PIN numbers, passwords, or similar secret access information for their credit card, bank, or other financial accounts.

If you receive an unsolicited email claiming to be from the IRS, forward this message to phishing@irs.gov. You may also report misuse of the IRS name, logo, or other IRS property to the Treasury Inspector General for Tax Administration (TIGTA) at 1-800-366-4484. You can forward suspicious emails to the Federal Trade Commission at: spam@uce.gov or contact them at www.ftc.gov/idtheft or 1-877-IDTHEFT (1-877-438-4338).

Visit irs.gov to learn more about identity theft and how to reduce your risk.

Privacy Act Notice

Section 6109 of the Internal Revenue Code requires you to provide your correct TIN to persons (including federal agencies) who are required to file information returns with the IRS to report interest, dividends, or certain other income paid to you; mortgage interest you paid; the acquisition or abandonment of secured property; the cancellation of debt; or contributions you made to an IRA, Archer MSA, or HSA. The person collecting this form uses the information on the form to file information returns with the IRS, reporting the above information. Routine uses of this information include giving it to the Department of Justice for civil and criminal litigation and to cities, states, the District of Columbia, and U.S. commonwealths and possessions for use in administering their laws. The information also may be disclosed to other countries under a treaty, to federal and state agencies to enforce civil and criminal laws, or to federal law enforcement and intelligence agencies to combat terrorism. You must provide your TIN whether or not you are required to file a tax return. Under section 3406, payers must generally withhold a percentage of taxable interest, dividend, and certain other payments to a payee who does not give a TIN to the payer. Certain penalties may also apply for providing false or fraudulent information.

CERTIFICATION REGARDING
DEBARMENT

REQUEST FOR BIDS

Hidalgo County

(All funding sources, programs & entities)

“Pipes & Related Miscellaneous Items”

RFB No.: 2017-046-04-05-FAZ

**Certification
Regarding Debarment, Suspension and Ineligibility**

As is required by the Federal Regulations Implementing Executive Order 12549, Debarment and Suspension, 45 CFR Part 76, Government-wide Debarment and Suspension, the applicant certifies, to the best of his or her knowledge and belief, that both it and its principals:

- a. Are not presently debarred, suspended, proposed for debarment, declared ineligible, or voluntarily excluded from participation in this transaction by any federal department or agency;
- b. Have not within a three-year period preceding this bid proposal and/or application been convicted of or had a civil judgment rendered against them for commission of fraud or a criminal offense in connection with obtaining, attempting to obtain, or performing a public (federal, state, or local) transaction or contract under a public transaction, violation of federal or state antitrust statutes or commission of embezzlement, theft, forgery, bribery, falsification or destruction of records, making false statements, or receiving stolen property;
- c. Are not presently indicted for or otherwise criminally or civilly charged by a government entity with commission of any of the offenses enumerated herein; and
- d. Have not within a three-year period preceding this bid proposal and/or application had one or more public transactions terminated for cause or default.

Signature: _____
Print Name: _____
Title: _____
Telephone Number: _____
Date: _____

If the bidder is unable to certify to all of the statements in this Certification, such bidder should attach an explanation to this proposal.

EXHIBIT "G"
APPENDICES

APPENDIX A

During the performance of this contract, the contractor, for itself, its assignees, and successors in interest (hereinafter referred to as the "contractor") agrees as follows:

1. **Compliance with Regulations:** The contractor (hereinafter includes consultants) will comply with the Acts and the Regulations relative to Nondiscrimination in Federally-assisted programs of the U.S. Department of Transportation, the Federal Highway Administration, as they may be amended from time to time, which are herein incorporated by reference and made a part of this contract.
2. **Nondiscrimination:** The contractor, with regard to the work performed by it during the contract, will not discriminate on the grounds of race, color, or national origin in the selection and retention of subcontractors, including procurements of materials and leases of equipment. The contractor will not participate directly or indirectly in the discrimination prohibited by the Acts and the Regulations, including employment practices when the contract covers any activity, project, or program set forth in Appendix B of 49 CFR Part 21.
3. **Solicitations for Subcontracts, Including Procurements of Materials and Equipment:** In all solicitations, either by competitive bidding, or negotiation made by the contractor for work to be performed under a subcontract, including procurements of materials, or leases of equipment, each potential subcontractor or supplier will be notified by the contractor of the contractor's obligations under this contract and the Acts and the Regulations relative to Nondiscrimination on the grounds of race, color, or national origin.
4. **Information and Reports:** The contractor will provide all information and reports required by the Acts, the Regulations, and directives issued pursuant thereto and will permit access to its books, records, accounts, other sources of information, and its facilities as may be determined by the Recipient or the Federal Highway Administration to be pertinent to ascertain compliance with such Acts, Regulations, and instructions. Where any information required of a contractor is in the exclusive possession of another who fails or refuses to furnish the information, the contractor will so certify to the Recipient or the Federal Highway Administration, as appropriate, and will set forth what efforts it has made to obtain the information.
5. **Sanctions for Noncompliance:** In the event of a contractor's noncompliance with the Nondiscrimination provisions of this contract, the Recipient will impose such contract sanctions as it or the Federal Highway Administration may determine to be appropriate, including, but not limited to:
 - a. withholding payments to the contractor under the contract until the contractor complies; and/or
 - b. cancelling, terminating, or suspending contract, in whole or in part.
6. **Incorporation of Provisions:** The contractor will include the provisions of paragraphs one through six in every subcontract, including procurements of materials and leases of equipment, unless exempt by the Acts, the Regulations and directives issued pursuant thereto. The contractor will take action with respect to any subcontract or procurement as the Recipient or the Federal Highway Administration may direct as a means of enforcing such provisions including sanctions for noncompliance. Provided, that if the contractor becomes involved in, or is threatened with litigation by a subcontractor, or supplier because of such direction, the contractor may request the Recipient to enter into any litigation to protect the interests of the Recipient. In addition, the contractor may request the United States to enter into the litigation to protect the interests of the United States.

APPENDIX B

CLAUSES FOR DEEDS TRANSFERRING UNITED STATES PROPERTY

The following clauses will be included in deeds effecting or recording the transfer of real property, structures, or improvements thereon, or granting interest therein from the United States pursuant to the provisions of Assurance 4:

NOW, THEREFORE, the U.S. Department of Transportation as authorized by law and upon the condition that the **COUNTY OF HIDALGO** will accept title to the lands and maintain the project constructed thereon in accordance with all applicable federal statutes, the Regulations for the Administration of all Department of Transportation programs, and the policies and procedures prescribed by the Federal Highway Administration of the U.S. Department of Transportation in accordance and in compliance with all requirements imposed by Title 49, Code of Federal Regulations, U.S. Department of Transportation, Subtitle A, Office of the Secretary, Part 21, Nondiscrimination in Federally-assisted programs of the U.S. Department of Transportation pertaining to and effectuating the provisions of Title VI of the Civil Rights Act of 1964 (78 Stat. 252; 42 U.S.C. § 2000d to 2000d-4), does hereby remise, release, quitclaim and convey unto the **COUNTY OF HIDALGO** all the right, title and interest of the U.S. Department of Transportation in and to said lands described in Exhibit 1 attached hereto and made a part hereof.

(HABENDUM CLAUSE)

TO HAVE AND TO HOLD said lands and interests therein unto **COUNTY OF HIDALGO** and its successors forever, subject, however, to the covenants, conditions, restrictions and reservations herein contained as follows, which will remain in effect for the period during which the real property or structures are used for a purpose for which Federal financial assistance is extended or for another purpose involving the provision of similar services or benefits and will be binding on the **COUNTY OF HIDALGO**, its successors and assigns.

The **COUNTY OF HIDALGO**, in consideration of the conveyance of said lands and interests in lands, does hereby covenant and agree as a covenant running with the land for itself, its successors and assigns, that (1) no person will on the grounds of race, color, or national origin, be excluded from participation in, be denied the benefits of, or be otherwise subjected to discrimination with regard to any facility located wholly or in part on, over, or under such lands hereby conveyed [,] [and]* (2) that the **COUNTY OF HIDALGO** will use the lands and interests in lands and interests in lands so conveyed, in compliance with all requirements imposed by or pursuant to Title 49, Code of Federal Regulations, U.S. Department of Transportation, Subtitle A, Office of the Secretary, Part 21, Nondiscrimination in Federally-assisted programs of the U.S. Department of Transportation, Effectuation of Title VI of the Civil Rights Act of 1964, and as said Regulations and Acts may be amended[, and (3) that in the event of breach of any of the above-mentioned nondiscrimination conditions, the Department will have a right to enter or re-enter said lands and facilities on said land, and that above described land and facilities will thereon revert to and vest in and become the absolute property of the U.S. Department of Transportation and its assigns as such interest existed prior to this instruction].*

(*Reverted clause and related language to be used only when it is determined that such a clause is necessary in order to make clear the purpose of Title VI.)

APPENDIX C

CLAUSES FOR TRANSFER OF REAL PROPERTY ACQUIRED OR IMPROVED UNDER THE ACTIVITY, FACILITY, OR PROGRAM

The following clauses will be included in deeds, licenses, leases, permits, or similar instruments entered into by the **COUNTY OF HIDALGO** pursuant to the provisions of Assurance 7(a):

- A. The (grantee, lessee, permittee, etc. as appropriate) for himself/herself, his/her heirs, personal representatives, successors in interest, and assigns, as a part of the consideration hereof, does hereby covenant and agree [in the case of deeds and leases add "as a covenant running with the land"] that:
 1. In the event facilities are constructed, maintained, or otherwise operated on the property described in this (deed, license, lease, permit, etc.) for a purpose for which a U.S. Department of Transportation activity, facility, or program is extended or for another purpose involving the provision of similar services or benefits, the (grantee, licensee, lessee, permitted, etc.) will maintain and operate such facilities and services in compliance with all requirements imposed by the Acts and Regulations (as may be amended) such that no person on the grounds of race, color, or national origin, will be excluded from participation in, denied the benefits of, or be otherwise subjected to discrimination in the use of said facilities.
- B. With respect to licenses, leases, permits, etc., in the event of breach of any of the above Nondiscrimination covenants, **COUNTY OF HIDALGO** will have the right to terminate the (lease, license, permit, etc.) and to enter, re-enter, and repossess said lands and facilities thereon, and hold the same as if the (lease, license, permit, etc.) had never been made or issued.*
- C. With respect to a deed, in the event of breach of any of the above Nondiscrimination covenants, the **COUNTY OF HIDALGO** will have the right to enter or re-enter the lands and facilities thereon, and the above described lands and facilities will there upon revert to and vest in and become the absolute property of the **COUNTY OF HIDALGO** and its assigns.*

(*Reverted clause and related language to be used only when it is determined that such a clause is necessary in order to make clear the purpose of Title VI.)

APPENDIX D

CLAUSES FOR CONSTRUCTION/USE/ACCESS TO REAL PROPERTY ACQUIRED UNDER THE ACTIVITY, FACILITY OR PROGRAM

The following clauses will be included in deeds, licenses, permits, or similar instruments/agreements entered into by **COUNTY OF HIDALGO** pursuant to the provisions of Assurance 7(b):

- A. The (grantee, licensee, permittee, etc., as appropriate) for himself/herself, his/her heirs, personal representatives, successors in interest, and assigns, as a part of the consideration hereof, does hereby covenant and agree (in the case of deeds and leases add, "as a covenant running with the land") that (1) no person on the ground of race, color, or national origin, will be excluded from participation in, denied the benefits of, or be otherwise subjected to discrimination in the use of said facilities, (2) that in the construction of any improvements on, over, or under such land, and the furnishing of services thereon, no person on the ground of race, color, or national origin, will be excluded from participation in, denied the benefits of, or otherwise be subjected to discrimination, (3) that the (grantee, licensee, lessee, permittee, etc.) will use the premises in compliance with all other requirements imposed by or pursuant to the Acts and Regulations, as amended, set forth in this Assurance.
- B. With respect to (licenses, leases, permits, etc.), in the event of breach of any of the above Nondiscrimination covenants, **COUNTY OF HIDALGO** will have the right to terminate the (license, permit, etc., as appropriate) and to enter or re-enter and repossess said land and the facilities thereon, and hold the same as if said (license, permit, etc., as appropriate) had never been made or issued.*
- C. With respect to deeds, in the event of breach of any of the above Nondiscrimination covenants, **COUNTY OF HIDALGO** will there upon revert to and vest in and become the absolute property of **COUNTY OF HIDALGO** and its assigns.*

(*Reverted clause and related language to be used only when it is determined that such a clause is necessary in order to make clear the purpose of Title VI.)

APPENDIX E

During the performance of this contract, the contractor, for itself, its assignees, and successors in interest (hereinafter referred to as the "contractor") agrees to comply with the following nondiscrimination statutes and authorities; including but not limited to:

Pertinent Nondiscrimination Authorities:

- Title VI of the Civil Rights Act of 1964 (42 U.S.C. § 2000d et seq., 78 stat. 252), (prohibits discrimination on the basis of race, color, national origin); and 49CFR Part 21.
- The Uniform Relocation Assistance and Real Property Acquisition Policies Act of 1970, (42U.S.C. § 4601), (prohibits unfair treatment of persons displaced or whose property has been acquired because of Federal or Federal-aid programs and projects);
- Federal-Aid Highway Act of 1973, (23U.S.C. § 324et seq.), (prohibits discrimination on the basis of sex);
- Section 504 of the Rehabilitation Act of 1973, (29U.S.C. § 794 et seq.), as amended, (prohibits discrimination on the basis of disability); and 49CFR Part 27;
- The Age Discrimination Act of 1975, as amended,(42U.S.C. § 6101 et seq.), (prohibits discrimination on the basis of age);
- Airport and Airway Improvement Act of 1982, (49U.S.C. § 4 71, Section 4 7123),as amended, (prohibits discrimination based on race, creed, color, national origin, or sex);
- The Civil Rights Restoration Act of 1987,(PL 100-209), (Broadened the scope, coverage and applicability of Title VI of the Civil Rights Act of 1964, The Age Discrimination Act of 1975 and Section 504 of the Rehabilitation Act of 1973, by expanding the definition of the terms "programs or activities" to include all of the programs or activities of the Federal-aid recipients, sub recipients and contractors, whether such programs or activities are Federally funded or not);
- Titles II and III of the Americans with Disabilities Act, which prohibit discrimination on the basis of disability in the operation of public entities, public and private transportation systems, places of public accommodation, and certain testing entities (42 U.S.C. §§ 12131-12189)as implemented by Department of Transportation regulations at 49C.F.R. parts 37 and 38;
- The Federal Aviation Administration's Nondiscrimination statute (49U.S.C. § 47123) (prohibits discrimination on the basis of race, color, national origin, and sex);
- Executive Order 12898, Federal Actions to Address Environmental Justice in Minority Populations and Low-Income Populations, which ensures discrimination against minority populations by discouraging programs, policies, and activities with disproportionately high and adverse human health or environmental effects on minority and low-income populations;
- Executive Order 13166, Improving Access to Services for Persons with Limited English Proficiency, and resulting agency guidance, national origin discrimination includes discrimination because of limited English proficiency (LEP). To ensure compliance with Title VI, you must take reasonable steps to ensure that LEP persons have meaningful access to your programs (70 Fed. Reg. at 74087 to 74100);
- Title IX of the Education Amendments of 1972, as amended, which prohibits you from discriminating because of sex in education programs or activities (20 U .S.C. 1681 et seq).



HIDALGO COUNTY
(Including all funding sources, programs, and entities)
REQUEST FOR BIDS
“PIPES & RELATED MISCELLANEOUS ITEMS”

RFB No.: 2017-046-04-05-FAZ

RFB SUBMITTAL CHECK LIST

All forms listed below must be included in the RFB response.

Indicate with a check mark (✓) the Forms completed and included in this response:

- Page 8 of Legal Notice
- Exhibit “B” Bid Page
- Exhibit “C” Acknowledgement forms
- Exhibit “D” CIQ Form -Copy of Co. Clerk Recording fee receipt (if applicable)
- Exhibit “E” Vendor Bidder Applications and IRS form W-9
- Exhibit “F” Certification Regarding Debarment
- SAMS.gov Registration Acknowledgement www.sam.gov
- One (1) Original, Three (3) Copies of Bid(s) (see No. 2 of Legal Notice).

EXHIBIT "B"
BID PAGE

EXHIBIT "B" - BID PAGE
Hidalgo County (All funding sources, programs & entities)
"PIPES & Related Miscellaneous Items"
RFB No.: 2017-046-04-05-FAZ

CATEGORY (A) - PIPES

CORRUGATED POLYVINYL CHLORIDE (PVC) STORM SEWER PIPE		
NIGP CODE: 665-89 Polyvinyl Chloride (PVC)		
DESCRIPTION	PRICE	
12"	<i>No Bid</i>	LF
15"		LF
18"		LF
24"		LF
30"		LF
36"		LF
42"		LF
48"		LF

CORRUGATED STEEL STORM SEWER PIPE			
NIGP CODE: 210-29 Corrugated Galvanized Metal Pipe			
(UNIT PRICE INCLUDES ONE GASKETED BAND CONNECTION FOR EVERY 20 FOOT JOINT)			
DIAMETER	TYPE "IR" PIPE PRICE	TYPE "I" PIPE PRICE	TYPE "IA" PIPE PRICE
12"			<i>No Bid</i>
15"			
18"			
24"			
30"			
36"			
42"			
48"			
54"			
60"			
66"			
72"			<i>9:54</i>
78"			
84"			<i>4-5-17</i>
90"			
96"			
102"			
108"			
114"			
120"			
126"			
132"			
138"			
144"			

EXHIBIT "B" - BID PAGE
Hidalgo County (All funding sources, programs & entities)
"PIPES & Related Miscellaneous Items"
RFB No.: 2017-046-04-05-FAZ

REINFORCED CONCRETE PIPE - RUBBER GASKET JOINT PIPE						
NIGP CODE: 658-68						
DESCRIPTION	CLASS III PRICE		CLASS IV PRICE		CLASS V PRICE	
12"	15.64	LF	20.10	LF	22.22	LF
15"	18.40	LF	23.28	LF	25.39	LF
18"	21.16	LF	26.45	LF	28.57	LF
24"	29.60	LF	33.86	LF	35.97	LF
30"	43.80	LF	47.49	LF	50.91	LF
36"	61.85	LF	67.71	LF	72.30	LF
42"	82.12	LF	83.05	LF	95.31	LF
48"	94.67	LF	104.74	LF	120.41	LF
54"	112.78	LF	128.34	LF	146.64	LF
60"	141.43	LF	159.51	LF	188.88	LF
72"	195.29	LF	225.18	LF	276.28	LF

REINFORCED CONCRETE PIPE - TONGUE & GROOVE PIPE						
NIGP CODE: 658-68						
DESCRIPTION	CLASS III PRICE		CLASS IV PRICE		CLASS V PRICE	
12"	12.88	LF	16.93	LF	18.22	LF
15"	15.64	LF	20.10	LF	21.25	LF
18"	18.40	LF	23.28	LF	24.29	LF
24"	26.00	LF	29.62	LF	30.36	LF
30"	39.68	LF	41.45	LF	50.37	LF
36"	54.37	LF	60.09	LF	70.57	LF
42"	73.98	LF	76.18	LF	85.29	LF
48"	93.21	LF	100.10	LF	113.24	LF
54"	109.49	LF	121.93	LF	137.07	LF
60"	135.22	LF	153.30	LF	174.65	LF
72"	195.29	LF	225.18	LF	254.98	LF

REINFORCED POLYETHYLENE PIPE - 20 FOOT JOINTS		
NIGP CODE: 658-58		
DESCRIPTION	PRICE	
24"	NO BID	LF
30"		LF
36"		LF
42"		LF
48"		LF
54"		LF
60"		LF
72"		LF
84"		LF
96"		LF

9:54
45-17
J

EXHIBIT "B" - BID PAGE
Hidalgo County (All funding sources, programs & entities)
"PIPES & Related Miscellaneous Items"
RFB No.: 2017-046-04-05-FAZ

AWWA C900 PVC PLASTIC PRESSURE PIPE						
NIGP CODE: 658-56 PLASTIC PIPES OR						
NIGP CODE: 658-60 PVC PIPES						
DESCRIPTION	DR 14 PRICE		DR 18 PRICE		DR 25 PRICE	
4"	NO BID	LF	NO BID	LF	NO BID	LF
6"	↓	LF	↓	LF	↓	LF
8"	↓	LF	↓	LF	↓	LF
10"	↓	LF	↓	LF	↓	LF
12"	↓	LF	↓	LF	↓	LF

AWWA C905 PVC PLASTIC WATER PIPE										
NIGP CODE: 658-56 PLASTIC PIPES OR										
NIGP CODE: 658-60 PVC PIPES										
DESCRIPTION	DR 18 PRICE		DR 25 PRICE		DR 32.5 PRICE		DR 41 PRICE		DR 51 PRICE	
14"	NO BID	LF	NO BID	LF	NO BID	LF	NO BID	LF	NO BID	LF
16"	↓	LF	↓	LF	↓	LF	↓	LF	↓	LF
18"	↓	LF	↓	LF	↓	LF	↓	LF	↓	LF
24"	↓	LF	↓	LF	↓	LF	↓	LF	↓	LF
30"	↓	LF	↓	LF	↓	LF	↓	LF	↓	LF
36"	↓	LF	↓	LF	↓	LF	↓	LF	↓	LF
42"	↓	LF	↓	LF	↓	LF	↓	LF	↓	LF
48"	↓	LF	↓	LF	↓	LF	↓	LF	↓	LF

SDR 26 AND SDR 35 GASKETED GRAVITY SANITARY SEWER PIPE				
NIGP CODE: 210-35				
SEWER PIPE JOINT SEALING COMPOUND				
SIZE OF PIPE	SDR 26		SDR 35	
4"	NO BID	LF	NO BID	LF
6"	↓	LF	↓	LF
8"	↓	LF	↓	LF
10"	↓	LF	↓	LF
12"	↓	LF	↓	LF
15"	↓	LF	↓	LF

HIGH PERFORMANCE (HP) POLYPROPYLENE STORM PIPE		
DESCRIPTION	PRICE	
12"	NO BID	LF
15"	↓	LF
18"	↓	LF
24"	↓	LF
30"	↓	LF
36"	↓	LF
42"	↓	LF
48"	↓	LF
60"	↓	LF

EXHIBIT "B" - BID PAGE
 Hidalgo County (All funding sources, programs & entities)
 "PIPES & Related Miscellaneous Items"
 RFB No.: 2017-046-04-05-FAZ

HIGH DESTINY POLYETHYLENE PIPE (HDPE)		
NIGP CODE: 658-58 Polyethylene Pipe And Fitting		
DESCRIPTION	PRICE	
4"	NO BID ↓	LF
6"		LF
8"		LF
10"		LF
12"		LF
15"		LF
18"		LF
24"		LF
30"		LF
36"		LF
42"		LF
48"		LF
54"		LF
60"		LF

PLUMBING PIPES - 20 FOOT SECTIONS		
NIGP CODE: 967-60		
PVC	PRICE	
1/2"	NO BID ↓	
1 1/2"		
2"		
3"		
4"		

(C) 2017
 9:54
 4-5-17
 Winters

PLUMBING PIPES - 20 FOOT SECTIONS		
NIGP CODE: 967-60		
COPPER	PRICE	
1/2"	NO BID ↓	
3/4"		

g

EXHIBIT "B" - BID PAGE
 Hidalgo County (All funding sources, programs & entities)
 "PIPES & Related Miscellaneous Items"
 RFB No.: 2017-046-04-05-FAZ

CATEGORY (B) - INLETS

NIGP CODE: 210-31

INLETS, AREA, SEWER DRAIN, PRECAST, CONCRETE, STORM DRAIN, NO BOTTOM FLOORS

DESCRIPTION	PRICE																
	2'	2 1/2'	3'	3 1/2'	4'	4 1/2'	5'	5 1/2'	6'	6 1/2'	7'	7 1/2'	8'	8 1/2'	9'	9 1/2'	10'
Type "A" Inlet (5' x 3')	<i>See attached</i>																
Type "A-1" Inlet (5' x 4')	<i>See attached</i>																
Type "A-2" Inlet (5' x 5')	<i>See attached</i>																
Type "A-3" Inlet (5' x 6')	<i>See attached</i>																
Type "A" (SPL-1) Inlet (5' x 3')	<i>NO BID</i>																
Type "A-1" (SPL-1) Inlet (5' x 4')	<i>NO BID</i>																
Type "A-2" (SPL-1) Inlet (5' x 5')	<i>NO BID</i>																
Type "A-3" (SPL-1) Inlet (5' x 6')	<i>NO BID</i>																
TYPE "C" INLET 2' X 2'	<i>See attached</i>																
TYPE "C" INLET 3' X 3'	<i>See attached</i>																
TYPE "C" INLET 4' X 4'	<i>See attached</i>																
TYPE "CC" INLET 5' X 3'	<i>See attached</i>																

9:54
4-5-17
W/...

[Signature]

Type A Curb Inlet

SIZE	BOX COMBO FOR SIZING		COMPLETE PRICING
2.5'	-	-	\$ 904.14
3.0'	-	-	\$ 908.98
3.5'	-	-	\$ 928.50
4.0'	-	-	\$ 968.58
4.5'	-	-	\$ 1,023.16
5.0'	-	-	\$ 1,079.06
5.5'	-	-	\$ 1,143.25
6.0'			\$ 1,224.10
6.5'			\$ 1,293.84
7.0'			\$ 1,363.59
7.5'			\$ 1,430.57
8.0'			\$ 1,483.68
8.5' *	5.0'	3.5'	\$ 1,501.12
9.0' *	5.0'	4.0'	\$ 1,516.34
9.5' *	5.0'	4.5'	\$ 1,570.92
10.0' *	5.0'	5.0'	\$ 1,626.82

* these sizes use a combination of boxes to achieve height

04/05/17

9.54

4-5-17

Witnessed



Type C 2x2 - GRATE Inlet

SIZE	BOX COMBO FOR SIZING		COMPLETE PRICING
2.5'			\$ 640.02
3.0'			\$ 696.79
3.5'			\$ 753.57
4.0'			\$ 806.78
4.5'			\$ 863.57
5.0'			\$ 916.78
5.5'			\$ 973.56
6.0'			\$ 1,026.77
6.5'			\$ 1,090.67
7.0'			\$ 1,136.77
7.5'			\$ 1,193.55
8.0'			\$ 1,246.76
8.5' *	5.0'	3.5'	\$ 1,303.55
9.0' *	5.0'	4.0'	\$ 1,356.76
9.5' *	5.0'	4.5'	\$ 1,413.55
10.0' *	5.0'	5.0'	\$ 1,466.76

* these sizes use a combination of boxes to achieve height

03/11/17

9:54

4-5-17

Witnessed

[Handwritten Signature]

Type C 3X3 - GRATE Inlet

SIZE	BOX COMBO FOR SIZING		COMPLETE PRICING
2.5'			\$ 829.80
3.0'			\$ 901.51
3.5'			\$ 973.21
4.0'			\$ 1,044.91
4.5'			\$ 1,116.61
5.0'			\$ 1,188.31
5.5'			\$ 1,260.01
6.0'			\$ 1,331.71
6.5'			\$ 1,403.41
7.0'			\$ 1,475.11
7.5'			\$ 1,546.81
8.0'			\$ 1,618.51
8.5' *	5.0'	3.5'	\$ 1,690.22
9.0' *	5.0'	4.0'	\$ 1,761.92
9.5' *	5.0'	4.5'	\$ 1,833.62
10.0' *	5.0'	5.0'	\$ 1,905.32

* these sizes use a combination of boxes to achieve height

OPENED

9:54

4-5-17

Witnessed

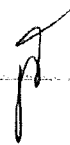

Type C 4x4 - GRATE Inlet

SIZE	BOX COMBO FOR SIZING		COMPLETE PRICING
2.5'			\$ 1,136.62
3.0'			\$ 1,240.17
3.5'			\$ 1,347.26
4.0'			\$ 1,450.81
4.5'			\$ 1,554.35
5.0'			\$ 1,661.45
5.5'			\$ 1,764.99
6.0'			\$ 1,868.53
6.5'			\$ 1,972.07
7.0'			\$ 2,079.17
7.5'			\$ 2,182.71
8.0'			\$ 2,286.26
8.5' *	5.0'	3.5'	\$ 2,396.91
9.0' *	5.0'	4.0'	\$ 2,500.46
9.5' *	5.0'	4.5'	\$ 2,604.00
10.0' *	5.0'	5.0'	\$ 2,711.10

* these sizes use a combination of boxes to achieve height

(continued)

9:54

4-5-17

Witnessed



Type "CC" Precast Double Grate Inlet Complete

SIZE	BOX COMBO FOR SIZING		COMPLETE PRICING
2.5'			\$ 1,262.14
3.0'			\$ 1,267.29
3.5'			\$ 1,288.03
4.0'			\$ 1,303.28
4.5'			\$ 1,357.86
5.0'			\$ 1,413.76
5.5'			\$ 1,477.95
6.0'			\$ 1,558.80
6.5'			\$ 1,628.54
7.0'			\$ 1,698.29
7.5'			\$ 1,765.27
8.0'			\$ 1,818.38
8.5' *	5.0'	3.5'	\$ 1,835.79
9.0' *	5.0'	4.0'	\$ 1,851.04
9.5' *	5.0'	4.5'	\$ 1,905.62
10.0' *	5.0'	5.0'	\$ 1,961.52

* these sizes use a combination of boxes to achieve height

COMPLETED

9:54

4-5-17

Witnessed

J

**48" MH(Type "A") Precast
Manhole Complete**

SIZE	COMPLETE PRICING
3.0'	\$ 596.40
3.5'	\$ 650.40
4.0'	\$ 703.55
4.5'	\$ 739.55
5.0'	\$ 789.20
5.5'	\$ 825.20
6.0'	\$ 881.80
6.5'	\$ 917.80
7.0'	\$ 970.90
7.5'	\$ 1,006.90
8.0'	\$ 1,060.05
8.5'	\$ 1,096.05
9.0'	\$ 1,145.70
9.5'	\$ 1,181.70
10.0'	\$ 1,288.30

**60" MH(Type "A-1")
Precast Manhole Complete**

SIZE	COMPLETE PRICING
3.0'	\$ 747.05
3.5'	\$ 765.05
4.0'	\$ 801.05
4.5'	\$ 903.05
5.0'	\$ 939.05
5.5'	\$ 998.50
6.0'	\$ 1,034.50
6.5'	\$ 1,171.00
7.0'	\$ 1,207.00
7.5'	\$ 1,306.70
8.0'	\$ 1,342.70
8.5'	\$ 1,444.70
9.0'	\$ 1,480.70
9.5'	\$ 1,540.15
10.0'	\$ 1,576.15

(REMOVED)
 9:54
 4-5-17
 Wilmsco

EXHIBIT "B" - BID PAGE
Hidalgo County (All funding sources, programs & entities)
"PIPES & Related Miscellaneous Items"
RFB No.: 2017-046-04-05-FAZ

CATEGORY (D) - MISCELLANEOUS

DESCRIPTION		
WATER VALVE	UNIT	PRICE
2"	EA	NO BID
4"	EA	↓
6"	EA	
8"	EA	
10"	EA	
90 DEGREE ELBOW		
2"	EA	
4"	EA	
6"	EA	
8"	EA	
10"	EA	
45 DEGREE ELBOW		
2"	EA	
4"	EA	
6"	EA	
8"	EA	
10"	EA	
STEEL PIPE CASING WITH SPACERS		
4"	LF	
6"	LF	
12"	LF	
16"	LF	
24"	LF	
FIRE HYDRANT W/VALVE	EA	
PVC SCHEDULE 40 WATER LINE DR 18		
2"	LF	
8"	LF	
PVC SCHEDULE 40		
1.5"	LF	
0.75"	LF	
0.5"	LF	
WATER SADDLE W/2' CORPORATE VALVE		
8" x 2"	EA	↓

(OVERLAP)

9:54

4-5-17

Withessed

g

EXHIBIT "B" - BID PAGE
Hidalgo County (All funding sources, programs & entities)
"PIPES & Related Miscellaneous Items"
RFB No.: 2017-046-04-05-FAZ

HP Dual Wall Marmac Couplers		
PIPE SIZE	PRICE	UNIT
12"	No BID ↓	EA
15"		EA
18"		EA
24"		EA
30"		EA
36"		EA
42"		EA
48"		EA
60"		EA

HP Dual Wall Fabricated Tees		
PIPE SIZE	PRICE	UNIT
12"	No BID ↓	EA
15"		EA
18"		EA
24"		EA
30"		EA
36"		EA
42"		EA
48"		EA
60"		EA

HP Dual Wall Fabricated Bends						
PIPE SIZE	11.25 Bend	22.5 Bend	30* Bend	45* Bend	90* Bend	Unit
12"	No BID ↓	↓	↓	↓	↓	EA
15"						EA
18"						EA
24"						EA
30"						EA
36"						EA
42"						EA
48"						EA
60"						EA

EXHIBIT "B" - BID PAGE
Hidalgo County (All funding sources, programs & entities)
"PIPES & Related Miscellaneous Items"
RFB No.: 2017-046-04-05-FAZ

BIDDER/COMPANY NAME: Rio Valley Pipe LLC dba CAPA
ADDRESS: 3609 W. Palma Vista Dr.
CITY: Palmview STATE: TX ZIP CODE: 78157
PHONE No: (956) 580-2503 FAX No: (956) 583-2086 CELL No: -
AUTHORIZED SIGNATURE: 
PRINTED NAME: Larry Hinojosa
TITLE: Sales Administrator DATE: 4-4-17
EMAIL: sales@capa-texas.com

EXHIBIT "C"
CERTIFICATE OF INSURANCE



CERTIFICATE OF LIABILITY INSURANCE

DATE (MM/DD/YYYY)
2/22/2017

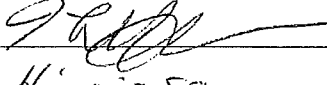
THIS CERTIFICATE IS ISSUED AS A MATTER OF INFORMATION ONLY AND CONFERS NO RIGHTS UPON THE CERTIFICATE HOLDER. THIS CERTIFICATE DOES NOT AFFIRMATIVELY OR NEGATIVELY AMEND, EXTEND OR ALTER THE COVERAGE AFFORDED BY THE POLICIES BELOW. THIS CERTIFICATE OF INSURANCE DOES NOT CONSTITUTE A CONTRACT BETWEEN THE ISSUING INSURER(S), AUTHORIZED REPRESENTATIVE OR PRODUCER, AND THE CERTIFICATE HOLDER.

IMPORTANT: If the certificate holder is an ADDITIONAL INSURED, the policy(ies) must be endorsed. If SUBROGATION IS WAIVED, subject to the terms and conditions of the policy, certain policies may require an endorsement. A statement on this certificate does not confer rights to the certificate holder in lieu of such endorsement(s).

PRODUCER McAfee Insurance Agency P. O. Box 625 321 Second Street Mercedes TX 78570	CONTACT NAME: Consuelo Cavazos, CISR PHONE (A/C, No. Ext): (956) 565-2481 FAX (A/C, No): (956) 565-2733 E-MAIL ADDRESS: consuelo@mcafeeagency.com													
	<table border="1"> <tr> <th>INSURER(S) AFFORDING COVERAGE</th> <th>NAIC #</th> </tr> <tr> <td>INSURER A: Ironshore Specialty Ins. Co</td> <td></td> </tr> <tr> <td>INSURER B: National Liability & Fire Ins</td> <td></td> </tr> <tr> <td>INSURER C: Texas Mutual Ins. Co.</td> <td></td> </tr> <tr> <td>INSURER D:</td> <td></td> </tr> <tr> <td>INSURER E:</td> <td></td> </tr> <tr> <td>INSURER F:</td> <td></td> </tr> </table>	INSURER(S) AFFORDING COVERAGE	NAIC #	INSURER A: Ironshore Specialty Ins. Co		INSURER B: National Liability & Fire Ins		INSURER C: Texas Mutual Ins. Co.		INSURER D:		INSURER E:		INSURER F:
INSURER(S) AFFORDING COVERAGE	NAIC #													
INSURER A: Ironshore Specialty Ins. Co														
INSURER B: National Liability & Fire Ins														
INSURER C: Texas Mutual Ins. Co.														
INSURER D:														
INSURER E:														
INSURER F:														
INSURED Rio Valley Pipe, LLC 3609 West Palma Vista Drive Palmview TX 78572-1861														

COVERAGES **CERTIFICATE NUMBER: 2017-2018** **REVISION NUMBER:**

THIS IS TO CERTIFY THAT THE POLICIES OF INSURANCE LISTED BELOW HAVE BEEN ISSUED TO THE INSURED NAMED ABOVE FOR THE POLICY PERIOD INDICATED. NOTWITHSTANDING ANY REQUIREMENT, TERM OR CONDITION OF ANY CONTRACT OR OTHER DOCUMENT WITH RESPECT TO WHICH THIS CERTIFICATE MAY BE ISSUED OR MAY PERTAIN, THE INSURANCE AFFORDED BY THE POLICIES DESCRIBED HEREIN IS SUBJECT TO ALL THE TERMS, EXCLUSIONS AND CONDITIONS OF SUCH POLICIES. LIMITS SHOWN MAY HAVE BEEN REDUCED BY PAID CLAIMS.

INSR LTR	TYPE OF INSURANCE	ADDL INSP	SUBR WVD	POLICY NUMBER	POLICY EFF (MM/DD/YYYY)	POLICY EXP (MM/DD/YYYY)	LIMITS
A	<input checked="" type="checkbox"/> COMMERCIAL GENERAL LIABILITY <input type="checkbox"/> CLAIMS-MADE <input checked="" type="checkbox"/> OCCUR GENL AGGREGATE LIMIT APPLIES PER: <input type="checkbox"/> POLICY <input checked="" type="checkbox"/> PRO-JECT <input type="checkbox"/> LOC OTHER:			003075700	2/22/2017	2/22/2018	EACH OCCURRENCE \$ 1,000,000 DAMAGE TO RENTED PREMISES (Ea occurrence) \$ 500,000 MED EXP (Any one person) \$ 25,000 PERSONAL & ADV INJURY \$ 1,000,000 GENERAL AGGREGATE \$ 2,000,000 PRODUCTS - COM/POP AGG \$ 2,000,000 Employee Benefits \$ 1,000,000
B	AUTOMOBILE LIABILITY <input type="checkbox"/> ANY AUTO <input type="checkbox"/> ALL OWNED AUTOS <input checked="" type="checkbox"/> SCHEDULED AUTOS <input checked="" type="checkbox"/> HIRED AUTOS <input checked="" type="checkbox"/> NON-OWNED AUTOS			73TR8073449	2/22/2017	2/22/2018	COMBINED SINGLE LIMIT (Ea accident) \$ 1,000,000 BODILY INJURY (Per person) \$ BODILY INJURY (Per accident) \$ PROPERTY DAMAGE (Per accident) \$ \$
A	<input type="checkbox"/> UMBRELLA LIAB <input checked="" type="checkbox"/> OCCUR <input checked="" type="checkbox"/> EXCESS LIAB <input type="checkbox"/> CLAIMS-MADE <input type="checkbox"/> DED <input type="checkbox"/> RETENTIONS \$			003075800	2/22/2017	2/22/2018	EACH OCCURRENCE \$ 1,000,000 AGGREGATE \$ 1,000,000 \$
C	WORKERS COMPENSATION AND EMPLOYERS' LIABILITY ANY PROPRIETOR/PARTNER/EXECUTIVE OFFICER/MEMBER EXCLUDED? (Mandatory in NH) If yes, describe under DESCRIPTION OF OPERATIONS below		Y/N N/A	0001198034	10/27/2016	10/27/2017	<input checked="" type="checkbox"/> PER STATUTE <input type="checkbox"/> OTH-ER E.L. EACH ACCIDENT \$ 1,000,000 E.L. DISEASE - EA EMPLOYEE \$ 1,000,000 E.L. DISEASE - POLICY LIMIT \$ 1,000,000

DESCRIPTION OF OPERATIONS / LOCATIONS / VEHICLES (ACORD 101, Additional Remarks Schedule, may be attached if more space is required)
Contract No. C-15-013A-04-28 "Pipes and Miscellaneous Items" Hidalgo County

CERTIFICATE HOLDER Hidalgo County Purchasing Department 2802 S Business Hwy 281 Edinburg, TX 78539	CANCELLATION SHOULD ANY OF THE ABOVE DESCRIBED POLICIES BE CANCELLED BEFORE THE EXPIRATION DATE THEREOF, NOTICE WILL BE DELIVERED IN ACCORDANCE WITH THE POLICY PROVISIONS. AUTHORIZED REPRESENTATIVE Robert R Garza/CO <i>Robert R Garza</i>
--	---



All Valley Trucking, LLP
 Upper Valley Materials LLC
 Rio Valley Pipe, LLC
 DBA CAPA
 3609 West Palm Vista Drive
 Palmview, TX 78572

June 16, 2016

Reference: Business Auto Policy # 73TRS060979
 Effective 2/22/2016 to 2/22/2017

To: Larry Hinojosa

As per our request, below is the current list of scheduled vehicles on the following policy:

*Vehicle #	Cust Veh #	Year	Make	Model	VIN
00001	R	2008	Chevrolet	Silverado	3GCEC13J88G141932
00002	R	2008	Chevrolet	Silverado	1GCEC19018Z146193
00003	R	2008	Chevrolet	Silverado	2GCEC13J381188942
00004	R	2005	Ford	F150	1FTRX12W25NA13479
00005	R	2005	Ford	F150	1FTRF12225NA08525
00006	R	2005	Ford	F150	1FTRF12225NA09612
00007	R	2005	Ford	F150	1FTRX12W95NA11101
00008	R	2005	Ford	F150	1FTRF12225NA49799
00009	R	1992	Ford	Superduty	2FDLF47GXNCA30267
00010	R	2011	Chevy	Silverado	3GCPCSE01BG182395
00011	A	1998	Freightliner	Tractor	1FUYPYB4WL837260



00012	A	1998	Mack		IM2AA13Y9WW091599
00013	A	1992	Fontaine	Flatbed	13N148302N1554687
00014	A	1999	Mack	Truck Tractor	IM2AA13YXXW111389
00015	A	1992	Fontaine	Flatbed	13N148300N1554641
00016	A	1999	Mack	Truck Tractor	IM2AA13Y6XW111390
00017	A	1992	Fontaine	Flatbed	13N148304N1554657
00018	A	1965	Load Craft	Lowboy	CA65098
00019	A	1996	Mack	Truck Tractor	1M1AA13Y7TW059590
00020	A	1998	Mack		IM2AA13Y5WW093480
00021	A	1998	Mack		IM2AA13Y9WW093482
00022	A	1980	Rogers	Lowboy	18805
00023	A	2000	Mack		1M1AA13Y5YW116716
00024	A	1999	Mack		1M1AA13Y4XW106807
00025	A	1999	Mack		1M1AA13Y8XW112626
00026	A	1998	Mack		1M1AA18Y1WW082635
00027	A	2002	Mack	CX613 T/A	1M1AE07Y92W012939
00028	A	2002	Mack	CX613 T/A	1M1AE07YX2W012920
00029	A	2002	Mack	CX613 T/A	1M1AE07Y62W012932
00030	A	1973	Hyster	Trailer	TR136827



00031	A	2002	Mack	CX613 T/A	1M1AE07Y72W012941
00032	A	1994	Utility Trailer		1UYF52481RA152703
00033	A	1994	Utility Trailer		1UFS2489RA152707
00034	A	2001	International	4,000 Gal	2HSCEAHRX1C020829
00035	A	1980	Transcraft	Trailer	TC14923
00036	A	1991	Dorsey	Trailer	1DTP16W28MP029595
00037	A	1980	Transcraft	Lowboy	TC14575
00038	A	1979	Transcraft	Lowboy	TC12951
00039	A	1993	Ramco		8760
00040	A	1992	Ramco		8505
00041	A	1998	Vantage	Tank	4EPPA4126WBBA2179
00042	A	1973	Freuhauf	Lowboy	FWR406205
00043	A	1990	Fruehauf		1H4B04222LL029001
00044	A	1984	Heil	Pneumatic	1HLS1M7B2E7T00208
00045	A	2006	Mack	Truck Tractor	1M2AL02Y46M003768
00046	A	2006	Clement	End Dump	5C2BB38BX6M005204
00047	A	2010	Mack	CXU613	1M1AW02Y5AN010579
00048	A	2006	Mack	Truck Tractor	1M2AL02Y66M003769



00049	A	2010	Mack	CXU613	1M1AW02Y9AN010584
00050	A	2010	Mack	CXU613	1M1AW02Y0AN010585
00051	A	2006	Mack	Truck Tractor	1M2AL02Y26M003770
00052	A	2010	Vantage	Pneumatic Trailer	4E7PA4222BABA2775
00053	A	2006	Mack	Truck Tractor	1M2AL02Y46M003771
00054	A	2006	Mack	Truck Tractor	1M2AL02Y66M003772
00055	A	2001	Mack	600	1M1AA12Y11W141443
00056	A	2006	Haul	Flatbed	5JYLB35296P061934
00057	A	2006	Mack	Truck Tractor	1M2AL02Y86M003773
00058	A	2011	Vantage	Trailer	4E7PA4224BABA2776
00059	A	2006	Clement	End Dump	5C2BB38B16M005205
00060	A	2011	Vantage	Trailer	4E7PA4226BABA2777
00061	A	2006	Clement	End Dump	5C2BB38B76M005290
00062	A	2006	Clement	End Dump	5C2BB38B96M005291
00063	A	2009	Mack	GU813	1M1AX16Y59M009477
00064	A	2006	Clement	End Dump	5C2BB38B06M005292
00065	A	2009	Mack	GU813	1M1AX16Y79M009478
00066	A	2006	Vantage	Bulk	4E7PA42276PBA1110
00067	A	2006	Vantage	Bulk	4E7PA42226PBA1113



00068	A	2009	Mack	GU813	1M1AX16Y99M009479
00069	A	2009	Mack	GU813	1M1AX16Y59M009480
00070	A	1978	Load	Lowboy	CJ781607
00071	A	1980	Fruehauf	FB	0MT010814
00072	A	2011	Clement	Starlite	5C2BB38B3BM007225
00073	A	2011	Clement	Starlite	5C2BB38B9BM007228
00074	U	1993	Ramco		1R9BSE502TL008761
00075	A	2011	Clement	Starlite	5C2BB38B8BM007348
00076	A	2011	Clement	Starlite	5C2BB38B0BM007229
00077	A	1987	Transcraft	45' Spreadaxle Flatbed	1TTF45202H1028658
00078	A	1979	Great Dane	45' T/A Flatbed	M22567
00079	A	2007	CTS	Bottom Dump Trailer	5TU1140267S000344
00080	A	2007	CTS	Bottom Dump Trailer	5TU1140227S000339
00081	A	2007	CTS	Bottom Dump Trailer	5TU1140207S000338
00082	A	2007	CTS	Bottom Dump Trailer	5TU11402X7S000377
00083	A	2007	CTS	Bottom Dump Trailer	5TU1140217S000378
00084	A	1998	Freightliner		1FUYPDYBXWL837246
00085	A	1997	Mack	Dump Truck	1M1AA12Y3VW079873
00086	A	2008	Mack	GU813	1M1AX16Y08M001382



00087	A	2008	Mack	GU713	1M1AX09Y38M002466
00088	A	2008	Mack	GU713	1M1AX09Y58M002467
00089	A	2007	Mack	CXN613	1M1AK06Y37N020543
00090	A	2008	Mack	GU713	1M2AX07Y78M003490
00091	U	2008	Ford	F250	1FTSW21RX8EA91079
00092	U	2008	Toyota	Pick Up	3TMKU72N28M015378
00093	U	1999	Chevrolet	C-15 Fleets	1GCEC14W4YF124658
00094	U	2000	Chevrolet	1500 Fleets	2GCEK19T4Y1192526
00095	U	2005	Ford	F150	1FTRF12215NA02036
00096	U	2007	Mercedes	Benz S550	WDDNG71X77A028734
00097	U	2005	Ford	F150	1FTRF12235NA52548
00098	U	1999	Ford	F550	1FDAF56S9XED93966
00099	U	2004	Chevy	Van	1GCGG25UX41246488
00100	U	2004	Chevy	Van	1GCGG25UX41166527
00101	U	1994	Chevy		1GBP7H1J5RJ102860
00102	U	1999	Chevrolet	suburban	3GNFK16R7XG189727
00103	U	2012	Chevrolet	Silverado	3GCPCSE09CG131793
00104	U	2013	Chevy	Silverado	3GCPCPEA5DG121477
00105	U	2013	Chevy	Silverado	1GCNCPEA4CZ350528



00106	A	1982	Fontaine	Trailer	1A11422CBC1536177
00107	A	2007	Dodge	Ram	3D7ML46D27G812860
00108	A	1990	Mack	Dump Truck	1M2AA06Y9LW005046
00109	U	1999	Ford		1FDWF36L8XEE75903
00110	A	2012	Peterbilt	367	1XPTD49X9CD144084
00111	A	2012	Peterbilt	367	1XPTD49X0CD144085
00112	A	2012	Peterbilt	367	1XPTD49X2CD144086
00113	A	2012	Peterbilt	367	1XPTD49X8CD144089
00114	A	2012	Peterbilt	367	1XPTD49X4CD144090
00115	U	1998	International	Harvester	1HTSCABNIWH526021
00116	R	2014	Chevrolet	Silverado 1500	3GCPCREC9FG389561
00117	R	2014	Chevrolet	Silverado 1500	3GCPCREC3EG428919
00118	A	1996	International	Flatbed	1HTSCAAN3TH263527
00119	A	1997	Ford	Louisville	1FDXN80E0VVA34925
00120	A	1979	Tanker		T41495
00121	A	1979	Tanker		T40807
00122	A	2015	Directrailer	Loadstar Flatbed	5UJFS4821FE002572
00123	A	2015	Directrailer	Loadstar Flatbed	5UJFS4823FE002573
00124	A	2015	Directrailer	Loadstar Flatbed	5UJFS4825FE002574



00125	A	2015	Directrailer	Loadstar Flatbed	5UJFS482XFE002571
00126	A	2015	Directrailer	Loadstar Flatbed	5UJFS4828FE002570
00127	A	2015	Directrailer	Loadstar Drop Deck	5UJDS4820FE002568
00128	A	2015	Directrailer	Loadstar Drop Deck	5UJDS4822FE002569
00129	U	1989	BMV	Harsco M930	1044AA019
00130	A	2014	Exa	Pneumatic Tank	3E9J158J2ET034284
00131	A	2014	Exa	Pneumatic Tank	3E9J158J4ET034285
00132	R	2014	Dodge	Ram	3C63RRAL7EG154165
00133	A	2013	Peterbilt	386	1XPHD49X3DD163883
00134	A	2013	Peterbilt	386	1XPHD49X0DD213994
00135	A	2013	Peterbilt	386	1XPHD49X7DD213992
00136	A	2013	Peterbilt	386	1XPHD49X2DD213995
00137	A	2013	Peterbilt	386	1XPHD49X9DD213993
00138	A	1989	Lufkin	Flat Bed	1L01B4526K1082489
00139	A	2015	CTS	End Dump	5TU343727FS000836
00140	A	2015	CTS	End Dump	5TU343729FS000837
00141	A	2015	CTS	End Dump	5TU343720FS000838
00142	A	2015	CTS	End Dump	5TU343729FS000840
00143	A	2015	CTS	End Dump	5TU343720FS000841



00144	U	2001	Peterbilt	330	2NPNLD9X51M560792
00145	R	2008	Ford	F250	1FTSX20548ED54730
00146	R	2010	Ford	F150 King Ranch	1FTFW1EV1AKE33903
00147	A	2008	Ford	F150	1FDAF56R88ED21719
00148	U	2004	Mack	CV713 T/A Fuel & Lube	1M2AG11C74M014079
00149	A	2016	Freightliner	Cascadia	3AKJGBDV6GDGY9959
00150	A	2016	Freightliner	Cascadia	3AKJGBDV2GDGY9960
00151	A	2016	Freightliner	Cascadia	3AKJGBDV4GDGY9961
00152	A	2016	Freightliner	Cascadia	3AKJGBDV6GDGY9962
00153	A	2016	Freightliner	Cascadia	3AKJGBDV8GDGY9963
00154	A	2016	Freightliner	Cascadia	3AKJGBDVXGDGY9964
00155	A	2015	Polar APXS	Aluminum Pneumatic	1PMB14121F5013781
00156	A	2015	Polar APXS	Aluminum Pneumatic	1PMB14128F5013440
00157	A	2015	Polar APXS	Aluminum Pneumatic	1PMB14121F5013778
00158	A	2016	Freightliner	Cascadia	3AKJGBDV6GDGY7077
00159	A	2016	Freightliner	Cascadia	3AKJGBDV8GDGY7078
00160	A	2016	Freightliner	Cascadia	3AKJGBDVXGDGY7079
00161	A	2016	Freightliner	Cascadia	3AKJGBDV6GDGY7080
00162	A	2016	Freightliner	Cascadia	3AKJGBDVXGSGY4310



00163	A	2016	Freightliner	CA113DC	3AKJGBDV3GDHG5486
00164	A	2016	Freightliner	CA113DC	3AKJGBDV5GDGY9967
00165	U	2012	International	4300	1HTMMAAM4CH435805
00166	U	2006	Freightliner	M2 100	1FVACWCS96HW72987
00167	R	2013	Ford	F150	1FTEX1CM9DFA94047
00168	A	1999	Fontaine	TA50NGB	4LF4S5033X3507900
00169	P	2014	MAC	GT16SFC	1M9PT2021EB618522
00170	P	2012	Wylie	500 Gallon	5VUTE1327CP000010
00171	U	2001	Freightliner	FL70 1950 Gallon S/A Asphalt	1FVABTBV01DH31604
00172	R	2016	GMC	Sierra	1GTP1MEC8GG141664
00173	R	2016	GMC	Sierra	3GTP1MEC7GG125735
00174	A	2012	Vantage P42	Pneumatic Bulk Trailer	4E7PA4225CABA3145
00175	A	2012	Vantage P42	Pneumatic Bulk Trailer	4E7PA4223CABA3158
00176	A	2012	Vantage P42	Pneumatic Bulk Trailer	4E7PA4225CABA3162

Let me know if you need any additional information

Thank you
 Consuelo Cavazos Lorenzana

7. AI-59945 Pct. #1:

OK
3/2

Acceptance and approval for items under Contract #C-16-363-11-01 between Hidalgo County [Pct. #1] ASAGO LLC, dba, ASAGO Construction for the FEMA Road & Drainage Improvements: Mile 2.5 East Road including but not limited to the following:

- A. Certificate of Substantial Completion reflecting the date of May 11, 2017; and,
- B. Payment Application No. 6 (Retainage) in the amount of \$23,421.33.

D. Pct. 3

OK

1. AI-60010 A. Requesting approval of "Supplemental Agreement No. 1" as submitted by L&G Engineering Contract C-15-161-11-17 to extend the project limits as requested by the Texas Department of Transportation, to include the section from IH2 (US83) on Abram Road North to Veterans Blvd. (approximately 0.2 Miles), thence East to SH 364 (La Homa);

B. Acceptance and approval of Work Authorization No. 2 (with an estimated cost of \$1,321,800.00) as submitted by project engineer, L&G Consulting Engineers, Inc. dba L&G Engineering for, "PS&E, Surveys, Right-of-Way Map and Permitted Utilities Coordination for the Veterans Boulevard (SH 495) project from IH2 (US83) to La Homa Road (SH 364)" located in Precinct 3 through Contract # C-15-161-11-17;

C. Pursuant to contract with L&G Engineering, (Article 14) to C-15-161-11-17, approval to permit the subcontracting of R.O.W. Surveying Services, LLC and Ergonomic Transportation Systems, Inc. for the Veterans Boulevard Project.

2. AI-59931 Requesting approval of a professional appraisal services agreement with CruzBro RGV, LLC dba The Real Estate Center for the purposes of appraisal services for: The Fair Market Value Appraisals in connection with the Acquisition of Land-Sale and/or Exchange, Rights of Way, Easements, Condemnations and Disposition of County owned Property located within Hidalgo County Precinct No. 3 (on an as needed basis) and as selected for negotiations by CC from the "POOL" of Appraisers by CC on 2/21/17.

E. Pct. 4

OK

1. AI-59993 Acceptance and approval of Change Order No. 10 (decrease) for deduction of Landscaping Allowance to zero-out Contract No. C-14-067-06-03 with JCon Construction, LLC. as reviewed/approved by project architect of record, Mata-Garcia Architects, LLP for: Hidalgo County Precinct No. 4 Project: Construction of the Linn-San Manuel Emergency Services Facilities with authority for County Judge, or Court Member to execute document.

F. Health & Human Services Dept.

OK

1. AI-60003 Requesting authority to advertise and procurement packet [drafted/developed by HC-DH&HS & Purchasing Dept.] the project titled: "Online Pharmacy Billing Services" - RFP No.: 2017-149-06-21-HGO for County Indigent Health Care Level 2 Pilot Program with draft contract document subject to final legal review/approval.

*Pct. 1
abstain*

G. Co. Wide

OK

1. AI-59743 Presentation of Bids received (as detailed in tabulation sheet contained herein) for the purpose of award to the responsible multiple vendors submitting the lowest and best bids (including meeting specifications and/or requirements) with approval of contract document for project

titled: Hidalgo County "Pipes & Related Miscellaneous Items" through RFB No.: 2017-046-04-05-FAZ as follow:

- A. Rio Valley Pipe, LLC d/b/a CAPA;
- B. HD Supply Waterworks, LTD
- C. Act Pipe & Supply, Inc.
- D. Ferguson Enterprises d/b/a Ferguson Waterworks
- E. Aguaworks Pipe & Supply, LLC

23. Open Forum

1 Leslie Salinas Re: public lighting/HKS to Pct. 3
2 Beth Barnes Re: CC mtgs. starts late

24. Closed Session:

Commissioners' Court may go into Closed Session pursuant to Chapter 551, Texas Government Code, Sections 551.071 & 551.072 to discuss the following:

- A. Real Estate Acquisition *in @ 12:37*
- B. Pending and/or potential litigation *out @ 1:09*
- C. AI-59997 Pending/potential litigation - Edinburg Municipal Airport & City of Edinburg Property
- D. AI-59927 EEOC Charge No. 451-2017-00801; Agnete Antons v. County of Hidalgo
- E. AI-59932 Claim of Estate of Gabriel Miranda, Jr., deceased
- F. AI-59954 Claim of AT&T
- G. AI-59956 Claim of Texas Department of Public Safety
- H. AI-59958 Claim of Juan Carlos Garcia
- I. AI-59960 Claim of Severino Roque
- J. AI-59994 Claim of AT&T

25.

OR

A. Requesting exemption from competitive bidding requirements under the Texas Local Government Code, Section 262.024(A) (4) "a Professional Service" for the "provision of legal services/representation in connection with litigation."

B. Requesting engagement with the firm of Preston Hennichson for the "Provision of Legal Services/Representation in connection with Litigation" and authority to submit letter of engagement (subject to compliance with HB1295) *26E*

26.

Open Session:

nlr **(A)**
nlr **(B)**
nlr **(C)**

Real Estate Acquisition and appropriation for same

Pending and/or potential litigation

AI-59999 Pending/potential litigation - Edinburg Municipal Airport & City of Edinburg Property