



**Hidalgo County
Planning
Department**

T.J. Arredondo, CFM
Director of Planning

Main Office

1304 S. 25th Street
Edinburg, Texas 78542
Phone (956) 318-2840
Fax (956) 318-2844

Engineering Projects Office

902 N. Doolittle Road
Edinburg, Texas 78542
Phone (956) 292-7080
Fax (956) 292-7089

Precinct No. 1 Substation

1902 Joe Stephens Ave.
Weslaco, Texas 78596
Phone (956) 968-4734
Fax (956) 973-7850

Precinct No. 3 Substation

2401 N. Moorefield Road
Mission, Texas 78572
Phone (956) 205-7045
Fax (956) 205-7049

PIPELINE AND UTILITY PERMIT APPLICATION PACKET

THE STATE OF TEXAS

COUNTY OF HIDALGO

PRECINCT 1

**APPLICATION AND AGREEMENT FOR PIPELINE OR
UTILITY PERMIT**

Date: 4/11/19

North Alamo Water Supply Corporation (hereinafter referred to as "Applicant") does hereby make application to the Hidalgo County through the Hidalgo County Planning Department (hereinafter referred to as "HCPD") to construct, maintain and repair pipelines or utilities across the easements, right-of-ways, property or property interest as described below.

Information required:

1. Name, Address and Phone number of Applicant:

North Alamo Water Supply Corporation Angie Hinojosa

420 S. Doolittle Rd. Edinburg, Tx 78542 956-383-1618

2. Name, Address and Phone number of company or agency owning Pipeline or Utility (please indicate if same as Applicant):

SAME

3. Name, Address and Phone number of operator of Pipeline or Utility (please indicate if same as Applicant):

SAME

4. Name, Address and Phone number of contractor to install Pipeline or Utility:

SAME



**Hidalgo County
Planning
Department**

T.J. Arredondo, CFM
Director of Planning

Main Office

1304 S. 25th Street
Edinburg, Texas 78542
Phone (956) 318-2840
Fax (956) 318-2844

Engineering Projects Office

902 N. Doolittle Road
Edinburg, Texas 78542
Phone (956) 292-7080
Fax (956) 292-7089

Precinct No. 1 Substation

1902 Joe Stephens Ave.
Weslaco, Texas 78596
Phone (956) 968-4734
Fax (956) 973-7850

Precinct No. 3 Substation

2401 N. Moorefield Road
Mission, Texas 78572
Phone (956) 205-7045
Fax (956) 205-7049

PIPELINE AND UTILITY PERMIT APPLICATION PACKET

5. Is this a common carrier pipeline or utility? If yes, please submit the Applicant's Texas Railroad Commission Form "T-4" or similar form designating the facility:

N/A

6. Does Applicant have the Power of Eminent Domain?

N/A

7. Will the product be carried for hire or by the owner of the goods?

NAWSC

8. Name and Legal description of property owner requesting utility services if applicable:

Abelardo Tapia Jr. La Quinta Estates No. 2 Lot 30

9. Type of utility work within county road right-of-way:

Bore Crossing Line Extension
Along R.O.W. Other _____

10. Where is the origin of the line?

Existing 6" waterline Southside of Mile 11N

11. Where is the destination of the line?

Northside of Mile 11N



**Hidalgo County
Planning
Department**

T.J. Arredondo, CFM
Director of Planning

Main Office

1304 S. 25th Street
Edinburg, Texas 78542
Phone (956) 318-2840
Fax (956) 318-2844

Engineering Projects Office

902 N. Doolittle Road
Edinburg, Texas 78542
Phone (956) 292-7080
Fax (956) 292-7089

Precinct No. 1 Substation

1902 Joe Stephens Ave.
Weslaco, Texas 78596
Phone (956) 968-4734
Fax (956) 973-7850

Precinct No. 3 Substation

2401 N. Moorefield Road
Mission, Texas 78572
Phone (956) 205-7045
Fax (956) 205-7049

PIPELINE AND UTILITY PERMIT APPLICATION PACKET

12. Utility Crossing Coordinate X: 3780277.70 Y: 1319690.59
(NAD 83 Texas South FIPS 4205 feet)
13. Number and size of lines:
One 3/4" water meter service with 2" PVC casing
14. Pressure (each line):
35 PSI
15. Content (each line):
Potable Water
16. Estimated date of installation of Pipeline or Utility:
As soon permit approved



Hidalgo County Planning Department

T.J. Arredondo, CFM
Director of Planning

Main Office

1304 S. 25th Street
Edinburg, Texas 78542
Phone (956) 318-2840
Fax (956) 318-2844

Engineering Projects Office

902 N. Doolittle Road
Edinburg, Texas 78542
Phone (956) 292-7080
Fax (956) 292-7089

Precinct No. 1 Substation

1902 Joe Stephens Ave.
Weslaco, Texas 78596
Phone (956) 968-4734
Fax (956) 973-7850

Precinct No. 3 Substation

2401 N. Moorefield Road
Mission, Texas 78572
Phone (956) 205-7045
Fax (956) 205-7049

PIPELINE AND UTILITY PERMIT APPLICATION PACKET

If requested permit is granted by HCPD, Applicant, in consideration thereof, agrees and binds itself as follows:

1. All pipelines or utilities herein will be horizontally placed within the right-of-way as determined by HCPD and at a minimum depth of five (5) feet below natural ground. Depth, horizontal, and vertical location shall be confirmed by HCPD Inspectors.
2. Location map, profile, and plans concerning the proposed pipeline or utility crossing will furnished with this application.
3. HCPD will be notified in writing ten days prior to the beginning date of construction under this permit.
4. Applicant will bear the entire expense of all future relocations of any pipelines or utilities should such relocation, at the sole discretion of the Hidalgo County Commissioners Court, be necessary for improvements, alteration, or maintenance of the Hidalgo County's easement or property of interest.
5. Applicant will notify the HCPD at least 48 hours prior to covering work and or completion of its work and removal of its equipment from the job site to permit HCPD to make an inspection.
6. Upon notification by the HCPD, the Applicant will promptly repair or rectify any deficiency or condition caused by the Applicant's operations or installations under this permit. Applicant will leave easement in as near the same condition or better, in the HCPD's sole judgment, as it existed prior to the commencement of the operations under this permit.
7. Hidalgo County shall not be liable or responsible for, and shall be saved and held harmless by Applicant, and further shall be indemnified by Applicant, from and against any and all suits, actions, losses, damages, claims, or liability of any character, type, or description, including all expenses of litigation, court costs, attorney's fees, and engineering fees for injury or death to any person, or injury to any property, received or sustained by any person or persons or property, arising out of, or occasioned by, directly or indirectly, the performance of Applicant under this agreement, including claims and damages arising in part from the negligence of the Hidalgo County.



Hidalgo County Planning Department

T.J. Arredondo, CFM
Director of Planning

Main Office

1304 S. 25th Street
Edinburg, Texas 78542
Phone (956) 318-2840
Fax (956) 318-2844

Engineering Projects Office

902 N. Doolittle Road
Edinburg, Texas 78542
Phone (956) 292-7080
Fax (956) 292-7089

Precinct No. 1 Substation

1902 Joe Stephens Ave.
Weslaco, Texas 78596
Phone (956) 968-4734
Fax (956) 973-7850

Precinct No. 3 Substation

2401 N. Moorefield Road
Mission, Texas 78572
Phone (956) 205-7045
Fax (956) 205-7049

PIPELINE AND UTILITY PERMIT APPLICATION PACKET

It is the expressed intent of the parties to this agreement that the indemnity provided for in this section is extended by Applicant to indemnify and protect Hidalgo County from the consequences of Hidalgo County's own negligence, whether that negligence is the sole or contributory cause of the resultant injury death, or damage.

Applicant further agrees to defend, at its own expense, with attorneys acceptable to Hidalgo County and on behalf of the Hidalgo County, and in the name of Hidalgo County, any claim or litigation brought against the Hidalgo County in connection with any such injury, death or damage.

Before construction is begun on such pipeline or utility crossings, Applicant will furnish to the HCPD a certificate of insurance (or other security approved by the HCPD) payable to Hidalgo County and protecting Hidalgo County (as an additional named insured) against any claims for personal injuries or damages to property resulting from the operations of Applicant, its agents, servants, employees, and contractors under this permit. Insurance is to be supplied in accordance with the attached Schedule A.

8. Hidalgo County makes no warranties, expressed or implied, in the granting of this permit; nor does Hidalgo County purport to grant any property interest or exclusive privileges whatsoever by granting such permit. It is specifically understood that Hidalgo County is not the agent for, nor does it act for, the fee owners or any persons or entities having any right, or title to possession of the land upon which the Hidalgo County's easement or other property interest is located. Furthermore, in granting this permit Hidalgo County makes no representation or warranty that it has any property interest, including, but not limited to, an easement or right of way, in the land

upon which Applicant constructs, maintains, repairs, or modifies the pipelines or utilities, made the subject of this application, nor does Hidalgo County make any representation or warranty as to the validity, quality or extent of such property interest, if any. Applicant acknowledges its understanding that Hidalgo County in granting this permit, does not convey or grant to Applicant any rights, title or interest for which is has no legal authority to grant or convey.

9. Applicant binds itself to comply with all federal, state, and local laws or regulations and will obtain all necessary permits from all local and federal agencies required by law before installation or construction is begun.



Hidalgo County Planning Department

T.J. Arredondo, CFM
Director of Planning

Main Office

1304 S. 25th Street
Edinburg, Texas 78542
Phone (956) 318-2840
Fax (956) 318-2844

Engineering Projects Office

902 N. Doolittle Road
Edinburg, Texas 78542
Phone (956) 292-7080
Fax (956) 292-7089

Precinct No. 1 Substation

1902 Joe Stephens Ave.
Weslaco, Texas 78596
Phone (956) 968-4734
Fax (956) 973-7850

Precinct No. 3 Substation

2401 N. Moorefield Road
Mission, Texas 78572
Phone (956) 205-7045
Fax (956) 205-7049

PIPELINE AND UTILITY PERMIT APPLICATION PACKET

10. Applicant will install its pipelines and utilities in a manner and location as shown in the plans and specifications filed with HCPD in support of this application for permit. Hidalgo County Planning Department's representative may at any time make such inspection as such engineer or other representation may deem necessary to assure that the construction of the pipeline or utilities is in accordance with the plans and specifications submitted, and said engineer or representative shall have the right to temporarily suspend Applicant's work if necessary, while such inspection is being made. Should Applicant not install the pipelines or utilities in accordance with the terms and conditions of this permit, Applicant agrees that the Hidalgo County shall have the right to require, at Applicant's expense, the removal of the pipelines and utilities and its replacement in conformance to said plans and specifications and conditions of this permit. Hidalgo County may revoke this permit and suspend all work hereunder if it is determined by Hidalgo County that the pipelines or utilities are not being installed in accordance with such plans and specifications and conditions of this permit. The suspension or revocation of this permit shall not be a basis for a claim for damages against Hidalgo County.

11. Except in emergency situations where it is necessary to protect life and property, Applicant will not make any change, modification, or alteration in or to the pipelines or utilities without first securing a new or amended permit from Hidalgo County prior to the making of any such change. Applicant will maintain the pipelines or utilities hereby authorized in good and safe condition, and in accordance with plans, specifications, and this permit.

12. Applicant agrees to pay HCPD a permit fee to cover administrative costs in the amount of **\$500.00**, plus a reimbursement to HCPD for any necessary engineering fees which may be incurred for the study and processing of the Application. This fee will permit a single pipeline or utility to be within County right-of-way. Applicant further agrees to pay an additional fee of **\$500.00** for each additional line included in permit application at the same location; however, more than one location may be included in a single application.

Requests to lay additional line or lines, not included in an initial permit application, must be made by separate application, with new permit fees paid accordingly and support data provided.



Hidalgo County Planning Department

T.J. Arredondo, CFM
Director of Planning

Main Office

1304 S. 25th Street
Edinburg, Texas 78542
Phone (956) 318-2840
Fax (956) 318-2844

Engineering Projects Office

902 N. Doolittle Road
Edinburg, Texas 78542
Phone (956) 292-7080
Fax (956) 292-7089

Precinct No. 1 Substation

1902 Joe Stephens Ave.
Weslaco, Texas 78596
Phone (956) 968-4734
Fax (956) 973-7850

Precinct No. 3 Substation

2401 N. Moorefield Road
Mission, Texas 78572
Phone (956) 205-7045
Fax (956) 205-7049

PIPELINE AND UTILITY PERMIT APPLICATION PACKET

Permit fees may be waived where Applicant is a state, county, municipality, or a special political subdivision.

13. The Applicant is allowed one hundred twenty days (120) from the granting of the permit to start construction of the pipelines or utilities crossings. Once started, the Applicant is allowed ninety (90) days to complete all work under such permit. All construction must be completed within two hundred ten (210) days from the date of issuance of permit. Upon application, extension of the time periods set forth in this paragraph may be granted by the Hidalgo County Commissioners Court. Such applications for extension must be received by HCPD at least thirty days before the expiration of the two hundred ten (210) days period. A new permit fee, in accordance with Paragraph 12 hereof, will be charged for each extension granted.

Construction of any pipeline or utility crossing will not begin until written approval has been given by HCPD.

14. All provisions of the Pipeline and Utility Permit Administration Policy of Hidalgo County, if any, and all amendments thereto, are hereby incorporated herein as part of the terms and conditions of this permit for all purposes.

15. Applicant warrants and represents that it has secured from all fee owners of the involved property an easement or other property rights to construct, repair or modify the pipeline or utility in the manner set forth herein.

16. This Pipeline and Utility Permit if granted by Hidalgo County is subject to any and all other requirements, specifications and conditions listed in Exhibit A attached hereto.

17. Hidalgo County requires all coordinates of all utility crossings. Horizontal datum to be in NAD 83 State Plane Texas South 4205 feet and vertical datum in NAVD 88 Geoid 12a.



**Hidalgo County
Planning
Department**

T.J. Arredondo, CFM
Director of Planning

Main Office

1304 S. 25th Street
Edinburg, Texas 78542
Phone (956) 318-2840
Fax (956) 318-2844

Engineering Projects Office

902 N. Doolittle Road
Edinburg, Texas 78542
Phone (956) 292-7080
Fax (956) 292-7089

Precinct No. 1 Substation

1902 Joe Stephens Ave.
Weslaco, Texas 78596
Phone (956) 968-4734
Fax (956) 973-7850

Precinct No. 3 Substation

2401 N. Moorefield Road
Mission, Texas 78572
Phone (956) 205-7045
Fax (956) 205-7049

PIPELINE AND UTILITY PERMIT APPLICATION PACKET

18. This permit constitutes the entire agreement between the parties with regard to the subject matter hereof, and all prior agreements, representations, and negotiations between the parties regarding the subject matter are hereby superseded. This permit shall not be altered or amended except by an agreement in writing executed by the parties hereto.

19. Applicant warrants and represents that its undersigned representative has full authority to bind Applicant to the terms and conditions of the foregoing Application and Agreement for Pipeline or Utility Permit.

DATED this _____ 11th _____ day of _____ April _____, 20 19 _____.

Angelica Hinojosa

(Name of Applicant – Printed or Typed)

By: Angelica Hinojosa
Signature

Title: New Account Supervisor

STATE OF TEXAS
COUNTY OF HIDALGO

SUBSCRIBED AND SWORN TO before me the Applicant,
Angelica Hinojosa, on this 11th day of April, 20 19,
to which witness my hand and seal of office.

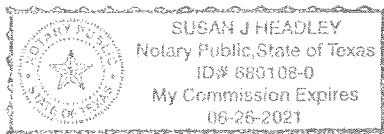

Susan J. Headley
Notary Public for the State of Texas

My Commission Expires: 6/26/2021



**Hidalgo County
Planning
Department**

T.J. Arredondo, CFM
Director of Planning

Main Office

1304 S. 25th Street
Edinburg, Texas 78542
Phone (956) 318-2840
Fax (956) 318-2844

Engineering Projects Office

902 N. Doolittle Road
Edinburg, Texas 78542
Phone (956) 292-7080
Fax (956) 292-7089

Precinct No. 1 Substation

1902 Joe Stephens Ave.
Weslaco, Texas 78596
Phone (956) 968-4734
Fax (956) 973-7850

Precinct No. 3 Substation

2401 N. Moorefield Road
Mission, Texas 78572
Phone (956) 205-7045
Fax (956) 205-7049

PIPELINE AND UTILITY PERMIT APPLICATION PACKET

**APPROVAL OF APPLICATION BY
HIDALGO COUNTY PLANNING DEPARTMENT**

Came on for consideration this _____ day of _____,
20____. The above and foregoing Application for Pipeline and Utility
Permit, and after consideration of the same by the Hidalgo County
Commissioners Court, said Application and Agreement for Pipeline or
Utility Permit is hereby APPROVED.

HIDALGO COUNTY:

Richard F. Cortez, County Judge



**Hidalgo County
Planning
Department**

T.J. Arredondo, CFM
Director of Planning

Main Office

1304 S. 25th Street
Edinburg, Texas 78542
Phone (956) 318-2840
Fax (956) 318-2844

Engineering Projects Office

902 N. Doolittle Road
Edinburg, Texas 78542
Phone (956) 292-7080
Fax (956) 292-7089

Precinct No. 1 Substation

1902 Joe Stephens Ave.
Weslaco, Texas 78596
Phone (956) 968-4734
Fax (956) 973-7850

Precinct No. 3 Substation

2401 N. Moorefield Road
Mission, Texas 78572
Phone (956) 205-7045
Fax (956) 205-7049

PIPELINE AND UTILITY PERMIT APPLICATION PACKET

EXHIBIT A

(Please insert description of project location and supporting documents for proposed utility work)



CERTIFICATE OF LIABILITY INSURANCE

DATE (MM/DD/YYYY)
3/11/2019

THIS CERTIFICATE IS ISSUED AS A MATTER OF INFORMATION ONLY AND CONFERS NO RIGHTS UPON THE CERTIFICATE HOLDER. THIS CERTIFICATE DOES NOT AFFIRMATIVELY OR NEGATIVELY AMEND, EXTEND OR ALTER THE COVERAGE AFFORDED BY THE POLICIES BELOW. THIS CERTIFICATE OF INSURANCE DOES NOT CONSTITUTE A CONTRACT BETWEEN THE ISSUING INSURER(S), AUTHORIZED REPRESENTATIVE OR PRODUCER, AND THE CERTIFICATE HOLDER.

IMPORTANT: If the certificate holder is an ADDITIONAL INSURED, the policy(ies) must have ADDITIONAL INSURED provisions or be endorsed. If SUBROGATION IS WAIVED, subject to the terms and conditions of the policy, certain policies may require an endorsement. A statement on this certificate does not confer rights to the certificate holder in lieu of such endorsement(s).

PRODUCER Higginbotham Insurance Agency, Inc. 1400 N McColl Rd Ste 105 McAllen TX 78501	CONTACT NAME: Judith Gomez	
	PHONE (A/C, No, Ext): 956-668-3510	FAX (A/C, No): 956-687-1286
E-MAIL ADDRESS: jgomez@higginbotham.net		
INSURER(S) AFFORDING COVERAGE		NAIC #
INSURER A: Cumis Insurance Society, Inc.		12831
INSURER B: Texas Mutual Insurance Company		22945
INSURER C: Cumis Insurance Society, Inc.		10847
INSURER D: RSUI Indemnity Company		22314
INSURER E: Hartford Fire Insurance Company		19682
INSURER F:		

COVERAGES	CERTIFICATE NUMBER: 1055284799	REVISION NUMBER:
------------------	---------------------------------------	-------------------------

THIS IS TO CERTIFY THAT THE POLICIES OF INSURANCE LISTED BELOW HAVE BEEN ISSUED TO THE INSURED NAMED ABOVE FOR THE POLICY PERIOD INDICATED. NOTWITHSTANDING ANY REQUIREMENT, TERM OR CONDITION OF ANY CONTRACT OR OTHER DOCUMENT WITH RESPECT TO WHICH THIS CERTIFICATE MAY BE ISSUED OR MAY PERTAIN, THE INSURANCE AFFORDED BY THE POLICIES DESCRIBED HEREIN IS SUBJECT TO ALL THE TERMS, EXCLUSIONS AND CONDITIONS OF SUCH POLICIES. LIMITS SHOWN MAY HAVE BEEN REDUCED BY PAID CLAIMS.

INSR LTR	TYPE OF INSURANCE	ADDL INSD	SUBR WVD	POLICY NUMBER	POLICY EFF (MM/DD/YYYY)	POLICY EXP (MM/DD/YYYY)	LIMITS
A	<input checked="" type="checkbox"/> COMMERCIAL GENERAL LIABILITY <input type="checkbox"/> CLAIMS-MADE <input checked="" type="checkbox"/> OCCUR GEN'L AGGREGATE LIMIT APPLIES PER: <input checked="" type="checkbox"/> POLICY <input type="checkbox"/> PRO-JECT <input type="checkbox"/> LOC OTHER:			306792	1/21/2019	1/21/2020	EACH OCCURRENCE \$ 1,000,000 DAMAGE TO RENTED PREMISES (Ea occurrence) \$ 100,000 MED EXP (Any one person) \$ 15,000 PERSONAL & ADV INJURY \$ 1,000,000 GENERAL AGGREGATE \$ 3,000,000 PRODUCTS - COMP/OP AGG \$ 3,000,000 \$
C	<input checked="" type="checkbox"/> AUTOMOBILE LIABILITY <input checked="" type="checkbox"/> ANY AUTO <input type="checkbox"/> OWNED AUTOS ONLY <input type="checkbox"/> SCHEDULED AUTOS <input type="checkbox"/> HIRED AUTOS ONLY <input type="checkbox"/> NON-OWNED AUTOS ONLY			306791	1/21/2019	1/21/2020	COMBINED SINGLE LIMIT (Ea accident) \$ 1,000,000 BODILY INJURY (Per person) \$ BODILY INJURY (Per accident) \$ PROPERTY DAMAGE (Per accident) \$ \$
C D	<input checked="" type="checkbox"/> UMBRELLA LIAB <input checked="" type="checkbox"/> OCCUR <input type="checkbox"/> EXCESS LIAB <input type="checkbox"/> CLAIMS-MADE DED <input checked="" type="checkbox"/> RETENTION \$ 10,000			306792 NHA246497	1/21/2019 1/21/2019	1/21/2020 1/21/2020	EACH OCCURRENCE \$ 5,000,000 AGGREGATE \$ 5,000,000 Occ/Aggregate \$10M \$ 10,000,000
B	<input type="checkbox"/> WORKERS COMPENSATION AND EMPLOYERS' LIABILITY <input type="checkbox"/> ANY PROPRIETOR/PARTNER/EXECUTIVE OFFICER/MEMBER EXCLUDED? (Mandatory in NH) If yes, describe under DESCRIPTION OF OPERATIONS below		N/A	0001132545	6/23/2018	6/23/2019	<input checked="" type="checkbox"/> PER STATUTE <input type="checkbox"/> OTH-ER E.L. EACH ACCIDENT \$ 1,000,000 E.L. DISEASE - EA EMPLOYEE \$ 1,000,000 E.L. DISEASE - POLICY LIMIT \$ 1,000,000
E	Crime Coverage			65FA022892119	1/21/2019	1/21/2020	Employee Theft Deductible 2,000,000 5,000

DESCRIPTION OF OPERATIONS / LOCATIONS / VEHICLES (ACORD 101, Additional Remarks Schedule, may be attached if more space is required)

--	--

CERTIFICATE HOLDER Hidalgo County Planning Department 1304 S. 25th St. Edinburg TX 78542	CANCELLATION SHOULD ANY OF THE ABOVE DESCRIBED POLICIES BE CANCELLED BEFORE THE EXPIRATION DATE THEREOF, NOTICE WILL BE DELIVERED IN ACCORDANCE WITH THE POLICY PROVISIONS. AUTHORIZED REPRESENTATIVE 
--	--

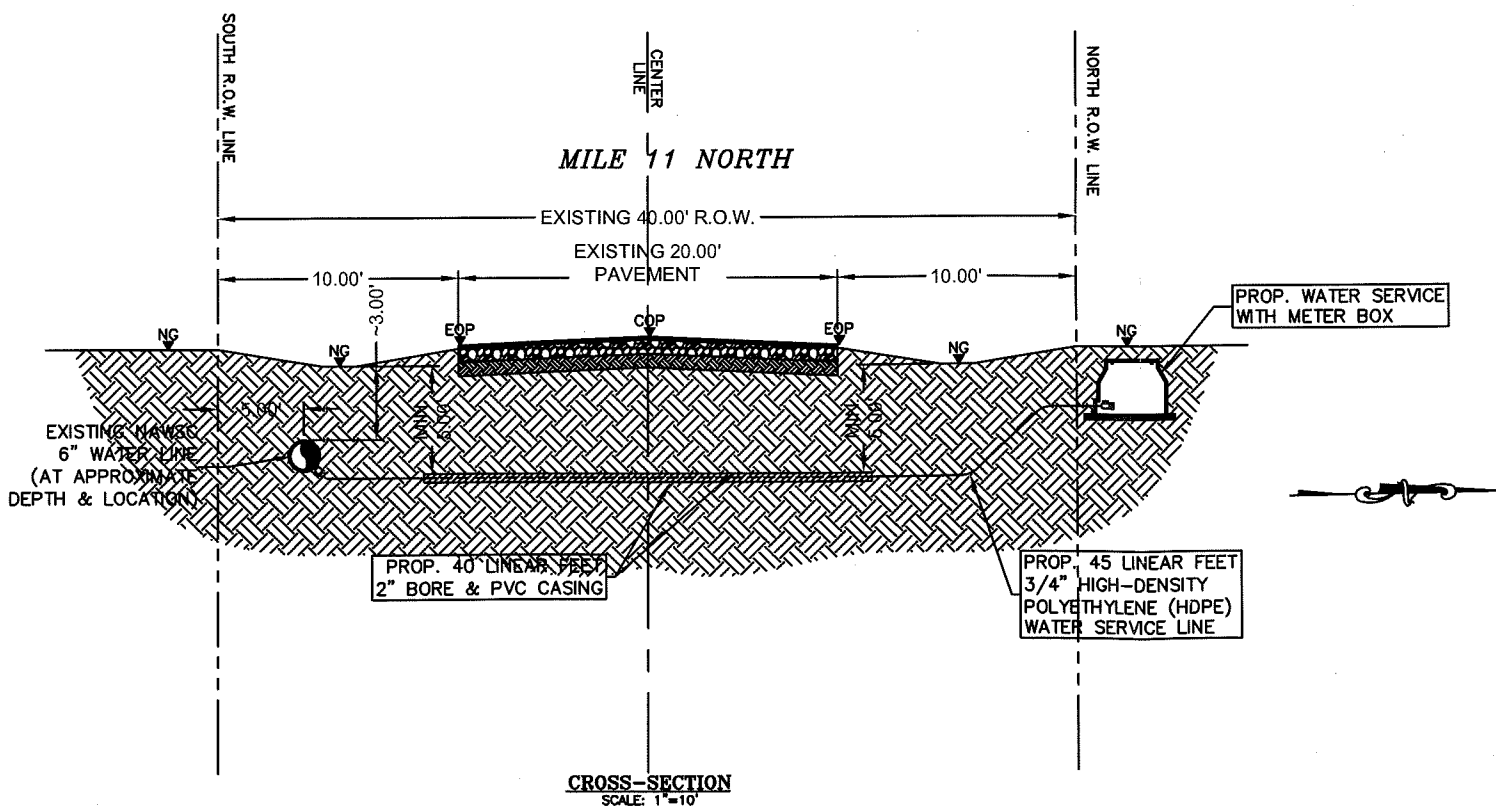
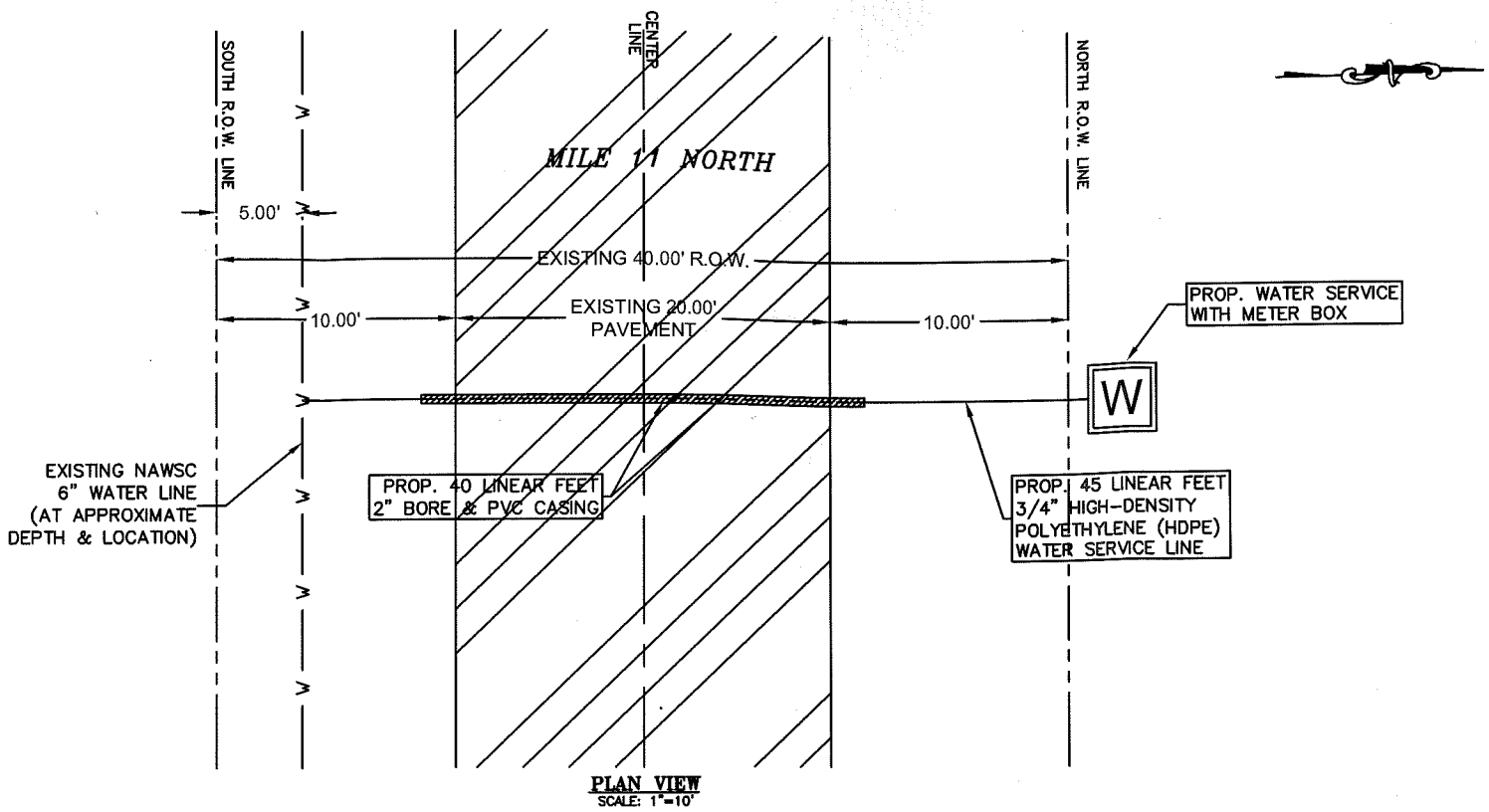

FROM CENTER OF MILE 11 N. & FM 88
 GO EAST 1,016' ON N.S./ S.S. BORE NEW
 SERVICE. 2" PVC CASING 3/4" METER
 SERVICE TO A 6" WATER LINE WILL BORE
 MILE 11 N. SOUTH TO NORTH 4' DEEP
 WESLACO, TEXAS

MILE 11 NORTH

FM 88

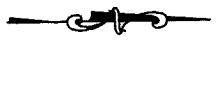

6" WL

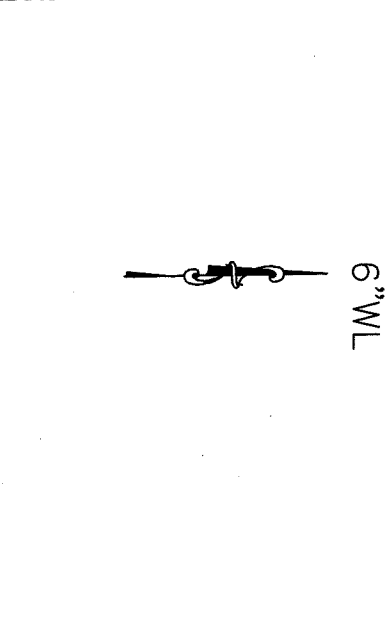

- GENERAL NOTES:**
1. THE LOCATION OF UNDERGROUND UTILITIES SHOWN ON THESE PLANS ARE BASED ON OBSERVATION OF ABOVE GROUND STRUCTURES, LINES SPOTTED BY THE OWNER, AND UTILITY SPOTTING. ACTUAL LOCATION OF THESE UTILITIES MAY VARY, AND ADDITIONAL BURIED UTILITIES MAY BE ENCOUNTERED UPON EXCAVATION.
 2. BEFORE BEGINNING CONSTRUCTION, THE CONTRACTOR SHALL CALL FOR UTILITY SPOTTING BY THE APPROPRIATE AGENCY AND VERIFY THE LOCATION OF THESE UTILITIES TO HIS SATISFACTION. (1-800-DIG-TESS)
 3. ANY DAMAGE CAUSED TO EXISTING STRUCTURES AND/OR UTILITIES BY THE CONTRACTOR SHALL BE THE CONTRACTOR'S RESPONSIBILITY TO CORRECT AT HIS EXPENSE.
 4. ANY DAMAGE TO PROPERTY, OUTSIDE THE CONSTRUCTION ZONE, CAUSED BY THE CONTRACTOR, SHALL BE THE CONTRACTOR'S RESPONSIBILITY TO CORRECT AT HIS EXPENSE.

LEGEND	
NG	NATURAL GROUND
EOP	EDGE OF PAVEMENT
COP	CENTER OF PAVEMENT
PROP.	PROPOSE
EXIST.	EXISTING
ROW	RIGHT-OF-WAY
MIN.	MINIMUM

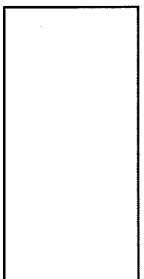

4/10/19

WATER SERVICE LINE
 2-INCH BORE
 MILE 11 NORTH
 WESLACO, TEXAS

NORTH ALAMO
 WATER SUPPLY CORP.

ABELARDO TAPIA JR.

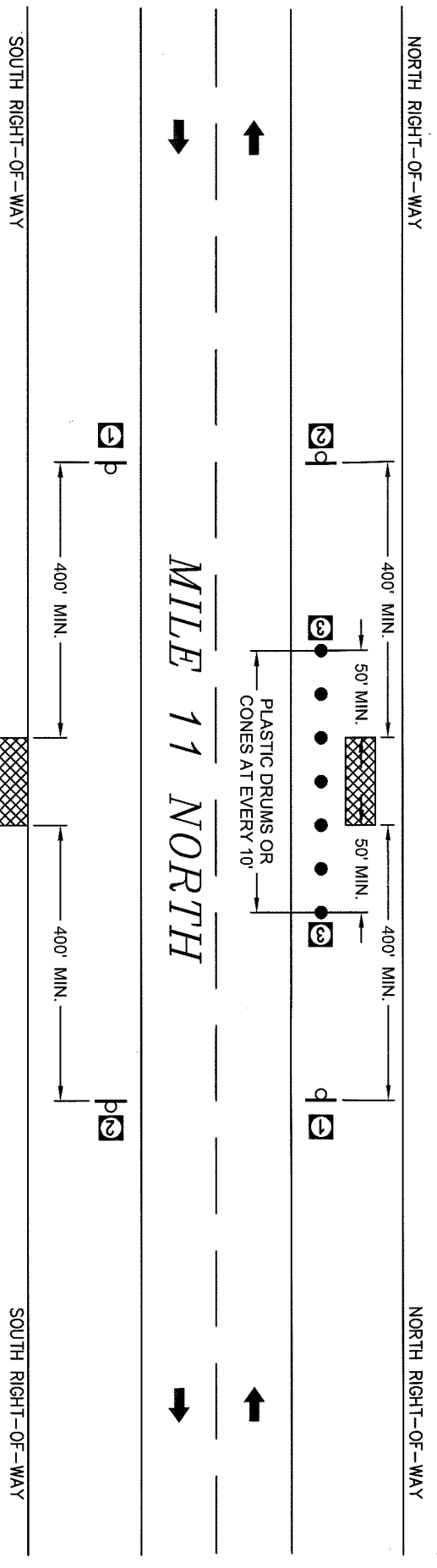

GENERAL NOTES:
 1. ALL SIGNS, PLASTIC DRUMS, AND BARRICADES SHALL BE IN ACCORDANCE WITH THE TEXAS MANUAL ON UNIFORM TRAFFIC CONTROL DEVICES (TMUTCD) 2014.
 2. REFER TO TxDOT BARRICADE AND CONSTRUCTION CHANNELIZING DEVICES STANDARD PLANS AND TO TRAFFIC CONTROL STANDARD PLANS FOR ADDITIONAL REQUIREMENTS AND SPECIFICATIONS.

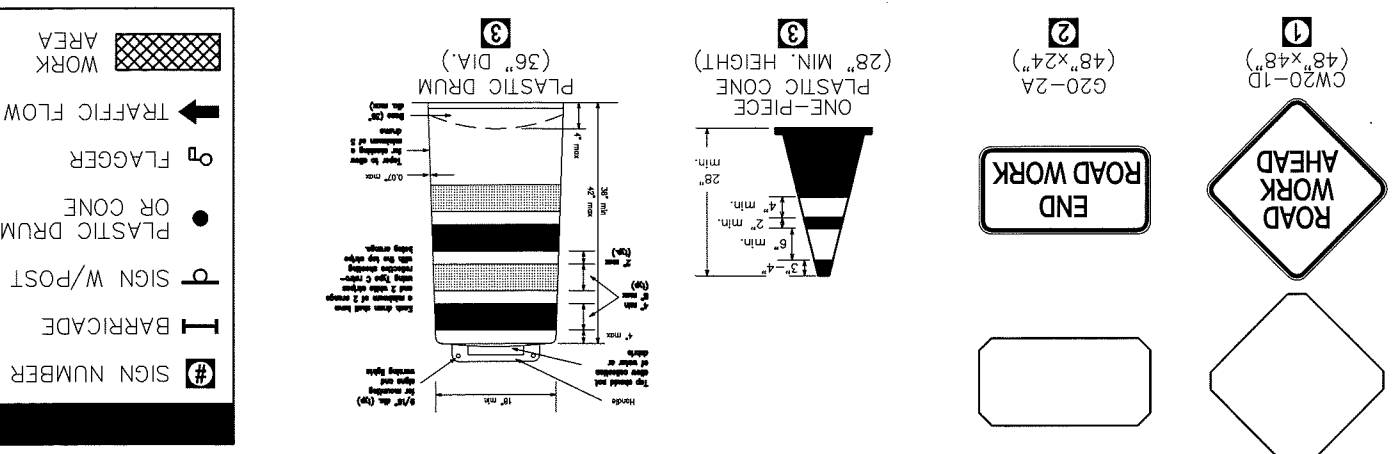

TRAFFIC CONTROL PLAN (TCP)

WATER SERVICE LINE
 2-INCH BORE
 MILE 11 NORTH
 WESLACO, TEXAS

NORTH ALAMO
 WATER SUPPLY CORP.

4/10/19