



# HIDALGO COUNTY PLANNING DEPARTMENT

T.J. Arredondo  
Director of Planning

2818 S. BUSINESS HWY 281  
EDINBURG TEXAS 78539  
Tel. 956-318-2840 Fax. 956-318-2844

## HIDALGO COUNTY COMMISSIONERS COURT MEETING

DATE: **5-02-2023**

PROPOSED **EL COYOTE SUBDIVISION**, PRECINCT No. **3**.

ENGINEER: **M2 ENGINEERING, PLLC**, DEVELOPER: **JAVIER ESQUEDA**

PRELIMINARY APPROVAL     FINAL APPROVAL     FINAL APPROVAL WITH FINANCIAL GUARANTEE     WITH VARIANCE

NUMBER OF LOTS:     \*SINGLE FAMILY     \*MULTI-FAMILY    3  COMMERCIAL     INSTITUTIONAL

ESTIMATED NUMBER OF STREETLIGHTS: **N/A**

FILLING STATIONS: **1**

LOCATION DESCRIPTION: **EAST SIDE OF LA HOMA ROAD (FM 364) APPROXIMATELY ¼ OF A MILE SOUTH OF MILE 4 NORTH ROAD.**

SUBDIVISION LIES WITHIN THE:  ETJ OF **MISSION**

DRAINAGE REPORT WAS APPROVED BY HCDD#1: ON **12-21-2022** PROPERTY LIES WITHIN FLOOD ZONE: **"X" & "A"** AS PER FEMA.

DRAINAGE DESIGN: **DRAINAGE WILL BE PROVIDED BY ONSITE DETENTION, DETENTION WILL ULTIMATELY OUTFALL TO AN EXISTING STORM SEWER SYSTEM ALONG LA HOMA ROAD.**

ROAD R.O.W. DEDICATION: **20.00 FEET ONTO LA HOMA ROAD ( FM 364)**

H.C.R.O.W. PRELIMINARY APPROVAL DATE: **12-22-2022** BY, **VICTOR GALLARDO, PCT. 3** R.O.W. AGENT

H.C.H.D. PRELIMINARY APPROVAL DATE: **7-01-2022** BY, ENVIRONMENTAL HEALTH DIVISION MANAGER

SEWER SYSTEM:  SANITARY SEWER , BY **CITY OF MISSION** LINE SIZE: **8"** LOCATION: **LA HOMA ROAD**

WATER SERVICE PROVIDER: **SWSC** LINE SIZE: **8"** LOCATION: **LA HOMA ROAD.**

H.C.E.O.C. PRELIMINARY APPROVAL DATE: **12-13-2023** BY **MARTIN RAMIREZ** ENVIRONMENTAL COMPLIANCE COORDINATOR

**SMALL CONSTRUCTION**

The applicant has submitted the required small construction site notice as per Part II, Section E Of the TPDES General Permit for Construction Activities (TXR150000) along with a copy of the Erosion Control Plan for the proposed project.

PRELIMINARY APPROVAL FROM THE  
HIDALGO COUNTY COMMISSIONERS COURT ON:

STAFF RECOMMENDS:  **Preliminary Approval** subject to comments and future recommendations by planning, other departments and the approval of the City of **MISSION**.

**Final Approval** subject to recommendations other departments

**This subdivision plat has been reviewed and complies with the Hidalgo County Subdivision Rules,**

**\* Texas Water Development Board Model Subdivision Rules and The Texas Local Government Code.**



LOCATION MAP SCALE 1" = 2000'

LOCATION OF SUBDIVISION WITH RESPECT TO THE EXTRATERRITORIAL JURISDICTION OF A MUNICIPALITY:

EL COYOTE SUBDIVISION IS LOCATED IN WEST HIDALGO COUNTY, ON THE EAST SIDE OF LA HOMA ROAD (F.M. 364) AND APPROXIMATELY 1000.00 FEET SOUTH OF W MILE 4 ROAD INTERSECTION. THE ONLY NEARBY MUNICIPALITY IS THE CITY OF MISSION ACCORDING TO THE MAP IN THE OFFICE OF SECRETARY OF THE CITY OF MISSION (POPULATION 83,563). EL COYOTE SUBDIVISION LIES APPROXIMATELY 1.00 MILES OUTSIDE OF THE CITY LIMITS AND IT'S WITHIN THE CITY OF MISSION 5-MILE JURISDICTION (ETJ) UNDER LOCAL GOVERNMENT COD 212.001 AND LIES IN PRECINCT No. 3.

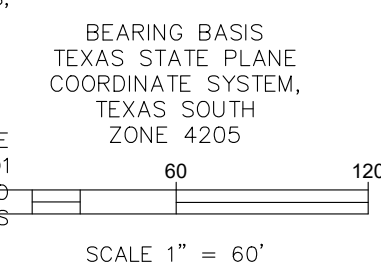

LEGEND: 1/2" IRON ROD FOUND "IRF", 1/2" IRON ROD SET WITH PINK CAP "IRS", RECORD BEARING & DISTANCE, CALCULATED POINT "CP", SWSC - SHARYLAND WATER SUPPLY CORPORATION

METES AND BOUNDS

BEING A 12.166 ACRE TRACT OUT OF LOT 36 AND LOT 37, NEW CALEDONIA UNIT NO. 3, RECORDED IN VOLUME 6, PAGES 47, MAP RECORDS, HIDALGO COUNTY, TEXAS, SAID 12.166 ACRES BEING MORE PARTICULARLY DESCRIBED BY METES AND BOUNDS AS FOLLOWS: BEGINNING AT A CALCULATED POINT, THE SOUTHWEST CORNER OF THE SAID LOT 36, FOR THE SOUTHWEST CORNER OF THE HEREIN DESCRIBED TRACT AND THE POINT OF BEGINNING; THENCE, N08°57'35"E, ALONG THE WEST LINE OF THE SAID LOTS 36 AND 37, SAME BEING THE CENTERLINE OF F.M. 364 (LA HOMA ROAD), A DISTANCE OF 592.64 FEET TO A CALCULATED POINT ON THE SAID LOT 37, SAME BEING A POINT ON THE CENTERLINE OF F.M. 364 (LA HOMA ROAD), FOR THE NORTHWEST CORNER OF THE HEREIN DESCRIBED TRACT; THENCE, S81°02'14"W, ALONG THE SAID LOT 37, SAME BEING THE SOUTH LINE OF A CALLED 4.00 ACRE TRACT CONVEYED TO PROPIEDAD PRIVADA LLC, RECORDED IN DOCUMENT No. 2955842, OFFICIAL PUBLIC RECORDS HIDALGO COUNTY, TEXAS, PASSING AT A DISTANCE OF 60.00 FEET A 1/2 INCH IRON ROD WITH A PINK CAP STAMPED "C.L.S. RPLS #6388" SET, CONTINUING FOR A TOTAL DISTANCE OF 699.91 FEET TO A 1/2 INCH IRON ROD FOUND, THE SOUTHEAST CORNER OF THE SAID 4.00 ACRE TRACT, FOR THE NORTHWEST CORNER OF THE HEREIN DESCRIBED TRACT; THENCE, S24°17'52"E, ALONG THE WEST LINE OF A CALLED 3.62 ACRE TRACT CONVEYED TO JUAN S. SR. AND JUAN S. JR. HERNANDEZ, RECORDED IN DOCUMENT No. 1225060, OFFICIAL PUBLIC RECORDS HIDALGO COUNTY, TEXAS, A DISTANCE OF 708.74 FEET TO A 1/2 INCH IRON ROD WITH PLASTIC CAP STAMPED "RDS" FOUND THE SOUTHWEST CORNER OF THE SAID 3.62 ACRE TRACT, SAME BEING THE NORTHEAST CORNER OF A CALLED 8.28 ACRE TRACT CONVEYED TO WAYNE EVEAN SOJACK, RECORDED IN DOCUMENT No. 2671368, OFFICIAL PUBLIC RECORDS HIDALGO COUNTY, TEXAS, FOR THE SOUTHEAST CORNER OF THE HEREIN DESCRIBED TRACT; THENCE, N81°02'14"W, ALONG THE NORTH LINE OF THE SAID 8.28 ACRE TRACT, SAME BEING THE NORTH LINE OF A CALLED 5.00 ACRE TRACT CONVEYED TO MIGUEL LOSOYA JR., RECORDED IN DOCUMENT No. 1002692, OFFICIAL PUBLIC RECORDS HIDALGO COUNTY, TEXAS, PASSING AT A DISTANCE OF 1028.58 FEET A 1/2 INCH IRON ROAD WITH A PINK CAP STAMPED "C.L.S. RPLS #6388" SET, CONTINUING FOR A TOTAL DISTANCE OF 1088.58 FEET TO THE POINT OF BEGINNING, AND CONTAINING 12.166 ACRES, MORE OR LESS.

GENERAL NOTES:

- 1. FLOOD ZONE STATEMENT: FLOOD ZONE DESIGNATION: ZONE "X" (NO SHADE)
ZONE "X" AREAS (NO SHADE), AREAS DETERMINED TO BE OUTSIDE 500-YEAR FLOODPLAIN ACCORDING TO COMMUNITY-PANEL NO. 480334 0290 D, REVISED JUNE 6, 2000.
FLOOD ZONE STATEMENT: (APPROXIMATELY SHOWN BASES ON FEMA MAP) FLOOD ZONE DESIGNATION: ZONE "A"
ZONE "A" AREAS, NO BASE FLOOD ELEVATION DETERMINED ACCORDING TO COMMUNITY-PANEL NO. 480334-0400C, REVISED NOVEMBER 16, 1982.
LOMAR-F NOTE: THE ORIGINAL ZONE 'A' MODIFIED BY CONDITIONAL LETTER OF MAP REVISION BASED ON FILL CASE # \_\_\_\_\_ TO ZONE \_\_\_\_\_.
2. SETBACKS: FRONT: 50.00 FEET. REAR: 15.00 FEET OR EASEMENT WHICHEVER IS GREATER. SIDE: 6.00 FEET OR EASEMENT WHICHEVER IS GREATER.
3. GENERAL NOTE FOR COMMERCIAL LOTS: LOTS 1, 2, AND 3 SHALL BE FOR COMMERCIAL USE ONLY. THERE SHALL BE NO OTHER USE OTHER THAN COMMERCIAL. LOTS 1, 2, AND 3 ARE FOR NONRESIDENTIAL USE. THIS MUST BE STIPULATED ON ALL DEEDS, AND CONTRACT FOR DEEDS. A BUFFER FENCE IS REQUIRED TO BE INSTALLED BY DEVELOPER ALONG ALL ADJUTING RESIDENTIAL LOTS. APPLICATIONS FOR CONSTRUCTION APPROVED BY THE PLANNING DEPARTMENT, OFFICE OF ENVIRONMENTAL COMPLIANCE, HEALTH DEPARTMENT AND FIRE MARSHALL ARE REQUIRED PRIOR TO OCCUPYING THE LOT.
4. MINIMUM FINISHED FLOOR ELEVATION SHALL BE 24" ABOVE THE CENTER LINE OF STREET OR 24" ABOVE NATURAL GROUND AND NO LOWER THAN THE HIGHEST FINISH FLOOR IN THE SURROUNDING NEIGHBORING PROPERTY, WHICHEVER IS GREATER. ELEVATION CERTIFICATE WILL BE REQUIRED.
5. THE FOLLOWING BENCHMARKS ARE IDENTIFIED ON THE FACE OF THE PLAT AND ON THE ATTACHED ENGINEERING PLANS.
6. IN ACCORDANCE WITH THE HIDALGO COUNTY DRAINAGE DISTRICT NO. 1 AND HIDALGO COUNTY REQUIREMENTS, THIS DEVELOPMENT WILL BE REQUIRED TO DETAIN A TOTAL OF 130,973 CUBIC- FEET OR 3.01 ACRE-FEET OF STORM WATER RUNOFF. RUNOFF WILL BE DETAINED IN DETENTION GREEN AREAS IN THE LOT.
7. DRAINAGE EASEMENT NOTE: NO FILL OR PERMANENT STRUCTURES SHALL BE ALLOWED WITHIN ANY DRAINAGE SWALE EASEMENT. EACH DRAINAGE SWALE EASEMENT SHALL BE KEPT CLEAR OF FENCES, BUILDINGS, PLANTINGS, AND OTHER OBSTRUCTIONS THAT WOULD INTERFERE WITH THE OPERATION OF THE DRAINAGE SWALE EASEMENT. THE LOT OWNER SHALL BE RESPONSIBLE FOR THE MAINTENANCE OF THE SWALE.
8. DRAINAGE NOTE: IN ACCORDANCE WITH THE HIDALGO COUNTY DRAINAGE DISTRICT No.1 AND HIDALGO COUNTY DRAINAGE REQUIREMENTS, THIS INDUSTRIAL DEVELOPMENT IS REQUIRED TO DETAIN A TOTAL OF 130,973 C.F. (3.01 AC.-FT) OF STORM WATER RUNOFF. AT THE TIME OF PERMITTING, EACH LOT OWNER SHALL BE REQUIRED TO PROVIDE THE REQUIRED DETENTION STORAGE VOLUME AND RELEASE AT A MAXIMUM FLOW RATE AS DESCRIBED BELOW.
LOT 1: 43,688 C.F. (1.00 AC.-FT.) @ 2.43 CFS (EXIST 10-YR O)
LOT 2: 43,420 C.F. (1.00 AC.-FT.) @ 1.75 CFS (EXIST 10-YR O)
LOT 3: 51,937 C.F. (1.19 AC.-FT.) @ 1.75 CFS (EXIST 10-YR O)
AT THE PERMITTING STAGE, IF IT IS DETERMINED THAT THE DETENTION REQUIREMENTS ARE GREATER THAN THAT OF THE PLAT ENGINEER'S HYDRAULIC ANALYSIS, THE DEVELOPER SHALL BE RESPONSIBLE FOR DETAINING AND ACCOMMODATING MORE THAN THE DETAINED VOLUME SHOWN ON THIS PLAT.
9. NO STRUCTURE SHALL BE PERMITTED OVER ANY EASEMENT. EASEMENTS SHALL BE KEPT CLEAR OF BUILDINGS, SHEDS, SHRUBS TREES, AND OTHER PLANTINGS (EXCEPT LOW, LESS THAN 18 INCHES MATURE HEIGHT, GROUND COVER, GRASS, OR FLOWERS) AND OTHER OBSTRUCTIONS THAT WOULD INTERFERE WITH THE OPERATIONS AND MAINTENANCE OF THE EASEMENT.
10. EACH PURCHASE CONTRACT MADE BETWEEN A SUBDIVIDER AND PURCHASER OF A LOT IN THIS SUBDIVISION SHALL CONTAIN A STATEMENT DESCRIBING HOW AND WHEN WATER, SEWER, ELECTRICITY, AND GAS SERVICES WILL BE MADE AVAILABLE TO THE SUBDIVISION.
11. ALL PUBLIC UTILITIES EASEMENTS DEDICATED BY THIS PLAT SHALL BE A MINIMUM WIDTH OF 15.00 FEET AS PER THE HIDALGO COUNTY MODEL SUBDIVISION RULES. BY SIGNING THIS PLAT, DEVELOPER AND ENGINEER CERTIFY THAT ALL OTHER EASEMENTS SHOWN COMPLY WITH THE SIZE REQUIRED BY EACH UTILITY PROVIDER OCCUPYING AN EASEMENT.
12. THERE ARE NO WATER WELLS WITHIN 150 FEET FROM THE BOUNDARIES ON THIS SUBDIVISION
13. ANY ADDITION TO EXISTING COMMERCIAL STRUCTURE OR NEW PROPOSED DWELLING ON THE LOT MUST COMPLY WITH ALL SETBACK RESTRICTIONS RECORDED ON THIS PLAT.
14. ALL LOT SHALL HAVE A POST DEVELOPMENT FINISHED GRADE FROM THE CENTER OF THE LOT TO THE CURB AND/OR ROADSIDE DITCH AT A 0.25 % SLOPE TO ACCOMPLISH POSITIVE DRAINAGE. THIS IS IN ACCORDANCE WITH HIDALGO COUNTY SUBDIVISION RULES APPENDIX 3.1.4.1.
15. A 6 FOOT OPAQUE BUFFER REQUIRED FROM ADJACENT/BETWEEN MULTI-FAMILY RESIDENTIAL AND COMMERCIAL, OR INDUSTRIAL ZONES/USES. PERIMETER BUFFERS MUST BE BUILT AT TIME OF SUBDIVISION IMPROVEMENTS.
16. AN ENGINEERED DRAINAGE DETENTION PLAN, APPROVED BY THE ENGINEERING DEPARTMENT, WILL BE REQUIRED PRIOR TO ISSUANCE OF BUILDING PERMITS.
17. THE PURCHASER OF EACH LOT SHALL BE RESPONSIBLE TO INSTALL DRIVEWAY CULVERT REINFORCED CONCRETE PIPE OF NO LESS THAN 15 INCHES IN DIAMETER AND 24 FEET IN LENGTH.
18. ALL SHARYLAND WATER SUPPLY CORPORATION EASEMENT ARE EXCLUSIVE. NO OTHER USE OF EASEMENT IS PERMITTED WITHOUT THE EXPRESS WRITTEN APPROVAL OF SHARYLAND WATER SUPPLY CORPORATION.
19. PROPOSED DETENTION AREAS SHALL BE MAINTAINED BY INDIVIDUAL LOT OWNERS.
20. CLEARANCE FOR WATER METERS: AS PER LOCAL GOVERNMENT CODE REQUIREMENTS, SANITARY SEWER MUST BE CONNECTED TO A RESIDENCE PRIOR TO THE COUNTY PROCESSING A FINAL CLEARANCE FOR WATER METER. A SEWER TAP INSPECTION SHALL BE PROVIDED FROM THE ENTITY SERVICE PROVIDER PRIOR TO RECEIVING A CLEARANCE FOR WATER METER(S).
21. THE PURCHASER OF EACH LOT SHALL BE RESPONSIBLE TO INSTALL DRIVEWAY CULVERT REINFORCED CONCRETE PIPE OF NO LESS THAN 15 INCHES IN DIAMETER AND 24 FEET IN LENGTH.

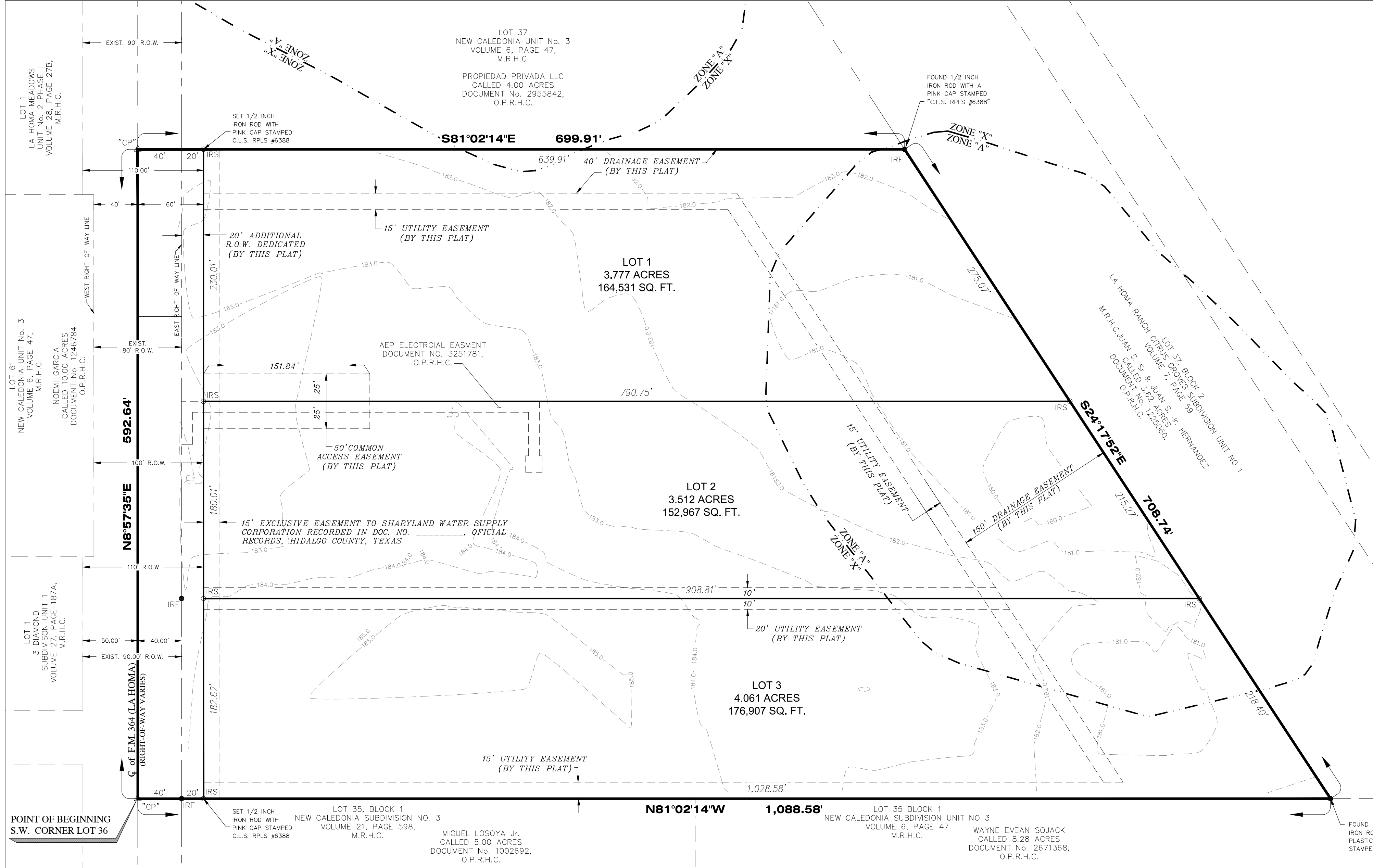

HIDALGO COUNTY DRAINAGE DISTRICT NO. 1 CERTIFICATE

HIDALGO COUNTY DRAINAGE DISTRICT NO. 1 HEREBY CERTIFIES THAT THE DRAINAGE PLANS FOR THIS SUBDIVISION COMPLY WITH THE MINIMUM STANDARDS OF THE DISTRICT ADOPTED UNDER TEXAS WATER CODE NO. 49.211(C) THE DISTRICT HAS NOT REVIEWED AND DOES NOT CERTIFY THAT THE DRAINAGE STRUCTURES DESCRIBED ARE APPROPRIATE FOR THE SPECIFIC SUBDIVISION, BASED ON GENERALLY ACCEPTED ENGINEERING CRITERIA. IT IS THE RESPONSIBILITY OF THE DEVELOPER OF THE SUBDIVISION AND ITS ENGINEER TO MAKE THESE DETERMINATIONS.

HIDALGO COUNTY DRAINAGE DISTRICT No. 1
RAUL E. SESIN, P.E., C.F.M. DATE
GENERAL MANAGER

HIDALGO COUNTY IRRIGATION DISTRICT No. 6

THIS PLAT IS HEREBY APPROVED BY THE HIDALGO COUNTY IRRIGATION DISTRICT No. 6 ON THIS DAY OF \_\_\_\_\_, 2022. NO IMPROVEMENTS OF ANY KIND (INCLUDING WITHOUT LIMITATION TREES, FENCES AND BUILDINGS) SHALL BE PLACED UPON HIDALGO COUNTY IRRIGATION DISTRICT No. 6 RIGHT OF WAYS OR EASEMENTS. APPROVAL OF THIS PLAT DOES NOT RELEASE ANY RIGHTS THAT THE DISTRICT MAY HAVE WHETHER SHOWN OR NOT.

ATTEST: BOARD OF DIRECTOR DATE:
STATE OF TEXAS COUNTY OF HIDALGO

INDEX OF SHEETS: EL COYOTE SUBDIVISION

SHEET 1: HEADING; INDEX; LOCATION AND ETJ MAP; PRINCIPAL CONTACTS; MAP; LOT, STREETS, AND EASEMENT LAYOUT; SURVEYOR'S CERTIFICATION; OWNERS' DEDICATION, CERTIFICATION, ATTESTATION; ENGINEERING CERTIFICATION; HIDALGO COUNTY IRRIGATION DISTRICT NO. 6 CERTIFICATION; COUNTY CLERK'S RECORDING CERTIFICATE; SHARYLAND WATER SUPPLY CORPORATION CERTIFICATE; LOT AREAS; PLAT NOTES AND RESTRICTIONS; DESCRIPTION (METES AND BOUNDS); HIDALGO COUNTY CERTIFICATE; HIDALGO DRAINAGE DISTRICT NO.1 CERTIFICATE; CITY APPROVAL CERTIFICATE;
SHEET 2: ENGINEERING REPORT, INCLUDING DESCRIPTION OF WATER AND SANITARY SEWER ENGINEER'S CERTIFICATION (ENGLISH AND SPANISH VERSION), WATER AND SANITARY LAYOUT; DETAILS;
SHEET 3: MAP OF TOPOGRAPHY AND DRAINAGE LAYOUT; STORM DRAINAGE CONSTRUCTION DETAILS; DRAINAGE REPORT INCLUDING DESCRIPTION OF DRAINAGE, ENGINEERING CERTIFICATION;

HIDALGO COUNTY JUDGE DATE
HIDALGO COUNTY CLERK DATE

STATE OF TEXAS COUNTY OF HIDALGO

I, THE UNDERSIGNED, EMIGDIO "MILO" SALINAS, P.E., A LICENSED PROFESSIONAL ENGINEER, IN THE STATE OF TEXAS, DO HEREBY CERTIFY THAT THE PROPER SURVEYING CONSIDERATION HAS BEEN GIVEN TO THIS PLAT, AND THAT IT IS A TRUE AND ACCURATE REPRESENTATION OF THE SUBDIVISION OF THE LANDS HEREON DESCRIBED.

EMIGDIO "MILO" SALINAS, P.E. DATE
LICENSED PROFESSIONAL ENGINEER No. 107703
FIRM REGISTERED No. F-19545

STATE OF TEXAS COUNTY OF HIDALGO
I, THE UNDERSIGNED, MANUEL CARRIZALES, A REGISTERED PROFESSIONAL LAND SURVEYOR, IN THE STATE OF TEXAS, DO HEREBY CERTIFY THAT PROPER SURVEYING CONSIDERATION HAS BEEN GIVEN TO THIS PLAT, AND THAT IT IS A TRUE AND ACCURATE REPRESENTATION OF THE SUBDIVISION OF THE LANDS HEREON DESCRIBED.

MANUEL CARRIZALES, RPLS # 6388 DATE
TBPELS FIRM NO. 10194417
4807 GONDOLA AVENUE
EDINBURG, TEXAS 78542
512-470-1489
InIcod@gmail.com

SHARYLAND WATER SUPPLY CORPORATION

I, CARLOS LIMA, HEREBY CONDITIONALLY CERTIFY THAT POTABLE WATER SERVICE IS AVAILABLE FOR THE EL COYOTE SUBDIVISION LOCATED IN ALTON, HIDALGO COUNTY, TEXAS, SUBJECT TO THE SUBDIVISION'S POTABLE WATER SYSTEM MEETING THE APPROVAL OF THE DEVELOPER'S DESIGN ENGINEER, ALL APPLICABLE RULES AND REGULATIONS OF SHARYLAND WATER SUPPLY CORPORATION, AND LOCAL, STATE, AND FEDERAL AGENCIES.

DEVELOPER AND ITS DESIGN ENGINEER SHALL BEAR FULL RESPONSIBILITY TO ENSURE THAT THE ABOVE REFERENCED POTABLE WATER SYSTEM IS CONSTRUCTED WITHIN THE DESIGNATED SHARYLAND WATER SUPPLY CORPORATION EXCLUSIVE EASEMENT.

CARLOS LIMA - GENERAL MANAGER DATE
SHARYLAND WATER SUPPLY CORPORATION

STATE OF TEXAS COUNTY OF HIDALGO

I, THE UNDERSIGNED, EMIGDIO "MILO" SALINAS, P.E., A LICENSED PROFESSIONAL ENGINEER, IN THE STATE OF TEXAS, DO HEREBY CERTIFY THAT THE PROPER ENGINEERING CONSIDERATION HAS BEEN GIVEN TO THIS PLAT.

EMIGDIO "MILO" SALINAS, P.E. DATE
LICENSED PROFESSIONAL ENGINEER No. 107703
FIRM REGISTERED No. F-19545

STATE OF TEXAS COUNTY OF HIDALGO

I, THE UNDERSIGNED, MANUEL CARRIZALES, A REGISTERED PROFESSIONAL LAND SURVEYOR, IN THE STATE OF TEXAS, DO HEREBY CERTIFY THAT PROPER SURVEYING CONSIDERATION HAS BEEN GIVEN TO THIS PLAT, AND THAT IT IS A TRUE AND ACCURATE REPRESENTATION OF THE SUBDIVISION OF THE LANDS HEREON DESCRIBED.

MANUEL CARRIZALES, RPLS # 6388 DATE
TBPELS FIRM NO. 10194417
4807 GONDOLA AVENUE
EDINBURG, TEXAS 78542
512-470-1489
InIcod@gmail.com

STATE OF TEXAS COUNTY OF HIDALGO OWNER'S DEDICATION, CERTIFICATION, AND ATTESTATION

I, JAVIER ESQUEDA OWNER OF THE LAND SHOWN ON THIS PLAT AND DESIGNATED HEREIN AS EL COYOTE SUBDIVISION, HEREBY SUBDIVIDE THE LAND AS DEPICTED IN THIS SUBDIVISION PLAT AND DEDICATE TO PUBLIC USE THE STREETS, AND EASEMENTS SHOWN HEREIN.

- I CERTIFY THAT I HAVE COMPLIED WITH REQUIREMENTS OF TEXAS LOCAL GOVERNMENT CODE §232.032 AND THAT:
(A) THE WATER QUALITY AND CONNECTIONS TO THE LOTS MEET, OR WILL MEET THE MINIMUM STATE STANDARDS;
(B) SEWER CONNECTIONS TO THE LOTS MEET OR WILL MEET THE MINIMUM REQUIREMENTS OF STATE STANDARDS;
(C) ELECTRICAL CONNECTIONS PROVIDED TO THE LOTS MEET OR WILL MEET THE MINIMUM STATE STANDARDS, AND;
(D) GAS CONNECTION AS, IF AVAILABLE, PROVIDED TO THE LOTS MEET, OR WILL MEET THE MINIMUM STATE STANDARDS.
I ATTEST THAT THE MATTERS ASSERTED IN THIS PLAT ARE TRUE AND COMPLETE.

JAVIER ESQUEDA
201 W. MILE 3 ROAD
MISSION, TEXAS 78573

STATE OF TEXAS COUNTY OF HIDALGO

BEFORE ME, THE UNDERSIGNED AUTHORITY, ON THIS DAY PERSONALLY APPEARED JAVIER ESQUEDA KNOWN TO ME TO BE THE PERSON WHOSE NAME IS SUBSCRIBED TO THE FOREGOING INSTRUMENT, AND ACKNOWLEDGED TO ME THAT HE EXECUTED THE SAME FOR THE PURPOSES AND CONSIDERATIONS THEREIN STATED.

GIVEN UNDER MY HAND AND SEAL OF OFFICE THIS \_\_\_\_\_ DAY OF \_\_\_\_\_, 2022.

NOTARY PUBLIC, STATE OF TEXAS DATE
MY COMMISSION EXPIRES:

CITY OF MISSION

I, THE UNDERSIGNED MAYOR OF THE CITY OF MISSION DO HEREBY CERTIFY THAT THIS SUBDIVISION PLAT CONFORMS TO ALL REQUIREMENTS OF THE SUBDIVISION REGULATIONS OF THIS CITY WHEREIN MY APPROVAL IS REQUIRED.

MAYOR OF CITY OF MISSION DATE

CITY OF MISSION PLANNING & ZONING COMMISSION CERTIFICATE

I, THE UNDERSIGNED, CHAIRMAN OF THE PLANNING AND ZONING COMMISSION OF THE CITY OF MISSION, HEREBY CERTIFY THAT THIS SUBDIVISION PLAT CONFORMS TO ALL REQUIREMENTS OF THE SUBDIVISION REGULATIONS OF THIS CITY WHEREIN MY APPROVAL IS REQUIRED.

DATED THIS \_\_\_\_\_ DAY OF \_\_\_\_\_, 2022, A.D.

CHAIRMAN, PLANNING & ZONING COMMISSION DATE

EL COYOTE SUBDIVISION

BEING A 12.166 ACRE TRACT OUT OF LOT 36 AND LOT 37, NEW CALEDONIA UNIT NO. 3, RECORDED IN VOLUME 6, PAGES 47, MAP RECORDS, HIDALGO COUNTY, TEXAS



TBPELS FIRM REGISTRATION F-19545

1810 E. GRIFFIN PARKWAY
MISSION TX 78572
956-600-8628

Table with columns: OWNER, ENGINEER, SURVEYOR, ON, INSTRUMENT NUMBER, OF THE MAP RECORDS OF HIDALGO COUNTY, TEXAS, BY, NAME, DEPUTY, ADDRESS, CITY & ZIP, PHONE. Includes contact info for Javier Esqueda, Emigdio Salinas, and Manuel Carrizales.

**FINAL ENGINEERING REPORT FOR EL COYOTE SUBDIVISION:**  
BY EMIGDIO "MILO" SALINAS, P.E.

**WATER SUPPLY: DESCRIPTION AND COSTS.**

WATER SUPPLY:  
EL COYOTE SUBDIVISION HAS BEEN PROVIDED WITH POTABLE WATER BY THE SHARYLAND WATER SUPPLY CORPORATION ("S.W.S.C."). THE SUBDIVIDER AND S.W.S.C. SIGNED A CONTRACT BY WHICH, THE SUBDIVISION WILL RECEIVE SUFFICIENT WATER PROVISION FOR AT LEAST 30 YEARS AND S.W.S.C. HAS PROVIDED SUFFICIENT DOCUMENTATION TO ESTABLISH THE LONG TERM QUANTITY AND QUALITY OF THE AVAILABLE WATER SUPPLIES TO SERVE THE FULL DEVELOPMENT OF THIS SUBDIVISION.

S.W.S.C. HAS AN EXISTING 6" DIAMETER LINE RUNNING ALONG THE WEST SIDE OF LA HOMA ROAD.

THE WATER SYSTEM FOR EL COYOTE SUBDIVISION CONSIST OF TWO (2) 2" SINGLE SERVICE LINES GOING TO THE WATER BOXES OF LOTS 1 AND 2. LOT 3 HAS AN EXISTING SERVICE LINE AND THE 2" SINGLE SERVICE LINES, AND THE WATER METER BOXES HAVE BEEN INSTALLED AT A TOTAL COST OF \$XXX,XXX OR \$XXX,XX PER LOT. IN ADDITION THE SUBDIVIDER HAS PAID S.W.S.C. THE AMOUNT OF \$XXX,XXX WHICH COVERS THE \$XXX,XX PER LOT STATED IN THE 30 YR WATER SERVICE AGREEMENT WHICH SUM REPRESENTS THE TOTAL COST OF WATER METER, RIGHTS ACQUISITION FEES, AND ALL MEMBERSHIP OR OTHER FEES ASSOCIATED WITH CONNECTING THE INDIVIDUAL LOTS IN THE SUBDIVISION TO S.W.S.C. UPON REQUEST BY THE LOT OWNER, S.W.S.C. WILL PROMPTLY INSTALL AT NO CHARGE THE WATER METER FOR THAT LOT. THE ENTIRE WATER FACILITIES HAVE BEEN APPROVED AND ACCEPTED BY S.W.S.C. AND SAID DISTRIBUTION SYSTEM IS OPERABLE AS OF THE DATE OF THE RECORDING OF THE PLAT.

**SANITARY SEWAGE DESCRIPTION AND EXPENSES:**

EL COYOTE SUBDIVISION IS TREATED BY WASTEWATER SERVICE FROM CITY OF MISSION, THE SUBDIVIDER AND THE CITY OF MISSION HAVE ENTERED INTO A CONTRACT IN WHICH THE CITY OF MISSION HAS PROMISED TO TREAT THE SUFFICIENT WASTEWATER FOR AT LEAST 30 YEARS AND CITY OF MISSION HAS PROVIDED DOCUMENTATION TO SUFFICIENTLY ESTABLISH THE LONG TERM QUANTITY AND QUALITY OF THE AVAILABLE WASTEWATER SUPPLIES TO SERVE THE FULL DEVELOPMENT OF THIS SUBDIVISION.

THE CITY OF MISSION HAS AN EXISTING 8" SANITARY SEWER LINE RUNNING ALONG THE EAST SIDE OF LA HOMA ROAD.

THE WASTEWATER SYSTEM FOR EL COYOTE SUBDIVISION CONSIST OF ONE (1) 6" SERVICE LINE FOR LOT 2, THERE IS TWO (2) EXISTING SERVICE LINES SERVING LOTS 1 AND 3.

THE 6" SERVICE LINE HAVE BEEN INSTALLED, AT A TOTAL COST OF \$XXX,XXX OR \$XXX,XX PER LOT. IN ADDITION, THE SUBDIVIDER HAS PAID THE CITY OF MISSION THE SUM OF \$XXX,XXX WHICH COVERS THE \$XXX,XX PER LOT AS STATED IN THE 30 YEAR WASTE WATER SERVICE AGREEMENT WHICH SUMS REPRESENTS THE TOTAL COST OF THE SERVICES AND ACQUISITION FEES, AND ALL MEMBERSHIP OR OTHER FEES ASSOCIATED WITH CONNECTING THE INDIVIDUAL LOTS IN THE SUBDIVISION TO THE CITY OF MISSION. THE SUBDIVIDER HAS POSTED A LETTER OF CREDIT WITH THE FILING OF THIS PLAT WITH THE CITY OF MISSION IN THE AMOUNT OF \$XXX,XX TO COVER THE COST FOR THE REMAINING WASTEWATER DISTRIBUTION SYSTEM.

**ENGINEER CERTIFICATION**

BY MY SIGNATURE BELOW, I CERTIFY THAT THE WATER AND SEWAGE SERVICE FACILITIES DESCRIBED ABOVE ARE IN COMPLIANCE WITH THE MODEL RULES ADOPTED UNDER SECTION 16.343 WATER CODE. I CERTIFY THAT THE COST TO INSTALL WATER AND SEWAGE FACILITIES, DISCUSSED ABOVE, ARE AS FOLLOWS.

WATER FACILITIES - THESE FACILITIES FULLY CONSTRUCTED HAS COST A GRAND TOTAL OF \$XXX,XX WHICH EQUALS TO \$XXX,XX PER LOT.

SEWAGE FACILITIES - THESE FACILITIES FULLY CONSTRUCTED WILL COST A GRAND TOTAL OF \$XXX,XX PER LOT.

EMIGDIO "MILO" SALINAS, P.E.  
LICENSED PROFESSIONAL ENGINEER No. 107703  
FIRM REGISTERED No. F-19545

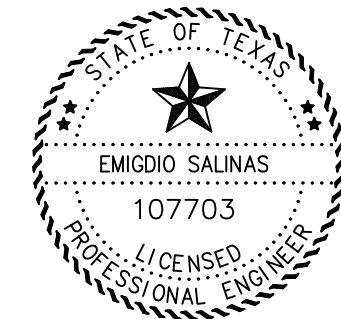

EL COYOTE SUBDIVISION:  
POR: EMIGDIO "MILO" SALINAS, P.E.

**PROVISIÓN DE AGUA: DESCRIPCIÓN, Y GASTOS.**

EL COYOTE SUBDIVISION HA SIDO PROVISITA DE AGUA POTABLE POR SHARYLAND WATER SUPPLY CORPORATION (LA COMPAÑIA DE AGUA SHARYLAND) ("S.W.S.C."). EL SUBDIVIDOR Y LA COMPAÑIA DE AGUA S.W.S.C. FIRMARON UN CONTRATO POR EL CUAL LA SUBDIVISION RECIBIRA PROVISIÓN DE AGUA SUFFICIENTE POR LOS PROXIMOS 30 ANOS Y LA COMPAÑIA DE AGUA, S.W.S.C. PRESENTO SUFFICIENTE DOCUMENTACION PARA ESTABLECER A LARGO PLAZO LA CANTIDAD Y CALIDAD DE AGUA ABASTECIDA PARA SERVIR EL FUTURO DESARROLLO DE LA SUBDIVISION.

S.W.S.C. TIENE UNA LINEA DE 6" DE DIAMETRO EXISTENTE, CORRIENDO POR EL LADO OESTE DE LA CALLE LA HOMA ROAD.

EL SISTEMA DE AGUA PARA EL COYOTE SUBDIVISION CONSISTE DE DOS (2) SERVICIOS DE AGUA SENCILLOS DE 2" DE DIAMETRO QUE VAN HACIA LOS MEDIDORES DE LOS LOTES 1 Y 2. LOTE 3 TIENE UNA LINEA DE SERVICIO EXISTENTE.

LAS LINEAS DE SERVICIOS DE AGUA, Y LAS CAJAS DE LOS MEDIDORES SE INSTALARON A UN COSTO TOTAL DE US \$XXX,XXX,XX DE LOS CUALES SE CUBRIO US \$XXX,XXX,XX POR LOTE. EL DUENO DE LA SUBDIVISION PAGO ADICIONALMENTE A S.W.S.C. LA CANTIDAD DE US \$XXX,XXX,XX US \$XXX,XXX,XX POR LOTE DE ACUERDO AL CONTRATO Y DOCUMENTO DE 30 ANOS DE SERVICIO DE AGUA POTABLE QUE CUBRE EL MEDIDOR DE AGUA, (INCLUYENDO COSTOS DE LA INSTALACION DE CADA MEDIDOR, TARIFAS DE CONEXION Y MEMBRESIAS). CUANDO EL DUENO DEL SOLAR SOLICITE UN MEDIDOR DE AGUA, LA COMPAÑIA S.W.S.C. INSTALARA EL MEDIDOR SIN COSTO ALGUANO AL DUENO. EL SISTEMA DE AGUA ESTA EN FUNCIONAMIENTO COMPLETO ANTES O EN LA FECHA, EN LA CUAL LA SUBDIVISION SEA REGISTRADA EN EL CONDADO DE HIDALGO.

**DRENAJE: DESCRIPCIÓN, GASTOS Y FECHA DE INICIO PARA FACILITAR EL DRENAJE PARA LA SUBDIVISION**

LA SUBDIVISION EL COYOTE SUBDIVISION RECIBIRA SU PROVISIÓN DE DRENAJE SANITARIO DE LA CIUDAD DE MISSION. EL DUENO DE LA SUBDIVISION Y LA CIUDAD DE MISSION HAN FIRMADO UN CONTRATO POR EL CUAL LA SUBDIVISION RECIBIRA SU PROVISIÓN DE DRENAJE SANITARIO POR LOS PROXIMOS 30 ANOS. LA CIUDAD DE MISSION HA PRESENTADO DOCUMENTACION PARA DEMOSTRAR A LARGO PLAZO LA CANTIDAD Y CALIDAD DE DRENAJE SANITARIO ACCESIBLE PARA SERVIR EL FUTURO DESARROLLO DE LA SUBDIVISION.

LA CIUDAD DE MISSION TIENE UNA LINEA EXISTENTE DE 8 PULGADAS DE DIAMETRO QUE CORRE POR EL LADO ESTE DE LA CARRETERA LA HOMA ROAD.

EL SISTEMA DE PROVISIÓN DE DRENAJE SANITARIO PARA LA SUBDIVISION EL COYOTE SUBDIVISION CONSISTE DE UN (1) SERVICIO DE 6 PULGADAS QUE HAN SIDO INSTALADAS, HA UN COSTO TOTAL DE \$XXX,XXX,XX OR \$XXX,XXX,XX POR LOTE. EL DUENO TAMBIEN LE HA PAGADO A LA CIUDAD DE MISSION UN COSTO TOTAL DE \$XXX,XXX,XX O \$XXX,XXX,XX POR LOTE. EL DUENO HA PUBLICADO UNA CARTA DE CREDITO CON LA PRESENTACION DE ESTE PLANO A LA CIUDAD DE MISSION EN LA CANTIDAD DE \$XXX,XXX,XX PARA CUBRIR EL COSTO DEL SISTEMA DE DISTRIBUCION DE DRENAJE SANITARIO.

**ENGINEER CERTIFICACION:**

CON MI FIRMA, CERTIFICO QUE LOS SERVICIOS Y SISTEMAS DE AGUA Y DE DRENAJE, DESCRITOS EN ESTE DOCUMENTO CUMPLEN CON LAS MODEL SUBDIVISION RULES (LAS REGLAS GOBERNANDO A LAS SUBDIVISIONES), ADOPTADAS EN LA SECCION 16.343 DEL TEXAS WATER CODE (CÓDIGO DE AGUA DE TEXAS). CERTIFICO QUE LOS GASTOS PARA INSTALAR LOS SISTEMAS DE AGUA Y DE DRENAJE SON:

AGUA: EL SISTEMA/SERVICIO DE AGUA HA SIDO INSTALADO Y COMPLETAMENTE CONSTRUIDO A UN COSTO TOTAL DE US \$XXX,XX O US \$XXX,XX POR LOTE.

DRENAJE: SE ESTIMA QUE EL DRENAJE COSTO EN TOTAL US \$XXX,XX O US \$XXX,XX POR LOTE.

EMIGDIO "MILO" SALINAS, P.E.  
LICENSED PROFESSIONAL ENGINEER No. 107703  
FIRM REGISTERED No. F-19545

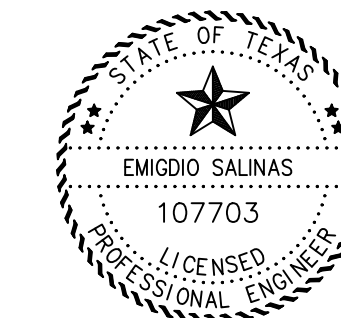

BY COMPLETING THE IMPROVEMENTS DESCRIBED ON THIS PLAT, SUBDIVIDER WILL COMPLY WITH MINIMUM STATE STANDARDS AND THAT (A) WATER QUALITY AND CONNECTIONS INCLUDING WATER METERS AND OR WATER WELLS FOR EACH LOT MEET SUCH STANDARDS AND (B) SEWER CONNECTIONS TO THE LOTS OR SEPTIC TANKS MEET OR WILL MEET SUCH STANDARDS AND WILL BE CONSTRUCTED IN ACCORDANCE WITH STATE AN COUNTY REGULATIONS.

I, JAVIER ESQUEDA SUBDIVIDER OF EL COYOTE SUBDIVISION HERE BY CERTIFY SEWER PERMITS HAVE BEEN PAID AND COPIES OF RECEIPTS ARE ON FILE WITH THE HIDALGO COUNTY HEALTH DEPARTMENT THAT ANY ADEQUATE DRINKING WATER SOURCE IS IMMEDIATELY AVAILABLE TO EACH LOT OF THE TYPE, QUALITY AND QUANTITY TO ENABLE EACH PERSON PURCHASING A LOT HAVE ADEQUATE WATER TO COMPLY WITH THE REGULATIONS AND LAWS OF THE STATE AS REQUIRED BY STATE AND COUNTY REGULATIONS.

JAVIER ESQUEDA  
201 W. MILE 3 ROAD  
MISSION, TEXAS 78572

GENERAL NOTES:  
1. ALL CONCRETE TO HAVE A MINIMUM OF 28 DAYS COMPRESSIVE STRENGTH OF 3,000 P.S.I.

CONSTRUCTION NOTES:  
A. WATER MAIN (SEE PLANS AND SPECIFICATIONS)  
B. TAPPING SLEEVE (SIZE AS REQUIRED)  
C. CONCRETE SUPPORT UNDER TAPPING SLEEVE AND BEHIND  
D. THURST BLDG. AS PER SPECIFICATIONS  
E. FLANGED AND HUB ENDS OF RING SEALS WITH 2" SQUARE WRENCH NUT GATE VALVE  
F. ANCHOR BOLDS  
G. PVC PIPE  
H. SIMPLEX COUPLING

STATE OF TEXAS  
COUNTY OF HIDALGO  
BEFORE ME, THE UNDERSIGNED AUTHORITY, ON THIS DAY PERSONALLY APPEARED JAVIER ESQUEDA KNOWN TO ME TO BE THE PERSON WHOSE NAME IS SUBSIBED TO THE FOREGOING INSTRUMENT, AND ACKNOWLEDGED TO ME THAT HE EXECUTED THE SAME FOR THE PURPOSES AND CONSIDERATIONS THEREIN STATED.

GIVEN UNDER MY HAND AND SEAL OF OFFICE THIS \_\_\_\_\_ DAY OF \_\_\_\_\_ 20\_\_\_\_

NOTARY PUBLIC, STATE OF TEXAS  
MY COMMISSION EXPIRES: \_\_\_\_\_

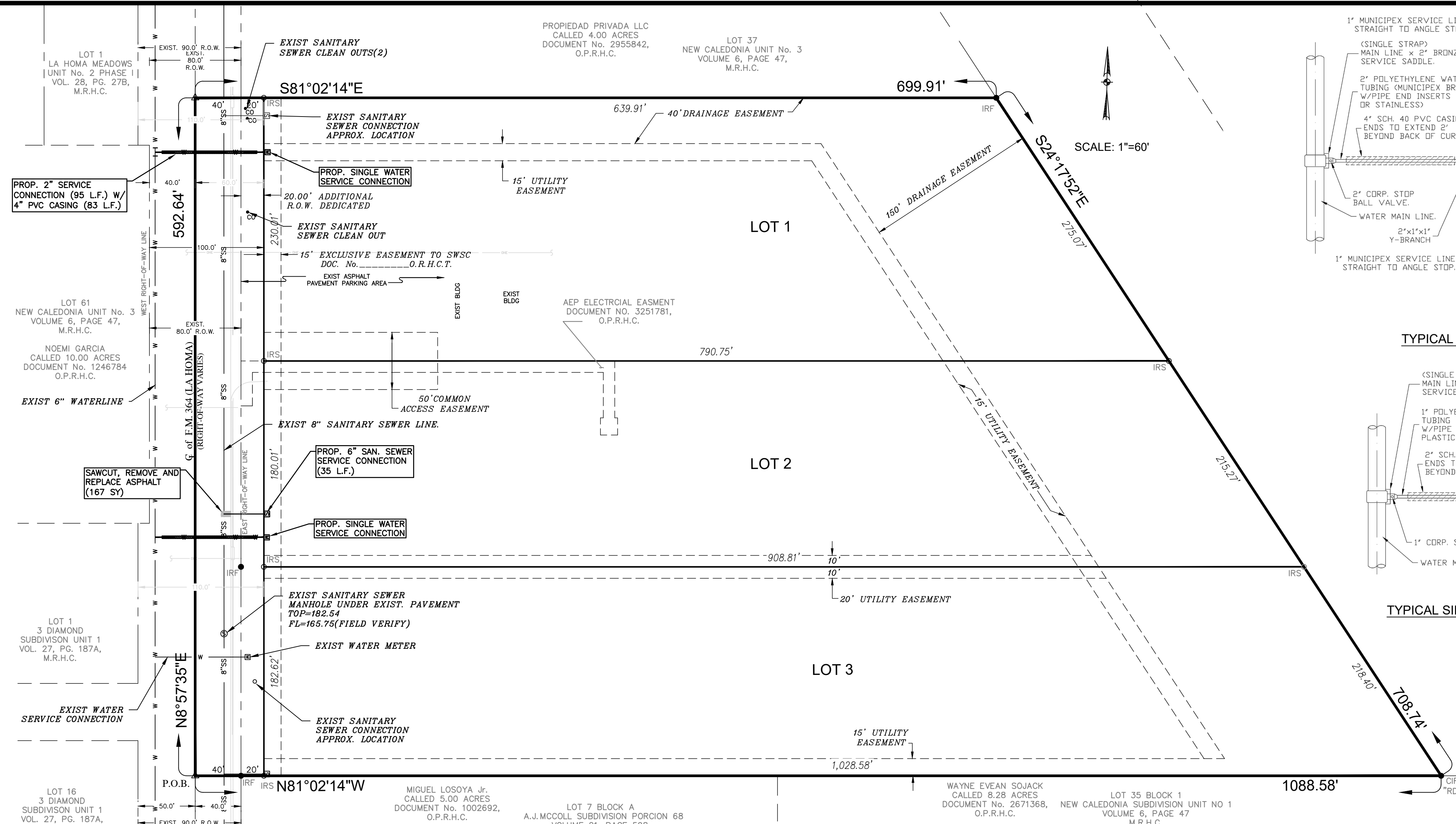

**COST ESTIMATE:**

WATER DISTRIBUTION: \$ XXX,XXX,XX  
SANITARY SEWER COLLECTION: \$ XXX,XXX,XX

**ESTIMACION DE COSTOS:**

DRENAJE PLUMAL: \$ XXX,XXX,XX  
SERVICIO DE AGUA POTABLE: \$ XXX,XXX,XX  
SERVICIO DE DRENAJE SANITARIO: \$ XXX,XXX,XX

**LEGEND**

— W — W — EXISTING WATER LINE  
— SS — SS — EXISTING SANITARY SEWER

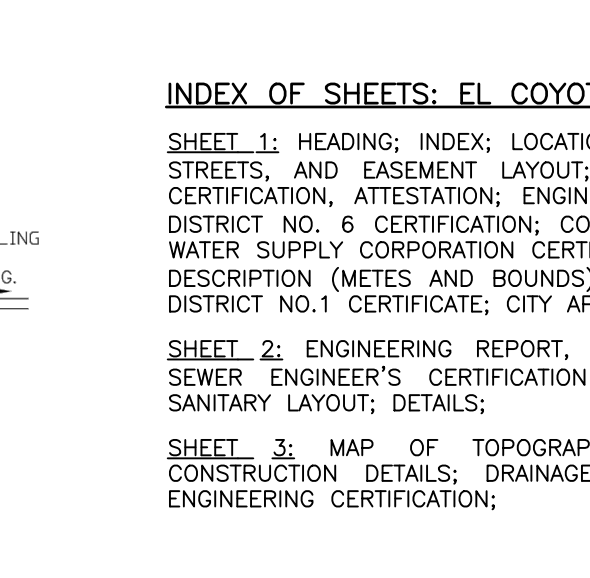
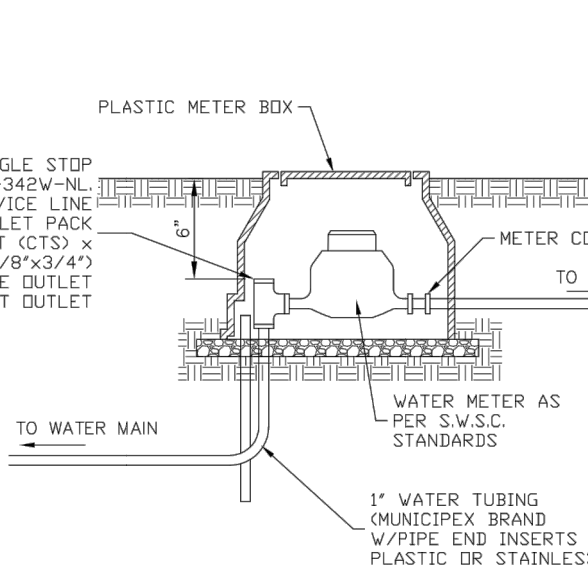
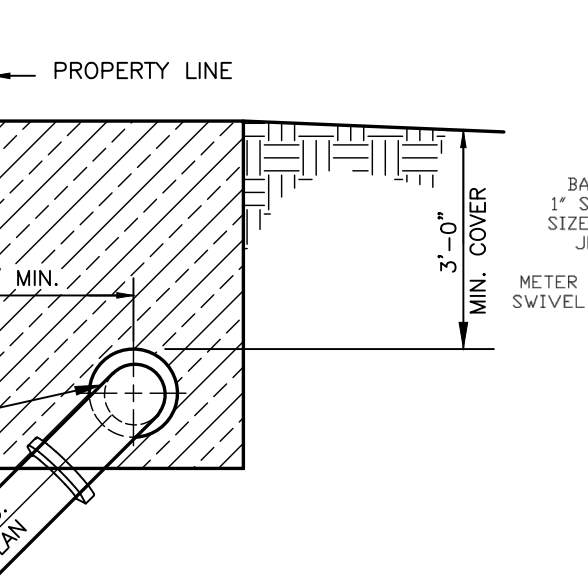
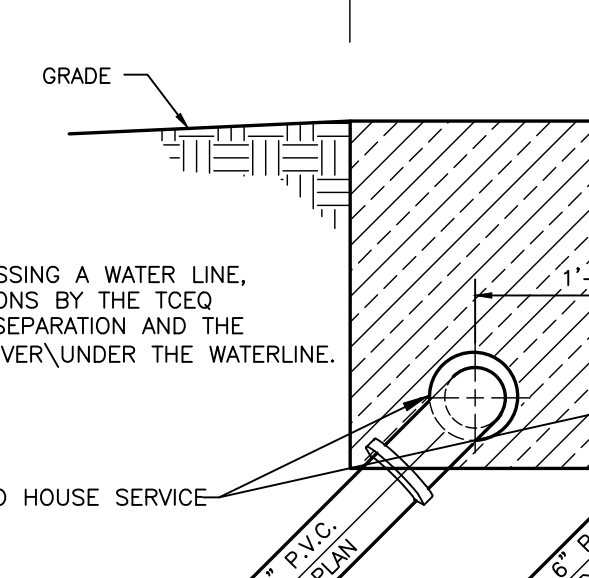
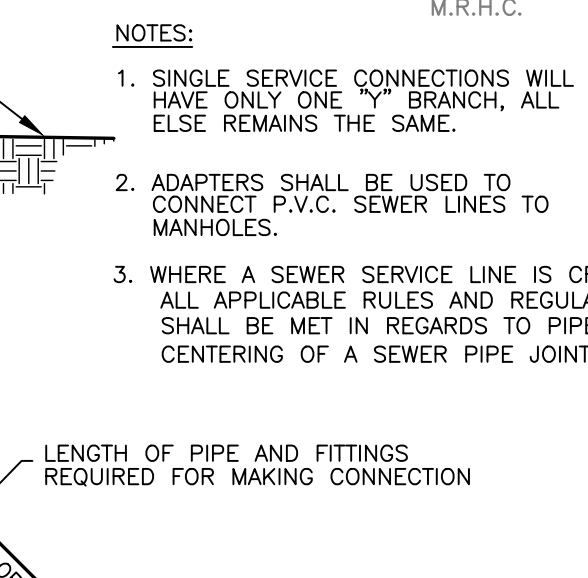
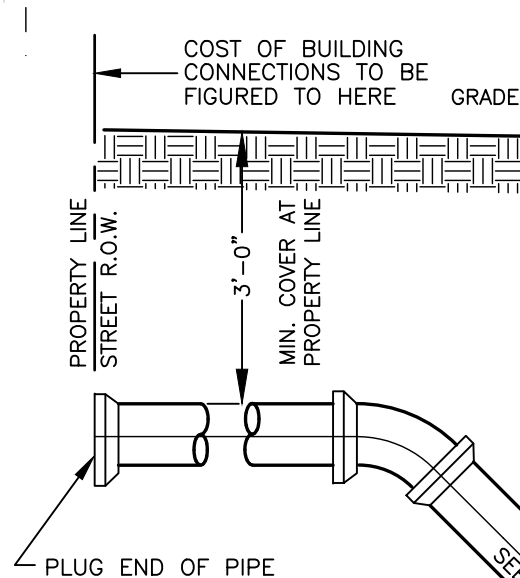

**BORING INSTALLATION**

PIPE CASING SIZE	CARRIER PIPE SIZE
12" 0.375 WALL	4"-6"
16" 0.375 WALL	8"
18" 0.375 WALL	10"
20" 0.375 WALL	12"
24" 0.375 WALL	14"
26" 0.375 WALL	16"
32" 0.375 WALL	18"
36" 0.375 WALL	20"
40" 0.375 WALL	24"

# UTILITY PLAN EL COYOTE SUBDIVISION

BEING A 12.166 ACRE TRACT OUT OF LOT 36 AND LOT 37, NEW CALEDONIA UNIT No. 3, RECORDED IN VOLUME 6, PAGES 47, MAP RECORDS, HIDALGO COUNTY, TEXAS

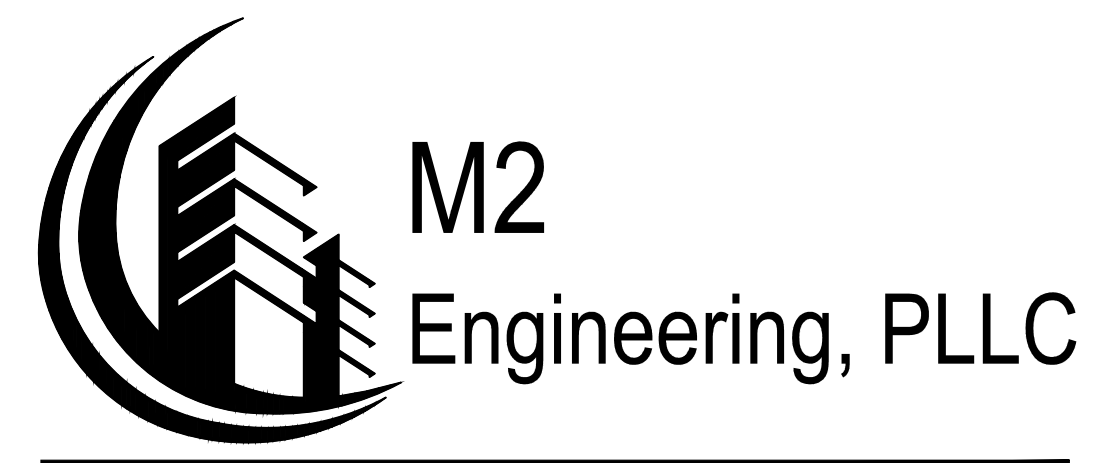

TBPELS FIRM REGISTRATION F-19545

1810 E. GRIFFIN PARKWAY  
MISSION TX 78572  
956-600-8628

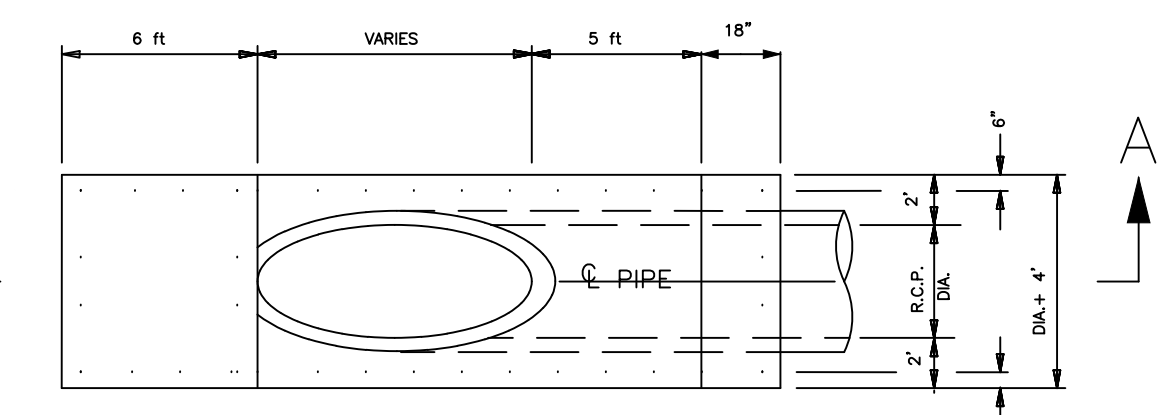
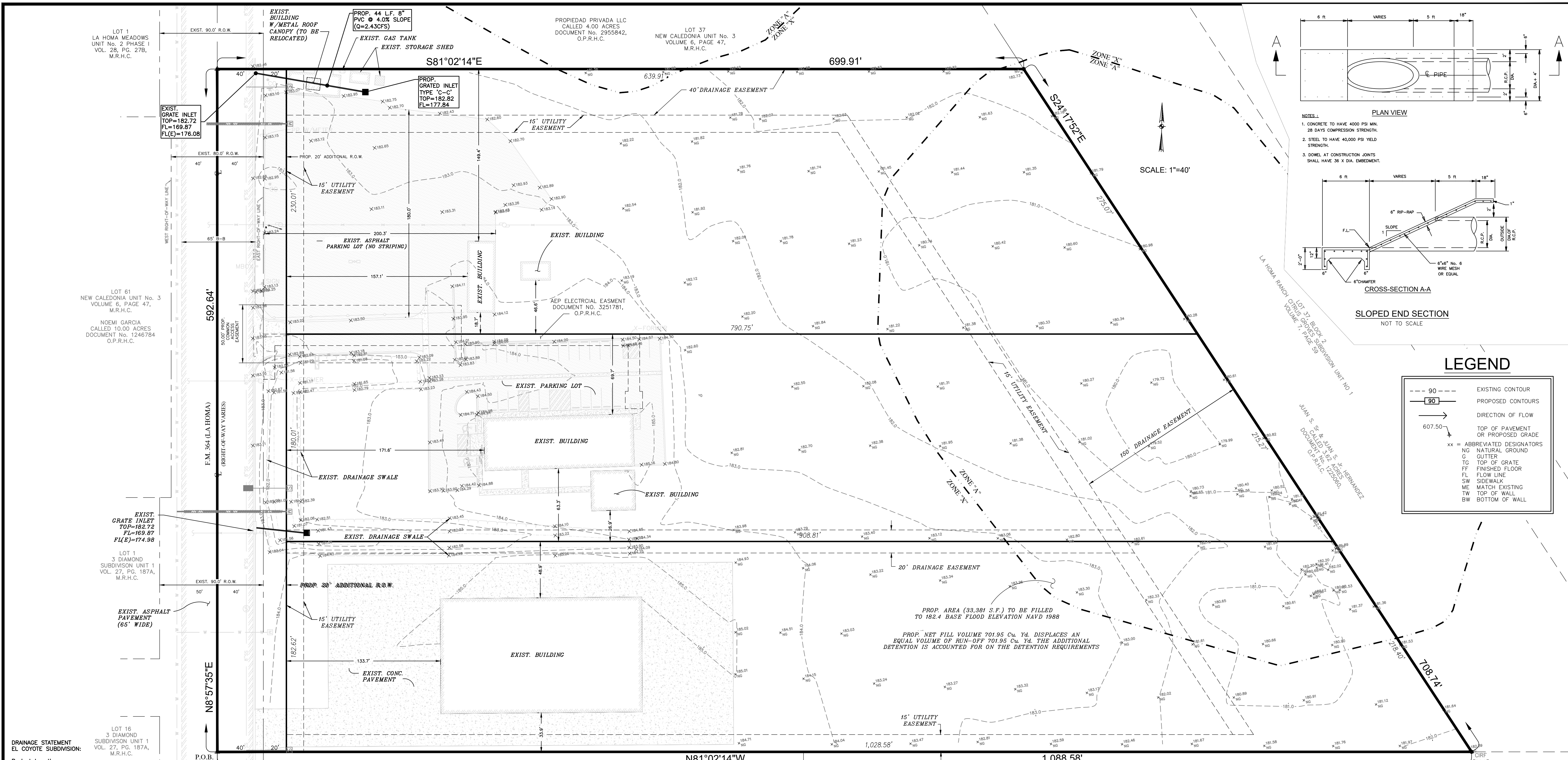

NOTES:  
 1. CONCRETE TO HAVE 4000 PSI MIN. 28 DAYS COMPRESSION STRENGTH.  
 2. STEEL TO HAVE 40,000 PSI YIELD STRENGTH.  
 3. DOWEL AT CONSTRUCTION JOINTS SHALL HAVE 36 X DIA. EMBEDMENT.

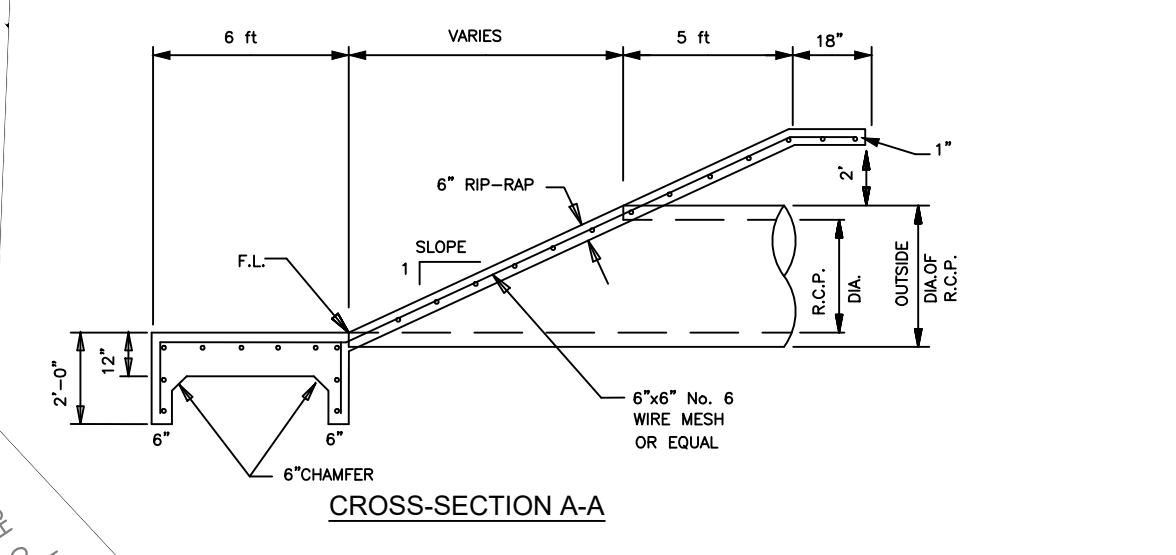

SLOPED END SECTION  
 NOT TO SCALE

**LEGEND**

	EXISTING CONTOUR
	PROPOSED CONTOURS
	DIRECTION OF FLOW
	TOP OF PAVEMENT OR PROPOSED GRADE
	ABBREVIATED DESIGNATORS
	NATURAL GROUND
	CUTTER
	TOP OF GRATE
	FINISHED FLOOR
	FLOW LINE
	SIDEWALK
	MATCH EXISTING
	TOP OF WALL
	BOTTOM OF WALL

**DRAINAGE STATEMENT**  
 EL COYOTE SUBDIVISION:

**Project Location**  
 THE PROPOSED SUBDIVISION CONSISTS OF A 3-Lot COMMERCIAL SUBDIVISION THAT FEATURES EXISTING COMMERCIAL BUILDINGS CONSISTING OF AN AUTOMOTIVE MECHANIC SHOP AND A USED CAR DEALERSHIP. THE PROJECT SITE IS LOCATED ON THE EAST SIDE OF NORTH LA HOMA ROAD (FM 364) APPROXIMATELY 1,700-Feet NORTH OF SUSANA STREET IN THE HIDALGO COUNTY PRECINCT NO. 3 IN THE CITY OF MISSION, TEXAS. THE SUBJECT TRACT IS DESCRIBED AS BEING A 12.166-ACRE TRACT OUT OF LOT 36 AND LOT 37, NEW CALEDONIA UNIT NO. 3, RECORDED IN VOLUME 6, PAGES 47, MAP RECORDS, HIDALGO COUNTY, TEXAS.

**FLOOD PLAN**  
 THE SITE IS LOCATED WITHIN ZONE "X" AREAS DETERMINED TO BE OUTSIDE THE 500-YEAR FLOODPLAIN AS DESCRIBED BY FEMA FLOOD PLAN COMMUNITY PANEL NO. 480343-02000 REVISED ON JUNE 6, 2000, AND WITHIN ZONE "A" AREAS, NO BASE FLOOD ELEVATION DETERMINED AS DESCRIBED BY FEMA FLOOD PLAN COMMUNITY PANEL NO. 480334-04000 REVISED NOVEMBER 16, 1982.

**SOILS INFORMATION**  
 ACCORDING TO THE SOIL SURVEY MAP FOR HIDALGO COUNTY, ISSUED BY THE USDA NATURAL RESOURCE CONSERVATION SERVICE, THE SOILS IN THIS AREA GENERALLY CONSIST OF: BRENNAN FINE SANDY LOAM WITH SLOPES BETWEEN 0 TO 1 PERCENT (HYDROLOGIC GROUP B), RACOMBES SANDY CLAY LOAM WITH SLOPE BETWEEN 0 TO 1 PERCENT (HYDROLOGIC GROUP B) AND RIO CLAY LOAM, PONDED (HYDROLOGIC GROUP C/D). SOILS PERTAINING TO HYDROLOGIC GROUP B ARE CLASSIFIED AS WELL DRAINED, AND HYDROLOGIC GROUP C/D SOILS ARE CLASSIFIED AS POORLY DRAINED.

**UNDEVELOPED CONDITIONS**  
 THE FEATURED PROJECT SITE CONSISTS OF 12.166-ACRE TRACT IS LOCATED ON THE EAST SIDE OF NORTH LA HOMA ROAD (FM 364) APPROXIMATELY 1,700-Feet NORTH OF SUSANA STREET, AND PRESENTLY HAS UNIFORM DRAINAGE PATTERNS WITH A GENERAL TENDENCY TO DRAIN WEST TO EAST TOWARDS THE REAR OF THE LOT AND THE ABUTTING TRACT ALONG THE EAST PROPERTY LINE. THE SITE CURRENTLY OPERATES AS A MECHANIC SHOP AND A CAR DEALERSHIP. THE PRE-DEVELOPED FLOWRATE FOR STORM RUNOFF IS 4.28 CFS FOR LOT 1, 3.69 CFS FOR LOT 2 AND 8.44 CFS FOR LOT 3 BASED ON A 10-YEAR STORM EVENT.

**DEVELOPED CONDITIONS**  
 THE CITY OF MISSION AND HIDALGO COUNTY DRAINAGE NO. 1 CRITERIA REQUIRE THAT THE STORM WATER RUNOFF GENERATED FROM THE DEVELOPED PROPERTY INCLUDING RUNOFF FROM UPSTREAM DRAINAGE AREAS SHALL BE DETAINED FOR A 50-YEAR FREQUENCY STORM EVENT, AND RELEASED INTO THE RECEIVING DOWNSTREAM SYSTEM AT THE PRE-DEVELOPED PEAK DISCHARGE RATE FOR A 10-YEAR STORM EVENT.

**EXHIBIT "A"** DETAILS THE PROPOSED DRAINAGE CALCULATIONS AND DRAINAGE AREA MAPS FOR THE FEATURED SITE. THE PROPOSED DEVELOPMENT FEATURES 3-Lots THAT ARE TO BE ZONED FOR COMMERCIAL PURPOSES, AND WILL SPAN ACROSS A 12.166-ACRE TRACT LOCATED ON THE EAST SIDE OF NORTH LA HOMA ROAD (FM 364) APPROXIMATELY 1,700-Feet NORTH OF SUSANA STREET.

THE PROPOSED DRAINAGE FOR THIS SUBDIVISION SHALL CONSIST OF SURFACE RUNOFF FROM LOTS 1 THRU 3 CONVEYED TOWARDS PROPOSED ON-SITE DRAINAGE DETENTION AREAS. FROM THEREON, THE DETAINED STORM RUNOFF WILL ULTIMATELY OUTFALL AND RELEASE TO AN EXISTING STORM SEWER SYSTEM ALONG LA HOMA ROAD WITH AN 8-INCH CHOKER AS REQUIRED BY THE TEXAS DEPARTMENT OF TRANSPORTATION (TXDOT), WHICH OWNS THE DRAINAGE INFRASTRUCTURE. DUE TO LOT 2 AND LOT 3 UTILIZING COMMON DETENTION AREAS AND RELEASING AT THE SAME OUTFALL, THE RELEASE RATE FOR LOT 2 AND LOT 3 WILL BE THE COMBINED FLOW RATE FOR AN 8-INCH CHOKER. THE REQUIRED DETENTION FOR A 50-YEAR FREQUENCY STORM EVENT IS 1.00 ACRE-FEET (43,688 CF) FOR LOT 1, 0.91 ACRE-FEET (39,514 CF) FOR LOT 2, AND 1.10 ACRE-FEET (47,770 CF) FOR LOT 3 RESPECTIVELY.

THE POST-DEVELOPED FLOW RATE FOR STORM RUN-OFF IS 29.75 CFS FOR LOT 1, 27.53 CFS FOR LOT 2 AND 31.75 CFS FOR LOT 3.

MIGUEL LOSOYA Jr.  
 CALLED 5.00 ACRES  
 DOCUMENT No. 1002692,  
 O.P.R.H.C.

LOT 7 BLOCK A  
 A.J. MCCOLL SUBDIVISION PORCION 6B  
 VOLUME 21, PAGE 598,  
 M.R.H.C.

WAYNE EVEAN SOJACK  
 CALLED 6.28 ACRES  
 DOCUMENT No. 2671368,  
 O.P.R.H.C.

LOT 35 BLOCK 1  
 NEW CALEDONIA SUBDIVISION UNIT NO 1  
 VOLUME 6, PAGE 47  
 M.R.H.C.

**ENGINEER'S CERTIFICATION**  
 I, THE UNDERSIGNED, EMIGDIO "MILO" SALINAS, A LICENSED PROFESSIONAL ENGINEER IN THE STATE OF TEXAS, HEREBY CERTIFY THAT PROPER ENGINEERING CONSIDERATION HAS BEEN GIVEN TO THIS PLAN.

DATED THIS THE 15TH DAY OF NOVEMBER 20 22

*Emigdio Salinas*  
 EMIGDIO "MILO" SALINAS, P.E.  
 LICENSED PROFESSIONAL ENGINEER No. 107703  
 FIRM REGISTERED No. F-19545

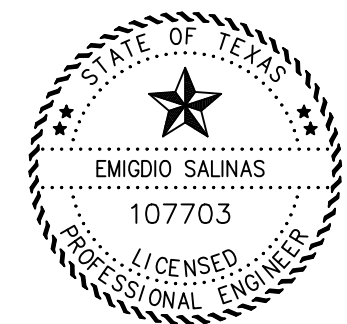

**INDEX OF SHEETS: EL COYOTE SUBDIVISION**

SHEET 1: HEADING; INDEX; LOCATION AND ETJ MAP; PRINCIPAL CONTACTS; MAP; LOT, STREETS, AND EASEMENT LAYOUT; SURVEYOR'S CERTIFICATION; OWNERS DEDICATION, CERTIFICATION, ATTESTATION; ENGINEERING CERTIFICATION; HIDALGO COUNTY IRRIGATION DISTRICT NO. 6 CERTIFICATION; COUNTY CLERK'S RECORDING CERTIFICATE; SHARYLAND WATER SUPPLY CORPORATION CERTIFICATE; LOT AREAS; PLAT NOTES AND RESTRICTIONS; DESCRIPTION (METES AND BOUNDS); HIDALGO COUNTY CERTIFICATE; HIDALGO DRAINAGE DISTRICT NO.1 CERTIFICATE; CITY APPROVAL CERTIFICATE.

SHEET 2: ENGINEERING REPORT, INCLUDING DESCRIPTION OF WATER AND SANITARY SEWER ENGINEER'S CERTIFICATION (ENGLISH AND SPANISH VERSION), WATER AND SANITARY LAYOUT; DETAILS;

SHEET 3: MAP OF TOPOGRAPHY AND DRAINAGE LAYOUT; STORM DRAINAGE CONSTRUCTION DETAILS; DRAINAGE REPORT INCLUDING DESCRIPTION OF DRAINAGE, ENGINEERING CERTIFICATION;

Lot 1 (At Permitting Stage)	43688	CF
REQUIRED DETENTION=	1618	CY
	1.00	AF
Lot 2 (At Permitting Stage)	43420	CF
REQUIRED DETENTION=	1608	CY
	1.00	AF
Lot 3 (At Permitting Stage)	51937	CF
REQUIRED DETENTION=	1924	CY
	1.19	AF
Floodzone Fill	18953	CF
REQUIRED DETENTION=	702	CY
	0.44	AF

# DRAINAGE PLAN

## EL COYOTE

### SUBDIVISION

BEING A 12.166 ACRE TRACT OUT OF LOT 36 AND LOT 37, NEW CALEDONIA UNIT No. 3, RECORDED IN VOLUME 6, PAGES 47, MAP RECORDS, HIDALGO COUNTY, TEXAS

**M2 Engineering, PLLC**

TBPELS FIRM REGISTRATION F-19545

1810 E. GRIFFIN PARKWAY  
 MISSION TX 78572  
 956-600-8628

**SHEET 3 OF 3**