



**Planning  
Department**

**Anthony Uresti**  
*Assistant Director*

**Main Office**

2818 S. Business Hwy 281  
Edinburg, Texas 78539  
Phone (956) 318-2840  
Fax (956) 318-2844

**Precinct No. 1 Substation**

1900 Joe Stephens Ave. Ste. A  
Weslaco, TX 78596  
Phone (956) 968-4734  
Fax (956) 973-7850

**Precinct No. 3 Substation**

2401 N. Moorefield Road  
Mission, Texas 78572  
Phone (956) 205-7045  
Fax (956) 205-7049

**PIPELINE AND UTILITY PERMIT APPLICATION PACKET**

THE STATE OF TEXAS

COUNTY OF HIDALGO

PRECINCT 1

**APPLICATION AND AGREEMENT FOR PIPELINE OR  
UTILITY PERMIT**

Date: 8/2/23

North Alamo Water Supply Corporation (hereinafter referred to as "Applicant") does hereby make application to the Hidalgo County through the Hidalgo County Planning Department (hereinafter referred to as "HCPD") to construct, maintain and repair pipelines or utilities across the easements, right-of-ways, property or property interest as described below.

Information required:

1. Name, Address and Phone number of Applicant:

North Alamo Water Supply Corporation Christy Sanchez

420 S Doolittle Rd Edinburg, Tx 78542 956-383-1618

2. Name, Address and Phone number of company or agency owning Pipeline or Utility (please indicate if same as Applicant):

Same

3. Name, Address and Phone number of operator of Pipeline or Utility (please indicate if same as Applicant):

Same

4. Name, Address and Phone number of contractor to install Pipeline or Utility:

Same





**Planning  
Department**

**Anthony Uresti**  
*Assistant Director*

**Main Office**

2818 S. Business Hwy 281  
Edinburg, Texas 78539  
Phone (956) 318-2840  
Fax (956) 318-2844

**Precinct No. 1 Substation**

1900 Joe Stephens Ave. Ste. A  
Weslaco, TX 78596  
Phone (956) 968-4734  
Fax (956) 973-7850

**Precinct No. 3 Substation**

2401 N. Moorefield Road  
Mission, Texas 78572  
Phone (956) 205-7045  
Fax (956) 205-7049

**PIPELINE AND UTILITY PERMIT APPLICATION PACKET**

12. Utility Crossing Coordinate X: 4946420.90 Y: -14653734.21  
(NAD 83 Texas South FIPS 4205 feet)
13. Number and size of lines:  
2" pvc casing, a 3/4" meter service to a 4" waterline.
14. Pressure (each line):  
35 PSI
15. Content (each line):  
Potable Water
16. Estimated date of installation of Pipeline or Utility:  
As soon as permit gets approved.



## Planning Department

**Anthony Uresti**  
*Assistant Director*

### Main Office

2818 S. Business Hwy 281  
Edinburg, Texas 78539  
Phone (956) 318-2840  
Fax (956) 318-2844

### Precinct No. 1 Substation

1900 Joe Stephens Ave. Ste. A  
Weslaco, TX 78596  
Phone (956) 968-4734  
Fax (956) 973-7850

### Precinct No. 3 Substation

2401 N. Moorefield Road  
Mission, Texas 78572  
Phone (956) 205-7045  
Fax (956) 205-7049

## PIPELINE AND UTILITY PERMIT APPLICATION PACKET

If requested permit is granted by HCPD, Applicant, in consideration thereof, agrees and binds itself as follows:

1. All pipelines or utilities herein will be horizontally placed within the right-of-way as determined by HCPD and at a minimum depth of five (5) feet below natural ground. Depth, horizontal, and vertical location shall be confirmed by HCPD Inspectors.
2. Location map, profile, and plans concerning the proposed pipeline or utility crossing will be furnished with this application.
3. HCPD will be notified in writing ten days prior to the beginning date of construction under this permit.
4. Applicant will bear the entire expense of all future relocations of any pipelines or utilities should such relocation, at the sole discretion of the Hidalgo County Commissioners Court, be necessary for improvements, alteration, or maintenance of Hidalgo County's easement or property of interest.
5. Applicant will notify the HCPD at least 48 hours prior to covering work and or completion of its work and removal of its equipment from the job site to permit HCPD to make an inspection.
6. Upon notification by the HCPD, the Applicant will promptly repair or rectify any deficiency or condition caused by the Applicant's operations or installations under this permit. Applicant will leave easement in as near the same condition or better, in the HCPD's sole judgment, as it existed prior to the commencement of the operations under this permit.
7. Hidalgo County shall not be liable or responsible for, and shall be saved and held harmless by Applicant, and further shall be indemnified by Applicant, from and against any and all suits, actions, losses, damages, claims, or liability of any character, type, or description, including all expenses of litigation, court costs, attorney's fees, and engineering fees for injury or death to any person, or injury to any property, received or sustained by any person or persons or property, arising out of, or occasioned by, directly or indirectly, the performance of Applicant under this agreement, including claims and damages arising in part from the negligence of Hidalgo County.



## Planning Department

**Anthony Uresti**  
*Assistant Director*

### Main Office

2818 S. Business Hwy 281  
Edinburg, Texas 78539  
Phone (956) 318-2840  
Fax (956) 318-2844

### Precinct No. 1 Substation

1900 Joe Stephens Ave. Ste. A  
Weslaco, TX 78596  
Phone (956) 968-4734  
Fax (956) 973-7850

### Precinct No. 3 Substation

2401 N. Moorefield Road  
Mission, Texas 78572  
Phone (956) 205-7045  
Fax (956) 205-7049

## PIPELINE AND UTILITY PERMIT APPLICATION PACKET

It is the expressed intent of the parties to this agreement that the indemnity provided for in this section is extended by Applicant to indemnify and protect Hidalgo County from the consequences of Hidalgo County's own negligence, whether that negligence is the sole or contributory cause of the resultant injury death, or damage.

Applicant further agrees to defend, at its own expense, with attorneys acceptable to Hidalgo County and on behalf of Hidalgo County, and in the name of Hidalgo County, any claim or litigation brought against Hidalgo County in connection with any such injury, death or damage.

Before construction is begun on such pipeline or utility crossings, Applicant will furnish to the HCPD a certificate of insurance (or other security approved by the HCPD) payable to Hidalgo County and protecting Hidalgo County (as an additional named insured) against any claims for personal injuries or damages to property resulting from the operations of Applicant, its agents, servants, employees, and contractors under this permit. Insurance is to be supplied in accordance with the attached Schedule A.

8. Hidalgo County makes no warranties, expressed or implied, in the granting of this permit; nor does Hidalgo County purport to grant any property interest or exclusive privileges whatsoever by granting such permit. It is specifically understood that Hidalgo County is not the agent for, nor does it act for, the fee owners or any persons or entities having any right, or title to possession of the land upon which Hidalgo County's easement or other property interest is located. Furthermore, in granting this permit Hidalgo County makes no representation or warranty that it has any property interest, including, but not limited to, an easement or right of way, in the land upon which Applicant constructs, maintains, repairs, or modifies the pipelines or utilities, made the subject of this application, nor does Hidalgo County make any representation or warranty as to the validity, quality or extent of such property interest, if any. Applicant acknowledges its understanding that Hidalgo County in granting this permit, does not convey or grant to Applicant any rights, title or interest for which is has no legal authority to grant or convey.
9. Applicant binds itself to comply with all federal, state, and local laws or regulations and will obtain all necessary permits from all local and federal agencies required by law before installation or construction is begun.



## Planning Department

**Anthony Uresti**  
*Assistant Director*

### Main Office

2818 S. Business Hwy 281  
Edinburg, Texas 78539  
Phone (956) 318-2840  
Fax (956) 318-2844

### Precinct No. 1 Substation

1900 Joe Stephens Ave. Ste. A  
Weslaco, TX 78596  
Phone (956) 968-4734  
Fax (956) 973-7850

### Precinct No. 3 Substation

2401 N. Moorefield Road  
Mission, Texas 78572  
Phone (956) 205-7045  
Fax (956) 205-7049

## PIPELINE AND UTILITY PERMIT APPLICATION PACKET

10. Applicant will install its pipelines and utilities in a manner and location as shown in the plans and specifications filed with HCPD in support of this application for permit. Hidalgo County Planning Department's representative may at any time make such inspection as such engineer or other representation may deem necessary to assure that the construction of the pipeline or utilities is in accordance with the plans and specifications submitted, and said engineer or representative shall have the right to temporarily suspend Applicant's work if necessary, while such inspection is being made. Should Applicant not install the pipelines or utilities in accordance with the terms and conditions of this permit, Applicant agrees that Hidalgo County shall have the right to require, at Applicant's expense, the removal of the pipelines and utilities and its replacement in conformance to said plans and specifications and conditions of this permit. Hidalgo County may revoke this permit and suspend all work hereunder if it is determined by Hidalgo County that the pipelines or utilities are not being installed in accordance with such plans and specifications and conditions of this permit. The suspension or revocation of this permit shall not be a basis for a claim for damages against Hidalgo County.

11. Except in emergency situations where it is necessary to protect life and property, Applicant will not make any change, modification, or alteration in or to the pipelines or utilities without first securing a new or amended permit from Hidalgo County prior to the making of any such change. Applicant will maintain the pipelines or utilities hereby authorized in good and safe condition, and in accordance with plans, specifications, and this permit.

12. Applicant agrees to pay HCPD a permit fee to cover administrative costs in the amount of **\$500.00**, plus a reimbursement to HCPD for any necessary engineering fees which may be incurred for the study and processing of the Application. This fee will permit a single pipeline or utility to be within County right-of-way. Applicant further agrees to pay an additional fee of **\$500.00** for each additional line included in permit application at the same location; however, more than one location may be included in a single application.

Requests to lay additional line or lines, not included in an initial permit application, must be made by separate application, with new permit fees paid accordingly and support data provided.



## Planning Department

**Anthony Uresti**  
*Assistant Director*

### Main Office

2818 S. Business Hwy 281  
Edinburg, Texas 78539  
Phone (956) 318-2840  
Fax (956) 318-2844

### Precinct No. 1 Substation

1900 Joe Stephens Ave. Ste. A  
Weslaco, TX 78596  
Phone (956) 968-4734  
Fax (956) 973-7850

### Precinct No. 3 Substation

2401 N. Moorefield Road  
Mission, Texas 78572  
Phone (956) 205-7045  
Fax (956) 205-7049

## PIPELINE AND UTILITY PERMIT APPLICATION PACKET

Permit fees may be waived where Applicant is a state, county, municipality, or a special political subdivision.

13. The Applicant is allowed one hundred twenty days (120) from the granting of the permit to start construction of the pipelines or utilities crossings. Once started, the Applicant is allowed ninety (90) days to complete all work under such permit. All construction must be completed within two hundred ten (210) days from the date of issuance of permit. Upon application, extension of the time periods set forth in this paragraph may be granted by the Hidalgo County Commissioners Court. Such applications for extension must be received by HCPD at least thirty days before the expiration of the two hundred ten (210) days period. A new permit fee, in accordance with Paragraph 12 hereof, will be charged for each extension granted.

Construction of any pipeline or utility crossing will not begin until written approval has been given by HCPD.

14. All provisions of the Pipeline and Utility Permit Administration Policy of Hidalgo County, if any, and all amendments thereto, are hereby incorporated herein as part of the terms and conditions of this permit for all purposes.
15. Applicant warrants and represents that it has secured from all fee owners of the involved property an easement or other property rights to construct, repair or modify the pipeline or utility in the manner set forth herein.
16. This Pipeline and Utility Permit if granted by Hidalgo County is subject to any and all other requirements, specifications and conditions listed in Exhibit A attached hereto.
17. Hidalgo County requires all coordinates of all utility crossings. Horizontal datum to be in NAD 83 State Plane Texas South 4205 feet and vertical datum in NAVD 88 Geoid 12a.



**Planning  
Department**

**Anthony Uresti**  
Assistant Director

**Main Office**

2818 S. Business Hwy 281  
Edinburg, Texas 78539  
Phone (956) 318-2840  
Fax (956) 318-2844

**Precinct No. 1 Substation**

1900 Joe Stephens Ave. Ste. A  
Weslaco, TX 78596  
Phone (956) 968-4734  
Fax (956) 973-7850

**Precinct No. 3 Substation**

2401 N. Moorefield Road  
Mission, Texas 78572  
Phone (956) 205-7045  
Fax (956) 205-7049

**PIPELINE AND UTILITY PERMIT APPLICATION PACKET**

18. This permit constitutes the entire agreement between the parties with regard to the subject matter hereof, and all prior agreements, representations, and negotiations between the parties regarding the subject matter are hereby superseded. This permit shall not be altered or amended except by an agreement in writing executed by the parties hereto.

19. Applicant warrants and represents that its undersigned representative has full authority to bind Applicant to the terms and conditions of the foregoing Application and Agreement for Pipeline or Utility Permit.

DATED this 2nd day of August, 2023.

Christy Sanchez

(Name of Applicant – Printed or Typed)

By: *Christy Sanchez*  
Signature

Title: New Accounts Supervisor

STATE OF TEXAS  
COUNTY OF HIDALGO

SUBSCRIBED AND SWORN TO before me the Applicant,  
Christy Sanchez, on this 2nd day of August, 2023,  
to which witness my hand and seal of office.

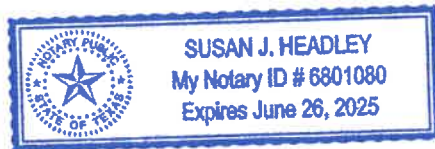

*Susan J. Headley*  
Notary Public for the State of Texas

My Commission Expires: *6/26/2025*



**Planning  
Department**

**Anthony Uresti**  
*Assistant Director*

**Main Office**

2818 S. Business Hwy 281  
Edinburg, Texas 78539  
Phone (956) 318-2840  
Fax (956) 318-2844

**Precinct No. 1 Substation**

1900 Joe Stephens Ave. Ste. A  
Weslaco, TX 78596  
Phone (956) 968-4734  
Fax (956) 973-7850

**Precinct No. 3 Substation**

2401 N. Moorefield Road  
Mission, Texas 78572  
Phone (956) 205-7045  
Fax (956) 205-7049

**PIPELINE AND UTILITY PERMIT APPLICATION PACKET**

**APPROVAL OF APPLICATION BY  
HIDALGO COUNTY PLANNING DEPARTMENT**

Came on for consideration this \_\_\_\_\_ day of \_\_\_\_\_,  
20\_\_\_\_. The above and foregoing Application for Pipeline and Utility  
Permit, and after consideration of the same by the Hidalgo County  
Commissioners Court, said Application and Agreement for Pipeline or  
Utility Permit is hereby APPROVED.

HIDALGO COUNTY:

\_\_\_\_\_  
Richard F. Cortez, County Judge



## Planning Department

**Anthony Uresti**  
*Assistant Director*

### Main Office

2818 S. Business Hwy 281  
Edinburg, Texas 78539  
Phone (956) 318-2840  
Fax (956) 318-2844

### Precinct No. 1 Substation

1900 Joe Stephens Ave. Ste. A  
Weslaco, TX 78596  
Phone (956) 968-4734  
Fax (956) 973-7850

### Precinct No. 3 Substation

2401 N. Moorefield Road  
Mission, Texas 78572  
Phone (956) 205-7045  
Fax (956) 205-7049

## PIPELINE AND UTILITY PERMIT APPLICATION PACKET

### EXHIBIT A

(Please insert description of project location and supporting documents for proposed utility work)



# JUAN A. CONTRERAS

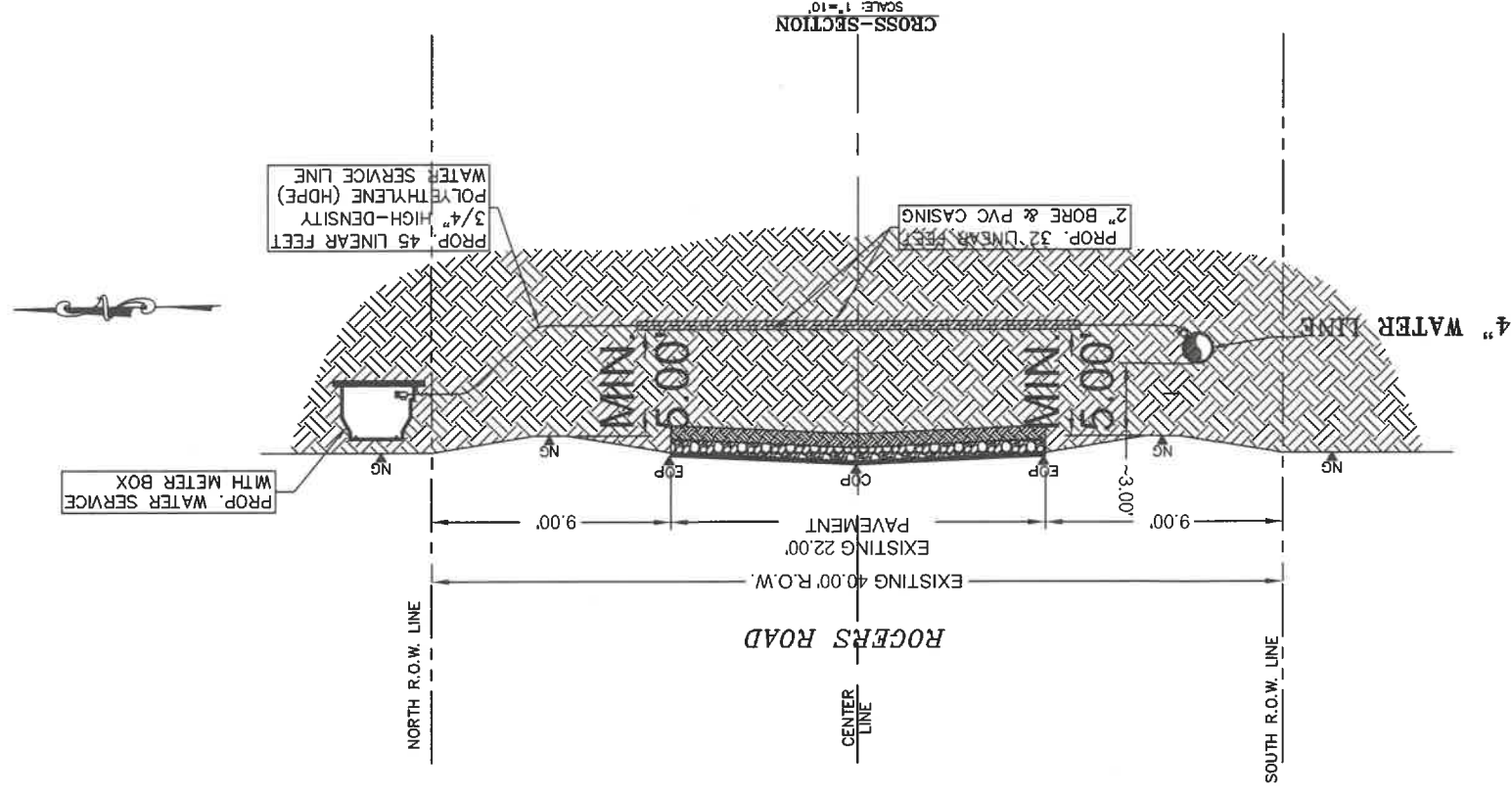
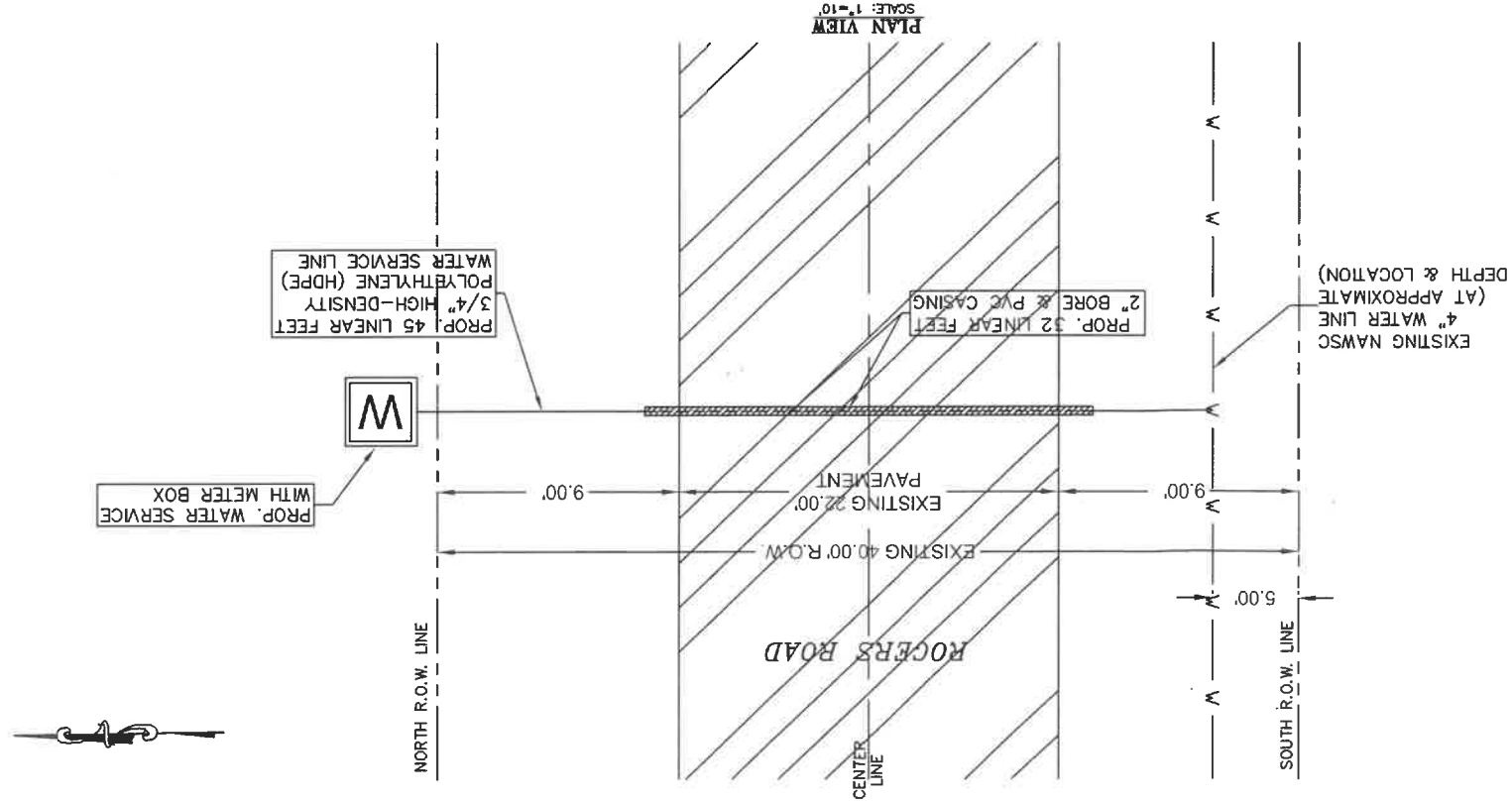

LOCATION OF PROPOSE BORE CROSSING IS APPROXIMATE 3,130' FEET EAST FROM THE SOUTH EAST CORNER OF FM 493 AND ROGERS ROAD 2" PVC CASING 3/4" METER SERVICE TO A 4" WATER LINE WILL BORE ROGERS ROAD FROM SOUTH TO NORTH 4' DEEP.

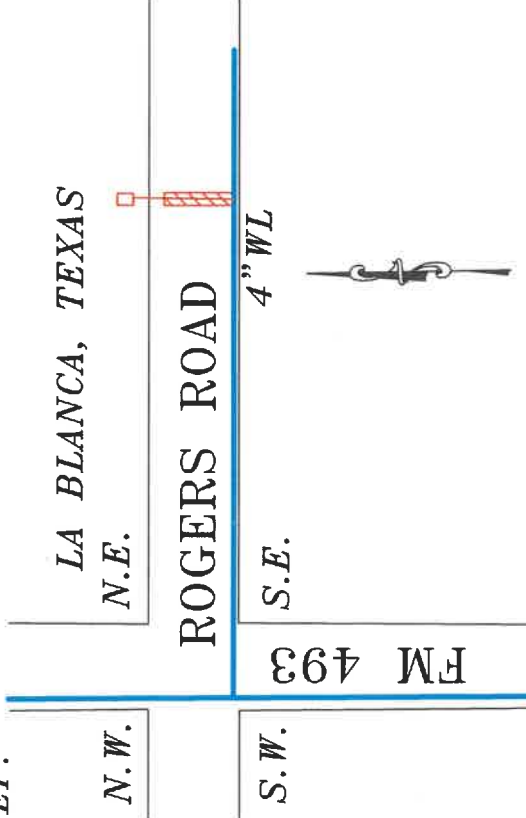

| LEGEND |                    |
|--------|--------------------|
| NG     | NATURAL GROUND     |
| EOP    | EDGE OF PAVEMENT   |
| COP    | CENTER OF PAVEMENT |
| PROP.  | PROPOSE            |
| EXIST. | EXISTING           |
| ROW    | RIGHT-OF-WAY       |
| MIN.   | MINIMUM            |

**GENERAL NOTES:**

1. THE LOCATION OF UNDERGROUND UTILITIES SHOWN ON THESE PLANS ARE BASED ON OBSERVATION OF ABOVE GROUND STRUCTURES, LINES SPOTTED BY THE OWNER, AND UTILITY SPOTTING. ACTUAL LOCATION OF THESE UTILITIES MAY VARY, AND ADDITIONAL BURIED UTILITIES MAY BE ENCOUNTERED UPON EXCAVATION.
2. BEFORE BEGINNING CONSTRUCTION, THE CONTRACTOR SHALL CALL FOR UTILITY SPOTTING BY THE APPROPRIATE AGENCY AND VERIFY THE LOCATION OF THESE UTILITIES TO HIS SATISFACTION. (1-800-DIG-TESS)
3. ANY DAMAGE CAUSED TO EXISTING STRUCTURES AND/OR UTILITIES BY THE CONTRACTOR SHALL BE THE CONTRACTOR'S RESPONSIBILITY TO CORRECT AT HIS EXPENSE.
4. ANY DAMAGE TO PROPERTY, OUTSIDE THE CONSTRUCTION ZONE, CAUSED BY THE CONTRACTOR, SHALL BE THE CONTRACTOR'S RESPONSIBILITY TO CORRECT AT HIS EXPENSE.

WATER SERVICE LINE  
2-INCH BORE  
ROGERS ROAD  
LA BLANCA, TEXAS

**NORTH ALAMO  
WATER SUPPLY CORP.**

7/27/23  
"A"

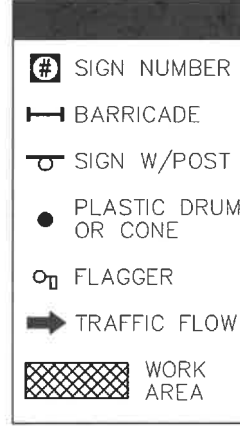
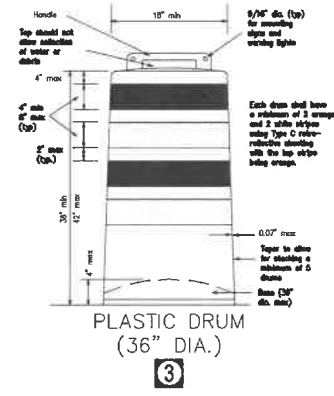
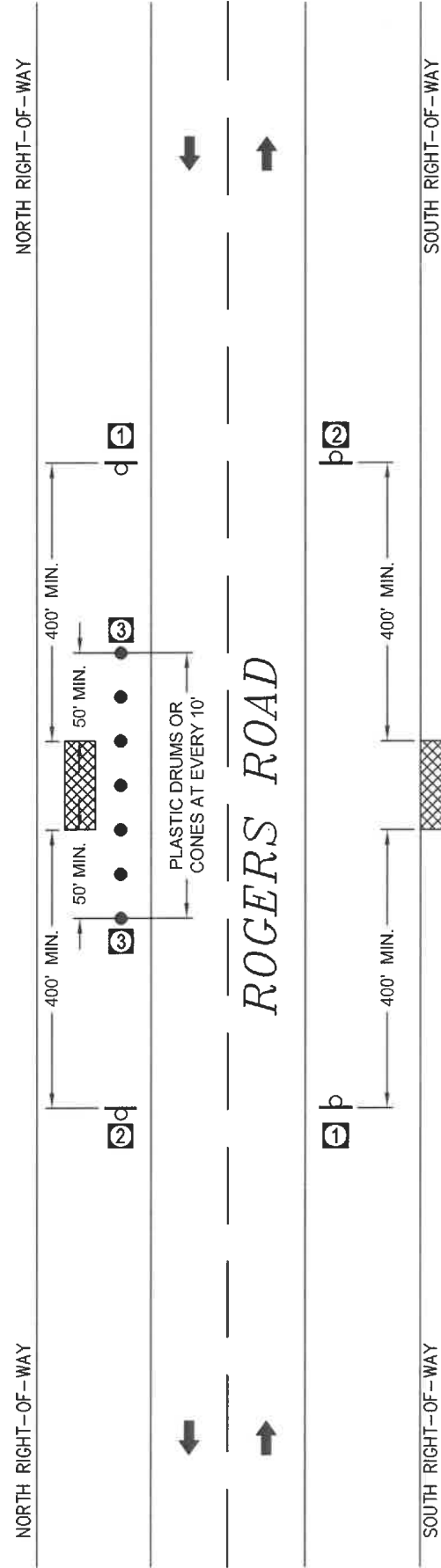

**GENERAL NOTES:**

1. ALL SIGNS, PLASTIC DRUMS, AND BARRICADES SHALL BE IN ACCORDANCE WITH THE TEXAS MANUAL ON UNIFORM TRAFFIC CONTROL DEVICES (TMUTCD) 2014.
2. REFER TO TxDOT 'BARRICADE AND CONSTRUCTION CHANNELIZING DEVICES STANDARD PLANS' AND TO 'TRAFFIC CONTROL PLAN STANDARD PLANS' FOR ADDITIONAL REQUIREMENTS AND SPECIFICATIONS.

**TRAFFIC CONTROL PLAN (TCP)**

WATER SERVICE LINE  
2-INCH BORE  
ROGERS ROAD  
LA BLANCA, TEXAS

NORTH ALAMO  
WATER SUPPLY CORP.

7/27/23  
"B"