



Planning Department

Anthony Uresti
Director of Planning

Main Office

2818 S. Business Hwy 281
Edinburg, Texas 78539
Phone (956) 318-2840

Precinct No. 1 Substation

1900 Joe Stephens Ave. Ste. A
Weslaco, TX 78596
Phone (956) 968-4734

Precinct No. 3 Substation

2401 N. Moorefield Road
Mission, Texas 78572
Phone (956) 205-7045

PIPELINE AND UTILITY PERMIT APPLICATION PACKET

Contact the Director of Hidalgo County Planning Department to discuss the scope of the project

1. Please return the following for processing (in duplicate)
 - a. Permit application form.
 - b. Locator map.
 - c. Plans/profile of pipe or utility crossing.
 - d. Applicant's insurance certificate (in compliance with Schedule A).

2. Check payable to Hidalgo County Planning Department for appropriate fee(s) upon approval by the Hidalgo County Commissioners Court.

Hidalgo County Planning Department will make effort to process permit applications within a minimum of 30 days after receipt of the above required information.

All questions regarding this application should be addressed to the Director of Hidalgo County Planning Department.



**Planning
Department**

Anthony Uresti
Director of Planning

Main Office

2818 S. Business Hwy 281
Edinburg, Texas 78539
Phone (956) 318-2840

Precinct No. 1 Substation

1900 Joe Stephens Ave. Ste. A
Weslaco, TX 78596
Phone (956) 968-4734

Precinct No. 3 Substation

2401 N. Moorefield Road
Mission, Texas 78572
Phone (956) 205-7045

PIPELINE AND UTILITY PERMIT APPLICATION PACKET

THE STATE OF TEXAS

COUNTY OF HIDALGO

PRECINCT _____

**APPLICATION AND AGREEMENT FOR PIPELINE OR
UTILITY PERMIT**

Date: 2/22/24

Spectrum 3937759/WE24E (hereinafter referred to as "Applicant") does hereby make application to the Hidalgo County through the Hidalgo County Planning Department (hereinafter referred to as "HCPD") to construct, maintain and repair pipelines or utilities across the easements, right-of-ways, property or property interest as described below.

Information required:

1. Name, Address and Phone number of Applicant:

Robert Martinez 956-535-3264

1514 South 77 Sunshine Strip suite 1 Harlingen, Texas 78550

2. Name, Address and Phone number of company or agency owning Pipeline or Utility (please indicate if same as Applicant):

Robert Martinez 956-535-3264

1514 South 77 Sunshine Strip suite 1 Harlingen, Texas 78550

3. Name, Address and Phone number of operator of Pipeline or Utility (please indicate if same as Applicant):

Robert Martinez 956-535-3264

1514 South 77 Sunshine Strip suite 1 Harlingen, Texas 78550

4. Name, Address and Phone number of contractor to install Pipeline or Utility:

Andrew Garza 1-956-929-8965

Infinite Communications 820 West Expressway 83 Donna, Tx. 78537

Visit Hidalgo County Planning Department on the web at www.co.hidalgo.tx.us



Planning Department

Anthony Uresti
Director of Planning

Main Office

2818 S. Business Hwy 281
Edinburg, Texas 78539
Phone (956) 318-2840

Precinct No. 1 Substation

1900 Joe Stephens Ave. Ste. A
Weslaco, TX 78596
Phone (956) 968-4734

Precinct No. 3 Substation

2401 N. Moorefield Road
Mission, Texas 78572
Phone (956) 205-7045

PIPELINE AND UTILITY PERMIT APPLICATION PACKET

12. Utility Crossing Coordinate X: 26.187386 Y: -98.063670
(NAD 83 Texas South FIPS 4205 feet)
13. Number and size of lines:
NA
14. Pressure (each line):
NA
15. Content (each line):
NA
16. Estimated date of installation of Pipeline or Utility:
As soon as the permit is approved.



Planning Department

Anthony Uresti
Director of Planning

Main Office

2818 S. Business Hwy 281
Edinburg, Texas 78539
Phone (956) 318-2840

Precinct No. 1 Substation

1900 Joe Stephens Ave. Ste. A
Weslaco, TX 78596
Phone (956) 968-4734

Precinct No. 3 Substation

2401 N. Moorefield Road
Mission, Texas 78572
Phone (956) 205-7045

PIPELINE AND UTILITY PERMIT APPLICATION PACKET

If requested permit is granted by HCPD, Applicant, in consideration thereof, agrees and binds itself as follows:

1. All pipelines or utilities herein will be horizontally placed within the right-of-way as determined by HCPD and at a minimum depth of five (5) feet below natural ground. Depth, horizontal, and vertical location shall be confirmed by HCPD Inspectors.
2. Location map, profile, and plans concerning the proposed pipeline or utility crossing will furnished with this application.
3. HCPD will be notified in writing ten days prior to the beginning date of construction under this permit.
4. Applicant will bear the entire expense of all future relocations of any pipelines or utilities should such relocation, at the sole discretion of the Hidalgo County Commissioners Court, be necessary for improvements, alteration, or maintenance of Hidalgo County's easement or property of interest.
5. Applicant will notify the HCPD at least 48 hours prior to covering work and or completion of its work and removal of its equipment from the job site to permit HCPD to make an inspection.
6. Upon notification by the HCPD, the Applicant will promptly repair or rectify any deficiency or condition caused by the Applicant's operations or installations under this permit. Applicant will leave easement in as near the same condition or better, in the HCPD's sole judgment, as it existed prior to the commencement of the operations under this permit.
7. Hidalgo County shall not be liable or responsible for, and shall be saved and held harmless by Applicant, and further shall be indemnified by Applicant, from and against any and all suits, actions, losses, damages, claims, or liability of any character, type, or description, including all expenses of litigation, court costs, attorney's fees, and engineering fees for injury or death to any person, or injury to any property, received or sustained by any person or persons or property, arising out of, or occasioned by, directly or indirectly, the performance of Applicant under this agreement, including claims and damages arising in part from the negligence of Hidalgo County.



Planning Department

Anthony Uresti
Director of Planning

Main Office

2818 S. Business Hwy 281
Edinburg, Texas 78539
Phone (956) 318-2840

Precinct No. 1 Substation

1900 Joe Stephens Ave. Ste. A
Weslaco, TX 78596
Phone (956) 968-4734

Precinct No. 3 Substation

2401 N. Moorefield Road
Mission, Texas 78572
Phone (956) 205-7045

PIPELINE AND UTILITY PERMIT APPLICATION PACKET

It is the expressed intent of the parties to this agreement that the indemnity provided for in this section is extended by Applicant to indemnify and protect Hidalgo County from the consequences of Hidalgo County's own negligence, whether that negligence is the sole or contributory cause of the resultant injury death, or damage.

Applicant further agrees to defend, at its own expense, with attorneys acceptable to Hidalgo County and on behalf of Hidalgo County, and in the name of Hidalgo County, any claim or litigation brought against Hidalgo County in connection with any such injury, death or damage.

Before construction is begun on such pipeline or utility crossings, Applicant will furnish to the HCPD a certificate of insurance (or other security approved by the HCPD) payable to Hidalgo County and protecting Hidalgo County (as an additional named insured) against any claims for personal injuries or damages to property resulting from the operations of Applicant, its agents, servants, employees, and contractors under this permit. Insurance is to be supplied in accordance with the attached Schedule A.

8. Hidalgo County makes no warranties, expressed or implied, in the granting of this permit; nor does Hidalgo County purport to grant any property interest or exclusive privileges whatsoever by granting such permit. It is specifically understood that Hidalgo County is not the agent for, nor does it act for, the fee owners or any persons or entities having any right, or title to possession of the land upon which Hidalgo County's easement or other property interest is located. Furthermore, in granting this permit Hidalgo County makes no representation or warranty that it has any property interest, including, but not limited to, an easement or right of way, in the land upon which Applicant constructs, maintains, repairs, or modifies the pipelines or utilities, made the subject of this application, nor does Hidalgo County make any representation or warranty as to the validity, quality or extent of such property interest, if any. Applicant acknowledges its understanding that Hidalgo County in granting this permit, does not convey or grant to Applicant any rights, title or interest for which is has no legal authority to grant or convey.
9. Applicant binds itself to comply with all federal, state, and local laws or regulations and will obtain all necessary permits from all local and federal agencies required by law before installation or construction is begun.



Planning Department

Anthony Uresti
Director of Planning

Main Office

2818 S. Business Hwy 281
Edinburg, Texas 78539
Phone (956) 318-2840

Precinct No. 1 Substation

1900 Joe Stephens Ave. Ste. A
Weslaco, TX 78596
Phone (956) 968-4734

Precinct No. 3 Substation

2401 N. Moorefield Road
Mission, Texas 78572
Phone (956) 205-7045

PIPELINE AND UTILITY PERMIT APPLICATION PACKET

10. Applicant will install its pipelines and utilities in a manner and location as shown in the plans and specifications filed with HCPD in support of this application for permit. Hidalgo County Planning Department's representative may at any time make such inspection as such engineer or other representation may deem necessary to assure that the construction of the pipeline or utilities is in accordance with the plans and specifications submitted, and said engineer or representative shall have the right to temporarily suspend Applicant's work if necessary, while such inspection is being made. Should Applicant not install the pipelines or utilities in accordance with the terms and conditions of this permit, Applicant agrees that Hidalgo County shall have the right to require, at Applicant's expense, the removal of the pipelines and utilities and its replacement in conformance to said plans and specifications and conditions of this permit. Hidalgo County may revoke this permit and suspend all work hereunder if it is determined by Hidalgo County that the pipelines or utilities are not being installed in accordance with such plans and specifications and conditions of this permit. The suspension or revocation of this permit shall not be a basis for a claim for damages against Hidalgo County.
11. Except in emergency situations where it is necessary to protect life and property, Applicant will not make any change, modification, or alteration in or to the pipelines or utilities without first securing a new or amended permit from Hidalgo County prior to the making of any such change. Applicant will maintain the pipelines or utilities hereby authorized in good and safe condition, and in accordance with plans, specifications, and this permit.
12. Applicant agrees to pay HCPD a permit fee to cover administrative costs in the amount of **\$500.00**, plus a reimbursement to HCPD for any necessary engineering fees which may be incurred for the study and processing of the Application. This fee will permit a single pipeline or utility to be within County right-of-way. Applicant further agrees to pay an additional fee of **\$500.00** for each additional line included in permit application at the same location; however, more than one location may be included in a single application.

Requests to lay additional line or lines, not included in an initial permit application, must be made by separate application, with new permit fees paid accordingly and support data provided.



Planning Department

Anthony Uresti
Director of Planning

Main Office

2818 S. Business Hwy 281
Edinburg, Texas 78539
Phone (956) 318-2840

Precinct No. 1 Substation

1900 Joe Stephens Ave. Ste. A
Weslaco, TX 78596
Phone (956) 968-4734

Precinct No. 3 Substation

2401 N. Moorefield Road
Mission, Texas 78572
Phone (956) 205-7045

PIPELINE AND UTILITY PERMIT APPLICATION PACKET

Permit fees may be waived where Applicant is a state, county, municipality, or a special political subdivision.

13. The Applicant is allowed one hundred twenty days (120) from the granting of the permit to start construction of the pipelines or utilities crossings. Once started, the Applicant is allowed ninety (90) days to complete all work under such permit. All construction must be completed within two hundred ten (210) days from the date of issuance of permit. Upon application, extension of the time periods set forth in this paragraph may be granted by the Hidalgo County Commissioners Court. Such applications for extension must be received by HCPD at least thirty days before the expiration of the two hundred ten (210) days period. A new permit fee, in accordance with Paragraph 12 hereof, will be charged for each extension granted.

Construction of any pipeline or utility crossing will not begin until written approval has been given by HCPD.

14. All provisions of the Pipeline and Utility Permit Administration Policy of Hidalgo County, if any, and all amendments thereto, are hereby incorporated herein as part of the terms and conditions of this permit for all purposes.
15. Applicant warrants and represents that it has secured from all fee owners of the involved property an easement or other property rights to construct, repair or modify the pipeline or utility in the manner set forth herein.
16. This Pipeline and Utility Permit if granted by Hidalgo County is subject to any and all other requirements, specifications and conditions listed in Exhibit A attached hereto.
17. Hidalgo County requires all coordinates of all utility crossings. Horizontal datum to be in NAD 83 State Plane Texas South 4205 feet and vertical datum in NAVD 88 Geoid 12a.



**Planning
Department**

Anthony Uresti
Director of Planning

Main Office

2818 S. Business Hwy 281
Edinburg, Texas 78539
Phone (956) 318-2840

Precinct No. 1 Substation

1900 Joe Stephens Ave. Ste. A
Weslaco, TX 78596
Phone (956) 968-4734

Precinct No. 3 Substation

2401 N. Moorefield Road
Mission, Texas 78572
Phone (956) 205-7045

PIPELINE AND UTILITY PERMIT APPLICATION PACKET

18. This permit constitutes the entire agreement between the parties with regard to the subject matter hereof, and all prior agreements, representations, and negotiations between the parties regarding the subject matter are hereby superseded. This permit shall not be altered or amended except by an agreement in writing executed by the parties hereto.

19. Applicant warrants and represents that its undersigned representative has full authority to bind Applicant to the terms and conditions of the foregoing Application and Agreement for Pipeline or Utility Permit.

DATED this 22nd day of February, 2024.

Robert Martinez
(Name of Applicant – Printed or Typed)

By: Robert Martinez
Signature

Title: Construction Coordinator

STATE OF TEXAS
COUNTY OF HIDALGO

SUBSCRIBED AND SWORN TO before me the Applicant,
Robert Martinez, on this 22nd day of February, 2024,
to which witness my hand and seal of office.

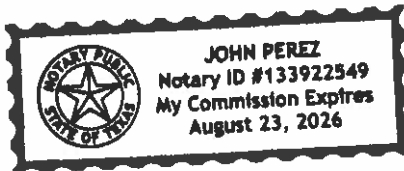

[Signature]
Notary Public for the State of Texas

My Commission Expires: August 23, 2026



**Planning
Department**

Anthony Uresti
Director of Planning

Main Office

2818 S. Business Hwy 281
Edinburg, Texas 78539
Phone (956) 318-2840

Precinct No. 1 Substation

1900 Joe Stephens Ave. Ste. A
Weslaco, TX 78596
Phone (956) 968-4734

Precinct No. 3 Substation

2401 N. Moorefield Road
Mission, Texas 78572
Phone (956) 205-7045

PIPELINE AND UTILITY PERMIT APPLICATION PACKET

**APPROVAL OF APPLICATION BY
HIDALGO COUNTY PLANNING DEPARTMENT**

Came on for consideration this _____ day of _____,
20____. The above and foregoing Application for Pipeline and Utility
Permit, and after consideration of the same by the Hidalgo County
Commissioners Court, said Application and Agreement for Pipeline or
Utility Permit is hereby APPROVED.

HIDALGO COUNTY:

Richard F. Cortez, County Judge



Planning Department

Anthony Uresti
Director of Planning

Main Office

2818 S. Business Hwy 281
Edinburg, Texas 78539
Phone (956) 318-2840

Precinct No. 1 Substation

1900 Joe Stephens Ave. Ste. A
Weslaco, TX 78596
Phone (956) 968-4734

Precinct No. 3 Substation

2401 N. Moorefield Road
Mission, Texas 78572
Phone (956) 205-7045

PIPELINE AND UTILITY PERMIT APPLICATION PACKET

EXHIBIT A

(Please insert description of project location and supporting documents for proposed utility work)



CERTIFICATE OF LIABILITY INSURANCE

DATE (MM/DD/YYYY)

3/20/2023

THIS CERTIFICATE IS ISSUED AS A MATTER OF INFORMATION ONLY AND CONFERS NO RIGHTS UPON THE CERTIFICATE HOLDER. THIS CERTIFICATE DOES NOT AFFIRMATIVELY OR NEGATIVELY AMEND, EXTEND OR ALTER THE COVERAGE AFFORDED BY THE POLICIES BELOW. THIS CERTIFICATE OF INSURANCE DOES NOT CONSTITUTE A CONTRACT BETWEEN THE ISSUING INSURER(S), AUTHORIZED REPRESENTATIVE OR PRODUCER, AND THE CERTIFICATE HOLDER.

IMPORTANT: If the certificate holder is an ADDITIONAL INSURED, the policy(ies) must have ADDITIONAL INSURED provisions or be endorsed. If SUBROGATION IS WAIVED, subject to the terms and conditions of the policy, certain policies may require an endorsement. A statement on this certificate does not confer rights to the certificate holder in lieu of such endorsement(s).

PRODUCER Assurance, a Marsh & McLennan Agency LLC company 20 North Martingale Road Suite 100 Schaumburg IL 60173	CONTACT NAME: Sharon Panos PHONE (A/C. No. Ext): (847) 908-8714 E-MAIL ADDRESS: Sharon.Panos@MarshMMA.com		FAX (A/C. No): (847) 440-9123													
	<table border="1"> <thead> <tr> <th>INSURER(S) AFFORDING COVERAGE</th> <th>NAIC #</th> </tr> </thead> <tbody> <tr> <td>INSURER A : Travelers Indemnity Company of</td> <td>25666</td> </tr> <tr> <td>INSURER B : Travelers Property Casualty Co</td> <td>25674</td> </tr> <tr> <td>INSURER C : Accident Fund National Insuran</td> <td>12305</td> </tr> <tr> <td>INSURER D :</td> <td></td> </tr> <tr> <td>INSURER E :</td> <td></td> </tr> <tr> <td>INSURER F :</td> <td></td> </tr> </tbody> </table>			INSURER(S) AFFORDING COVERAGE	NAIC #	INSURER A : Travelers Indemnity Company of	25666	INSURER B : Travelers Property Casualty Co	25674	INSURER C : Accident Fund National Insuran	12305	INSURER D :		INSURER E :		INSURER F :
INSURER(S) AFFORDING COVERAGE	NAIC #															
INSURER A : Travelers Indemnity Company of	25666															
INSURER B : Travelers Property Casualty Co	25674															
INSURER C : Accident Fund National Insuran	12305															
INSURER D :																
INSURER E :																
INSURER F :																
INSURED Infinite Communications Incorporated 1855 Cassat Ave., Unit 11 Jacksonville FL 32210	INFICOM-01															

COVERAGES

CERTIFICATE NUMBER: 1084485231

REVISION NUMBER:

THIS IS TO CERTIFY THAT THE POLICIES OF INSURANCE LISTED BELOW HAVE BEEN ISSUED TO THE INSURED NAMED ABOVE FOR THE POLICY PERIOD INDICATED. NOTWITHSTANDING ANY REQUIREMENT, TERM OR CONDITION OF ANY CONTRACT OR OTHER DOCUMENT WITH RESPECT TO WHICH THIS CERTIFICATE MAY BE ISSUED OR MAY PERTAIN, THE INSURANCE AFFORDED BY THE POLICIES DESCRIBED HEREIN IS SUBJECT TO ALL THE TERMS, EXCLUSIONS AND CONDITIONS OF SUCH POLICIES. LIMITS SHOWN MAY HAVE BEEN REDUCED BY PAID CLAIMS.

INSR LTR	TYPE OF INSURANCE	ADDL INSD	SUBR WVD	POLICY NUMBER	POLICY EFF (MM/DD/YYYY)	POLICY EXP (MM/DD/YYYY)	LIMITS
A	<input checked="" type="checkbox"/> COMMERCIAL GENERAL LIABILITY <input type="checkbox"/> CLAIMS-MADE <input checked="" type="checkbox"/> OCCUR GEN'L AGGREGATE LIMIT APPLIES PER: <input type="checkbox"/> POLICY <input checked="" type="checkbox"/> PRO-JECT <input type="checkbox"/> LOC <input type="checkbox"/> OTHER:			DTCO2T065050COF23	3/22/2023	3/22/2024	EACH OCCURRENCE \$ 1,000,000 DAMAGE TO RENTED PREMISES (Ea occurrence) \$ 300,000 MED EXP (Any one person) \$ 5,000 PERSONAL & ADV INJURY \$ 1,000,000 GENERAL AGGREGATE \$ 2,000,000 PRODUCTS - COMP/OP AGG \$ 2,000,000 \$
A	<input checked="" type="checkbox"/> AUTOMOBILE LIABILITY <input checked="" type="checkbox"/> ANY AUTO <input type="checkbox"/> OWNED AUTOS ONLY <input type="checkbox"/> SCHEDULED AUTOS <input checked="" type="checkbox"/> HIRED AUTOS ONLY <input checked="" type="checkbox"/> NON-OWNED AUTOS ONLY			8102T0659902326G	3/22/2023	3/22/2024	COMBINED SINGLE LIMIT (Ea accident) \$ 1,000,000 BODILY INJURY (Per person) \$ BODILY INJURY (Per accident) \$ PROPERTY DAMAGE (Per accident) \$ \$
B	<input checked="" type="checkbox"/> UMBRELLA LIAB <input checked="" type="checkbox"/> OCCUR <input type="checkbox"/> EXCESS LIAB <input type="checkbox"/> CLAIMS-MADE <input type="checkbox"/> DED <input checked="" type="checkbox"/> RETENTION \$ 10,000			CUP2T0783462326	3/22/2023	3/22/2024	EACH OCCURRENCE \$ 10,000,000 AGGREGATE \$ 10,000,000 \$
C	WORKERS COMPENSATION AND EMPLOYERS' LIABILITY ANY PROPRIETOR/PARTNER/EXECUTIVE OFFICER/MEMBER EXCLUDED? (Mandatory in NH) If yes, describe under DESCRIPTION OF OPERATIONS below	Y/N N	N/A	WCP100037103	3/22/2023	3/22/2024	<input checked="" type="checkbox"/> PER STATUTE <input type="checkbox"/> OTH-ER E.L. EACH ACCIDENT \$ 1,000,000 E.L. DISEASE - EA EMPLOYEE \$ 1,000,000 E.L. DISEASE - POLICY LIMIT \$ 1,000,000
B	Leased & Rented Equipment			QT6303T313490TIL22	3/22/2023	3/22/2024	Limit 250,000

DESCRIPTION OF OPERATIONS / LOCATIONS / VEHICLES (ACORD 101, Additional Remarks Schedule, may be attached if more space is required)
 Proof of Insurance Only

CERTIFICATE HOLDER**CANCELLATION**

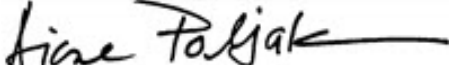
County of Hidalgo Hidalgo county planning dept. 2818 South Business Hwy 281 Edinburg TX 78539	SHOULD ANY OF THE ABOVE DESCRIBED POLICIES BE CANCELLED BEFORE THE EXPIRATION DATE THEREOF, NOTICE WILL BE DELIVERED IN ACCORDANCE WITH THE POLICY PROVISIONS. AUTHORIZED REPRESENTATIVE 
--	---

© 1988-2015 ACORD CORPORATION. All rights reserved.

Survey Info			
PRISM ID:	382728 - Map	Originator:	Erney, Bobby D
Construction Type:	Greenfield	Const Supervisor:	Castro, Daniel T
Process State:	S1 - Survey in Review	Construction Coordinator:	Barrera, Edelm F (P2745812) - p2745812@state2ip
Project Status:	In Progress	Total Project Cost:	470181.94
Input Date:	10/04/22	Total Placements:	322
Hub:	WD - WESLACO-TX	Tentative Svc Dt:	
Node:	WD21 - WD21	Entity:	1904
Construction Due Date:		Priority Class:	
		Business/Company Name:	GF FTTH El Encantado Subdivision
		Address:	2500 N. HUITO RD
		City/State/Zip:	DONNA, TX 78527
		Cross Street:	
		Prog Dev Status:	
		Coax:	N/A
		Fiber:	N/A
		Construction Survey Completed:	Yes
		Construction Sub Type:	

Project Design			
Entity:	1904-South Texas-TX	Management Area:	TR1-South Texas
Map Grid:	Lat: 28.Deg 11' 37" N Long: 98.Deg 0' 2" E	Services from Survey:	
Project Approved Date:		Orig Tentative Svc Date:	
Construction Sub Type:		Node Capacity:	
		Special Initiative:	
Design Log	New Design	Design Number:	2960515

NODE: WE24E, WE25E
INSTANCE: TEXMEX
MAP: 26.1910798318111,
-98.0623131621431
AFTER PRINT
PAGE 1 OF 16

This OLT was moved to the bottom.

power supply locations
 this will be 2 OLTs
 each as 2 amps draw.
 Fiber to the home.

TIE POINT

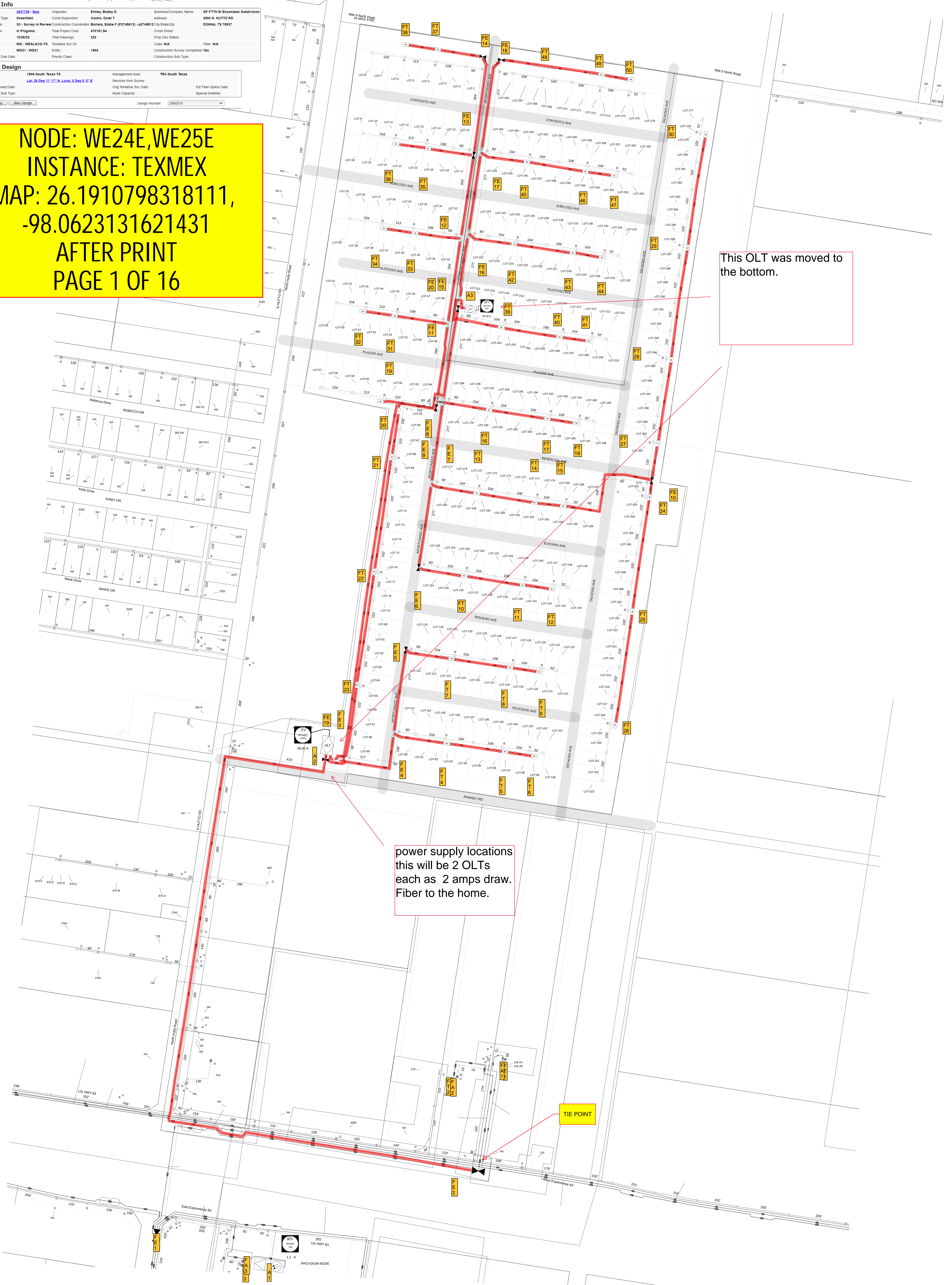

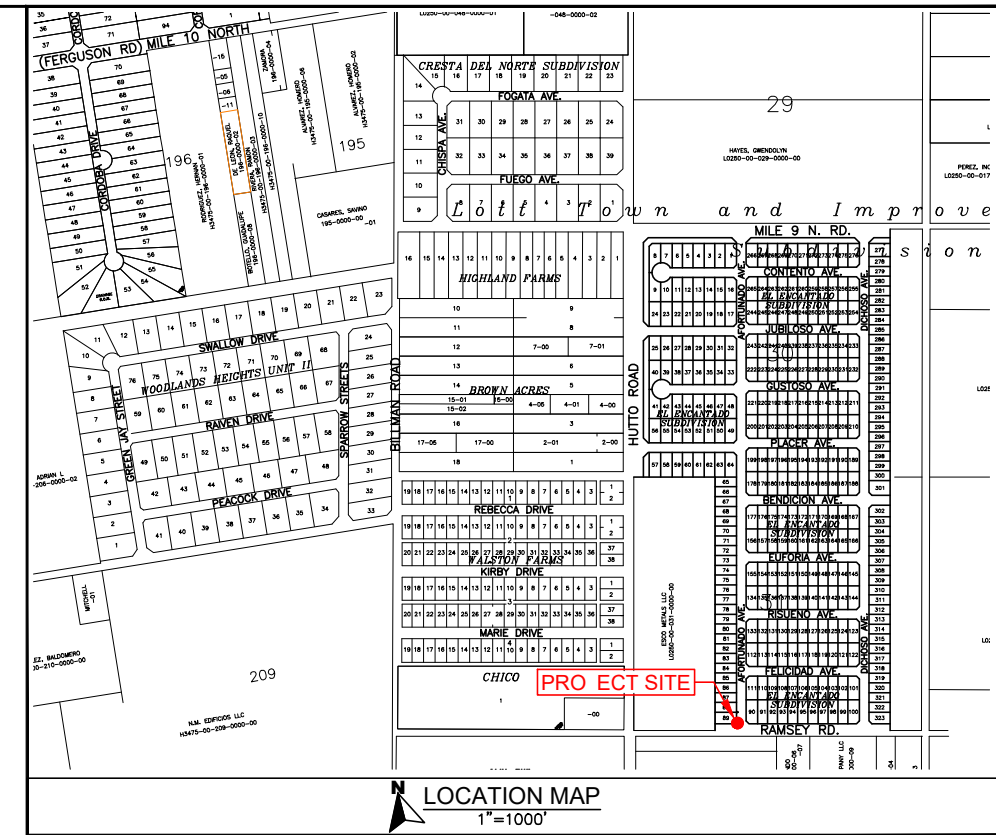
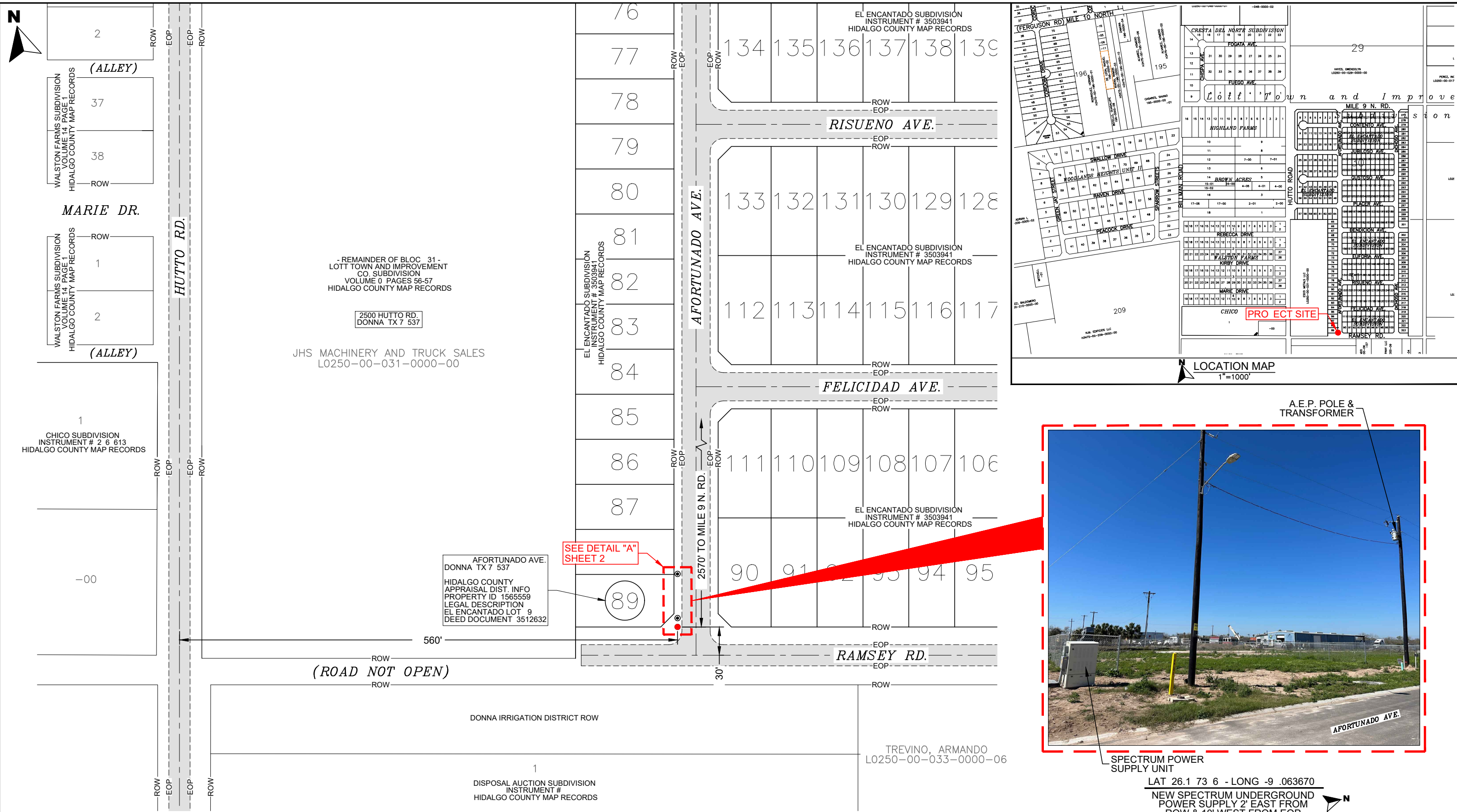

A.E.P. POLE & TRANSFORMER
 SPECTRUM POWER SUPPLY UNIT
 LAT 26.1 73 6 - LONG -9 .063670
 NEW SPECTRUM UNDERGROUND POWER SUPPLY 2' EAST FROM ROW & 10' WEST FROM EOP

PROJECT NAME: SPECTRUM POWER SUPPLY AT EL ENCANTADO SUBDIVISION
 ADDRESS: ALONG WEST SIDE OF AFORTUNADO AVE. APPROX. 560' EAST FROM HUTTO ROAD
 PRISM #: 3937759 DATE: 2/21/2024 SCALE: 1" = 100'
 PAGE: 1 OF 3 CITY: DONNA

LEGEND			
	EXIST. POWER POLE		EXIST. PEDESTAL
	PROP. POWER POLE		PROP. PEDESTAL
	RIGHT OF WAY LINE		EXIST. UNDERGROUND
	EDGE OF PAVEMENT		PROP. UNDERGROUND
	EDGE OF SIDEWALK		PROP. OVERLASH
	RISER		PROP. NEW BUILD



ABBREVIATIONS	
H.C.A.D.	HIDALGO COUNTY APPRAISAL DISTRICT
H.C.M.R.	HIDALGO COUNTY MAP RECORDS
PI	PROPERTY IDENTIFICATION
PROP.	PROPOSED
EXIST.	EXISTING
ROW	RIGHT-OF-WAY
EOP	EDGE OF PAVEMENT
CL	CENTER LINE
SW	SIDEWALK
ST.	STREET
RD.	ROAD

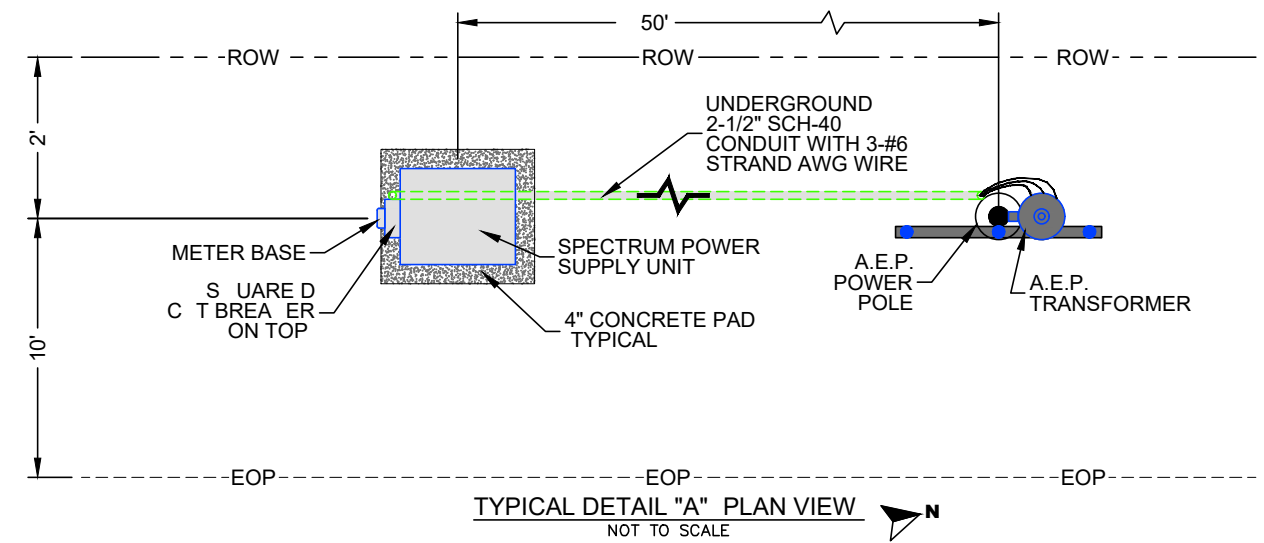
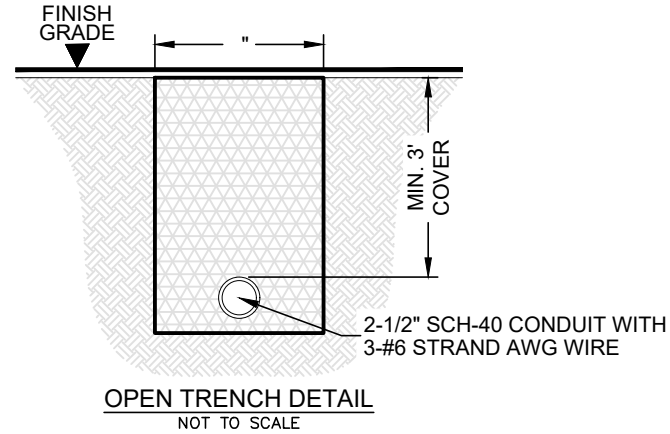

- NOTES**
1. ALL INFORMATION SHOWN ON THIS MAP HAVE BEEN GRAPHICALLY PLOTTED FROM FIELD OBSERVATION AND FROM AVAILABLE PUBLIC RECORDS. ALL MEASUREMENTS ARE APPROXIMATE. EXCAVATOR IS RESPONSIBLE TO FIELD VERIFY AND NOTIFY SPECTRUM SUPERVISOR IF THERE IS ANY CONFLICT BEFORE WORK STARTS.
 2. IT IS THE RESPONSIBILITY OF THE EXCAVATOR TO VERIFY AND FIELD LOCATE ANY AND ALL UNDERGROUND UTILITIES AND OBSTRUCTIONS PRIOR TO EXCAVATION. IT SHALL BE THE EXPENSE OF THE EXCAVATOR FOR ANY AND ALL DAMAGES INCURRED.

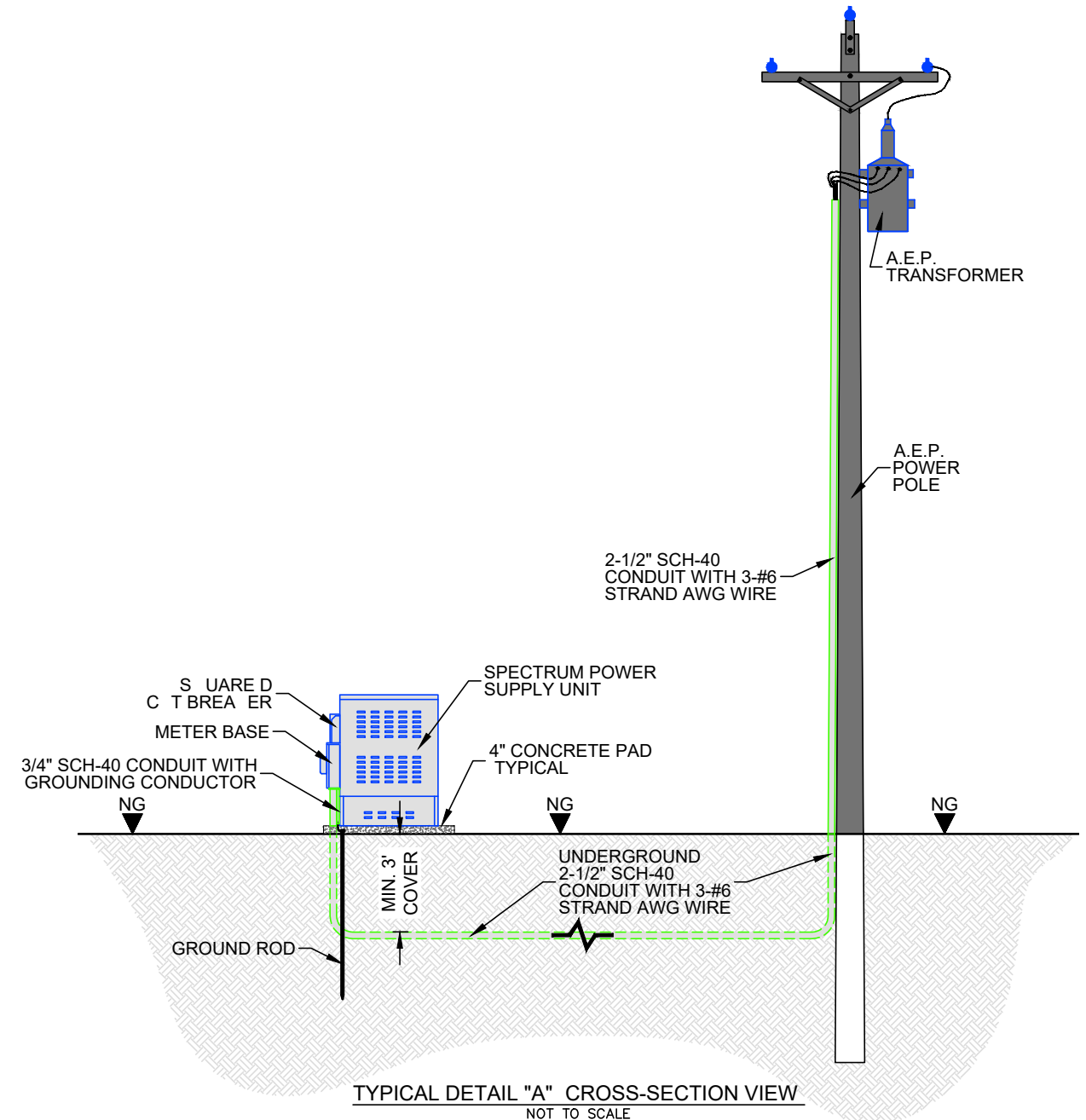

PROJECT NAME: SPECTRUM POWER SUPPLY AT EL ENCANTADO SUBDIVISION
 ADDRESS: ALONG WEST SIDE OF AFORTUNADO AVE. APPROX. 560' EAST FROM HUTTO ROAD
 PRISM #: 3937759 DATE: 2/21/2024 SCALE: NTS
 PAGE: 2 OF 3 CITY: DONNA

LEGEND			
	EXIST. POWER POLE		EXIST. PEDESTAL
	PROP. POWER POLE		PROP. PEDESTAL
---	RIGHT OF WAY LINE	-----	EXIST. UNDERGROUND
---	EDGE OF PAVEMENT	-----	PROP. UNDERGROUND
---	EDGE OF SIDEWALK	-----	PROP. OVERLASH
	RISER	-----	PROP. NEW BUILD

ThermalPro® Access Outdoor Equipment Cabinets



POWER SUPPLY UNIT / CABINET PICTURE-1
NOT TO SCALE

Features & Benefits

- Full featured general purpose cabinets
- Wide variety of sizes available
- Telecordia GR-487 compliant
- Broad selection of options to tailor-fit to any application
- Available fully integrated as turn-key solution

Features

- Single bay outdoor equipment cabinet, up to 23RU
- Optional 14.5" H battery pedestal
- Optional 6" H pad mount plinth
- Front and rear rails available
- Fixed racks, adjustable, 19" or 23"
- Swing-out racks, 19" or 23"
- Front door with wind-stop and padlock hasps
- Rear access panel or door
- Universal pole / wall mount brackets
- Double wall roof for protection against solar load
- Environmental gasket seals for all access points
- Multiple cable entry locations
- Heavy-duty aluminum construction
- Durable powder coat paint finish



Overview

The ThermalPro® Access Series is a comprehensive line of general purpose cabinets with flexibility to fit in any industry. With a broad range of sizes and available options, the ThermalPro Access Series cabinets are well suited for a variety of applications. Whether it is cell site backhaul, fiber network distribution, transit or utilities, we have the expertise to configure these cabinets to fit your needs.

Optional Equipment

- Air conditioners, heat exchangers and fan systems
- AC power equipment: load centers, outlets, surge suppression
- DC power equipment: rectifier systems
- Battery back up strings and UPS systems
- Generator connectors and power meter bases
- Cabinet and battery heaters
- Fiber routing raceways and management
- Fiber optic pigtails, splitters and distribution panels
- Protection or cross-connect panels

This product may be protected by one or more patents • For further information, please visit: www.ppc-online.com/patents

customerservice@ppc-online.com • 1-800-800-6652 • www.ppc-online.com

ThermalPro® Access Outdoor Equipment Cabinets



Technical Data

Dimensions

10U-18 (H x W x D)	13U-18 (H x W x D)	13U-24 (H x W x D)	17U-18 (H x W x D)	17U-24 (H x W x D)	20U-24 (H x W x D)	23U-24 (H x W x D)	23U-36 (H x W x D)
mm (in)	mm (in)	mm (in)	mm (in)	mm (in)	mm (in)	mm (in)	mm (in)
660 x 813 x 457 (26 x 32 x 18)	813 x 813 x 457 (32 x 32 x 18)	813 x 813 x 610 (32 x 32 x 24)	965 x 813 x 457 (38 x 32 x 18)	965 x 813 x 610 (38 x 32 x 24)	1118 x 813 x 610 (44 x 32 x 24)	1270 x 813 x 610 (50 x 32 x 24)	1270 x 813 x 914 (50 x 32 x 36)

Mechanical Drawing

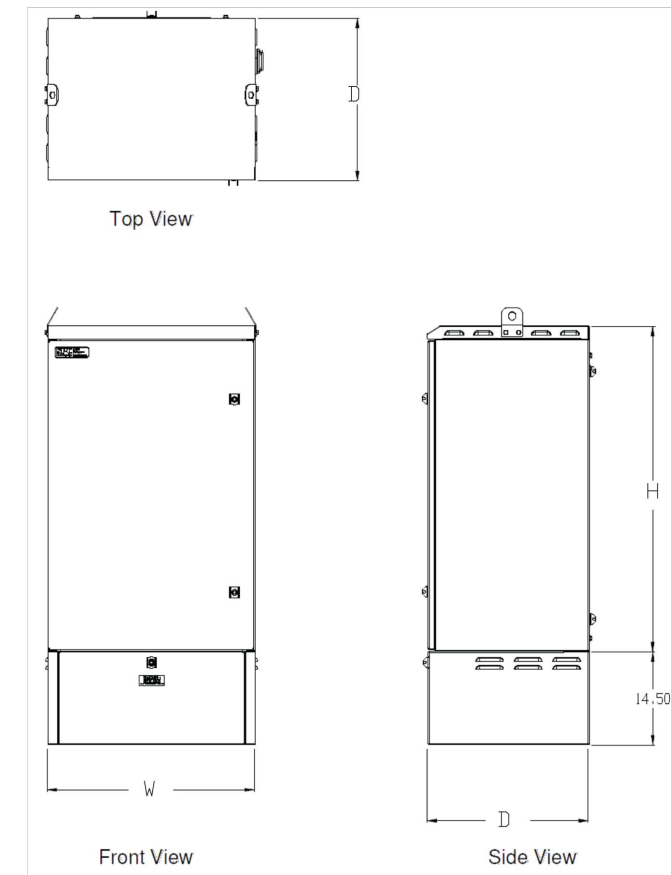

rev1_07282020

Shown with optional battery pedestal

This product may be protected by one or more patents • For further information, please visit: www.ppc-online.com/patents

customerservice@ppc-online.com • 1-800-800-6652 • www.ppc-online.com

POWER SUPPLY UNIT / CABINET TYPICAL DETAIL & SPECIFICATIONS

NOT TO SCALE

PROJECT NAME: SPECTRUM POWER SUPPLY AT EL ENCANTADO SUBDIVISION		
ADDRESS: ALONG WEST SIDE OF AFORTUNADO AVE. APPROX. 560' EAST FROM HUTTO ROAD		
PRISM #: 3937759	DATE: 2 / 21 / 2024	SCALE: NTS
PAGE: 3 OF 3	CITY: DONNA	

LEGEND

⊙	EXIST. POWER POLE	■	EXIST. PEDESTAL
⊕	PROP. POWER POLE	□	PROP. PEDESTAL
—ROW—	RIGHT OF WAY LINE	-----	EXIST. UNDERGROUND
—EOP—	EDGE OF PAVEMENT	-----	PROP. UNDERGROUND
—SW—	EDGE OF SIDEWALK	-----	PROP. OVERLASH
Ⓡ	RISER	-----	PROP. NEW BUILD



PART # SELECTED