

**COUNTY OF HIDALGO - URBAN COUNTY PROGRAM
Price Quotation Form**

Price Quotation Form must be submitted to Urban County for pre-approval prior to the purchase. Use additional forms as needed.

VENDOR #1 Name: Park Place Recreational Designs Person Contacted: Bob Adherns
Phone #: 210-416-6482

Item #	Description of Items	Quantity	Price Per unit	Total Amount
1	4 Row Bleachers	6	2,942.00	17,652.00
2	Freight -NO CHARGE FEE	1		
3				
4				
5				
6				
TOTAL:				17,652.00



VENDOR #2 Name: Plat RGV, LLC Person Contacted: Luis E. Montemayor
Phone #: 956-735-6212

Item #	Description of Items	Quantity	Price Per unit	Total Amount
1	4 Row Bleachers	6	3,099.00	18,594.00
2	Freight	1	4,995.00	4,995.00
3				
4				
5				
6				
TOTAL:				23,589.00

VENDOR #3 Name: Belson Outdoors Person Contacted: Vickie Nitto
Phone #: 800-323-5664

Item #	Description of Items	Quantity	Price Per unit	Total Amount
1	4 Row Bleachers	6	4,595.00	27,570.00
2	Freight	1	2,438.82	2,438.82
3				
4				
5				
6		10	20.00	200.00
TOTAL:				30,208.82

Recommendation: Lowest Responsible Quoted: Park Place Recreation Design, Inc.

Requested by:  (USE BLUE INK) Date: 12/14/19
UCP Assistant Director Approval:  (USE BLUE INK) Date: 12/14/19



URBAN COUNTY PROGRAM

1916 TESORO ST. • PHARR, TEXAS 78577 • (956) 787-8127 FAX (956) 318-2988 •E-MAIL: ucp@co.hidalgo.tx.us

REQUEST FOR QUOTE

Hidalgo County Urban County Program is requesting a quote for the procurement of Park Equipment for the City of Penitas 2023 Parks and Recreational Facilities Improvements Project.

All quotes must contain a price and terms of a delivery date with a validity period of at least forty five (45) days. If you are unable to provide us with a quote please indicate so in writing.

All questions or discussions on this request for quotation must be directed to: **Eloisa Peña**

All quotes must be submitted no later than Monday December 9, 2024 by 3:00 pm

Contact: Eloisa Peña	Phone: (956) 787-8127 x2235 Email: eloisa.pena@co.hidalgo.tx.us		
Description	Qty	Unit Price	Extended Price
4 Row Bleachers	6	2,942.00	17,652.00
Shipping/Freight NO CHARGE FEE	1		
Total			\$17,652.00

Note: Notice of tax exempt (if selected) tax exempt form shall be provided.

Robert k. Adherns
Representative Name

12/04/2024
Date

bob@miricaleparkplace.com
Email Address

210-416-6482
Phone

FIRST TEAM SPORTS INC.
HUTCHINSON, KS 67501
1-800-649-3688
www.firstteaminc.com

FAN4-1FP-15
PRODUCT SUBMITTAL

BLACK POWDER COATED STEEL FRAME

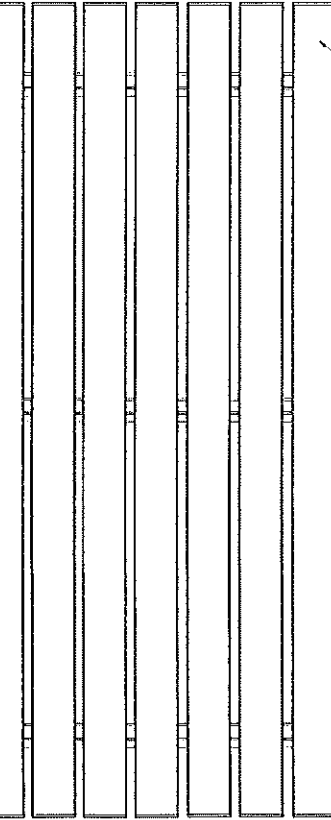
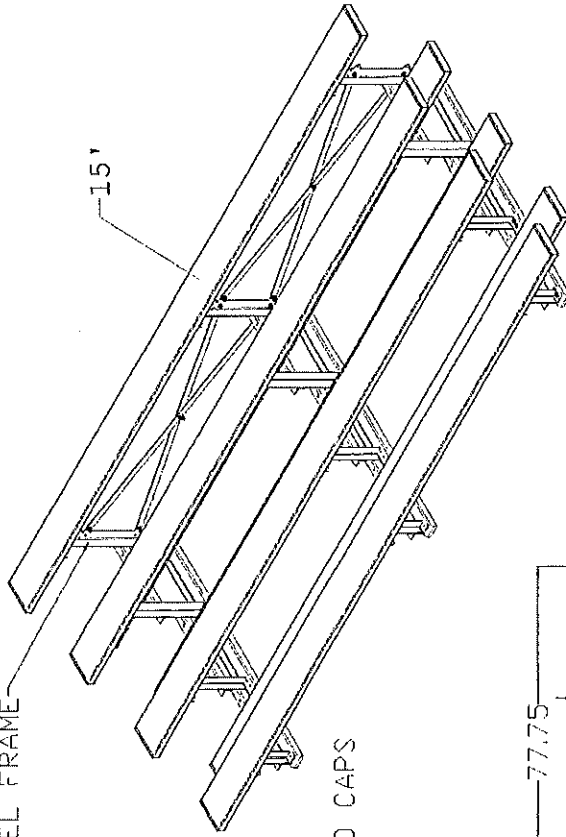

9.5" WIDE CLEAR ANODIZED ALUMINUM PLANKS

ALUMINUM END CAPS

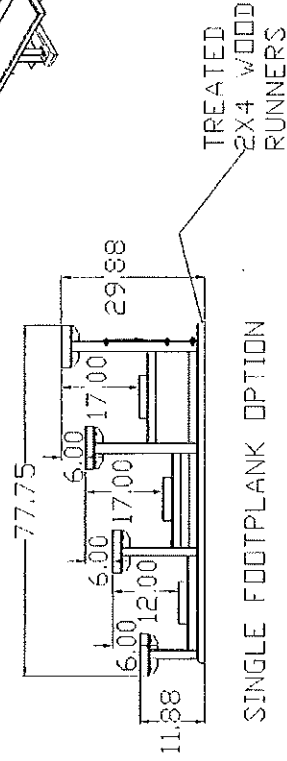
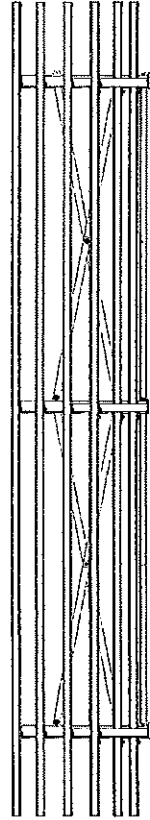

CUSTOM COLORED PLANKS AVAILABLE UPON
REQUEST FOR AN ADDITIONAL CHARGE

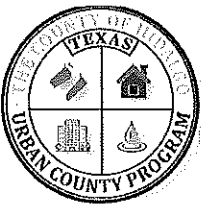

URBAN COUNTY PROGRAM

1916 TESORO ST. • PHARR, TEXAS 78577 • (956) 787-8127 FAX (956) 318-2988 •E-MAIL: ucp@co.hidalgo.tx.us

REQUEST FOR QUOTE

Hidalgo County Urban County Program is requesting a quote for the procurement of Park Equipment for the City of Penitas 2023 Parks and Recreational Facilities Improvements Project.

All quotes must contain a price and terms of a delivery date with a validity period of at least forty five (45) days. If you are unable to provide us with a quote please indicate so in writing.

All questions or discussions on this request for quotation must be directed to: **Eloisa Peña**

All quotes must be submitted no later than Monday December 9, 2024 by 3:00 pm

Contact: Eloisa Peña	Phone: (956) 787-8127 x2235 Email: eloisa.pena@co.hidalgo.tx.us		
Description	Qty	Unit Price	Extended Price
4 Row Bleachers	6	\$3,099.00	\$18,594.00
Shipping/Freight	1	\$4,995.00	\$4,995.00
Total			\$23,589.00

Note: Notice of tax exempt (if selected) tax exempt form shall be provided.

Luis E. Montemayor
Representative Name

12/04/2024
Date

luismontemayor@playrgvllc.com
Email Address

956-735-6212
Phone

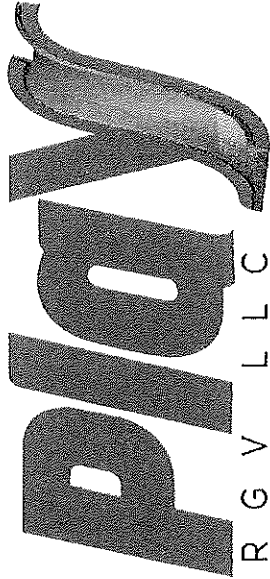

Project: URBAN County City of Peñitas
 RFP for 4 Row Aluminum Bleachers
 Scope: 4 Row Aluminum Bleachers

Sales Quote 11272024

URBAN County City of Peñitas
 1808 E. Expressway 83.
 Penitas, TX. 78576

824 E. Expressway 83 La Joya TX 78560

Quote Valid From: 11/27-12/31/2024

ITEM DESCRIPTION	QTY	UNIT PRICE	TOTAL PRICE
Commercial Playground Equipment			
4 Row Aluminum Bleachers - Low Rise Series	6	\$3,099.00	\$18,594.00
		Total Equip.	\$18,594.00
*Tax exempt certificate required at time of order, otherwise sales tax will be added.			
TAX		Tax Exempt	
		Subtotal	\$18,594.00
Freight	1	\$4,995.00	\$4,995.00
SUBTOTAL:			\$23,589.00

Contact Info: Luis E. Montemayor 956-735-6212 luisemontemayor@playrgvllc.com www.playrgvllc.com

Please mail check to the following address: PLAY RGV LLC P.O. Box 2003 La Joya, TX. 78560

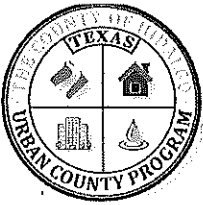

URBAN COUNTY PROGRAM

1916 TESORO ST. • PHARR, TEXAS 78577 • (956) 787-8127 FAX (956) 318-2988 •E-MAIL: ucp@co.hidalgo.tx.us

REQUEST FOR QUOTE

Hidalgo County Urban County Program is requesting a quote for the procurement of Park Equipment for the City of Penitas 2023 Parks and Recreational Facilities Improvements Project.

All quotes must contain a price and terms of a delivery date with a validity period of at least forty five (45) days. If you are unable to provide us with a quote please indicate so in writing.

All questions or discussions on this request for quotation must be directed to: **Eloisa Peña**

All quotes must be submitted no later than Monday December 9, 2024 by 3:00 pm

Contact: Eloisa Peña	Phone: (956) 787-8127 x2235 Email: eloisa.pena@co.hidalgo.tx.us		
Description	Qty	Unit Price	Extended Price
4 Row Bleachers	6	4,595.00	\$27,570.00
Shipping/Freight	1	2,438.82	\$2,438.82
Total			\$30,008.82

Note: Notice of tax exempt (if selected) tax exempt form shall be provided.

Vickie Nitto
Representative Name

12/04/2024
Date

Vickie.nitto@belson.com
Email Address

800-323-5664
Phone

Quote #
WQ 372451

Here is the Quote as per your request. The 'Shipping' total has been applied.
To place an order, simply click 'Submit Order Confirmation' below.
Please print this page for your records.
Customer Order Confirmation is **required** to process order.



627 Amersale Drive
Naperville, IL. 60563
sales@belson.com

Toll Free: 1-800-323-5664
Phone: 1-630-897-8489
Fax: 1-630-897-0573

QUOTE #
WQ 372451

Expires 11/29/2024

Model #	Description	Lbs	Quantity	Unit Price	Unit Total
BS-0415C	Bleacher, 4 Row x 15'-0"L, (10" Nominal Seat Planks, 10" Nominal Tread Planks, 17" Front Row Seat Height, 8" Rise, 24" Tread), Aluminum Frame, Single Footboards On Rows 2 & 3, Double Footboards & Riser On Row 4 & Higher, Chain-Link Guardrail **DISCOUNT APPLIED**	566	6	\$4,595.00	\$27,570.00
Subtotal				3,396	\$27,570.00
				0.0000% Tax	\$0.00
Customer Order Confirmation is required to process order.				Freight - S&H	\$2,438.82
Your Order will not be shipped without your "Order Confirmation"				Grand Total	\$30,008.82

First/Last Name Lupita Garcia

Company GG4 Consulting

Address 1 451 W Nolana Loop

Address 2 Ste 7

City Pharr

State TX

Zip Code 78577

Country USA

Phone 956-223-4312

Fax

Email lupita@gg4consulting.com

Ship To GG4 Consulting

Address 1 1111 S Main St

Address 2

City Penitas

State TX

Zip Code 78576

Country USA

Phone 956-223-4312

Contact Lupita Garcia

Email lupita@gg4consulting.com

Phone Call 24 Hours Prior to Delivery◇

Delivery to Residential or Non-Commercial Truck Route Addresses

Power Liftgate Service◇ - Driver will lower shipment from the truck to the ground (Only)

Order Power Liftgate Service *if* — You will be unable to unload the shipment from the truck.

◇ Does Not apply to UPS shipments

VN E HIDALGO COUNTY URBAN COUNTY PROGRAM

Accepted Payment Methods

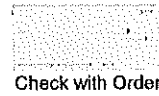

Customer Confirmation is Required to Complete Order

Email Order Confirmation

lupita@gg4consulting.com

Fax Order Confirmation

Customer Service Representative Call (M-F 8:00am - 4:30pm CST)

What is the best day and time to call?

Contact Name (If Different than 'Sold To')

Phone

[Submit Order Confirmation](#)

[Cancel Order](#)