



**Planning  
Department**

**Anthony Uresti**  
*Director of Planning*

**Main Office**

2818 S. Business Hwy 281  
Edinburg, Texas 78539  
Phone (956) 318-2840

**Precinct No. 1 Substation**

1900 Joe Stephens Ave. Ste. A  
Weslaco, TX 78596  
Phone (956) 968-4734

**Precinct No. 3 Substation**

2401 N. Moorefield Road  
Mission, Texas 78572  
Phone (956) 205-7045

**PIPELINE AND UTILITY PERMIT APPLICATION PACKET**

THE STATE OF TEXAS

COUNTY OF HIDALGO

PRECINCT 3

**APPLICATION AND AGREEMENT FOR PIPELINE OR  
UTILITY PERMIT**

Date: 7/25/2025

Vexus Fiber EDBG.06.004-3 (hereinafter referred to as "Applicant") does hereby make application to the Hidalgo County through the Hidalgo County Planning Department (hereinafter referred to as "HCPD") to construct, maintain and repair pipelines or utilities across the easements, right-of-ways, property or property interest as described below.

Information required:

1. Name, Address and Phone number of Applicant:

JJ Gonzalez - 5601 S Ware Rd, McAllen, TX

956-240-9625 - JJ.gonzalez@metronet.com

2. Name, Address and Phone number of company or agency owning Pipeline or Utility (please indicate if same as Applicant):

JJ Gonzalez - 5601 S Ware Rd, McAllen, TX

956-240-9625 - JJ.gonzalez@metronet.com

3. Name, Address and Phone number of operator of Pipeline or Utility (please indicate if same as Applicant):

JJ Gonzalez - 5601 S Ware Rd, McAllen, TX

956-240-9625 - JJ.gonzalez@metronet.com

4. Name, Address and Phone number of contractor to install Pipeline or Utility:

BST 1310 Industrial Way, Harlingen TX., 78550

Cody Fisher 956-367-4112

Visit Hidalgo County Planning Department on the web at [www.co.hidalgo.tx.us](http://www.co.hidalgo.tx.us)



## Planning Department

**Anthony Uresti**  
Director of Planning

### Main Office

2818 S. Business Hwy 281  
Edinburg, Texas 78539  
Phone (956) 318-2840

### Precinct No. 1 Substation

1900 Joe Stephens Ave. Ste. A  
Weslaco, TX 78596  
Phone (956) 968-4734

### Precinct No. 3 Substation

2401 N. Moorefield Road  
Mission, Texas 78572  
Phone (956) 205-7045

## PIPELINE AND UTILITY PERMIT APPLICATION PACKET

5. Is this a common carrier pipeline or utility? If yes, please submit the Applicant's Texas Railroad Commission Form "T-4" or similar form designating the facility:

No

---

---

---

6. Does Applicant have the Power of Eminent Domain?

No

---

---

7. Will the product be carried for hire or by the owner of the goods?

N/A

---

---

8. Name and Legal description of property owner requesting utility services if applicable:

N/A

---

---

9. Type of utility work within county road right-of-way:

Bore Crossing     Line Extension Along R.O.W.     Other \_\_\_\_\_

10. Where is the origin of the line?

N/A

---

---

11. Where is the destination of the line?

N/A

---

---



## Planning Department

**Anthony Uresti**  
Director of Planning

### Main Office

2818 S. Business Hwy 281  
Edinburg, Texas 78539  
Phone (956) 318-2840

### Precinct No. 1 Substation

1900 Joe Stephens Ave. Ste. A  
Weslaco, TX 78596  
Phone (956) 968-4734

### Precinct No. 3 Substation

2401 N. Moorefield Road  
Mission, Texas 78572  
Phone (956) 205-7045

## PIPELINE AND UTILITY PERMIT APPLICATION PACKET

12. Utility Crossing Coordinate X: 26.304487 Y: -98.261951  
(NAD 83 Texas South FIPS 4205 feet)
13. Number and size of lines:  
Placing 2" HDPE PIPE BY DIRECTIONAL BORE METHOD AND  
PULLING FIBER IN THE DUCT
14. Pressure (each line):  
N/A
15. Content (each line):  
N/A
16. Estimated date of installation of Pipeline or Utility:  
As soon as this permit gets approved by H.C Commissioner Court

Sheet 1: 26.304487, -98.261951

Sheet 3: 26.30142, -98.247786

Sheet 4: 26.299489, -98.254006

Sheet 5: 26.299528, -98.247186

Sheet 6: 26.296414, -98.274167

Sheet 10: 26.297189, -98.256302

Sheet 12: 26.29707, -98.249516

Sheet 13: 26.296865, -98.247424

Sheet 20: 26.294645, -98.257306

Sheet 22: 26.295167, -98.245938

Sheet 25: 26.2926, -98.24673

Sheet 27: 26.290334, -98.264169

Sheet 28: 26.289002, -98.251418

Sheet 30: 26.288662, -98.262105

Sheet 35: 26.281546, -98.270422

Sheet 36: 26.278939, -98.273664



## Planning Department

**Anthony Uresti**  
*Director of Planning*

### Main Office

2818 S. Business Hwy 281  
Edinburg, Texas 78539  
Phone (956) 318-2840

### Precinct No. 1 Substation

1900 Joe Stephens Ave. Ste. A  
Weslaco, TX 78596  
Phone (956) 968-4734

### Precinct No. 3 Substation

2401 N. Moorefield Road  
Mission, Texas 78572  
Phone (956) 205-7045

## PIPELINE AND UTILITY PERMIT APPLICATION PACKET

If requested permit is granted by HCPD, Applicant, in consideration thereof, agrees and binds itself as follows:

1. All pipelines or utilities herein will be horizontally placed within the right-of-way as determined by HCPD and at a minimum depth of five (5) feet below natural ground. Depth, horizontal, and vertical location shall be confirmed by HCPD Inspectors.
2. Location map, profile, and plans concerning the proposed pipeline or utility crossing will furnished with this application.
3. HCPD will be notified in writing ten days prior to the beginning date of construction under this permit.
4. Applicant will bear the entire expense of all future relocations of any pipelines or utilities should such relocation, at the sole discretion of the Hidalgo County Commissioners Court, be necessary for improvements, alteration, or maintenance of Hidalgo County's easement or property of interest.
5. Applicant will notify the HCPD at least 48 hours prior to covering work and or completion of its work and removal of its equipment from the job site to permit HCPD to make an inspection.
6. Upon notification by the HCPD, the Applicant will promptly repair or rectify any deficiency or condition caused by the Applicant's operations or installations under this permit. Applicant will leave easement in as near the same condition or better, in the HCPD's sole judgment, as it existed prior to the commencement of the operations under this permit.
7. Hidalgo County shall not be liable or responsible for, and shall be saved and held harmless by Applicant, and further shall be indemnified by Applicant, from and against any and all suits, actions, losses, damages, claims, or liability of any character, type, or description, including all expenses of litigation, court costs, attorney's fees, and engineering fees for injury or death to any person, or injury to any property, received or sustained by any person or persons or property, arising out of, or occasioned by, directly or indirectly, the performance of Applicant under this agreement, including claims and damages arising in part from the negligence of Hidalgo County.



## Planning Department

**Anthony Uresti**  
*Director of Planning*

### Main Office

2818 S. Business Hwy 281  
Edinburg, Texas 78539  
Phone (956) 318-2840

### Precinct No. 1 Substation

1900 Joe Stephens Ave. Ste. A  
Weslaco, TX 78596  
Phone (956) 968-4734

### Precinct No. 3 Substation

2401 N. Moorefield Road  
Mission, Texas 78572  
Phone (956) 205-7045

## PIPELINE AND UTILITY PERMIT APPLICATION PACKET

It is the expressed intent of the parties to this agreement that the indemnity provided for in this section is extended by Applicant to indemnify and protect Hidalgo County from the consequences of Hidalgo County's own negligence, whether that negligence is the sole or contributory cause of the resultant injury death, or damage.

Applicant further agrees to defend, at its own expense, with attorneys acceptable to Hidalgo County and on behalf of Hidalgo County, and in the name of Hidalgo County, any claim or litigation brought against Hidalgo County in connection with any such injury, death or damage.

Before construction is begun on such pipeline or utility crossings, Applicant will furnish to the HCPD a certificate of insurance (or other security approved by the HCPD) payable to Hidalgo County and protecting Hidalgo County (as an additional named insured) against any claims for personal injuries or damages to property resulting from the operations of Applicant, its agents, servants, employees, and contractors under this permit. Insurance is to be supplied in accordance with the attached Schedule A.

8. Hidalgo County makes no warranties, expressed or implied, in the granting of this permit; nor does Hidalgo County purport to grant any property interest or exclusive privileges whatsoever by granting such permit. It is specifically understood that Hidalgo County is not the agent for, nor does it act for, the fee owners or any persons or entities having any right, or title to possession of the land upon which Hidalgo County's easement or other property interest is located. Furthermore, in granting this permit Hidalgo County makes no representation or warranty that it has any property interest, including, but not limited to, an easement or right of way, in the land upon which Applicant constructs, maintains, repairs, or modifies the pipelines or utilities, made the subject of this application, nor does Hidalgo County make any representation or warranty as to the validity, quality or extent of such property interest, if any. Applicant acknowledges its understanding that Hidalgo County in granting this permit, does not convey or grant to Applicant any rights, title or interest for which is has no legal authority to grant or convey.
9. Applicant binds itself to comply with all federal, state, and local laws or regulations and will obtain all necessary permits from all local and federal agencies required by law before installation or construction is begun.



## Planning Department

**Anthony Uresti**  
*Director of Planning*

### Main Office

2818 S. Business Hwy 281  
Edinburg, Texas 78539  
Phone (956) 318-2840

### Precinct No. 1 Substation

1900 Joe Stephens Ave. Ste. A  
Weslaco, TX 78596  
Phone (956) 968-4734

### Precinct No. 3 Substation

2401 N. Moorefield Road  
Mission, Texas 78572  
Phone (956) 205-7045

## PIPELINE AND UTILITY PERMIT APPLICATION PACKET

10. Applicant will install its pipelines and utilities in a manner and location as shown in the plans and specifications filed with HCPD in support of this application for permit. Hidalgo County Planning Department's representative may at any time make such inspection as such engineer or other representation may deem necessary to assure that the construction of the pipeline or utilities is in accordance with the plans and specifications submitted, and said engineer or representative shall have the right to temporarily suspend Applicant's work if necessary, while such inspection is being made. Should Applicant not install the pipelines or utilities in accordance with the terms and conditions of this permit, Applicant agrees that Hidalgo County shall have the right to require, at Applicant's expense, the removal of the pipelines and utilities and its replacement in conformance to said plans and specifications and conditions of this permit. Hidalgo County may revoke this permit and suspend all work hereunder if it is determined by Hidalgo County that the pipelines or utilities are not being installed in accordance with such plans and specifications and conditions of this permit. The suspension or revocation of this permit shall not be a basis for a claim for damages against Hidalgo County.
11. Except in emergency situations where it is necessary to protect life and property, Applicant will not make any change, modification, or alteration in or to the pipelines or utilities without first securing a new or amended permit from Hidalgo County prior to the making of any such change. Applicant will maintain the pipelines or utilities hereby authorized in good and safe condition, and in accordance with plans, specifications, and this permit.
12. Applicant agrees to pay HCPD a permit fee to cover administrative costs in the amount of **\$500.00**, plus a reimbursement to HCPD for any necessary engineering fees which may be incurred for the study and processing of the Application. This fee will permit a single pipeline or utility to be within County right-of-way. Applicant further agrees to pay an additional fee of **\$500.00** for each additional line included in permit application at the same location; however, more than one location may be included in a single application.

Requests to lay additional line or lines, not included in an initial permit application, must be made by separate application, with new permit fees paid accordingly and support data provided.



## Planning Department

**Anthony Uresti**  
*Director of Planning*

### Main Office

2818 S. Business Hwy 281  
Edinburg, Texas 78539  
Phone (956) 318-2840

### Precinct No. 1 Substation

1900 Joe Stephens Ave. Ste. A  
Weslaco, TX 78596  
Phone (956) 968-4734

### Precinct No. 3 Substation

2401 N. Moorefield Road  
Mission, Texas 78572  
Phone (956) 205-7045

## PIPELINE AND UTILITY PERMIT APPLICATION PACKET

Permit fees may be waived where Applicant is a state, county, municipality, or a special political subdivision.

13. The Applicant is allowed one hundred twenty days (120) from the granting of the permit to start construction of the pipelines or utilities crossings. Once started, the Applicant is allowed ninety (90) days to complete all work under such permit. All construction must be completed within two hundred ten (210) days from the date of issuance of permit. Upon application, extension of the time periods set forth in this paragraph may be granted by the Hidalgo County Commissioners Court. Such applications for extension must be received by HCPD at least thirty days before the expiration of the two hundred ten (210) days period. A new permit fee, in accordance with Paragraph 12 hereof, will be charged for each extension granted.

Construction of any pipeline or utility crossing will not begin until written approval has been given by HCPD.

14. All provisions of the Pipeline and Utility Permit Administration Policy of Hidalgo County, if any, and all amendments thereto, are hereby incorporated herein as part of the terms and conditions of this permit for all purposes.
15. Applicant warrants and represents that it has secured from all fee owners of the involved property an easement or other property rights to construct, repair or modify the pipeline or utility in the manner set forth herein.
16. This Pipeline and Utility Permit if granted by Hidalgo County is subject to any and all other requirements, specifications and conditions listed in Exhibit A attached hereto.
17. Hidalgo County requires all coordinates of all utility crossings. Horizontal datum to be in NAD 83 State Plane Texas South 4205 feet and vertical datum in NAVD 88 Geoid 12a.



**Planning  
Department**

**Anthony Uresti**  
Director of Planning

**Main Office**

2818 S. Business Hwy 281  
Edinburg, Texas 78539  
Phone (956) 318-2840  
Fax (956) 318-2844

**Precinct No. 1 Substation**

1900 Joe Stephens Ave. Ste. A  
Weslaco, TX 78596  
Phone (956) 968-4734  
Fax (956) 973-7850

**Precinct No. 3 Substation**

2401 N. Moorefield Road  
Mission, Texas 78572  
Phone (956) 205-7045  
Fax (956) 205-7049

**PIPELINE AND UTILITY PERMIT APPLICATION PACKET**

18. This permit constitutes the entire agreement between the parties with regard to the subject matter hereof, and all prior agreements, representations, and negotiations between the parties regarding the subject matter are hereby superseded. This permit shall not be altered or amended except by an agreement in writing executed by the parties hereto.

19. Applicant warrants and represents that its undersigned representative has full authority to bind Applicant to the terms and conditions of the foregoing Application and Agreement for Pipeline or Utility Permit.

DATED this 22<sup>nd</sup> day of May, 2025.

Luis Smith  
(Name of Applicant – Printed or Typed)

By: [Signature]  
Signature

Title: Sr. Permit Coordinator

STATE OF TEXAS  
COUNTY OF HIDALGO

SUBSCRIBED AND SWORN TO before me the Applicant,  
Luis Smith, on this 22 day of May, 2025,  
to which witness my hand and seal of office.

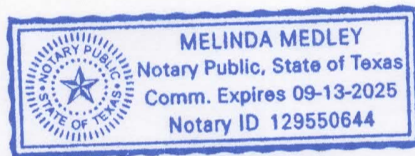

Melinda Medley  
Notary Public for the State of Texas

My Commission Expires: 9-13-2025



**Planning  
Department**

**Anthony Uresti**  
Director of Planning

**Main Office**

2818 S. Business Hwy 281  
Edinburg, Texas 78539  
Phone (956) 318-2840

**Precinct No. 1 Substation**

1900 Joe Stephens Ave. Ste. A  
Weslaco, TX 78596  
Phone (956) 968-4734

**Precinct No. 3 Substation**

2401 N. Moorefield Road  
Mission, Texas 78572  
Phone (956) 205-7045

**PIPELINE AND UTILITY PERMIT APPLICATION PACKET**

18. This permit constitutes the entire agreement between the parties with regard to the subject matter hereof, and all prior agreements, representations, and negotiations between the parties regarding the subject matter are hereby superseded. This permit shall not be altered or amended except by an agreement in writing executed by the parties hereto.
19. Applicant warrants and represents that its undersigned representative has full authority to bind Applicant to the terms and conditions of the foregoing Application and Agreement for Pipeline or Utility Permit.

DATED this September day of 2<sup>nd</sup>, 2025.

Tiffany Rice

(Name of Applicant – Printed or Typed)

By: [Signature]

Signature

Title: Permitting Manager

STATE OF TEXAS  
COUNTY OF HIDALGO

SUBSCRIBED AND SWORN TO before me the Applicant,  
Tiffany Rice, on this 2 day of Sept., 2025  
to which witness my hand and seal of office.

[Signature]

Notary Public for the State of Texas

My Commission Expires: 12/3/2025





**Planning  
Department**

**Anthony Uresti**  
*Director of Planning*

**Main Office**

2818 S. Business Hwy 281  
Edinburg, Texas 78539  
Phone (956) 318-2840

**Precinct No. 1 Substation**

1900 Joe Stephens Ave. Ste. A  
Weslaco, TX 78596  
Phone (956) 968-4734

**Precinct No. 3 Substation**

2401 N. Moorefield Road  
Mission, Texas 78572  
Phone (956) 205-7045

**PIPELINE AND UTILITY PERMIT APPLICATION PACKET**

**APPROVAL OF APPLICATION BY  
HIDALGO COUNTY PLANNING DEPARTMENT**

Came on for consideration this \_\_\_\_\_ day of \_\_\_\_\_,  
20\_\_\_\_. The above and foregoing Application for Pipeline and Utility  
Permit, and after consideration of the same by the Hidalgo County  
Commissioners Court, said Application and Agreement for Pipeline or  
Utility Permit is hereby APPROVED.

HIDALGO COUNTY:

\_\_\_\_\_  
Richard F. Cortez, County Judge



## Planning Department

**Anthony Uresti**  
*Director of Planning*

### **Main Office**

2818 S. Business Hwy 281  
Edinburg, Texas 78539  
Phone (956) 318-2840

### **Precinct No. 1 Substation**

1900 Joe Stephens Ave. Ste. A  
Weslaco, TX 78596  
Phone (956) 968-4734

### **Precinct No. 3 Substation**

2401 N. Moorefield Road  
Mission, Texas 78572  
Phone (956) 205-7045

# **PIPELINE AND UTILITY PERMIT APPLICATION PACKET**

## **EXHIBIT A**

(Please insert description of project location and supporting documents for proposed utility work)



# CERTIFICATE OF LIABILITY INSURANCE

DATE (MM/DD/YYYY)

7/9/2025

THIS CERTIFICATE IS ISSUED AS A MATTER OF INFORMATION ONLY AND CONFERS NO RIGHTS UPON THE CERTIFICATE HOLDER. THIS CERTIFICATE DOES NOT AFFIRMATIVELY OR NEGATIVELY AMEND, EXTEND OR ALTER THE COVERAGE AFFORDED BY THE POLICIES BELOW. THIS CERTIFICATE OF INSURANCE DOES NOT CONSTITUTE A CONTRACT BETWEEN THE ISSUING INSURER(S), AUTHORIZED REPRESENTATIVE OR PRODUCER, AND THE CERTIFICATE HOLDER.

**IMPORTANT:** If the certificate holder is an ADDITIONAL INSURED, the policy(ies) must have ADDITIONAL INSURED provisions or be endorsed. If SUBROGATION IS WAIVED, subject to the terms and conditions of the policy, certain policies may require an endorsement. A statement on this certificate does not confer rights to the certificate holder in lieu of such endorsement(s).

<b>PRODUCER</b> IMA, Inc. - Kansas City 11350 Switzer Rd, Suite 200 Overland Park KS 66210	<b>CONTACT NAME:</b> Erika Flynn <b>PHONE (A/C, No, Ext):</b> 913-800-2397 <b>E-MAIL ADDRESS:</b> erika.flynn@imacorp.com	<b>FAX (A/C, No):</b>
	<b>INSURER(S) AFFORDING COVERAGE</b>	
License#: PC-1210733 METRINC-01	<b>INSURER A:</b> The Standard Fire Insurance Company <b>INSURER B:</b> The Charter Oak Fire Insurance Company <b>INSURER C:</b> The Travelers Indemnity Company of America <b>INSURER D:</b> Travelers Property Casualty Company of America <b>INSURER E:</b> Endurance American Specialty Insurance Company <b>INSURER F:</b>	<b>NAIC #</b> 19070 25615 25666 25674 41718

**COVERAGES** **CERTIFICATE NUMBER:** 2115361831 **REVISION NUMBER:**

THIS IS TO CERTIFY THAT THE POLICIES OF INSURANCE LISTED BELOW HAVE BEEN ISSUED TO THE INSURED NAMED ABOVE FOR THE POLICY PERIOD INDICATED. NOTWITHSTANDING ANY REQUIREMENT, TERM OR CONDITION OF ANY CONTRACT OR OTHER DOCUMENT WITH RESPECT TO WHICH THIS CERTIFICATE MAY BE ISSUED OR MAY PERTAIN, THE INSURANCE AFFORDED BY THE POLICIES DESCRIBED HEREIN IS SUBJECT TO ALL THE TERMS, EXCLUSIONS AND CONDITIONS OF SUCH POLICIES. LIMITS SHOWN MAY HAVE BEEN REDUCED BY PAID CLAIMS.

INSR LTR	TYPE OF INSURANCE	ADDL INSD	SUBR WVD	POLICY NUMBER	POLICY EFF (MM/DD/YYYY)	POLICY EXP (MM/DD/YYYY)	LIMITS
B	<input checked="" type="checkbox"/> <b>COMMERCIAL GENERAL LIABILITY</b> <input type="checkbox"/> CLAIMS-MADE <input checked="" type="checkbox"/> OCCUR GEN'L AGGREGATE LIMIT APPLIES PER: <input checked="" type="checkbox"/> POLICY <input type="checkbox"/> PRO-JECT <input type="checkbox"/> LOC OTHER:			6309P532424COF24	10/1/2024	10/1/2025	EACH OCCURRENCE \$ 1,000,000 DAMAGE TO RENTED PREMISES (Ea occurrence) \$ 1,000,000 MED EXP (Any one person) \$ 10,000 PERSONAL & ADV INJURY \$ 1,000,000 GENERAL AGGREGATE \$ 2,000,000 PRODUCTS - COMP/OP AGG \$ 2,000,000 \$
C	<input checked="" type="checkbox"/> <b>AUTOMOBILE LIABILITY</b> <input checked="" type="checkbox"/> ANY AUTO <input type="checkbox"/> OWNED AUTOS ONLY <input type="checkbox"/> SCHEDULED AUTOS <input type="checkbox"/> HIRED AUTOS ONLY <input type="checkbox"/> NON-OWNED AUTOS ONLY			CAP9P532412TIL24	10/1/2024	10/1/2025	COMBINED SINGLE LIMIT (Ea accident) \$ 1,000,000 BODILY INJURY (Per person) \$ BODILY INJURY (Per accident) \$ PROPERTY DAMAGE (Per accident) \$ \$
D	<input checked="" type="checkbox"/> <b>UMBRELLA LIAB</b> <input checked="" type="checkbox"/> OCCUR <input type="checkbox"/> EXCESS LIAB <input type="checkbox"/> CLAIMS-MADE <input type="checkbox"/> DED <input checked="" type="checkbox"/> RETENTION \$ 10,000			CUP9P53243624I3	10/1/2024	10/1/2025	EACH OCCURRENCE \$ 4,000,000 AGGREGATE \$ 4,000,000 \$
A	<input checked="" type="checkbox"/> <b>WORKERS COMPENSATION AND EMPLOYERS' LIABILITY</b> ANY PROPRIETOR/PARTNER/EXECUTIVE OFFICER/MEMBER EXCLUDED? (Mandatory in NH) If yes, describe under DESCRIPTION OF OPERATIONS below	Y/N N	N/A	UB3Y56457324I3K	10/1/2024	10/1/2025	<input checked="" type="checkbox"/> PER STATUTE <input type="checkbox"/> OTHER E.L. EACH ACCIDENT \$ 1,000,000 E.L. DISEASE - EA EMPLOYEE \$ 1,000,000 E.L. DISEASE - POLICY LIMIT \$ 1,000,000
B E	Leased/Rented Coverage Cyber Liability			6309P532424COF24 CTO30069533500	10/1/2024 10/1/2024	10/1/2025 10/1/2025	Limit \$1,000,000 See Below Deductible \$50,000

**DESCRIPTION OF OPERATIONS / LOCATIONS / VEHICLES (ACORD 101, Additional Remarks Schedule, may be attached if more space is required)**  
 Cyber Liability: Each Occurrence \$10,000,000; Aggregate \$10,000,000; Retention \$100,000.  
 The General Liability policy includes a Contractual Liability Railroad endorsement CG D6 47 10 12, subject to policy terms and conditions.  
 Certificate Holder and all other parties required by the contract are included as Additional Insured on the General Liability, Automobile Liability and Umbrella Liability Policies, if required by written contract or agreement, subject to the policy terms and conditions.

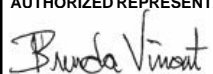
<b>CERTIFICATE HOLDER</b>  Hidalgo County 2818 S Business Hwy 281 Edinburg TX 78539	<b>CANCELLATION</b>  SHOULD ANY OF THE ABOVE DESCRIBED POLICIES BE CANCELLED BEFORE THE EXPIRATION DATE THEREOF, NOTICE WILL BE DELIVERED IN ACCORDANCE WITH THE POLICY PROVISIONS.  AUTHORIZED REPRESENTATIVE 
---	--

© 1988-2015 ACORD CORPORATION. All rights reserved.



## Planning Department

**Anthony Uresti**  
*Director of Planning*

### Main Office

2818 S. Business Hwy 281  
Edinburg, Texas 78539  
Phone (956) 318-2840  
Fax (956) 318-2844

### Precinct No. 1 Substation

1900 Joe Stephens Ave. Ste. A  
Weslaco, TX 78596  
Phone (956) 968-4734  
Fax (956) 973-7850

### Precinct No. 3 Substation

2401 N. Moorefield Road  
Mission, Texas 78572  
Phone (956) 205-7045  
Fax (956) 205-7049

# PIPELINE AND UTILITY PERMIT APPLICATION PACKET

## EXHIBIT A

(Please insert description of project location and supporting documents for proposed utility work)

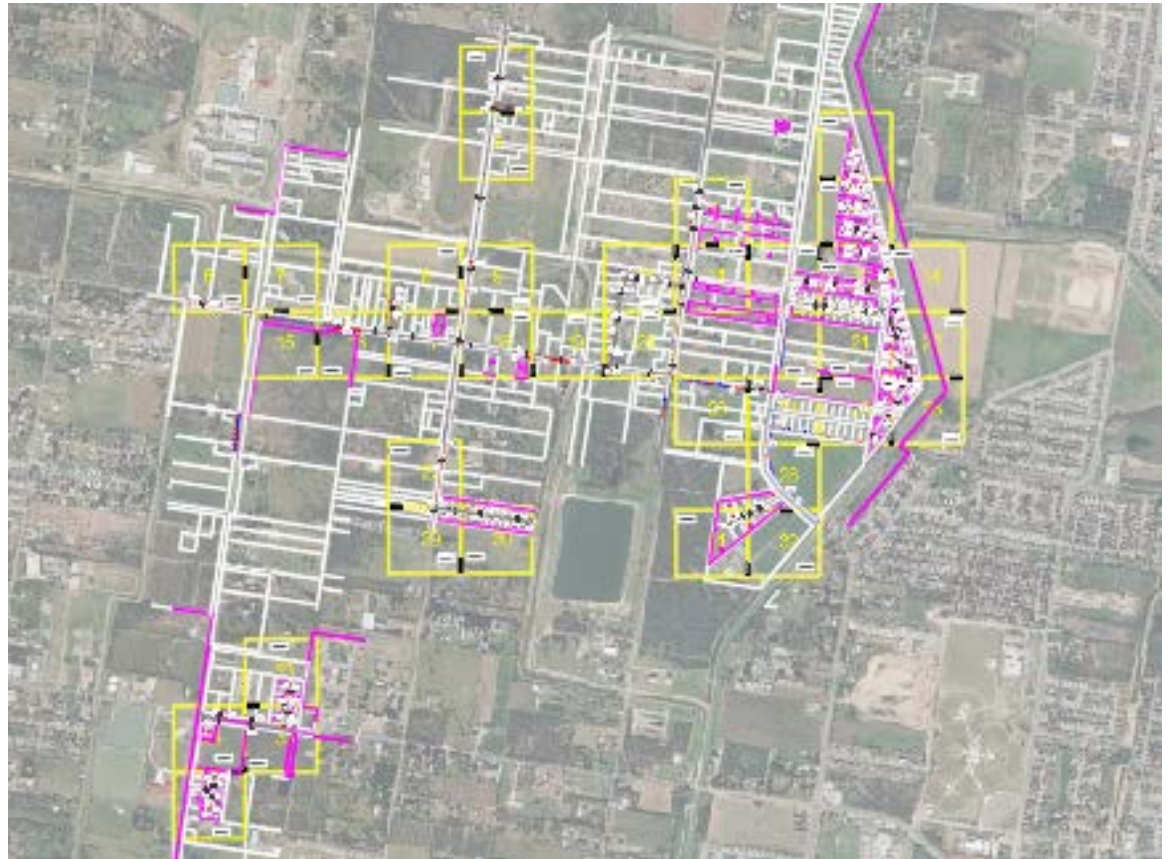

# EDBG.06.004.PERMIT.UG.HIDALGO\_NO RISERS.dwg

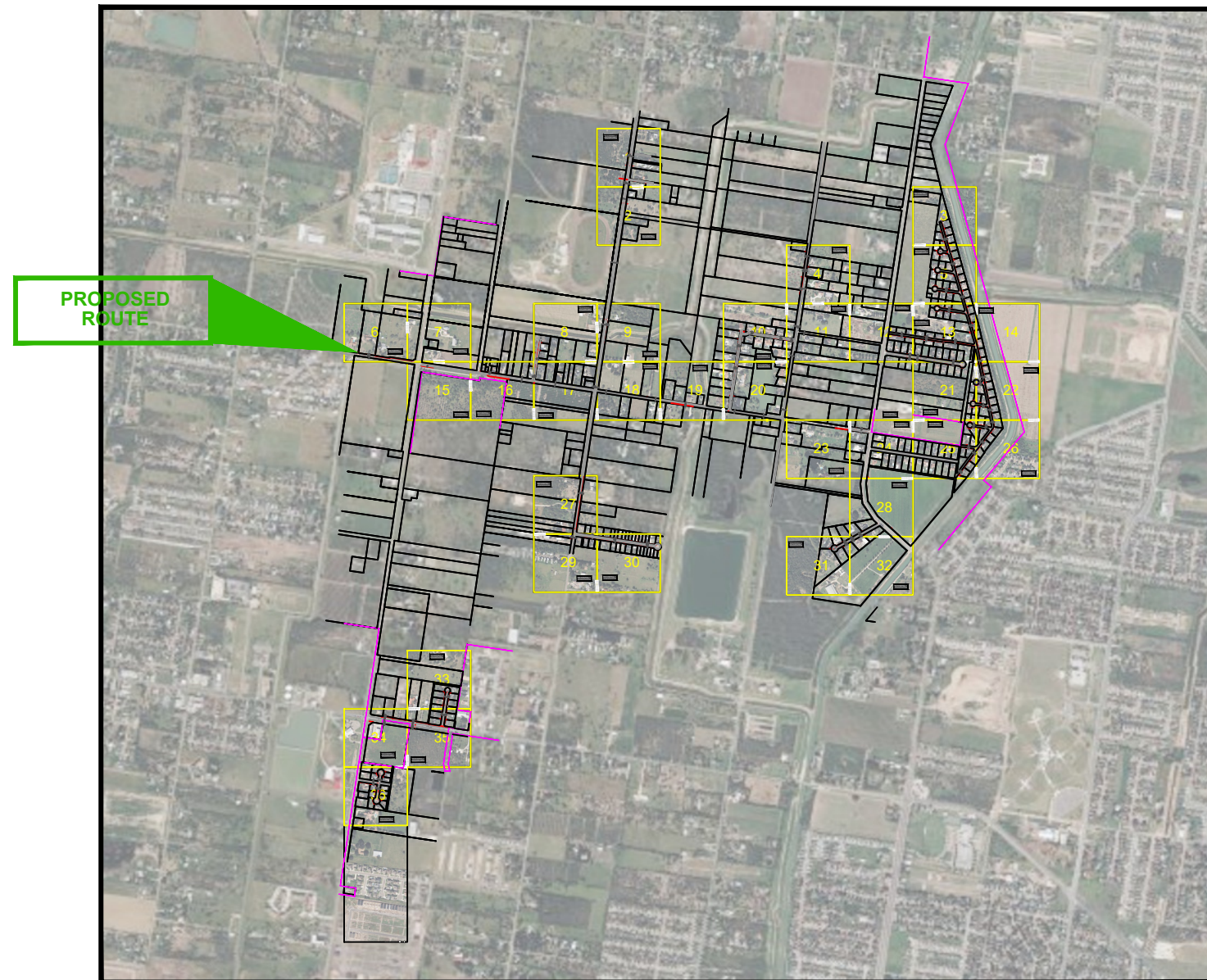

TOTAL LINEAR FOOTAGE: 33,139 FT

## NOTES:

1. PROPOSED FIBER OPTIC DESIGN IS BASED ON AUTOCAD MAP3D GEO MAPPING.
2. PROPERTY LINES ARE SHOWN FOR REFERENCE ONLY. CONSTRUCTION CONTRACTOR SHALL VERIFY THE ROAD RIGHT-OF-WAY AND EASEMENT PRIOR TO COMMENCING WORK. NO FACILITIES SHOULD BE PLACED ON PRIVATE PROPERTY WITHOUT PRIOR APPROVAL.
3. CONSTRUCTION CONTRACTOR IS RESPONSIBLE FOR VERIFICATION OF ALL DIMENSIONS, QUANTITIES, AND EXISTING CONDITIONS PRIOR TO CONSTRUCTION.
4. ACTUAL LOCATION OF EXISTING UTILITIES TO BE DETERMINED IN THE FIELD AT THE TIME OF CONSTRUCTION. THE CONSTRUCTION CONTRACTOR SHALL CONTACT ALL UTILITY COMPANIES PRIOR TO CONSTRUCTION. THE CONSTRUCTION CONTRACTOR SHALL PROTECT ALL UTILITIES AND SHALL BE RESPONSIBLE FOR ANY DAMAGE INCURRED DURING CONSTRUCTION AND SHALL REPAIR SAID DAMAGES AT THEIR EXPENSE. CALL 811 PRIOR TO CONSTRUCTION FOR UNDERGROUND UTILITY LOCATIONS
5. ALL PROPOSED DIRECTIONAL BORINGS SHALL BE WITHIN THE RIGHT-OF-WAY AT A MINIMUM DISTANCE OF 2' FROM THE BACK OF CURB AND WITH A MINIMUM DEPTH OF 36" UNLESS OTHERWISE NOTED. KEEP A MINIMUM DISTANCE OF 1' TO 2' FROM EXISTING UNDERGROUND UTILITIES.
6. FOR NIGHTS AND WEEKENDS, ANY EXCAVATED AREAS SUCH AS BORE PITS, FLOWER POTS, AND HAND HOLES NEEDS TO BE PROPERLY COVERED OR FENCED OFF. NO EXPOSED AREAS.
7. ALLEY CONSTRUCTION WILL BE PERFORMED BY CLOSING ALLEY WHILE CONSTRUCTION OCCURS WITH PROPER BARRICADES AND SIGNAGE.

BORE @ A MIN DEPTH OF 36", 1-2' AWAY FROM ANY EXISTING UG UTILITIES

Lat: 26.304487  
Long: -98.261951

Legend













	Active Cabinet		Passive Cabinet
	Pole		Handhole
	Parcel		Pedestal
	Flower Pot		Aerial Length
	Buried Length		Aerial Fiber
	Buried Fiber		
	Strand		

- NOTES:
1. PROPOSED FIBER OPTIC DESIGN IS BASED ON AUTOCAD MAP3D GEO MAPPING.
  2. PROPERTY LINES ARE SHOWN FOR REFERENCE ONLY. CONSTRUCTION CONTRACTOR SHALL VERIFY THE ROAD RIGHT-OF-WAY AND EASEMENT PRIOR TO COMMENCING WORK. NO FACILITIES SHOULD BE PLACED ON PRIVATE PROPERTY WITHOUT PRIOR APPROVAL.
  3. CONSTRUCTION CONTRACTOR IS RESPONSIBLE FOR VERIFICATION OF ALL DIMENSIONS, QUANTITIES, AND EXISTING CONDITIONS PRIOR TO CONSTRUCTION.
  4. ACTUAL LOCATION OF EXISTING UTILITIES TO BE DETERMINED IN THE FIELD AT THE TIME OF CONSTRUCTION. THE CONSTRUCTION CONTRACTOR SHALL CONTACT ALL UTILITY COMPANIES PRIOR TO CONSTRUCTION. THE CONSTRUCTION CONTRACTOR SHALL PROTECT ALL UTILITIES AND SHALL BE RESPONSIBLE FOR ANY DAMAGE INCURRED DURING CONSTRUCTION AND SHALL REPAIR SAID DAMAGES AT THEIR EXPENSE. CALL 811 PRIOR TO CONSTRUCTION FOR UNDERGROUND UTILITY LOCATIONS
  5. ALL PROPOSED DIRECTIONAL BORINGS SHALL BE WITHIN THE RIGHT-OF-WAY AT A MINIMUM DISTANCE OF 2' FROM THE BACK OF CURB AND WITH A MINIMUM DEPTH OF 36" UNLESS OTHERWISE NOTED. KEEP A MINIMUM DISTANCE OF 1' TO 2' FROM EXISTING UNDERGROUND UTILITIES.
  6. FOR NIGHTS AND WEEKENDS, ANY EXCAVATED AREAS SUCH AS BORE PITS, FLOWER POTS, AND HAND HOLES NEEDS TO BE PROPERLY COVERED OR FENCED OFF. NO EXPOSED AREAS.
  7. ALLEY CONSTRUCTION WILL BE PERFORMED BY CLOSING ALLEY WHILE CONSTRUCTION OCCURS WITH PROPER BARRICADES AND SIGNAGE.

**Disclaimer: Utility and property lines are shown for reference only. It is the Contractor's responsibility to validate the information to ensure no underground utilities are damaged and installed infrastructure is within public right-of-way.**

MATCHLINE SHEET 2

Legend

 Active Cabinet	 Passive Cabinet
 Pole	 Handhole
 Parcel	 Pedestal
 Flower Pot	 Aerial Length
 Buried Length	 Aerial Fiber
 F/O_BUR Buried Fiber	 Strand

- NOTES:
1. PROPOSED FIBER OPTIC DESIGN IS BASED ON AUTOCAD MAP3D GEO MAPPING.
  2. PROPERTY LINES ARE SHOWN FOR REFERENCE ONLY. CONSTRUCTION CONTRACTOR SHALL VERIFY THE ROAD RIGHT-OF-WAY AND EASEMENT PRIOR TO COMMENCING WORK. NO FACILITIES SHOULD BE PLACED ON PRIVATE PROPERTY WITHOUT PRIOR APPROVAL.
  3. CONSTRUCTION CONTRACTOR IS RESPONSIBLE FOR VERIFICATION OF ALL DIMENSIONS, QUANTITIES, AND EXISTING CONDITIONS PRIOR TO CONSTRUCTION.
  4. ACTUAL LOCATION OF EXISTING UTILITIES TO BE DETERMINED IN THE FIELD AT THE TIME OF CONSTRUCTION. THE CONSTRUCTION CONTRACTOR SHALL CONTACT ALL UTILITY COMPANIES PRIOR TO CONSTRUCTION. THE CONSTRUCTION CONTRACTOR SHALL PROTECT ALL UTILITIES AND SHALL BE RESPONSIBLE FOR ANY DAMAGE INCURRED DURING CONSTRUCTION AND SHALL REPAIR SAID DAMAGES AT THEIR EXPENSE. CALL 811 PRIOR TO CONSTRUCTION FOR UNDERGROUND UTILITY LOCATIONS
  5. ALL PROPOSED DIRECTIONAL BORINGS SHALL BE WITHIN THE RIGHT-OF-WAY AT A MINIMUM DISTANCE OF 2' FROM THE BACK OF CURB AND WITH A MINIMUM DEPTH OF 36" UNLESS OTHERWISE NOTED. KEEP A MINIMUM DISTANCE OF 1' TO 2' FROM EXISTING UNDERGROUND UTILITIES.
  6. FOR NIGHTS AND WEEKENDS, ANY EXCAVATED AREAS SUCH AS BORE PITS, FLOWER POTS, AND HAND HOLES NEEDS TO BE PROPERLY COVERED OR FENCED OFF. NO EXPOSED AREAS.
  7. ALLEY CONSTRUCTION WILL BE PERFORMED BY CLOSING ALLEY WHILE CONSTRUCTION OCCURS WITH PROPER BARRICADES AND SIGNAGE.

**Disclaimer: Utility and property lines are shown for reference only. It is the Contractor's responsibility to validate the information to ensure no underground utilities are damaged and installed infrastructure is within public right-of-way.**

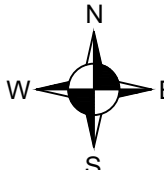
Page 3 of 45

**BORE @ A MIN DEPTH OF 36", 1-2' AWAY FROM ANY EXISTING UG UTILITIES**

**Lat: 26.30142  
Long: -98.247786**

**F POT**

**F POT**













**F POT**

**F POT**

**F POT**

BORE @ A MIN DEPTH OF 36", 1-2' AWAY FROM ANY EXISTING UG UTILITIES

Legend

-  Active Cabinet
-  Passive Cabinet
-  Pole
-  Handhole
-  Parcel
-  Pedestal
-  Flower Pot
-  Aerial Length
-  Buried Length
-  Aerial Fiber
-  Buried Fiber
-  Strand

NOTES:

1. PROPOSED FIBER OPTIC DESIGN IS BASED ON AUTOCAD MAP3D GEO MAPPING.
2. PROPERTY LINES ARE SHOWN FOR REFERENCE ONLY. CONSTRUCTION CONTRACTOR SHALL VERIFY THE ROAD RIGHT-OF-WAY AND EASEMENT PRIOR TO COMMENCING WORK. NO FACILITIES SHOULD BE PLACED ON PRIVATE PROPERTY WITHOUT PRIOR APPROVAL.
3. CONSTRUCTION CONTRACTOR IS RESPONSIBLE FOR VERIFICATION OF ALL DIMENSIONS, QUANTITIES, AND EXISTING CONDITIONS PRIOR TO CONSTRUCTION.
4. ACTUAL LOCATION OF EXISTING UTILITIES TO BE DETERMINED IN THE FIELD AT THE TIME OF CONSTRUCTION. THE CONSTRUCTION CONTRACTOR SHALL CONTACT ALL UTILITY COMPANIES PRIOR TO CONSTRUCTION. THE CONSTRUCTION CONTRACTOR SHALL PROTECT ALL UTILITIES AND SHALL BE RESPONSIBLE FOR ANY DAMAGE INCURRED DURING CONSTRUCTION AND SHALL REPAIR SAID DAMAGES AT THEIR EXPENSE. CALL 811 PRIOR TO CONSTRUCTION FOR UNDERGROUND UTILITY LOCATIONS
5. ALL PROPOSED DIRECTIONAL BORINGS SHALL BE WITHIN THE RIGHT-OF-WAY AT A MINIMUM DISTANCE OF 2' FROM THE BACK OF CURB AND WITH A MINIMUM DEPTH OF 36" UNLESS OTHERWISE NOTED. KEEP A MINIMUM DISTANCE OF 1' TO 2' FROM EXISTING UNDERGROUND UTILITIES.
6. FOR NIGHTS AND WEEKENDS, ANY EXCAVATED AREAS SUCH AS BORE PITS, FLOWER POTS, AND HAND HOLES NEEDS TO BE PROPERLY COVERED OR FENCED OFF. NO EXPOSED AREAS.
7. ALLEY CONSTRUCTION WILL BE PERFORMED BY CLOSING ALLEY WHILE CONSTRUCTION OCCURS WITH PROPER BARRICADES AND SIGNAGE.

**Disclaimer: Utility and property lines are shown for reference only. It is the Contractor's responsibility to validate the information to ensure no underground utilities are damaged and installed infrastructure is within public right-of-way.**

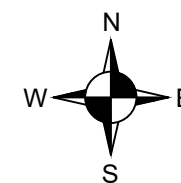

F POT

F POT

F POT

F POT

Lat: 26.299489  
Long: -98.254006

N BENTSEN RD

SAPPHIRE ST

DRIVEWAY AND IRX EASE

15' IRP EASEMENT

15' U.E.

RANCHO B2Z

BORE @ A MIN DEPTH OF 36", 1-2' AWAY FROM ANY EXISTING UG UTILITIES

Legend













	Active Cabinet		Passive Cabinet
	Pole		Handhole
	Parcel		Pedestal
	Flower Pot		Aerial Length
	Buried Length		Aerial Fiber
	Buried Fiber		
	Strand		

- NOTES:
1. PROPOSED FIBER OPTIC DESIGN IS BASED ON AUTOCAD MAP3D GEO MAPPING.
  2. PROPERTY LINES ARE SHOWN FOR REFERENCE ONLY. CONSTRUCTION CONTRACTOR SHALL VERIFY THE ROAD RIGHT-OF-WAY AND EASEMENT PRIOR TO COMMENCING WORK. NO FACILITIES SHOULD BE PLACED ON PRIVATE PROPERTY WITHOUT PRIOR APPROVAL.
  3. CONSTRUCTION CONTRACTOR IS RESPONSIBLE FOR VERIFICATION OF ALL DIMENSIONS, QUANTITIES, AND EXISTING CONDITIONS PRIOR TO CONSTRUCTION.
  4. ACTUAL LOCATION OF EXISTING UTILITIES TO BE DETERMINED IN THE FIELD AT THE TIME OF CONSTRUCTION. THE CONSTRUCTION CONTRACTOR SHALL CONTACT ALL UTILITY COMPANIES PRIOR TO CONSTRUCTION. THE CONSTRUCTION CONTRACTOR SHALL PROTECT ALL UTILITIES AND SHALL BE RESPONSIBLE FOR ANY DAMAGE INCURRED DURING CONSTRUCTION AND SHALL REPAIR SAID DAMAGES AT THEIR EXPENSE. CALL 811 PRIOR TO CONSTRUCTION FOR UNDERGROUND UTILITY LOCATIONS
  5. ALL PROPOSED DIRECTIONAL BORINGS SHALL BE WITHIN THE RIGHT-OF-WAY AT A MINIMUM DISTANCE OF 2' FROM THE BACK OF CURB AND WITH A MINIMUM DEPTH OF 36" UNLESS OTHERWISE NOTED. KEEP A MINIMUM DISTANCE OF 1' TO 2' FROM EXISTING UNDERGROUND UTILITIES.
  6. FOR NIGHTS AND WEEKENDS, ANY EXCAVATED AREAS SUCH AS BORE PITS, FLOWER POTS, AND HAND HOLES NEEDS TO BE PROPERLY COVERED OR FENCED OFF. NO EXPOSED AREAS.
  7. ALLEY CONSTRUCTION WILL BE PERFORMED BY CLOSING ALLEY WHILE CONSTRUCTION OCCURS WITH PROPER BARRICADES AND SIGNAGE.

**Disclaimer: Utility and property lines are shown for reference only. It is the Contractor's responsibility to validate the information to ensure no underground utilities are damaged and installed infrastructure is within public right-of-way.**



Legend

 Active Cabinet	 Passive Cabinet
 Pole	 Handhole
 Parcel	 Pedestal
 Flower Pot	 Aerial Length
 Buried Length	 Aerial Fiber
 Buried Fiber	 Strand

NOTES:

1. PROPOSED FIBER OPTIC DESIGN IS BASED ON AUTOCAD MAP3D GEO MAPPING.
2. PROPERTY LINES ARE SHOWN FOR REFERENCE ONLY. CONSTRUCTION CONTRACTOR SHALL VERIFY THE ROAD RIGHT-OF-WAY AND EASEMENT PRIOR TO COMMENCING WORK. NO FACILITIES SHOULD BE PLACED ON PRIVATE PROPERTY WITHOUT PRIOR APPROVAL.
3. CONSTRUCTION CONTRACTOR IS RESPONSIBLE FOR VERIFICATION OF ALL DIMENSIONS, QUANTITIES, AND EXISTING CONDITIONS PRIOR TO CONSTRUCTION.
4. ACTUAL LOCATION OF EXISTING UTILITIES TO BE DETERMINED IN THE FIELD AT THE TIME OF CONSTRUCTION. THE CONSTRUCTION CONTRACTOR SHALL CONTACT ALL UTILITY COMPANIES PRIOR TO CONSTRUCTION. THE CONSTRUCTION CONTRACTOR SHALL PROTECT ALL UTILITIES AND SHALL BE RESPONSIBLE FOR ANY DAMAGE INCURRED DURING CONSTRUCTION AND SHALL REPAIR SAID DAMAGES AT THEIR EXPENSE. CALL 811 PRIOR TO CONSTRUCTION FOR UNDERGROUND UTILITY LOCATIONS
5. ALL PROPOSED DIRECTIONAL BORINGS SHALL BE WITHIN THE RIGHT-OF-WAY AT A MINIMUM DISTANCE OF 2' FROM THE BACK OF CURB AND WITH A MINIMUM DEPTH OF 36" UNLESS OTHERWISE NOTED. KEEP A MINIMUM DISTANCE OF 1' TO 2' FROM EXISTING UNDERGROUND UTILITIES.
6. FOR NIGHTS AND WEEKENDS, ANY EXCAVATED AREAS SUCH AS BORE PITS, FLOWER POTS, AND HAND HOLES NEEDS TO BE PROPERLY COVERED OR FENCED OFF. NO EXPOSED AREAS.
7. ALLEY CONSTRUCTION WILL BE PERFORMED BY CLOSING ALLEY WHILE CONSTRUCTION OCCURS WITH PROPER BARRICADES AND SIGNAGE.

**Disclaimer: Utility and property lines are shown for reference only. It is the Contractor's responsibility to validate the information to ensure no underground utilities are damaged and installed infrastructure is within public right-of-way.**

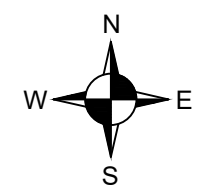

MATCHLINE SHEET 7

Lat: 26.296414  
Long: -98.274167

HH - 30x48x24

HH - 17x30x18

**BORE @ A MIN DEPTH OF 36", 1-2' AWAY FROM ANY EXISTING UG UTILITIES**



MATCHLINE SHEET 11

HIDALGO, TX  
EDBG\_06\_004  
UG PERMIT

**Legend**

	Active Cabinet		Passive Cabinet
	Pole		Handhole
	Parcel		Pedestal
	Flower Pot		Aerial Length
	Buried Length		Aerial Fiber
	Buried Fiber		
	Strand		

- NOTES:**
1. PROPOSED FIBER OPTIC DESIGN IS BASED ON AUTOCAD MAP3D GEO MAPPING.
  2. PROPERTY LINES ARE SHOWN FOR REFERENCE ONLY. CONSTRUCTION CONTRACTOR SHALL VERIFY THE ROAD RIGHT-OF-WAY AND EASEMENT PRIOR TO COMMENCING WORK. NO FACILITIES SHOULD BE PLACED ON PRIVATE PROPERTY WITHOUT PRIOR APPROVAL.
  3. CONSTRUCTION CONTRACTOR IS RESPONSIBLE FOR VERIFICATION OF ALL DIMENSIONS, QUANTITIES, AND EXISTING CONDITIONS PRIOR TO CONSTRUCTION.
  4. ACTUAL LOCATION OF EXISTING UTILITIES TO BE DETERMINED IN THE FIELD AT THE TIME OF CONSTRUCTION. THE CONSTRUCTION CONTRACTOR SHALL CONTACT ALL UTILITY COMPANIES PRIOR TO CONSTRUCTION. THE CONSTRUCTION CONTRACTOR SHALL PROTECT ALL UTILITIES AND SHALL BE RESPONSIBLE FOR ANY DAMAGE INCURRED DURING CONSTRUCTION AND SHALL REPAIR SAID DAMAGES AT THEIR EXPENSE. CALL 811 PRIOR TO CONSTRUCTION FOR UNDERGROUND UTILITY LOCATIONS
  5. ALL PROPOSED DIRECTIONAL BORINGS SHALL BE WITHIN THE RIGHT-OF-WAY AT A MINIMUM DISTANCE OF 2' FROM THE BACK OF CURB AND WITH A MINIMUM DEPTH OF 36" UNLESS OTHERWISE NOTED. KEEP A MINIMUM DISTANCE OF 1' TO 2' FROM EXISTING UNDERGROUND UTILITIES.
  6. FOR NIGHTS AND WEEKENDS, ANY EXCAVATED AREAS SUCH AS BORE PITS, FLOWER POTS, AND HAND HOLES NEEDS TO BE PROPERLY COVERED OR FENCED OFF. NO EXPOSED AREAS.
  7. ALLEY CONSTRUCTION WILL BE PERFORMED BY CLOSING ALLEY WHILE CONSTRUCTION OCCURS WITH PROPER BARRICADES AND SIGNAGE.

**Disclaimer: Utility and property lines are shown for reference only. It is the Contractor's responsibility to validate the information to ensure no underground utilities are damaged and installed infrastructure is within public right-of-way.**

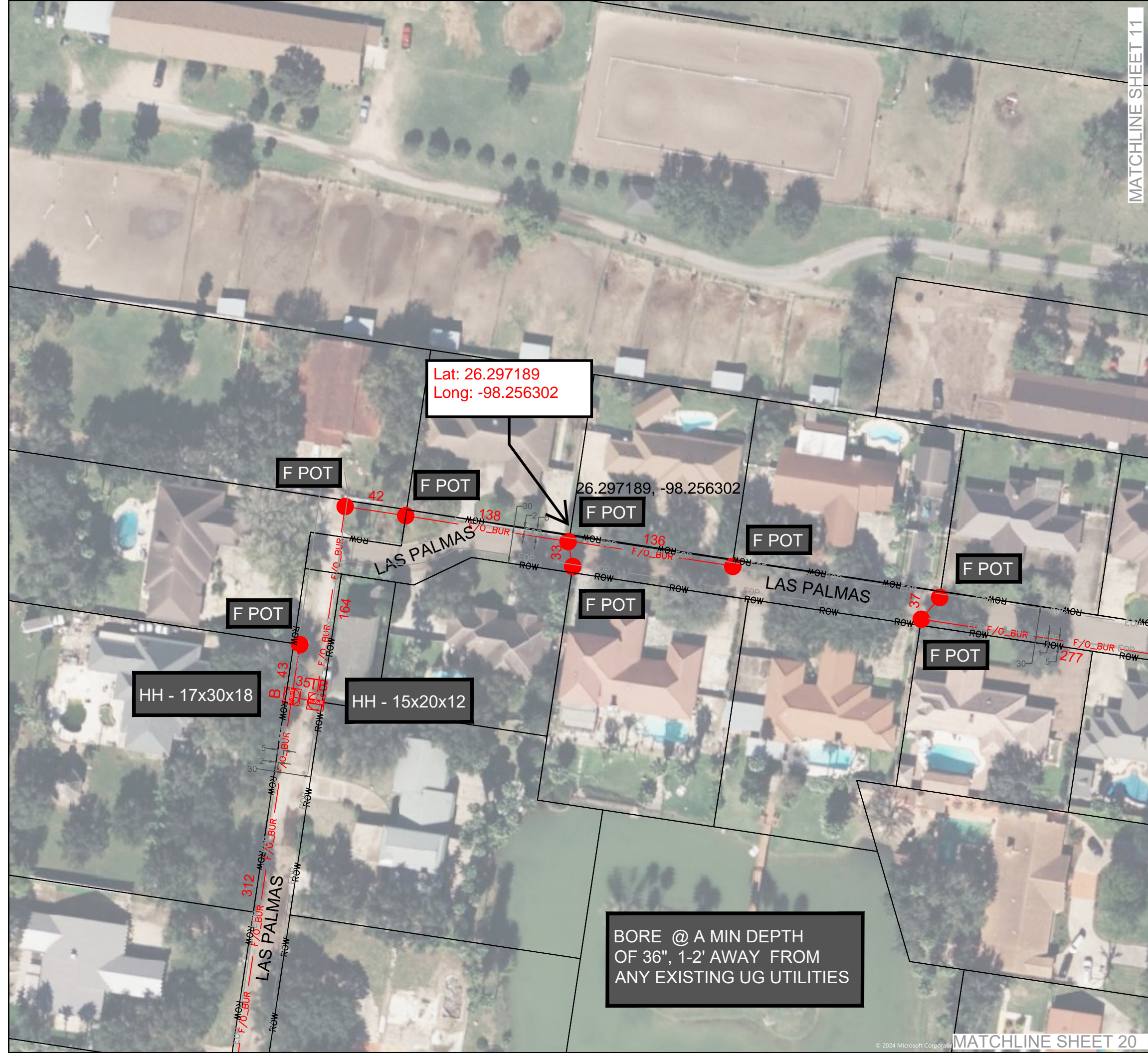

MATCHLINE SHEET 20

© 2024 Microsoft Corporation

MATCHLINE SHEET 11

MATCHLINE SHEET 13

BORE @ A MIN DEPTH OF 36", 1-2' AWAY FROM ANY EXISTING UG UTILITIES

**Legend**

	Active Cabinet		Passive Cabinet
	Pole		Handhole
	Parcel		Pedestal
	Flower Pot		Aerial Length
	Buried Length		Aerial Fiber
	Buried Fiber		
	Strand		

- NOTES:
1. PROPOSED FIBER OPTIC DESIGN IS BASED ON AUTOCAD MAP3D GEO MAPPING.
  2. PROPERTY LINES ARE SHOWN FOR REFERENCE ONLY. CONSTRUCTION CONTRACTOR SHALL VERIFY THE ROAD RIGHT-OF-WAY AND EASEMENT PRIOR TO COMMENCING WORK. NO FACILITIES SHOULD BE PLACED ON PRIVATE PROPERTY WITHOUT PRIOR APPROVAL.
  3. CONSTRUCTION CONTRACTOR IS RESPONSIBLE FOR VERIFICATION OF ALL DIMENSIONS, QUANTITIES, AND EXISTING CONDITIONS PRIOR TO CONSTRUCTION.
  4. ACTUAL LOCATION OF EXISTING UTILITIES TO BE DETERMINED IN THE FIELD AT THE TIME OF CONSTRUCTION. THE CONSTRUCTION CONTRACTOR SHALL CONTACT ALL UTILITY COMPANIES PRIOR TO CONSTRUCTION. THE CONSTRUCTION CONTRACTOR SHALL PROTECT ALL UTILITIES AND SHALL BE RESPONSIBLE FOR ANY DAMAGE INCURRED DURING CONSTRUCTION AND SHALL REPAIR SAID DAMAGES AT THEIR EXPENSE. CALL 811 PRIOR TO CONSTRUCTION FOR UNDERGROUND UTILITY LOCATIONS
  5. ALL PROPOSED DIRECTIONAL BORINGS SHALL BE WITHIN THE RIGHT-OF-WAY AT A MINIMUM DISTANCE OF 2' FROM THE BACK OF CURB AND WITH A MINIMUM DEPTH OF 36" UNLESS OTHERWISE NOTED. KEEP A MINIMUM DISTANCE OF 1' TO 2' FROM EXISTING UNDERGROUND UTILITIES.
  6. FOR NIGHTS AND WEEKENDS, ANY EXCAVATED AREAS SUCH AS BORE PITS, FLOWER POTS, AND HAND HOLES NEEDS TO BE PROPERLY COVERED OR FENCED OFF. NO EXPOSED AREAS.
  7. ALLEY CONSTRUCTION WILL BE PERFORMED BY CLOSING ALLEY WHILE CONSTRUCTION OCCURS WITH PROPER BARRICADES AND SIGNAGE.

**Disclaimer: Utility and property lines are shown for reference only. It is the Contractor's responsibility to validate the information to ensure no underground utilities are damaged and installed infrastructure is within public right-of-way.**





**BORE @ A MIN DEPTH OF 36", 1-2' AWAY FROM ANY EXISTING UG UTILITIES**

Lat: 26.296865  
Long: -98.247424

**Legend**

- Active Cabinet
- Passive Cabinet
- Pole
- Handhole
- Pedestal
- Aerial Length
- Aerial Fiber
- Buried Length
- Buried Fiber
- Strand

**NOTES:**

1. PROPOSED FIBER OPTIC DESIGN IS BASED ON AUTOCAD MAP3D GEO MAPPING.
2. PROPERTY LINES ARE SHOWN FOR REFERENCE ONLY. CONSTRUCTION CONTRACTOR SHALL VERIFY THE ROAD RIGHT-OF-WAY AND EASEMENT PRIOR TO COMMENCING WORK. NO FACILITIES SHOULD BE PLACED ON PRIVATE PROPERTY WITHOUT PRIOR APPROVAL.
3. CONSTRUCTION CONTRACTOR IS RESPONSIBLE FOR VERIFICATION OF ALL DIMENSIONS, QUANTITIES, AND EXISTING CONDITIONS PRIOR TO CONSTRUCTION.
4. ACTUAL LOCATION OF EXISTING UTILITIES TO BE DETERMINED IN THE FIELD AT THE TIME OF CONSTRUCTION. THE CONSTRUCTION CONTRACTOR SHALL CONTACT ALL UTILITY COMPANIES PRIOR TO CONSTRUCTION. THE CONSTRUCTION CONTRACTOR SHALL PROTECT ALL UTILITIES AND SHALL BE RESPONSIBLE FOR ANY DAMAGE INCURRED DURING CONSTRUCTION AND SHALL REPAIR SAID DAMAGES AT THEIR EXPENSE. CALL 811 PRIOR TO CONSTRUCTION FOR UNDERGROUND UTILITY LOCATIONS
5. ALL PROPOSED DIRECTIONAL BORINGS SHALL BE WITHIN THE RIGHT-OF-WAY AT A MINIMUM DISTANCE OF 2' FROM THE BACK OF CURB AND WITH A MINIMUM DEPTH OF 36" UNLESS OTHERWISE NOTED. KEEP A MINIMUM DISTANCE OF 1' TO 2' FROM EXISTING UNDERGROUND UTILITIES.
6. FOR NIGHTS AND WEEKENDS, ANY EXCAVATED AREAS SUCH AS BORE PITS, FLOWER POTS, AND HAND HOLES NEEDS TO BE PROPERLY COVERED OR FENCED OFF. NO EXPOSED AREAS.
7. ALLEY CONSTRUCTION WILL BE PERFORMED BY CLOSING ALLEY WHILE CONSTRUCTION OCCURS WITH PROPER BARRICADES AND SIGNAGE.

**Disclaimer: Utility and property lines are shown for reference only. It is the Contractor's responsibility to validate the information to ensure no underground utilities are damaged and installed infrastructure is within public right-of-way.**



BORE @ A MIN DEPTH  
OF 36", 1-2' AWAY FROM  
ANY EXISTING UG UTILITIES

Legend

	Active Cabinet		Passive Cabinet
	Pole		Handhole
	Parcel		Pedestal
	Flower Pot		Aerial Length
	Buried Length		Aerial Fiber
	Buried Fiber		
	Strand		

- NOTES:
1. PROPOSED FIBER OPTIC DESIGN IS BASED ON AUTOCAD MAP3D GEO MAPPING.
  2. PROPERTY LINES ARE SHOWN FOR REFERENCE ONLY. CONSTRUCTION CONTRACTOR SHALL VERIFY THE ROAD RIGHT-OF-WAY AND EASEMENT PRIOR TO COMMENCING WORK. NO FACILITIES SHOULD BE PLACED ON PRIVATE PROPERTY WITHOUT PRIOR APPROVAL.
  3. CONSTRUCTION CONTRACTOR IS RESPONSIBLE FOR VERIFICATION OF ALL DIMENSIONS, QUANTITIES, AND EXISTING CONDITIONS PRIOR TO CONSTRUCTION.
  4. ACTUAL LOCATION OF EXISTING UTILITIES TO BE DETERMINED IN THE FIELD AT THE TIME OF CONSTRUCTION. THE CONSTRUCTION CONTRACTOR SHALL CONTACT ALL UTILITY COMPANIES PRIOR TO CONSTRUCTION. THE CONSTRUCTION CONTRACTOR SHALL PROTECT ALL UTILITIES AND SHALL BE RESPONSIBLE FOR ANY DAMAGE INCURRED DURING CONSTRUCTION AND SHALL REPAIR SAID DAMAGES AT THEIR EXPENSE. CALL 811 PRIOR TO CONSTRUCTION FOR UNDERGROUND UTILITY LOCATIONS
  5. ALL PROPOSED DIRECTIONAL BORINGS SHALL BE WITHIN THE RIGHT-OF-WAY AT A MINIMUM DISTANCE OF 2' FROM THE BACK OF CURB AND WITH A MINIMUM DEPTH OF 36" UNLESS OTHERWISE NOTED. KEEP A MINIMUM DISTANCE OF 1' TO 2' FROM EXISTING UNDERGROUND UTILITIES.
  6. FOR NIGHTS AND WEEKENDS, ANY EXCAVATED AREAS SUCH AS BORE PITS, FLOWER POTS, AND HAND HOLES NEEDS TO BE PROPERLY COVERED OR FENCED OFF. NO EXPOSED AREAS.
  7. ALLEY CONSTRUCTION WILL BE PERFORMED BY CLOSING ALLEY WHILE CONSTRUCTION OCCURS WITH PROPER BARRICADES AND SIGNAGE.





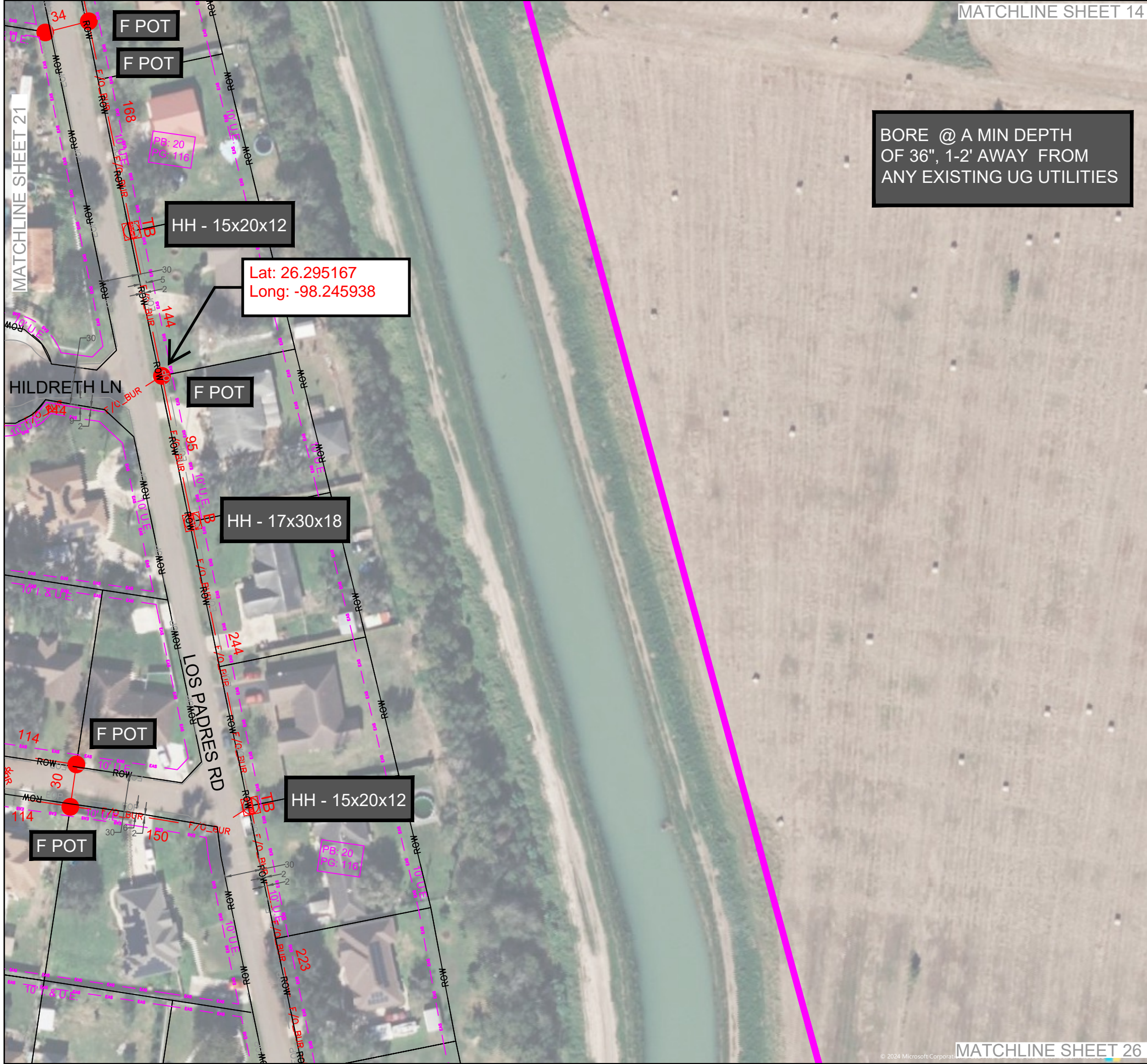





**Disclaimer: Utility and property lines are shown for reference only. It is the Contractor's responsibility to validate the information to ensure no underground utilities are damaged and installed infrastructure is within public right-of-way.**





**BORE @ A MIN DEPTH OF 36", 1-2' AWAY FROM ANY EXISTING UG UTILITIES**

Legend

-  Active Cabinet
-  Passive Cabinet
-  Pole
-  Handhole
-  Pedestal
-  Buried Length
-  Buried Fiber
-  Strand
-  Aerial Length
-  Aerial Fiber

NOTES:

1. PROPOSED FIBER OPTIC DESIGN IS BASED ON AUTOCAD MAP3D GEO MAPPING.
2. PROPERTY LINES ARE SHOWN FOR REFERENCE ONLY. CONSTRUCTION CONTRACTOR SHALL VERIFY THE ROAD RIGHT-OF-WAY AND EASEMENT PRIOR TO COMMENCING WORK. NO FACILITIES SHOULD BE PLACED ON PRIVATE PROPERTY WITHOUT PRIOR APPROVAL.
3. CONSTRUCTION CONTRACTOR IS RESPONSIBLE FOR VERIFICATION OF ALL DIMENSIONS, QUANTITIES, AND EXISTING CONDITIONS PRIOR TO CONSTRUCTION.
4. ACTUAL LOCATION OF EXISTING UTILITIES TO BE DETERMINED IN THE FIELD AT THE TIME OF CONSTRUCTION. THE CONSTRUCTION CONTRACTOR SHALL CONTACT ALL UTILITY COMPANIES PRIOR TO CONSTRUCTION. THE CONSTRUCTION CONTRACTOR SHALL PROTECT ALL UTILITIES AND SHALL BE RESPONSIBLE FOR ANY DAMAGE INCURRED DURING CONSTRUCTION AND SHALL REPAIR SAID DAMAGES AT THEIR EXPENSE. CALL 811 PRIOR TO CONSTRUCTION FOR UNDERGROUND UTILITY LOCATIONS
5. ALL PROPOSED DIRECTIONAL BORINGS SHALL BE WITHIN THE RIGHT-OF-WAY AT A MINIMUM DISTANCE OF 2' FROM THE BACK OF CURB AND WITH A MINIMUM DEPTH OF 36" UNLESS OTHERWISE NOTED. KEEP A MINIMUM DISTANCE OF 1' TO 2' FROM EXISTING UNDERGROUND UTILITIES.
6. FOR NIGHTS AND WEEKENDS, ANY EXCAVATED AREAS SUCH AS BORE PITS, FLOWER POTS, AND HAND HOLES NEEDS TO BE PROPERLY COVERED OR FENCED OFF. NO EXPOSED AREAS.
7. ALLEY CONSTRUCTION WILL BE PERFORMED BY CLOSING ALLEY WHILE CONSTRUCTION OCCURS WITH PROPER BARRICADES AND SIGNAGE.

**Disclaimer: Utility and property lines are shown for reference only. It is the Contractor's responsibility to validate the information to ensure no underground utilities are damaged and installed infrastructure is within public right-of-way.**

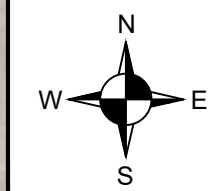

BORE @ A MIN DEPTH OF 36", 1-2' AWAY FROM ANY EXISTING UG UTILITIES

Lat: 26.2926  
Long: -98.24673

Legend

	Active Cabinet		Passive Cabinet
	Pole		Handhole
	Parcel		Pedestal
	Flower Pot		Aerial Length
	Buried Length		Aerial Fiber
	Buried Fiber		
	Strand		

- NOTES:
1. PROPOSED FIBER OPTIC DESIGN IS BASED ON AUTOCAD MAP3D GEO MAPPING.
  2. PROPERTY LINES ARE SHOWN FOR REFERENCE ONLY. CONSTRUCTION CONTRACTOR SHALL VERIFY THE ROAD RIGHT-OF-WAY AND EASEMENT PRIOR TO COMMENCING WORK. NO FACILITIES SHOULD BE PLACED ON PRIVATE PROPERTY WITHOUT PRIOR APPROVAL.
  3. CONSTRUCTION CONTRACTOR IS RESPONSIBLE FOR VERIFICATION OF ALL DIMENSIONS, QUANTITIES, AND EXISTING CONDITIONS PRIOR TO CONSTRUCTION.
  4. ACTUAL LOCATION OF EXISTING UTILITIES TO BE DETERMINED IN THE FIELD AT THE TIME OF CONSTRUCTION. THE CONSTRUCTION CONTRACTOR SHALL CONTACT ALL UTILITY COMPANIES PRIOR TO CONSTRUCTION. THE CONSTRUCTION CONTRACTOR SHALL PROTECT ALL UTILITIES AND SHALL BE RESPONSIBLE FOR ANY DAMAGE INCURRED DURING CONSTRUCTION AND SHALL REPAIR SAID DAMAGES AT THEIR EXPENSE. CALL 811 PRIOR TO CONSTRUCTION FOR UNDERGROUND UTILITY LOCATIONS
  5. ALL PROPOSED DIRECTIONAL BORINGS SHALL BE WITHIN THE RIGHT-OF-WAY AT A MINIMUM DISTANCE OF 2' FROM THE BACK OF CURB AND WITH A MINIMUM DEPTH OF 36" UNLESS OTHERWISE NOTED. KEEP A MINIMUM DISTANCE OF 1' TO 2' FROM EXISTING UNDERGROUND UTILITIES.
  6. FOR NIGHTS AND WEEKENDS, ANY EXCAVATED AREAS SUCH AS BORE PITS, FLOWER POTS, AND HAND HOLES NEEDS TO BE PROPERLY COVERED OR FENCED OFF. NO EXPOSED AREAS.
  7. ALLEY CONSTRUCTION WILL BE PERFORMED BY CLOSING ALLEY WHILE CONSTRUCTION OCCURS WITH PROPER BARRICADES AND SIGNAGE.

**Disclaimer: Utility and property lines are shown for reference only. It is the Contractor's responsibility to validate the information to ensure no underground utilities are damaged and installed infrastructure is within public right-of-way.**

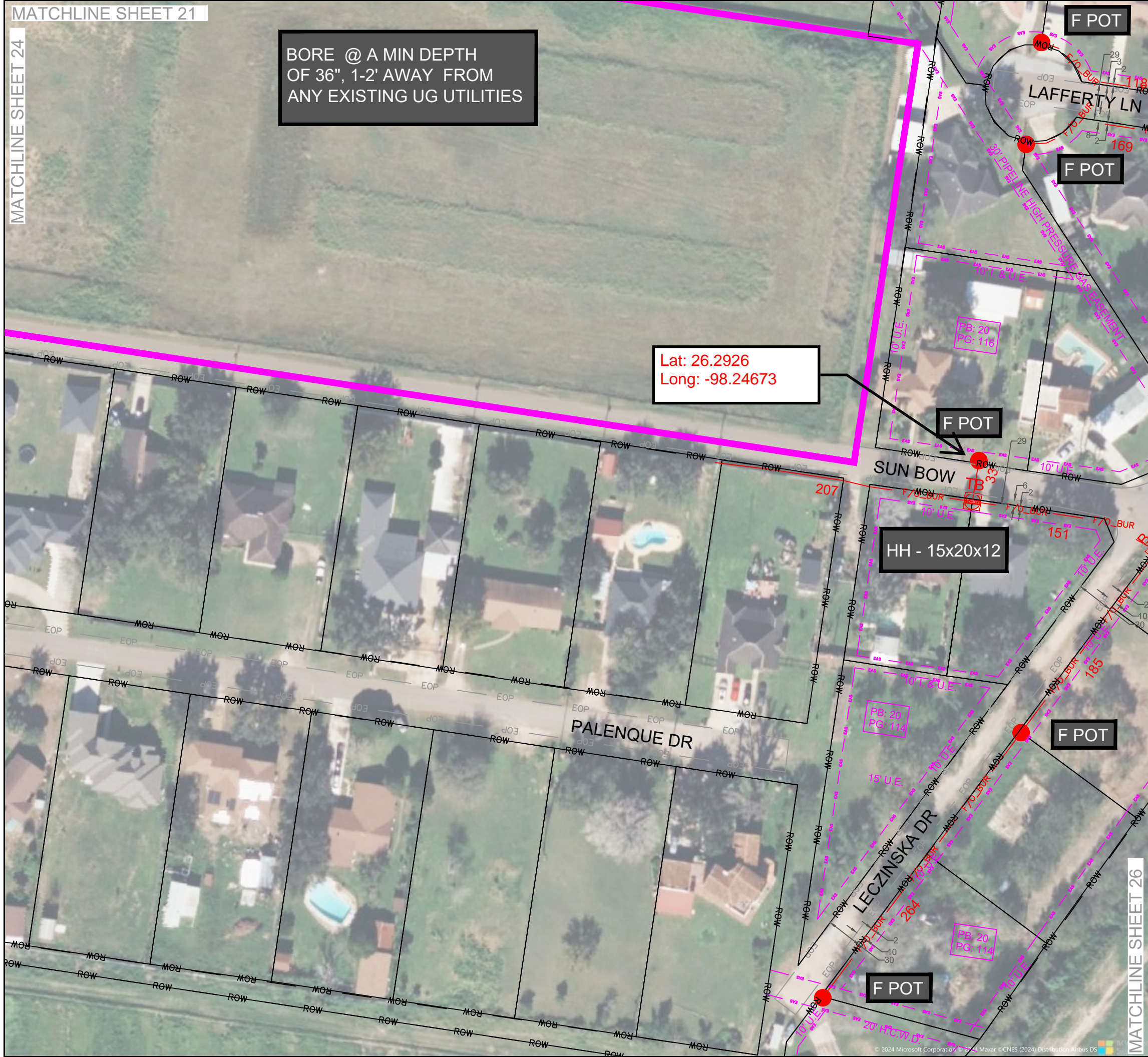

BORE @ A MIN DEPTH OF 36", 1-2' AWAY FROM ANY EXISTING UG UTILITIES

Legend

	Active Cabinet		Passive Cabinet
	Pole		Handhole
	Parcel		Pedestal
	Flower Pot		Aerial Length
	Buried Length		Aerial Fiber
	Buried Fiber		
	Strand		

- NOTES:
1. PROPOSED FIBER OPTIC DESIGN IS BASED ON AUTOCAD MAP3D GEO MAPPING.
  2. PROPERTY LINES ARE SHOWN FOR REFERENCE ONLY. CONSTRUCTION CONTRACTOR SHALL VERIFY THE ROAD RIGHT-OF-WAY AND EASEMENT PRIOR TO COMMENCING WORK. NO FACILITIES SHOULD BE PLACED ON PRIVATE PROPERTY WITHOUT PRIOR APPROVAL.
  3. CONSTRUCTION CONTRACTOR IS RESPONSIBLE FOR VERIFICATION OF ALL DIMENSIONS, QUANTITIES, AND EXISTING CONDITIONS PRIOR TO CONSTRUCTION.
  4. ACTUAL LOCATION OF EXISTING UTILITIES TO BE DETERMINED IN THE FIELD AT THE TIME OF CONSTRUCTION. THE CONSTRUCTION CONTRACTOR SHALL CONTACT ALL UTILITY COMPANIES PRIOR TO CONSTRUCTION. THE CONSTRUCTION CONTRACTOR SHALL PROTECT ALL UTILITIES AND SHALL BE RESPONSIBLE FOR ANY DAMAGE INCURRED DURING CONSTRUCTION AND SHALL REPAIR SAID DAMAGES AT THEIR EXPENSE. CALL 811 PRIOR TO CONSTRUCTION FOR UNDERGROUND UTILITY LOCATIONS
  5. ALL PROPOSED DIRECTIONAL BORINGS SHALL BE WITHIN THE RIGHT-OF-WAY AT A MINIMUM DISTANCE OF 2' FROM THE BACK OF CURB AND WITH A MINIMUM DEPTH OF 36" UNLESS OTHERWISE NOTED. KEEP A MINIMUM DISTANCE OF 1' TO 2' FROM EXISTING UNDERGROUND UTILITIES.
  6. FOR NIGHTS AND WEEKENDS, ANY EXCAVATED AREAS SUCH AS BORE PITS, FLOWER POTS, AND HAND HOLES NEEDS TO BE PROPERLY COVERED OR FENCED OFF. NO EXPOSED AREAS.
  7. ALLEY CONSTRUCTION WILL BE PERFORMED BY CLOSING ALLEY WHILE CONSTRUCTION OCCURS WITH PROPER BARRICADES AND SIGNAGE.

**Disclaimer: Utility and property lines are shown for reference only. It is the Contractor's responsibility to validate the information to ensure no underground utilities are damaged and installed infrastructure is within public right-of-way.**

RISER POLE

Lat: 26.290334  
Long: -98.264169

F POT

HH - 15x20x12

F POT

F POT

HH - 17x30x18

BORE @ A MIN DEPTH OF 36", 1-2' AWAY FROM ANY EXISTING UG UTILITIES

Legend

	Active Cabinet		Passive Cabinet
	Pole		Handhole
	Parcel		Pedestal
	Flower Pot		Aerial Length
	Buried Length		Aerial Fiber
	Buried Fiber		
	Strand		

- NOTES:
1. PROPOSED FIBER OPTIC DESIGN IS BASED ON AUTOCAD MAP3D GEO MAPPING.
  2. PROPERTY LINES ARE SHOWN FOR REFERENCE ONLY. CONSTRUCTION CONTRACTOR SHALL VERIFY THE ROAD RIGHT-OF-WAY AND EASEMENT PRIOR TO COMMENCING WORK. NO FACILITIES SHOULD BE PLACED ON PRIVATE PROPERTY WITHOUT PRIOR APPROVAL.
  3. CONSTRUCTION CONTRACTOR IS RESPONSIBLE FOR VERIFICATION OF ALL DIMENSIONS, QUANTITIES, AND EXISTING CONDITIONS PRIOR TO CONSTRUCTION.
  4. ACTUAL LOCATION OF EXISTING UTILITIES TO BE DETERMINED IN THE FIELD AT THE TIME OF CONSTRUCTION. THE CONSTRUCTION CONTRACTOR SHALL CONTACT ALL UTILITY COMPANIES PRIOR TO CONSTRUCTION. THE CONSTRUCTION CONTRACTOR SHALL PROTECT ALL UTILITIES AND SHALL BE RESPONSIBLE FOR ANY DAMAGE INCURRED DURING CONSTRUCTION AND SHALL REPAIR SAID DAMAGES AT THEIR EXPENSE. CALL 811 PRIOR TO CONSTRUCTION FOR UNDERGROUND UTILITY LOCATIONS
  5. ALL PROPOSED DIRECTIONAL BORINGS SHALL BE WITHIN THE RIGHT-OF-WAY AT A MINIMUM DISTANCE OF 2' FROM THE BACK OF CURB AND WITH A MINIMUM DEPTH OF 36" UNLESS OTHERWISE NOTED. KEEP A MINIMUM DISTANCE OF 1' TO 2' FROM EXISTING UNDERGROUND UTILITIES.
  6. FOR NIGHTS AND WEEKENDS, ANY EXCAVATED AREAS SUCH AS BORE PITS, FLOWER POTS, AND HAND HOLES NEEDS TO BE PROPERLY COVERED OR FENCED OFF. NO EXPOSED AREAS.
  7. ALLEY CONSTRUCTION WILL BE PERFORMED BY CLOSING ALLEY WHILE CONSTRUCTION OCCURS WITH PROPER BARRICADES AND SIGNAGE.

Disclaimer: Utility and property lines are shown for reference only. It is the Contractor's responsibility to validate the information to ensure no underground utilities are damaged and installed infrastructure is within public right-of-way.



Lat: 26.289002  
Long: -98.251418



**Legend**

	Active Cabinet		Passive Cabinet
	Pole		Handhole
	Parcel		Pedestal
	Flower Pot		Aerial Length
	Buried Length		Aerial Fiber
	Buried Fiber		
	Strand		

- NOTES:
1. PROPOSED FIBER OPTIC DESIGN IS BASED ON AUTOCAD MAP3D GEO MAPPING.
  2. PROPERTY LINES ARE SHOWN FOR REFERENCE ONLY. CONSTRUCTION CONTRACTOR SHALL VERIFY THE ROAD RIGHT-OF-WAY AND EASEMENT PRIOR TO COMMENCING WORK. NO FACILITIES SHOULD BE PLACED ON PRIVATE PROPERTY WITHOUT PRIOR APPROVAL.
  3. CONSTRUCTION CONTRACTOR IS RESPONSIBLE FOR VERIFICATION OF ALL DIMENSIONS, QUANTITIES, AND EXISTING CONDITIONS PRIOR TO CONSTRUCTION.
  4. ACTUAL LOCATION OF EXISTING UTILITIES TO BE DETERMINED IN THE FIELD AT THE TIME OF CONSTRUCTION. THE CONSTRUCTION CONTRACTOR SHALL CONTACT ALL UTILITY COMPANIES PRIOR TO CONSTRUCTION. THE CONSTRUCTION CONTRACTOR SHALL PROTECT ALL UTILITIES AND SHALL BE RESPONSIBLE FOR ANY DAMAGE INCURRED DURING CONSTRUCTION AND SHALL REPAIR SAID DAMAGES AT THEIR EXPENSE. CALL 811 PRIOR TO CONSTRUCTION FOR UNDERGROUND UTILITY LOCATIONS
  5. ALL PROPOSED DIRECTIONAL BORINGS SHALL BE WITHIN THE RIGHT-OF-WAY AT A MINIMUM DISTANCE OF 2' FROM THE BACK OF CURB AND WITH A MINIMUM DEPTH OF 36" UNLESS OTHERWISE NOTED. KEEP A MINIMUM DISTANCE OF 1' TO 2' FROM EXISTING UNDERGROUND UTILITIES.
  6. FOR NIGHTS AND WEEKENDS, ANY EXCAVATED AREAS SUCH AS BORE PITS, FLOWER POTS, AND HAND HOLES NEEDS TO BE PROPERLY COVERED OR FENCED OFF. NO EXPOSED AREAS.
  7. ALLEY CONSTRUCTION WILL BE PERFORMED BY CLOSING ALLEY WHILE CONSTRUCTION OCCURS WITH PROPER BARRICADES AND SIGNAGE.

**BORE @ A MIN DEPTH OF 36", 1-2' AWAY FROM ANY EXISTING UG UTILITIES**

**Disclaimer: Utility and property lines are shown for reference only. It is the Contractor's responsibility to validate the information to ensure no underground utilities are damaged and installed infrastructure is within public right-of-way.**

MATCHLINE SHEET 29

Lat: 26.281546  
Long: -98.270422

HH - 17x30x18

F POT

F POT

HH - 17x30x18

HH - 17x30x18

BORE @ A MIN DEPTH  
OF 36", 1-2' AWAY FROM  
ANY EXISTING UG UTILITIES

**Legend**

	Active Cabinet		Passive Cabinet
	Pole		Handhole
	Parcel		Pedestal
	Flower Pot		Aerial Length
	Buried Length		Aerial Fiber
	Buried Fiber		
	Strand		

- NOTES:
1. PROPOSED FIBER OPTIC DESIGN IS BASED ON AUTOCAD MAP3D GEO MAPPING.
  2. PROPERTY LINES ARE SHOWN FOR REFERENCE ONLY. CONSTRUCTION CONTRACTOR SHALL VERIFY THE ROAD RIGHT-OF-WAY AND EASEMENT PRIOR TO COMMENCING WORK. NO FACILITIES SHOULD BE PLACED ON PRIVATE PROPERTY WITHOUT PRIOR APPROVAL.
  3. CONSTRUCTION CONTRACTOR IS RESPONSIBLE FOR VERIFICATION OF ALL DIMENSIONS, QUANTITIES, AND EXISTING CONDITIONS PRIOR TO CONSTRUCTION.
  4. ACTUAL LOCATION OF EXISTING UTILITIES TO BE DETERMINED IN THE FIELD AT THE TIME OF CONSTRUCTION. THE CONSTRUCTION CONTRACTOR SHALL CONTACT ALL UTILITY COMPANIES PRIOR TO CONSTRUCTION. THE CONSTRUCTION CONTRACTOR SHALL PROTECT ALL UTILITIES AND SHALL BE RESPONSIBLE FOR ANY DAMAGE INCURRED DURING CONSTRUCTION AND SHALL REPAIR SAID DAMAGES AT THEIR EXPENSE. CALL 811 PRIOR TO CONSTRUCTION FOR UNDERGROUND UTILITY LOCATIONS
  5. ALL PROPOSED DIRECTIONAL BORINGS SHALL BE WITHIN THE RIGHT-OF-WAY AT A MINIMUM DISTANCE OF 2' FROM THE BACK OF CURB AND WITH A MINIMUM DEPTH OF 36" UNLESS OTHERWISE NOTED. KEEP A MINIMUM DISTANCE OF 1' TO 2' FROM EXISTING UNDERGROUND UTILITIES.
  6. FOR NIGHTS AND WEEKENDS, ANY EXCAVATED AREAS SUCH AS BORE PITS, FLOWER POTS, AND HAND HOLES NEEDS TO BE PROPERLY COVERED OR FENCED OFF. NO EXPOSED AREAS.
  7. ALLEY CONSTRUCTION WILL BE PERFORMED BY CLOSING ALLEY WHILE CONSTRUCTION OCCURS WITH PROPER BARRICADES AND SIGNAGE.

**Disclaimer: Utility and property lines are shown for reference only. It is the Contractor's responsibility to validate the information to ensure no underground utilities are damaged and installed infrastructure is within public right-of-way.**

Lat: 26.298939  
Long: -98.273664

Legend

	Active Cabinet		Passive Cabinet
	Pole		Handhole
	Parcel		Pedestal
	Flower Pot		Aerial Length
	Buried Length		Aerial Fiber
	Buried Fiber		
	Strand		

NOTES:

1. PROPOSED FIBER OPTIC DESIGN IS BASED ON AUTOCAD MAP3D GEO MAPPING.
2. PROPERTY LINES ARE SHOWN FOR REFERENCE ONLY. CONSTRUCTION CONTRACTOR SHALL VERIFY THE ROAD RIGHT-OF-WAY AND EASEMENT PRIOR TO COMMENCING WORK. NO FACILITIES SHOULD BE PLACED ON PRIVATE PROPERTY WITHOUT PRIOR APPROVAL.
3. CONSTRUCTION CONTRACTOR IS RESPONSIBLE FOR VERIFICATION OF ALL DIMENSIONS, QUANTITIES, AND EXISTING CONDITIONS PRIOR TO CONSTRUCTION.
4. ACTUAL LOCATION OF EXISTING UTILITIES TO BE DETERMINED IN THE FIELD AT THE TIME OF CONSTRUCTION. THE CONSTRUCTION CONTRACTOR SHALL CONTACT ALL UTILITY COMPANIES PRIOR TO CONSTRUCTION. THE CONSTRUCTION CONTRACTOR SHALL PROTECT ALL UTILITIES AND SHALL BE RESPONSIBLE FOR ANY DAMAGE INCURRED DURING CONSTRUCTION AND SHALL REPAIR SAID DAMAGES AT THEIR EXPENSE. CALL 811 PRIOR TO CONSTRUCTION FOR UNDERGROUND UTILITY LOCATIONS
5. ALL PROPOSED DIRECTIONAL BORINGS SHALL BE WITHIN THE RIGHT-OF-WAY AT A MINIMUM DISTANCE OF 2' FROM THE BACK OF CURB AND WITH A MINIMUM DEPTH OF 36" UNLESS OTHERWISE NOTED. KEEP A MINIMUM DISTANCE OF 1' TO 2' FROM EXISTING UNDERGROUND UTILITIES.
6. FOR NIGHTS AND WEEKENDS, ANY EXCAVATED AREAS SUCH AS BORE PITS, FLOWER POTS, AND HAND HOLES NEEDS TO BE PROPERLY COVERED OR FENCED OFF. NO EXPOSED AREAS.
7. ALLEY CONSTRUCTION WILL BE PERFORMED BY CLOSING ALLEY WHILE CONSTRUCTION OCCURS WITH PROPER BARRICADES AND SIGNAGE.

**Disclaimer: Utility and property lines are shown for reference only. It is the Contractor's responsibility to validate the information to ensure no underground utilities are damaged and installed infrastructure is within public right-of-way.**

**BORE @ A MIN DEPTH OF 36", 1-2' AWAY FROM ANY EXISTING UG UTILITIES**

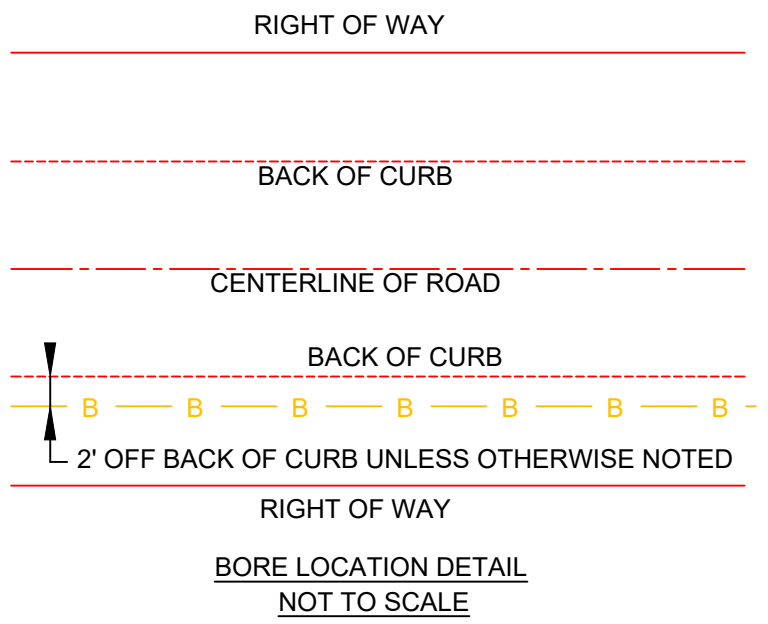
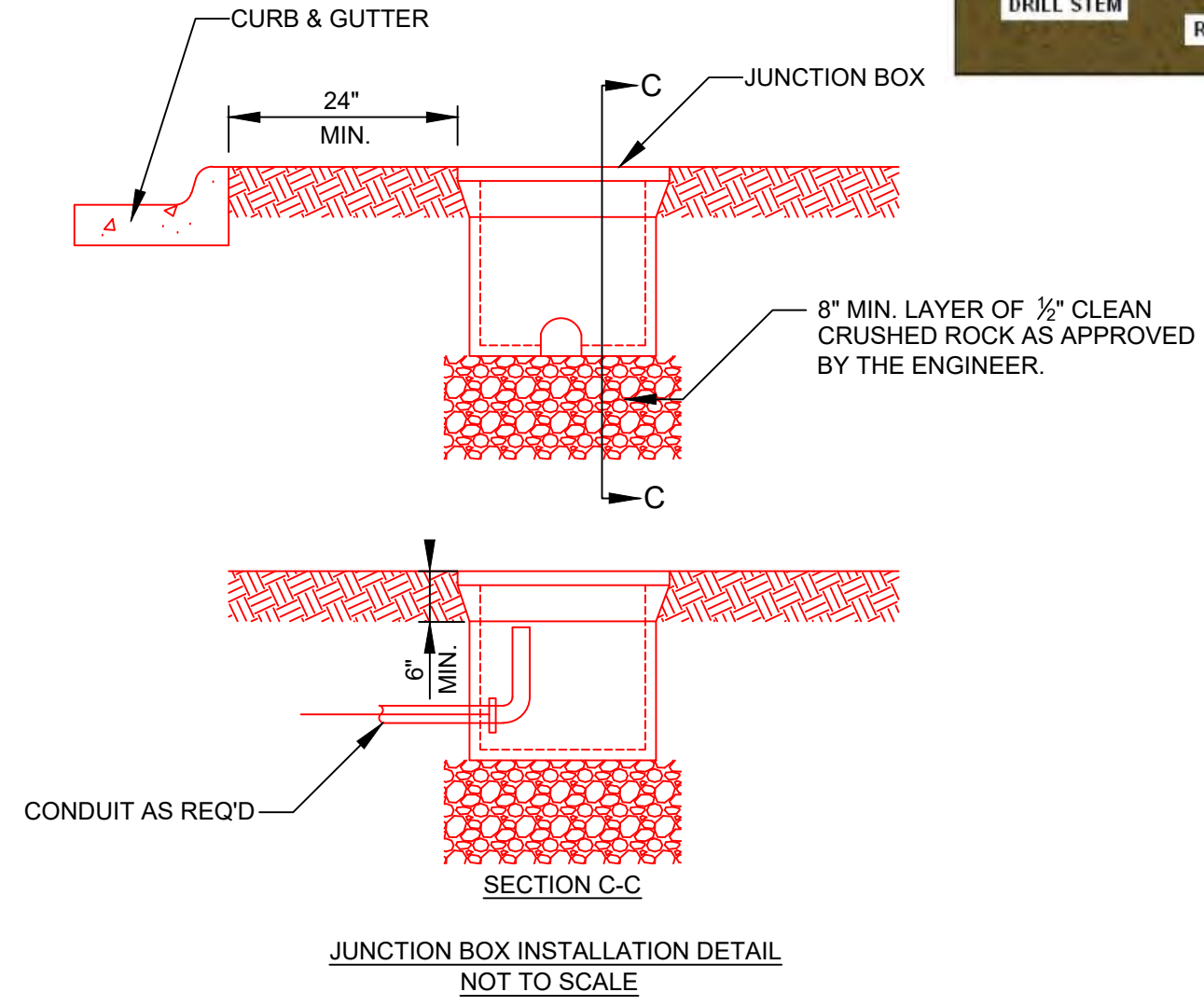
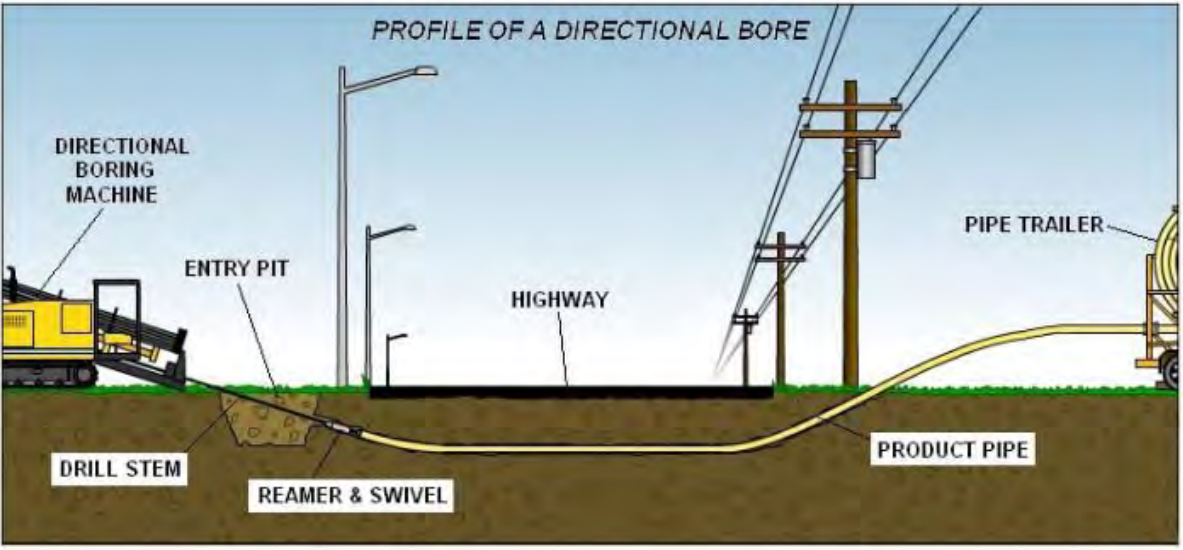

**PRODESIGN**  
ENGINEERING

1295 Lourdes Rd  
Metamora, IL 61548

DRAWN BY:	CHECKED BY:
	DMJ

SUBMITTALS		
DATE	DESCRIPTION	REV

PROJECT NO.

SHEET TITLE  
**DETAILS**

ENGINEER STAMP

**NOTES:**

1. TYPICAL INSTALLATION OFFSET SHALL BE 5' WITHIN THE RIGHT-OF-WAY.
2. ALLEY CONSTRUCTION WILL BE PERFORMED BY CLOSING ALLEY WHILE CONSTRUCTION OCCURS WITH PROPER BARRICADES AND SIGNAGE.
3. ALL ROADWAY WORK SHALL FOLLOW TEXAS DOT MAINTENANCE OF TRAFFIC REQUIREMENTS.
4. DIRECTIONAL DRILLING SHALL BE UTILIZED AS DESIRED BY CONTRACTOR TO MINIMIZE IMPACT TO TREES AND HORTICULTURAL ELEMENTS.
5. APPLICANT SHALL NOTIFY ALL ADJACENT OR OTHERWISE AFFECTED PROPERTY OWNERS VIA DOOR HANGERS PRIOR TO COMMENCING WORK.

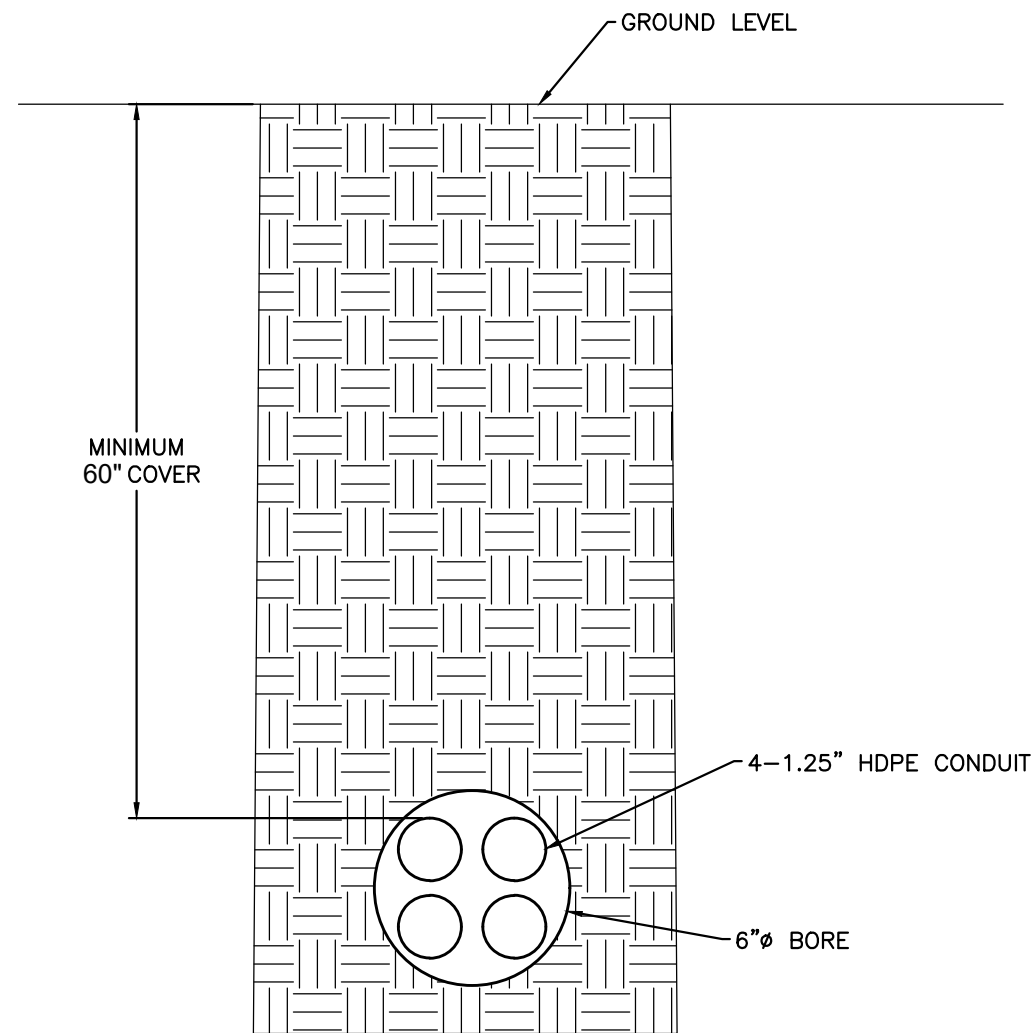

TYPICAL BORE DETAIL  
NTS



1295 Lourdes Rd  
Metamora, IL. 61548

DRAWN BY:	CHECKED BY:
	DMJ

SUBMITTALS		
DATE	DESCRIPTION	REV

TYPICAL BORE  
DETAIL

PROJECT NO.

SHEET TITLE

ENGINEER STAMP

SHEET NUMBER  
OF

E:\OneDrive - EX2 Technology\DWG\Typical Bore Detail.dwg

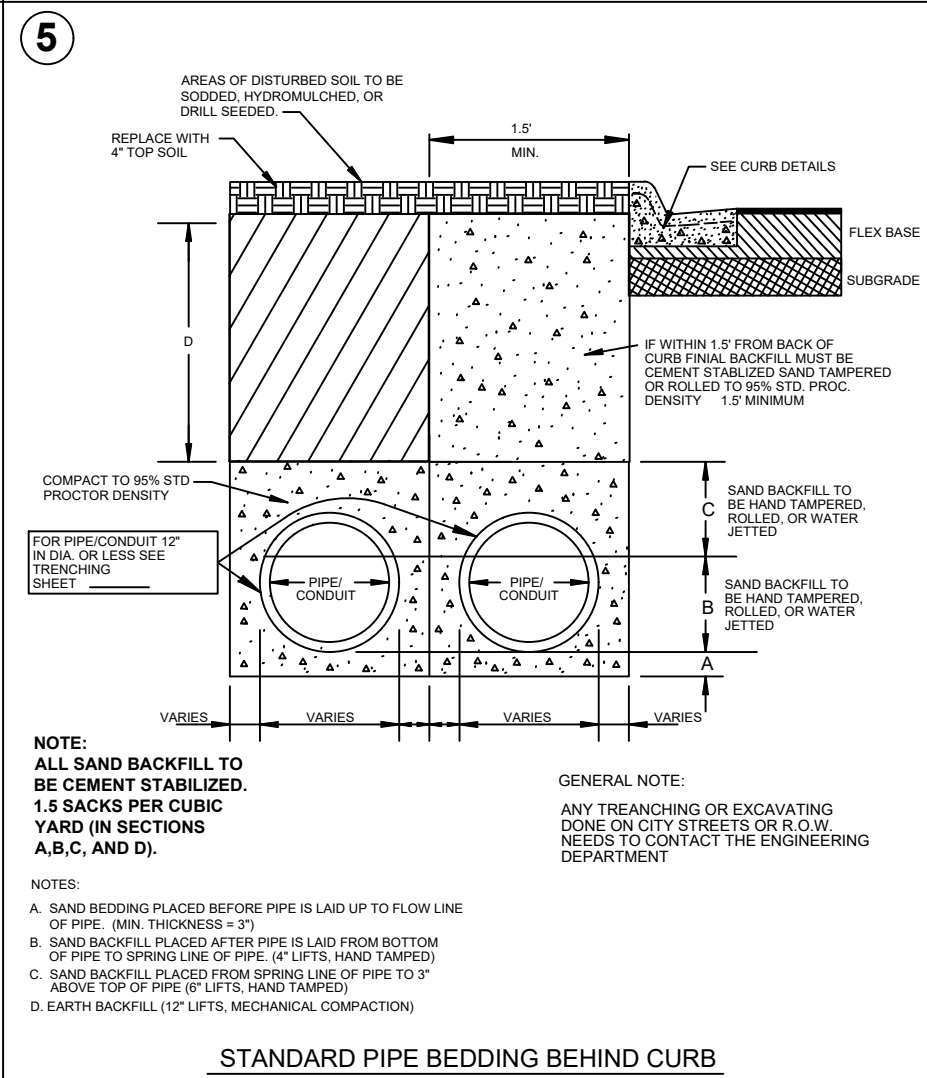
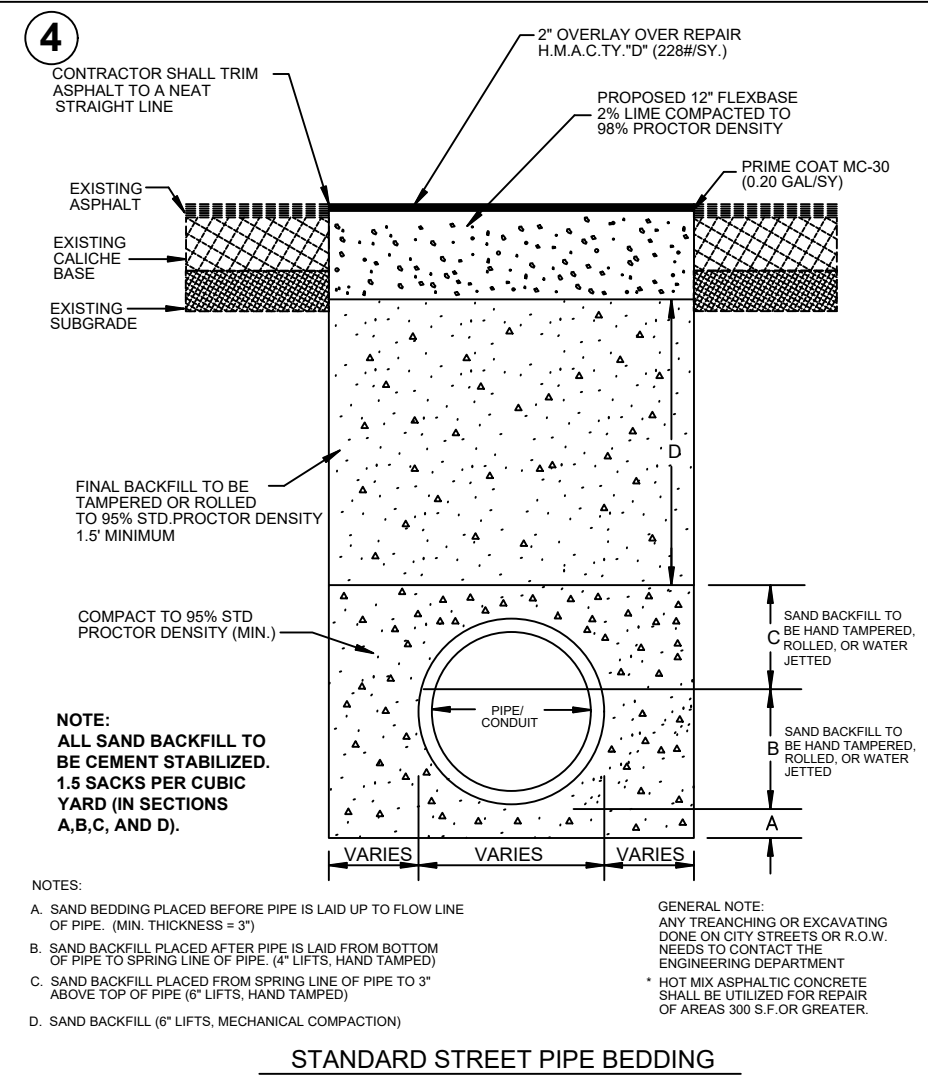
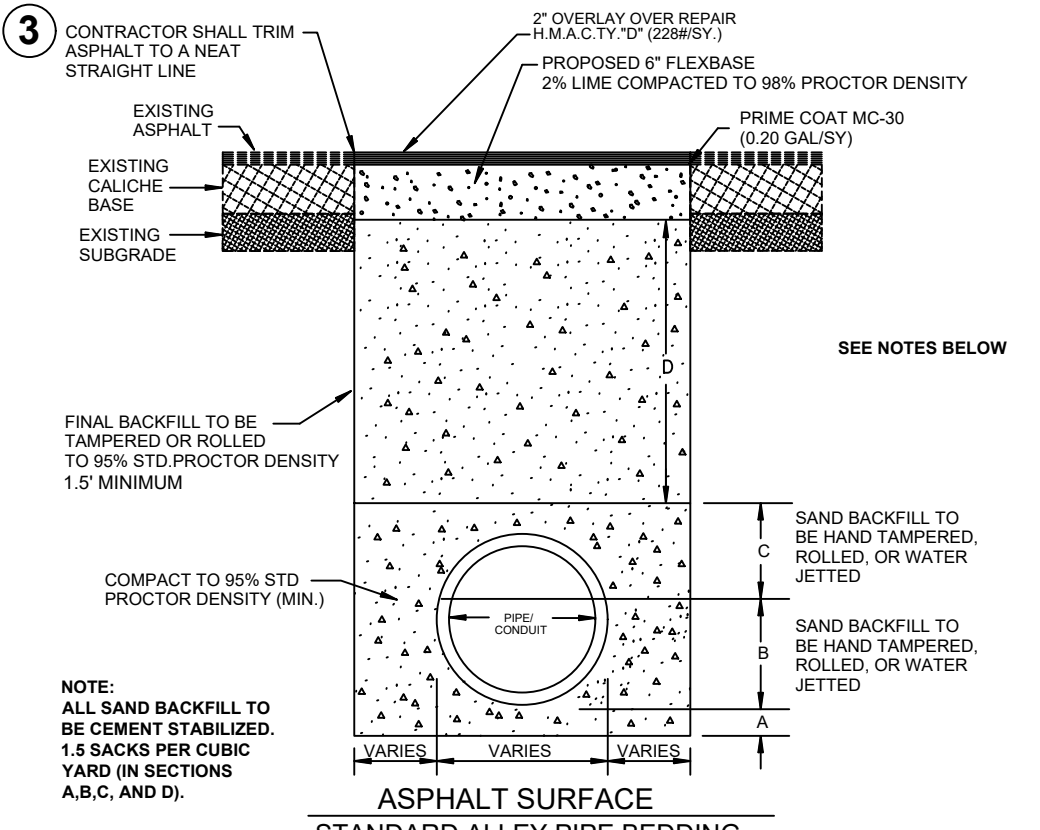
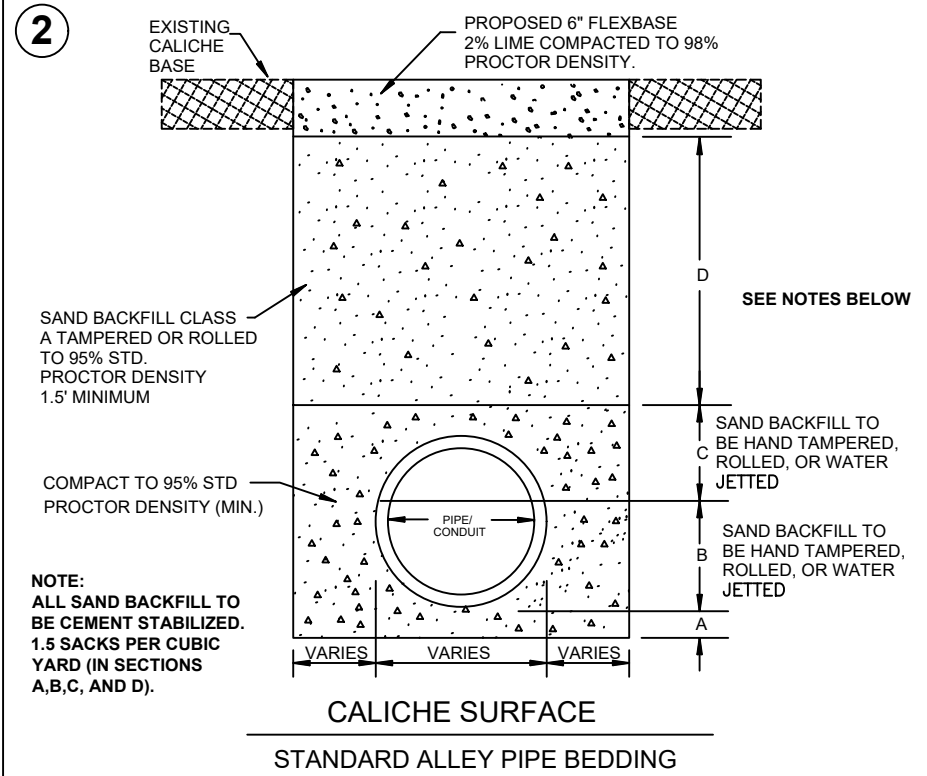
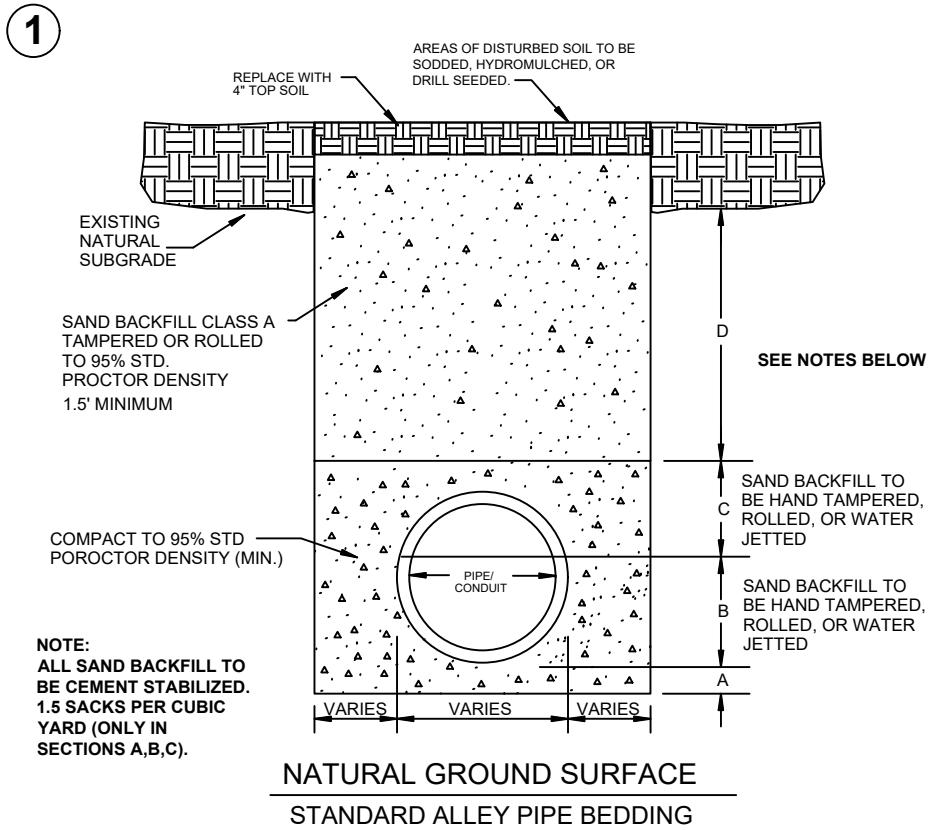

NOTES:

- SAND BEDDING PLACED BEFORE PIPE IS LAID UP TO FLOW LINE OF PIPE. (MIN. THICKNESS = 3")
- SAND BACKFILL PLACED AFTER PIPE IS LAID FROM BOTTOM OF PIPE TO SPRING LINE OF PIPE. (4" LIFTS, HAND TAMPED)
- SAND BACKFILL PLACED FROM SPRING LINE OF PIPE TO 3" ABOVE TOP OF PIPE (6" LIFTS, HAND TAMPED)
- SAND BACKFILL (6" LIFTS, MECHANICAL COMPACTION)

NOTE REGARDING CEMENT STABILIZED SAND BACKFILL: CEMENT STABILIZED SAND IS TO BE USED FOR TRENCHES WITHIN EXISTING ROADWAY SECTIONS OR AS SPECIFIED BY THE ENGINEER OR PLANS.

GENERAL NOTES:

- ANY TRENCHING OR EXCAVATING DONE ON CITY STREETS OR R.O.W. NEEDS TO CONTACT THE ENGINEERING DEPARTMENT
- \* HOT MIX ASPHALTIC CONCRETE SHALL BE UTILIZED FOR REPAIR OF AREAS 300 S.F. OR GREATER.
- ALL SAND TO BE ARROYO SAND (200 WASH 100% PASSING)
- AREAS OF DISTURBED SOIL NOT WITH IN THE STREET OR ALLEY WAY TO BE SODDED, HYDROMULCHED, OR DRILL SEEDED.

NOTE: THE THICKNESS OF EXISTING ASPHALT, FLEXBASE, AND SUBGRADE VARIES.

**PRODESIGN ENGINEERING**

ENGINEERING DEPARTMENT

STANDARD BACKFILL REQUIREMENTS

NOT TO SCALE

PROJECT NO.		FILE NO.	SHEET NO.
		city_backfill.dwg	
STATE	COUNTY	MONTH	YEAR
TEXAS			