



Planning Department

Anthony Uresti
Director of Planning

Main Office

2818 S. Business Hwy 281
Edinburg, Texas 78539
Phone (956) 318-2840
Fax (956) 318-2844

Precinct No. 1 Substation

1900 Joe Stephens Ave. Ste. A
Weslaco, TX 78596
Phone (956) 968-4734
Fax (956) 973-7850

Precinct No. 3 Substation

2401 N. Moorefield Road
Mission, Texas 78572
Phone (956) 205-7045
Fax (956) 205-7049

PIPELINE AND UTILITY PERMIT APPLICATION PACKET

Contact the Director of Hidalgo County Planning Department to discuss the scope of the project

1. Please return the following for processing (in duplicate)
 - a. Permit application form.
 - b. Locator map.
 - c. Plans/profile of pipe or utility crossing.
 - d. Applicant's insurance certificate (in compliance with Schedule A).

2. Check payable to Hidalgo County Planning Department for appropriate fee(s) upon approval by the Hidalgo County Commissioners Court.

Hidalgo County Planning Department will make effort to process permit applications within a minimum of 30 days after receipt of the above required information.

All questions regarding this application should be addressed to the Director of Hidalgo County Planning Department.



**Planning
Department**

Anthony Uresti
Director of Planning

Main Office

2818 S. Business Hwy 281
Edinburg, Texas 78539
Phone (956) 318-2840
Fax (956) 318-2844

Precinct No. 1 Substation

1900 Joe Stephens Ave. Ste. A
Weslaco, TX 78596
Phone (956) 968-4734
Fax (956) 973-7850

Precinct No. 3 Substation

2401 N. Moorefield Road
Mission, Texas 78572
Phone (956) 205-7045
Fax (956) 205-7049

PIPELINE AND UTILITY PERMIT APPLICATION PACKET

THE STATE OF TEXAS

COUNTY OF HIDALGO

PRECINCT _____

**APPLICATION AND AGREEMENT FOR PIPELINE OR
UTILITY PERMIT**

Date: _____

VEXUSFIBER (hereinafter referred to as "Applicant") does hereby make application to the Hidalgo County through the Hidalgo County Planning Department (hereinafter referred to as "HCPD") to construct, maintain and repair pipelines or utilities across the easements, right-of-ways, property or property interest as described below.

Information required:

1. Name, Address and Phone number of Applicant:

VEXUS FIBER, 4006 W LOOP 289 LUBBOCK, TX. 79407

Luis Smith 806-416-8107

2. Name, Address and Phone number of company or agency owning Pipeline or Utility (please indicate if same as Applicant):

VEXUS FIBER (Luis Smith)

4006 W LOOP 289 LUBBOCK, TX. 79407

3. Name, Address and Phone number of operator of Pipeline or Utility (please indicate if same as Applicant):

VEXUS FIBER (Luis Smith)

4006 W LOOP 289 LUBBOCK, TX. 79407

4. Name, Address and Phone number of contractor to install Pipeline or Utility:

BTS 1310 Industrial Way, Harlingen TX., 78550

Cody Fisher 956-367-4112



Planning Department

Anthony Uresti
Director of Planning

Main Office

2818 S. Business Hwy 281
Edinburg, Texas 78539
Phone (956) 318-2840
Fax (956) 318-2844

Precinct No. 1 Substation

1900 Joe Stephens Ave. Ste. A
Weslaco, TX 78596
Phone (956) 968-4734
Fax (956) 973-7850

Precinct No. 3 Substation

2401 N. Moorefield Road
Mission, Texas 78572
Phone (956) 205-7045
Fax (956) 205-7049

PIPELINE AND UTILITY PERMIT APPLICATION PACKET

5. Is this a common carrier pipeline or utility? If yes, please submit the Applicant's Texas Railroad Commission Form "T-4" or similar form designating the facility:

No

6. Does Applicant have the Power of Eminent Domain?

No

7. Will the product be carried for hire or by the owner of the goods?

N/A

8. Name and Legal description of property owner requesting utility services if applicable:

N/A

9. Type of utility work within county road right-of-way:

Bore Crossing Line Extension Along R.O.W. Other _____

10. Where is the origin of the line?

11. Where is the destination of the line?

COVERS MULTIPLE STREETS AS SHOWN IN THE PERMIT
DRAWING



Planning Department

Anthony Uresti
Director of Planning

Main Office

2818 S. Business Hwy 281
Edinburg, Texas 78539
Phone (956) 318-2840
Fax (956) 318-2844

Precinct No. 1 Substation

1900 Joe Stephens Ave. Ste. A
Weslaco, TX 78596
Phone (956) 968-4734
Fax (956) 973-7850

Precinct No. 3 Substation

2401 N. Moorefield Road
Mission, Texas 78572
Phone (956) 205-7045
Fax (956) 205-7049

PIPELINE AND UTILITY PERMIT APPLICATION PACKET

SEE ATTACHMENT FOR STREET INFO

12. Utility Crossing Coordinate X: _____ Y: _____
(NAD 83 Texas South FIPS 4205 feet)
13. Number and size of lines:
PLACING 2" HDPE PIPE BY DIRECTIONAL BORE METHOD AND
PULLING FIBER IN THE DUCT
14. Pressure (each line):
N/A
15. Content (each line):
N/A
16. Estimated date of installation of Pipeline or Utility:
AS SOON AS THIS PERMIT GETS APPROVED BY H.C.
COMMISSIONER COURT



Planning Department

Anthony Uresti
Director of Planning

Main Office

2818 S. Business Hwy 281
Edinburg, Texas 78539
Phone (956) 318-2840
Fax (956) 318-2844

Precinct No. 1 Substation

1900 Joe Stephens Ave. Ste. A
Weslaco, TX 78596
Phone (956) 968-4734
Fax (956) 973-7850

Precinct No. 3 Substation

2401 N. Moorefield Road
Mission, Texas 78572
Phone (956) 205-7045
Fax (956) 205-7049

PIPELINE AND UTILITY PERMIT APPLICATION PACKET

If requested permit is granted by HCPD, Applicant, in consideration thereof, agrees and binds itself as follows:

1. All pipelines or utilities herein will be horizontally placed within the right-of-way as determined by HCPD and at a minimum depth of five (5) feet below natural ground. Depth, horizontal, and vertical location shall be confirmed by HCPD Inspectors.
2. Location map, profile, and plans concerning the proposed pipeline or utility crossing will furnished with this application.
3. HCPD will be notified in writing ten days prior to the beginning date of construction under this permit.
4. Applicant will bear the entire expense of all future relocations of any pipelines or utilities should such relocation, at the sole discretion of the Hidalgo County Commissioners Court, be necessary for improvements, alteration, or maintenance of Hidalgo County's easement or property of interest.
5. Applicant will notify the HCPD at least 48 hours prior to covering work and or completion of its work and removal of its equipment from the job site to permit HCPD to make an inspection.
6. Upon notification by the HCPD, the Applicant will promptly repair or rectify any deficiency or condition caused by the Applicant's operations or installations under this permit. Applicant will leave easement in as near the same condition or better, in the HCPD's sole judgment, as it existed prior to the commencement of the operations under this permit.
7. Hidalgo County shall not be liable or responsible for, and shall be saved and held harmless by Applicant, and further shall be indemnified by Applicant, from and against any and all suits, actions, losses, damages, claims, or liability of any character, type, or description, including all expenses of litigation, court costs, attorney's fees, and engineering fees for injury or death to any person, or injury to any property, received or sustained by any person or persons or property, arising out of, or occasioned by, directly or indirectly, the performance of Applicant under this agreement, including claims and damages arising in part from the negligence of Hidalgo County.



Planning Department

Anthony Uresti
Director of Planning

Main Office

2818 S. Business Hwy 281
Edinburg, Texas 78539
Phone (956) 318-2840
Fax (956) 318-2844

Precinct No. 1 Substation

1900 Joe Stephens Ave. Ste. A
Weslaco, TX 78596
Phone (956) 968-4734
Fax (956) 973-7850

Precinct No. 3 Substation

2401 N. Moorefield Road
Mission, Texas 78572
Phone (956) 205-7045
Fax (956) 205-7049

PIPELINE AND UTILITY PERMIT APPLICATION PACKET

It is the expressed intent of the parties to this agreement that the indemnity provided for in this section is extended by Applicant to indemnify and protect Hidalgo County from the consequences of Hidalgo County's own negligence, whether that negligence is the sole or contributory cause of the resultant injury death, or damage.

Applicant further agrees to defend, at its own expense, with attorneys acceptable to Hidalgo County and on behalf of Hidalgo County, and in the name of Hidalgo County, any claim or litigation brought against Hidalgo County in connection with any such injury, death or damage.

Before construction is begun on such pipeline or utility crossings, Applicant will furnish to the HCPD a certificate of insurance (or other security approved by the HCPD) payable to Hidalgo County and protecting Hidalgo County (as an additional named insured) against any claims for personal injuries or damages to property resulting from the operations of Applicant, its agents, servants, employees, and contractors under this permit. Insurance is to be supplied in accordance with the attached Schedule A.

8. Hidalgo County makes no warranties, expressed or implied, in the granting of this permit; nor does Hidalgo County purport to grant any property interest or exclusive privileges whatsoever by granting such permit. It is specifically understood that Hidalgo County is not the agent for, nor does it act for, the fee owners or any persons or entities having any right, or title to possession of the land upon which Hidalgo County's easement or other property interest is located. Furthermore, in granting this permit Hidalgo County makes no representation or warranty that it has any property interest, including, but not limited to, an easement or right of way, in the land upon which Applicant constructs, maintains, repairs, or modifies the pipelines or utilities, made the subject of this application, nor does Hidalgo County make any representation or warranty as to the validity, quality or extent of such property interest, if any. Applicant acknowledges its understanding that Hidalgo County in granting this permit, does not convey or grant to Applicant any rights, title or interest for which is has no legal authority to grant or convey.
9. Applicant binds itself to comply with all federal, state, and local laws or regulations and will obtain all necessary permits from all local and federal agencies required by law before installation or construction is begun.



Planning Department

Anthony Uresti
Director of Planning

Main Office

2818 S. Business Hwy 281
Edinburg, Texas 78539
Phone (956) 318-2840
Fax (956) 318-2844

Precinct No. 1 Substation

1900 Joe Stephens Ave. Ste. A
Weslaco, TX 78596
Phone (956) 968-4734
Fax (956) 973-7850

Precinct No. 3 Substation

2401 N. Moorefield Road
Mission, Texas 78572
Phone (956) 205-7045
Fax (956) 205-7049

PIPELINE AND UTILITY PERMIT APPLICATION PACKET

10. Applicant will install its pipelines and utilities in a manner and location as shown in the plans and specifications filed with HCPD in support of this application for permit. Hidalgo County Planning Department's representative may at any time make such inspection as such engineer or other representation may deem necessary to assure that the construction of the pipeline or utilities is in accordance with the plans and specifications submitted, and said engineer or representative shall have the right to temporarily suspend Applicant's work if necessary, while such inspection is being made. Should Applicant not install the pipelines or utilities in accordance with the terms and conditions of this permit, Applicant agrees that Hidalgo County shall have the right to require, at Applicant's expense, the removal of the pipelines and utilities and its replacement in conformance to said plans and specifications and conditions of this permit. Hidalgo County may revoke this permit and suspend all work hereunder if it is determined by Hidalgo County that the pipelines or utilities are not being installed in accordance with such plans and specifications and conditions of this permit. The suspension or revocation of this permit shall not be a basis for a claim for damages against Hidalgo County.

11. Except in emergency situations where it is necessary to protect life and property, Applicant will not make any change, modification, or alteration in or to the pipelines or utilities without first securing a new or amended permit from Hidalgo County prior to the making of any such change. Applicant will maintain the pipelines or utilities hereby authorized in good and safe condition, and in accordance with plans, specifications, and this permit.

12. Applicant agrees to pay HCPD a permit fee to cover administrative costs in the amount of **\$500.00**, plus a reimbursement to HCPD for any necessary engineering fees which may be incurred for the study and processing of the Application. This fee will permit a single pipeline or utility to be within County right-of-way. Applicant further agrees to pay an additional fee of **\$500.00** for each additional line included in permit application at the same location; however, more than one location may be included in a single application.

Requests to lay additional line or lines, not included in an initial permit application, must be made by separate application, with new permit fees paid accordingly and support data provided.



Planning Department

Anthony Uresti
Director of Planning

Main Office

2818 S. Business Hwy 281
Edinburg, Texas 78539
Phone (956) 318-2840
Fax (956) 318-2844

Precinct No. 1 Substation

1900 Joe Stephens Ave. Ste. A
Weslaco, TX 78596
Phone (956) 968-4734
Fax (956) 973-7850

Precinct No. 3 Substation

2401 N. Moorefield Road
Mission, Texas 78572
Phone (956) 205-7045
Fax (956) 205-7049

PIPELINE AND UTILITY PERMIT APPLICATION PACKET

Permit fees may be waived where Applicant is a state, county, municipality, or a special political subdivision.

13. The Applicant is allowed one hundred twenty days (120) from the granting of the permit to start construction of the pipelines or utilities crossings. Once started, the Applicant is allowed ninety (90) days to complete all work under such permit. All construction must be completed within two hundred ten (210) days from the date of issuance of permit. Upon application, extension of the time periods set forth in this paragraph may be granted by the Hidalgo County Commissioners Court. Such applications for extension must be received by HCPD at least thirty days before the expiration of the two hundred ten (210) days period. A new permit fee, in accordance with Paragraph 12 hereof, will be charged for each extension granted.

Construction of any pipeline or utility crossing will not begin until written approval has been given by HCPD.

14. All provisions of the Pipeline and Utility Permit Administration Policy of Hidalgo County, if any, and all amendments thereto, are hereby incorporated herein as part of the terms and conditions of this permit for all purposes.
15. Applicant warrants and represents that it has secured from all fee owners of the involved property an easement or other property rights to construct, repair or modify the pipeline or utility in the manner set forth herein.
16. This Pipeline and Utility Permit if granted by Hidalgo County is subject to any and all other requirements, specifications and conditions listed in Exhibit A attached hereto.
17. Hidalgo County requires all coordinates of all utility crossings. Horizontal datum to be in NAD 83 State Plane Texas South 4205 feet and vertical datum in NAVD 88 Geoid 12a.



**Planning
Department**

Anthony Uresti
Director of Planning

Main Office

2818 S. Business Hwy 281
Edinburg, Texas 78539
Phone (956) 318-2840

Precinct No. 1 Substation

1900 Joe Stephens Ave. Ste. A
Weslaco, TX 78596
Phone (956) 968-4734

Precinct No. 3 Substation

2401 N. Moorefield Road
Mission, Texas 78572
Phone (956) 205-7045

PIPELINE AND UTILITY PERMIT APPLICATION PACKET

18. This permit constitutes the entire agreement between the parties with regard to the subject matter hereof, and all prior agreements, representations, and negotiations between the parties regarding the subject matter are hereby superseded. This permit shall not be altered or amended except by an agreement in writing executed by the parties hereto.

19. Applicant warrants and represents that its undersigned representative has full authority to bind Applicant to the terms and conditions of the foregoing Application and Agreement for Pipeline or Utility Permit.

DATED this September day of 2nd, 2025.

Tiffany Rice

(Name of Applicant – Printed or Typed)

By: [Signature]
Signature

Title: Permitting Manager

STATE OF TEXAS
COUNTY OF HIDALGO

SUBSCRIBED AND SWORN TO before me the Applicant,
Tiffany Rice, on this 2 day of Sept., 2025
to which witness my hand and seal of office.

[Signature]

Notary Public for the State of Texas

My Commission Expires: 12/3/2025





**Planning
Department**

Anthony Uresti
Director of Planning

Main Office

2818 S. Business Hwy 281
Edinburg, Texas 78539
Phone (956) 318-2840
Fax (956) 318-2844

Precinct No. 1 Substation

1900 Joe Stephens Ave. Ste. A
Weslaco, TX 78596
Phone (956) 968-4734
Fax (956) 973-7850

Precinct No. 3 Substation

2401 N. Moorefield Road
Mission, Texas 78572
Phone (956) 205-7045
Fax (956) 205-7049

PIPELINE AND UTILITY PERMIT APPLICATION PACKET

**APPROVAL OF APPLICATION BY
HIDALGO COUNTY PLANNING DEPARTMENT**

Came on for consideration this _____ day of _____,
20____. The above and foregoing Application for Pipeline and Utility
Permit, and after consideration of the same by the Hidalgo County
Commissioners Court, said Application and Agreement for Pipeline or
Utility Permit is hereby APPROVED.

HIDALGO COUNTY:

Richard F. Cortez, County Judge



CERTIFICATE OF LIABILITY INSURANCE

DATE (MM/DD/YYYY)

9/29/2025

THIS CERTIFICATE IS ISSUED AS A MATTER OF INFORMATION ONLY AND CONFERS NO RIGHTS UPON THE CERTIFICATE HOLDER. THIS CERTIFICATE DOES NOT AFFIRMATIVELY OR NEGATIVELY AMEND, EXTEND OR ALTER THE COVERAGE AFFORDED BY THE POLICIES BELOW. THIS CERTIFICATE OF INSURANCE DOES NOT CONSTITUTE A CONTRACT BETWEEN THE ISSUING INSURER(S), AUTHORIZED REPRESENTATIVE OR PRODUCER, AND THE CERTIFICATE HOLDER.

IMPORTANT: If the certificate holder is an ADDITIONAL INSURED, the policy(ies) must have ADDITIONAL INSURED provisions or be endorsed. If SUBROGATION IS WAIVED, subject to the terms and conditions of the policy, certain policies may require an endorsement. A statement on this certificate does not confer rights to the certificate holder in lieu of such endorsement(s).

PRODUCER IMA, Inc. - Kansas City 11350 Switzer Rd, Suite 200 Overland Park KS 66210	CONTACT NAME: IMA Certs Team	
	PHONE (A/C, No, Ext):	FAX (A/C, No):
E-MAIL ADDRESS: certificates@imacorp.com		
INSURER(S) AFFORDING COVERAGE		NAIC #
INSURER A: St. Paul Mercury Insurance Company		24791
INSURER B: The Charter Oak Fire Insurance Company		25615
INSURER C: Travelers Property Casualty Company of America		25674
INSURER D: Endurance American Specialty Insurance Company		41718
INSURER E:		
INSURER F:		

 License#: PC-1210733
 METRINC-01

INSURED
 Vexus Fiber, LLC
 11880 College Boulevard, Suite 100
 Overland Park, KS 66210
COVERAGES**CERTIFICATE NUMBER:** 1761231277**REVISION NUMBER:**

THIS IS TO CERTIFY THAT THE POLICIES OF INSURANCE LISTED BELOW HAVE BEEN ISSUED TO THE INSURED NAMED ABOVE FOR THE POLICY PERIOD INDICATED. NOTWITHSTANDING ANY REQUIREMENT, TERM OR CONDITION OF ANY CONTRACT OR OTHER DOCUMENT WITH RESPECT TO WHICH THIS CERTIFICATE MAY BE ISSUED OR MAY PERTAIN, THE INSURANCE AFFORDED BY THE POLICIES DESCRIBED HEREIN IS SUBJECT TO ALL THE TERMS, EXCLUSIONS AND CONDITIONS OF SUCH POLICIES. LIMITS SHOWN MAY HAVE BEEN REDUCED BY PAID CLAIMS.

INSR LTR	TYPE OF INSURANCE	ADDL INSD	SUBR WVD	POLICY NUMBER	POLICY EFF (MM/DD/YYYY)	POLICY EXP (MM/DD/YYYY)	LIMITS
B	<input checked="" type="checkbox"/> COMMERCIAL GENERAL LIABILITY <input type="checkbox"/> CLAIMS-MADE <input checked="" type="checkbox"/> OCCUR GEN'L AGGREGATE LIMIT APPLIES PER: <input checked="" type="checkbox"/> POLICY <input type="checkbox"/> PRO-JECT <input type="checkbox"/> LOC OTHER:			HO6309P532424COF25	10/1/2025	10/1/2026	EACH OCCURRENCE \$ 1,000,000 DAMAGE TO RENTED PREMISES (Ea occurrence) \$ 1,000,000 MED EXP (Any one person) \$ 10,000 PERSONAL & ADV INJURY \$ 1,000,000 GENERAL AGGREGATE \$ 2,000,000 PRODUCTS - COMP/OP AGG \$ 2,000,000 \$
C	<input checked="" type="checkbox"/> AUTOMOBILE LIABILITY <input checked="" type="checkbox"/> ANY AUTO <input type="checkbox"/> OWNED AUTOS ONLY <input type="checkbox"/> SCHEDULED AUTOS <input type="checkbox"/> HIRED AUTOS ONLY <input type="checkbox"/> NON-OWNED AUTOS ONLY			HC2JCAP9P532412TIL25	10/1/2025	10/1/2026	COMBINED SINGLE LIMIT (Ea accident) \$ 1,000,000 BODILY INJURY (Per person) \$ BODILY INJURY (Per accident) \$ PROPERTY DAMAGE (Per accident) \$ \$
C	<input checked="" type="checkbox"/> UMBRELLA LIAB <input checked="" type="checkbox"/> OCCUR <input type="checkbox"/> EXCESS LIAB <input type="checkbox"/> CLAIMS-MADE <input type="checkbox"/> DED <input checked="" type="checkbox"/> RETENTION \$ 10,000			CUP9P53243625I3	10/1/2025	10/1/2026	EACH OCCURRENCE \$ 4,000,000 AGGREGATE \$ 4,000,000 \$
A	WORKERS COMPENSATION AND EMPLOYERS' LIABILITY ANY PROPRIETOR/PARTNER/EXECUTIVE OFFICER/MEMBER EXCLUDED? <input type="checkbox"/> Y <input checked="" type="checkbox"/> N (Mandatory in NH) If yes, describe under DESCRIPTION OF OPERATIONS below		N/A	UB3Y56457325I3K	10/1/2025	10/1/2026	<input checked="" type="checkbox"/> PER STATUTE <input type="checkbox"/> OTH-ER E.L. EACH ACCIDENT \$ 1,000,000 E.L. DISEASE - EA EMPLOYEE \$ 1,000,000 E.L. DISEASE - POLICY LIMIT \$ 1,000,000
B D	Leased/Rented Coverage Cyber Liability			HO6309P532424COF25 CTO30069533501	10/1/2025 10/1/2025	10/1/2026 10/1/2026	Limit \$1,000,000 See Below Deductible \$50,000

DESCRIPTION OF OPERATIONS / LOCATIONS / VEHICLES (ACORD 101, Additional Remarks Schedule, may be attached if more space is required)
 Cyber Liability: Policy #CTO30069533501; Each Occurrence \$10,000,000; Aggregate \$10,000,000; Retention \$150,000.
 The General Liability policy includes a Contractual Liability Railroad endorsement CG D6 47 10 12, subject to policy terms and conditions.
 Certificate Holder and all other parties required by the contract are included as Additional Insured on the General Liability, Automobile Liability and Umbrella Liability Policies, if required by written contract or agreement, subject to the policy terms and conditions.

CERTIFICATE HOLDER**CANCELLATION**
 Hidalgo County
 2818 S Business Hwy 281
 Edinburg TX 78539

SHOULD ANY OF THE ABOVE DESCRIBED POLICIES BE CANCELLED BEFORE THE EXPIRATION DATE THEREOF, NOTICE WILL BE DELIVERED IN ACCORDANCE WITH THE POLICY PROVISIONS.

AUTHORIZED REPRESENTATIVE

© 1988-2015 ACORD CORPORATION. All rights reserved.



PIPELINE AND UTILITY PERMIT APPLICATION PACKET

EXHIBIT A

Planning Department

Anthony Uresti
Director of Planning

Main Office

2818 S. Business Hwy 281
Edinburg, Texas 78539
Phone (956) 318-2840
Fax (956) 318-2844

Precinct No. 1 Substation

1900 Joe Stephens Ave. Ste. A
Weslaco, TX 78596
Phone (956) 968-4734
Fax (956) 973-7850

Precinct No. 3 Substation

2401 N. Moorefield Road
Mission, Texas 78572
Phone (956) 205-7045
Fax (956) 205-7049

(Please insert description of project location and supporting documents for proposed utility work)

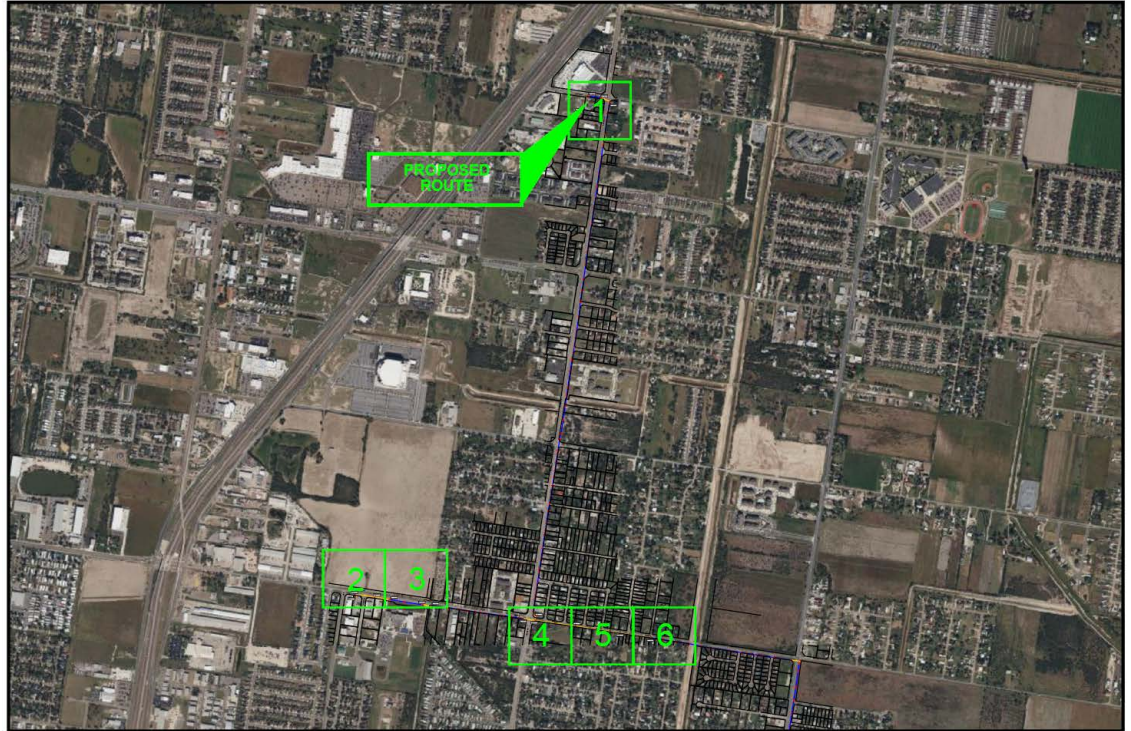

Vexus Fiber PON# CROCKETT #1

County Streets
East to West

E WISCONSIN RD

Lat/Long: 26.2669, -98.1558

Lat/Long: 26.2667, -98.1548

E OWASSA RD

Lat/Long: 26.2463, -98.1665

Lat/Long: 26.2445, -98.1530

North to South

S VETERANS BLVD

Lat/Long: 26.267, -98.1548

Lat/Long: 26.2452, -98.1583

CROCKETT_AVE_PERMIT_UG_HIDALGO-1.dwg

HIDALGO, TX



Notes:

1. All proposed directional borings shall be at a minimum distance of 2' from the back of curb and with a minimum depth of 36" unless otherwise noted. Keep a minimum distance of 1' to 2' from existing underground utilities.
2. For Nights and Weekends, any excavated areas such as bore pits, flower pots, and hand holes needs to be properly covered or fenced off. No exposed areas.
3. During construction of bore pits, flower pots, and hand holes; remove and restore grass areas to equal or better conditions.
4. Alley construction will be performed by closing alley while construction occurs with proper barricades and signage.
5. Contractor shall call 811, prior to construction to have the existing utilities marked.















LINEAR FOOTAGE: 3298 FT

DATE: SEPTEMBER 16, 2024

CONSTRUCTION



Note:
All proposed borings shall be at a minimum distance of 2' from the back of curb and with a minimum depth of 36" unless otherwise noted. Keep a minimum distance of 1' to 2' from existing underground utilities.







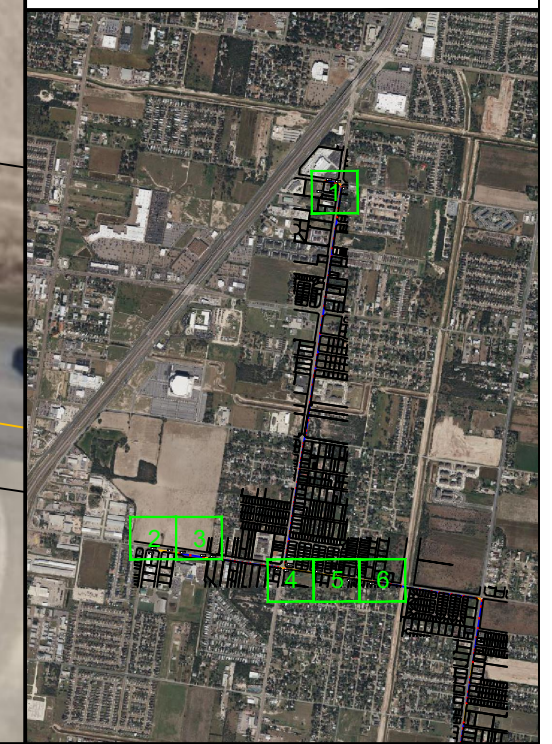
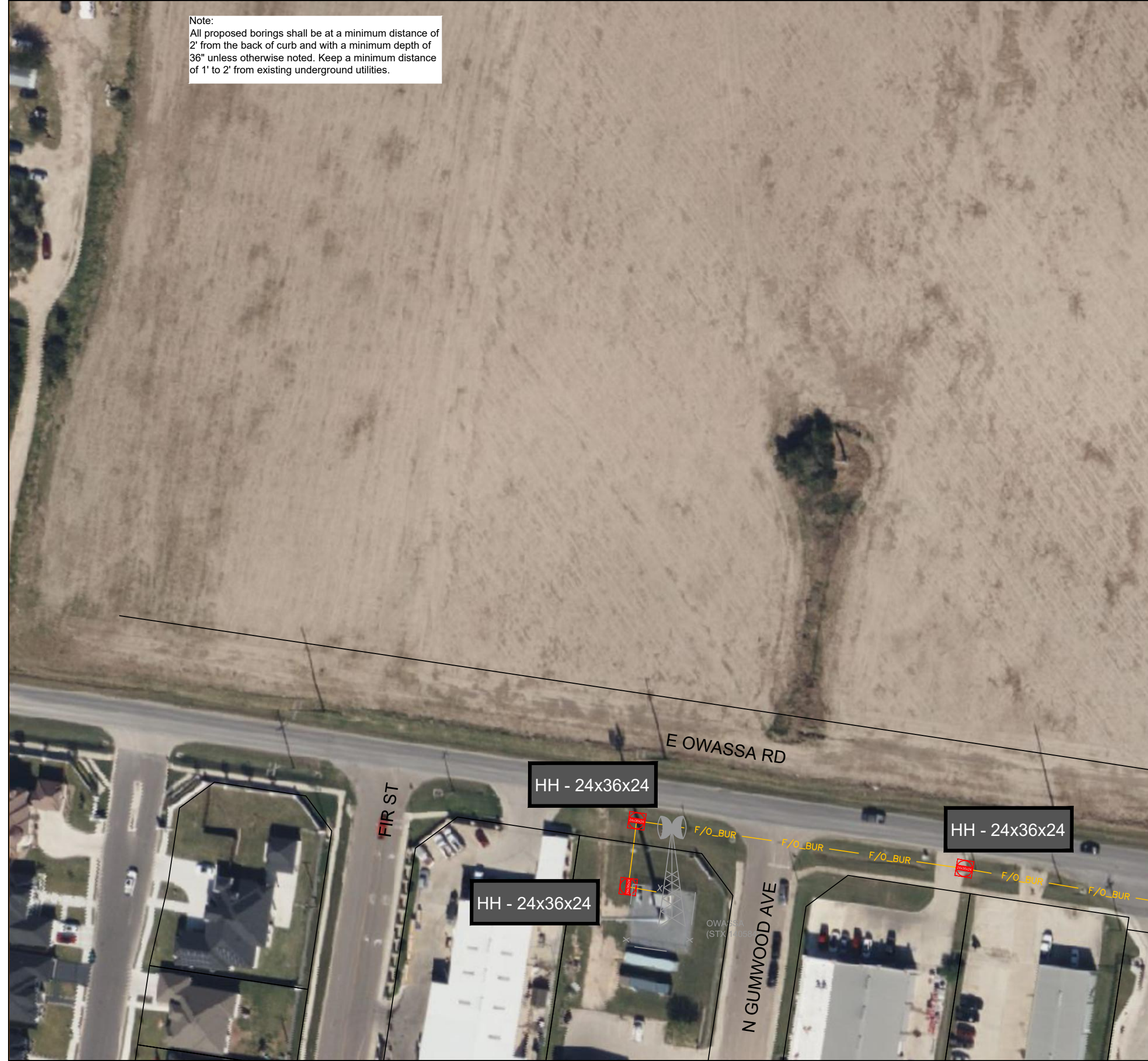
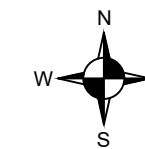





- | | | | |
|---|-------------------|---|-----------------|
|  | Active Cabinet |  | Passive Cabinet |
|  | Neighborhood |  | Handhole |
|  | Residential |  | Pole |
|  | Commercial |  | Parcel |
|  | Multi-Dwelling |  | Pedestal |
|  | Multi-Tenant Unit |  | Flower Pot |
|  | Duct 2.00" |  | Duct 1.25" |

For print on Tabloid (11x17) size paper or larger.

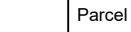
Disclaimer: Utility and property lines are shown for reference only. It is the Contractor's responsibility to validate the information to ensure no underground utilities are damaged and installed infrastructure is within public right-of-way.



Note:
All proposed borings shall be at a minimum distance of 2' from the back of curb and with a minimum depth of 36" unless otherwise noted. Keep a minimum distance of 1' to 2' from existing underground utilities.

- | | | | |
|---|-------------------|---|-----------------|
|  | Active Cabinet |  | Passive Cabinet |
|  | Neighborhood |  | Handhole |
|  | Residential |  | Pole |
|  | Commercial |  | Parcel |
|  | Multi-Dwelling |  | Pedestal |
|  | Multi-Tenant Unit |  | Flower Pot |
|  | Duct 2.00" |  | Duct 1.25" |

For print on Tabloid (11x17) size paper or larger.

Disclaimer: Utility and property lines are shown for reference only. It is the Contractor's responsibility to validate the information to ensure no underground utilities are damaged and installed infrastructure is within public right-of-way.

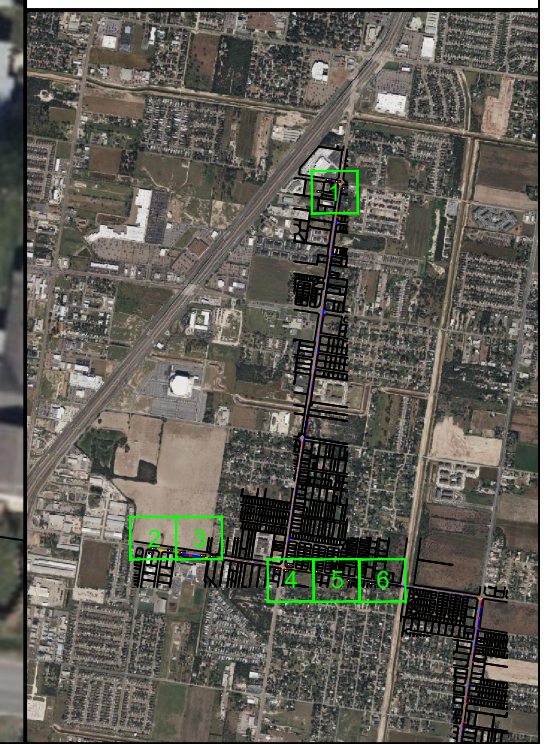
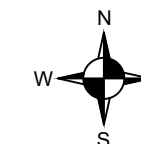

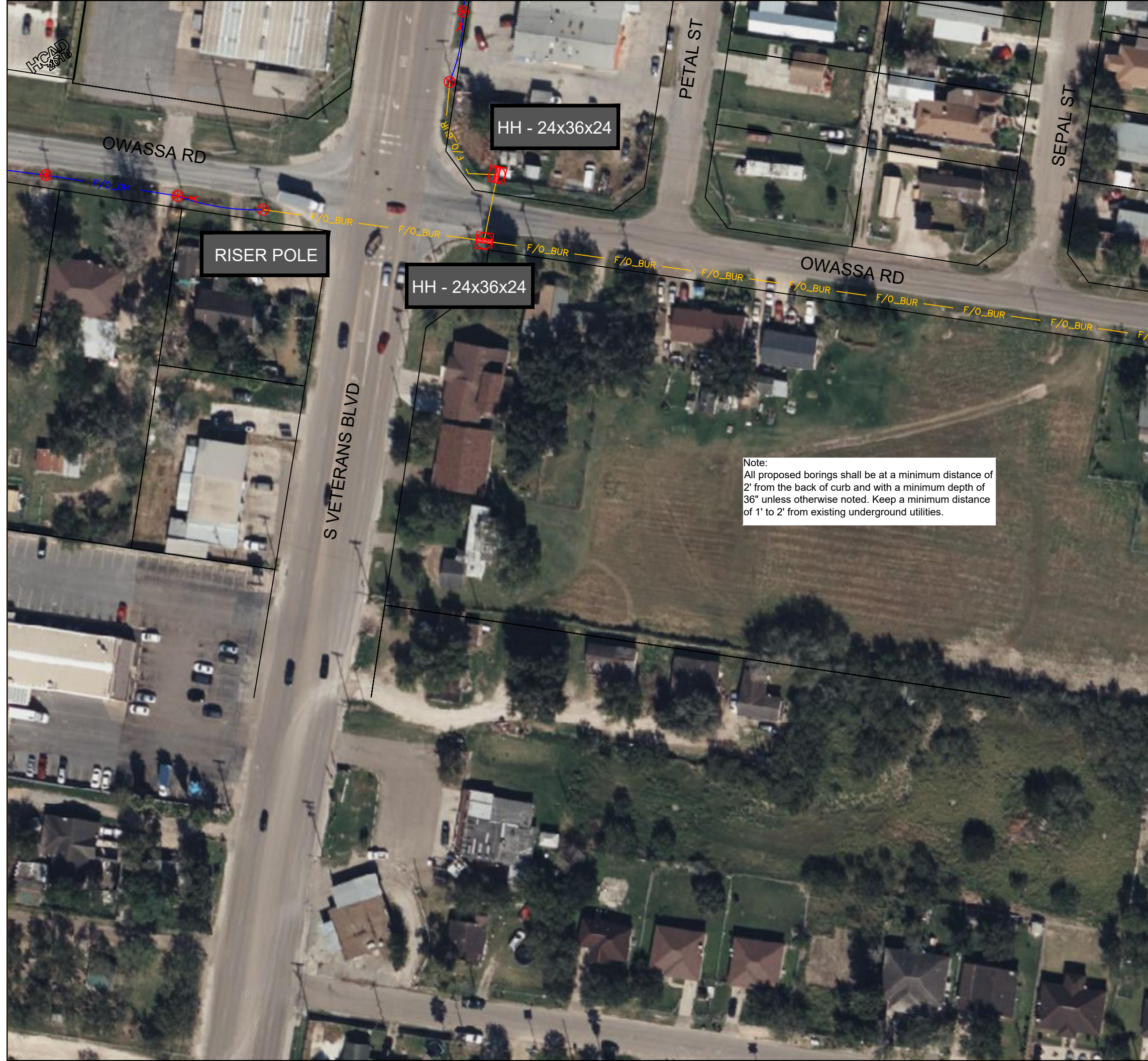

- | | | | |
|--|-------------------|--|-----------------|
| | Active Cabinet | | Passive Cabinet |
| | Neighborhood | | Handhole |
| | Residential | | Pole |
| | Commercial | | Parcel |
| | Multi-Dwelling | | Pedestal |
| | Multi-Tenant Unit | | Flower Pot |
| | Duct 2.00" | | Duct 1.25" |

For print on Tabloid (11x17) size paper or larger.

Note:
All proposed borings shall be at a minimum distance of 2' from the back of curb and with a minimum depth of 36" unless otherwise noted. Keep a minimum distance of 1' to 2' from existing underground utilities.

Disclaimer: Utility and property lines are shown for reference only. It is the Contractor's responsibility to validate the information to ensure no underground utilities are damaged and installed infrastructure is within public right-of-way.

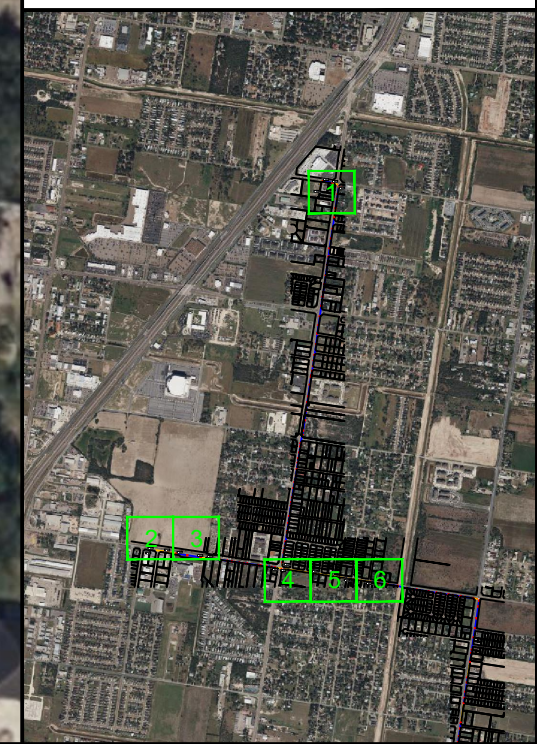
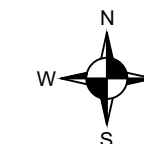



- | | | | |
|--|-------------------|--|-----------------|
| | Active Cabinet | | Passive Cabinet |
| | Neighborhood | | Handhole |
| | Residential | | Pole |
| | Commercial | | Parcel |
| | Multi-Dwelling | | Pedestal |
| | Multi-Tenant Unit | | Flower Pot |
| | Duct 2.00" | | Duct 1.25" |







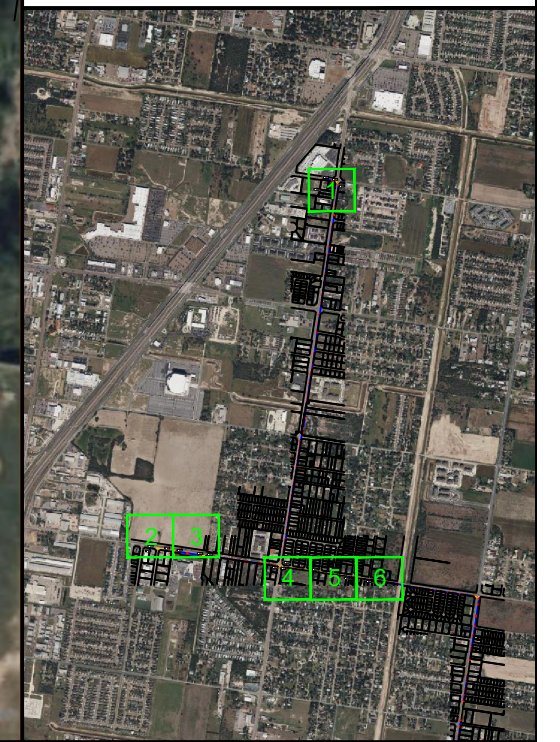
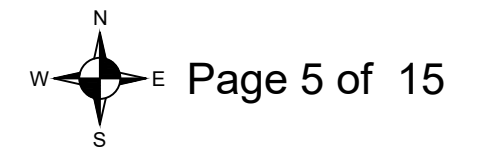







For print on Tabloid (11x17) size paper or larger.

Disclaimer: Utility and property lines are shown for reference only. It is the Contractor's responsibility to validate the information to ensure no underground utilities are damaged and installed infrastructure is within public right-of-way.

Note:
All proposed borings shall be at a minimum distance of 2' from the back of curb and with a minimum depth of 36" unless otherwise noted. Keep a minimum distance of 1' to 2' from existing underground utilities.



Note:
All proposed borings shall be at a minimum distance of 2' from the back of curb and with a minimum depth of 36" unless otherwise noted. Keep a minimum distance of 1' to 2' from existing underground utilities.

- | | | | |
|---|-------------------|---|-----------------|
|  | Active Cabinet |  | Passive Cabinet |
|  | Neighborhood |  | Handhole |
|  | Residential |  | Pole |
|  | Commercial |  | Parcel |
|  | Multi-Dwelling |  | Pedestal |
|  | Multi-Tenant Unit |  | Flower Pot |
|  | Duct 2.00" |  | Duct 1.25" |

For print on Tabloid (11x17) size paper or larger.

Disclaimer: Utility and property lines are shown for reference only. It is the Contractor's responsibility to validate the information to ensure no underground utilities are damaged and installed infrastructure is within public right-of-way.

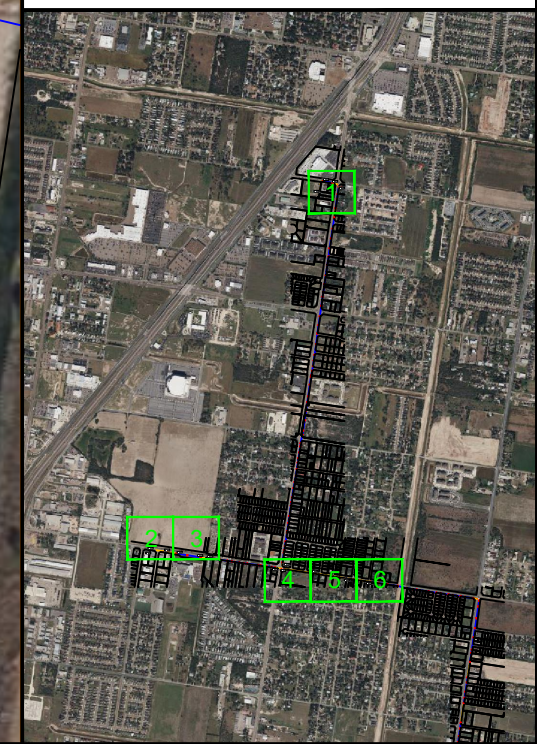
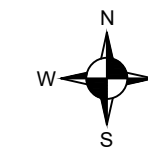

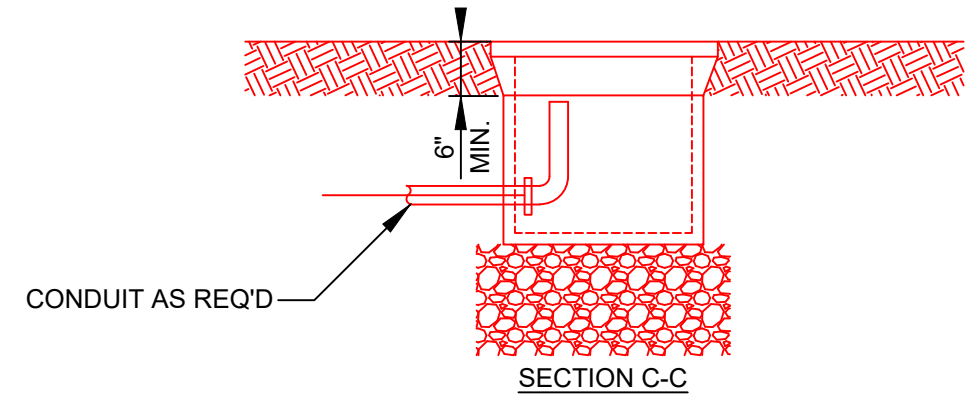
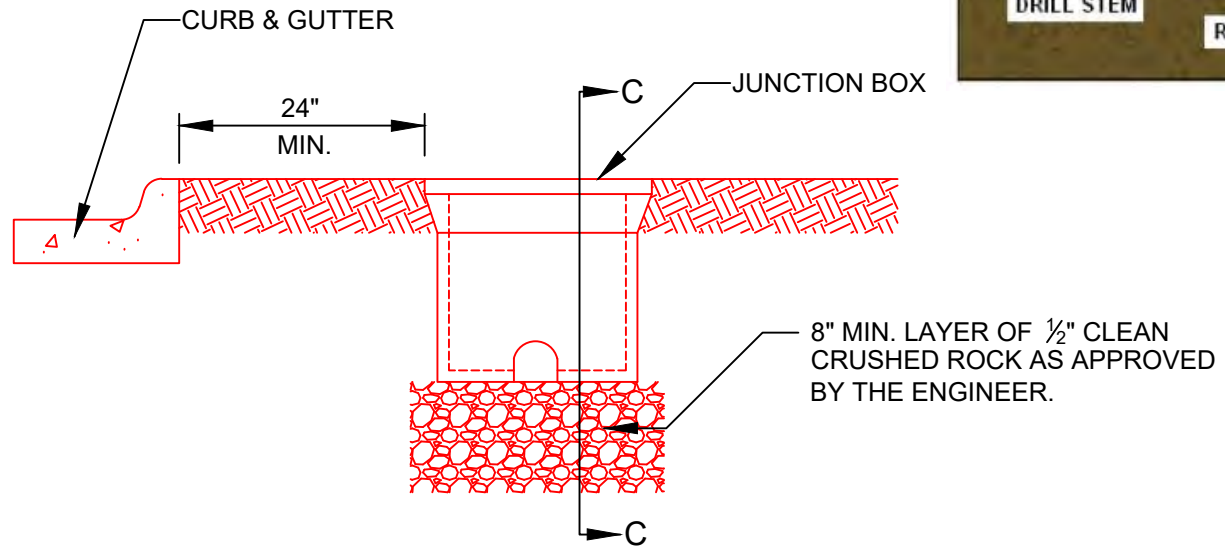
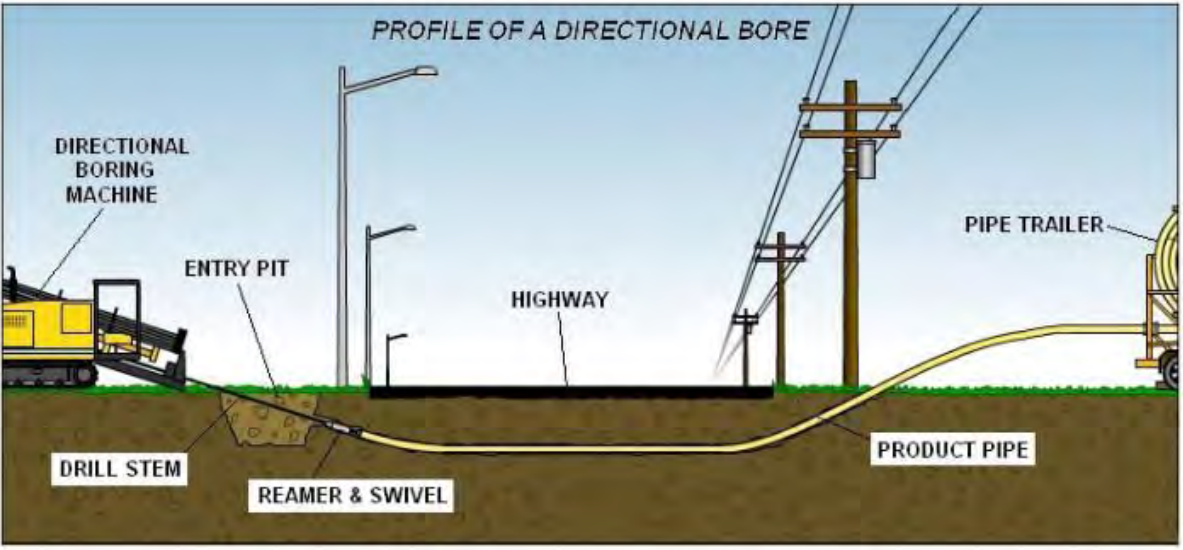

JUNCTION BOX INSTALLATION DETAIL
NOT TO SCALE

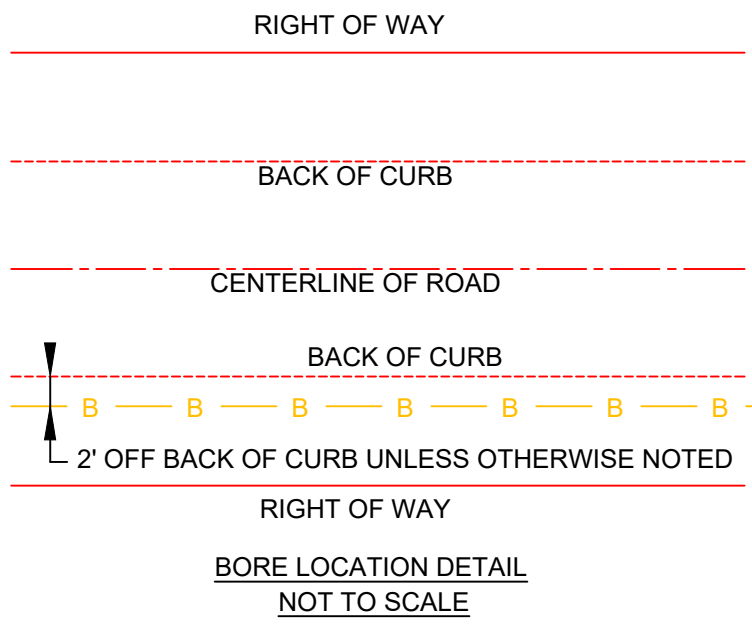

PRODESIGN
ENGINEERING

1295 Lourdes Rd
Metamora, IL 61548

DRAWN BY:	CHECKED BY:
	DMJ

SUBMITTALS		
DATE	DESCRIPTION	REV

PROJECT NO.

SHEET TITLE
DETAILS

ENGINEER STAMP

NOTES:

1. TYPICAL INSTALLATION OFFSET SHALL BE 5' WITHIN THE RIGHT-OF-WAY.
2. ALLEY CONSTRUCTION WILL BE PERFORMED BY CLOSING ALLEY WHILE CONSTRUCTION OCCURS WITH PROPER BARRICADES AND SIGNAGE.
3. ALL ROADWAY WORK SHALL FOLLOW TEXAS DOT MAINTENANCE OF TRAFFIC REQUIREMENTS.
4. DIRECTIONAL DRILLING SHALL BE UTILIZED AS DESIRED BY CONTRACTOR TO MINIMIZE IMPACT TO TREES AND HORTICULTURAL ELEMENTS.
5. APPLICANT SHALL NOTIFY ALL ADJACENT OR OTHERWISE AFFECTED PROPERTY OWNERS VIA DOOR HANGERS PRIOR TO COMMENCING WORK.

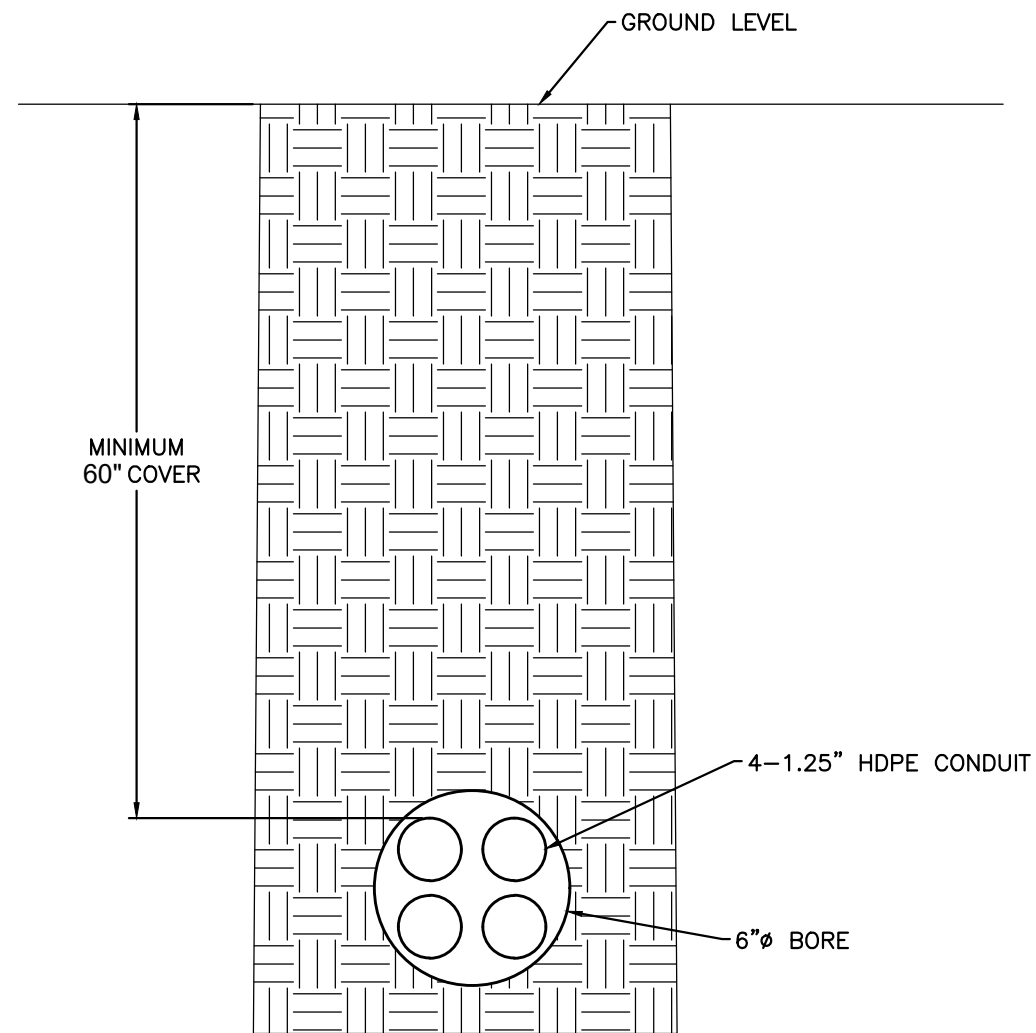

TYPICAL BORE DETAIL
NTS



1295 Lourdes Rd
Metamora, IL. 61548

DRAWN BY:	CHECKED BY:
	DMJ

SUBMITTALS		
DATE	DESCRIPTION	REV

TYPICAL BORE
DETAIL

PROJECT NO.

SHEET TITLE

ENGINEER STAMP

SHEET NUMBER
OF

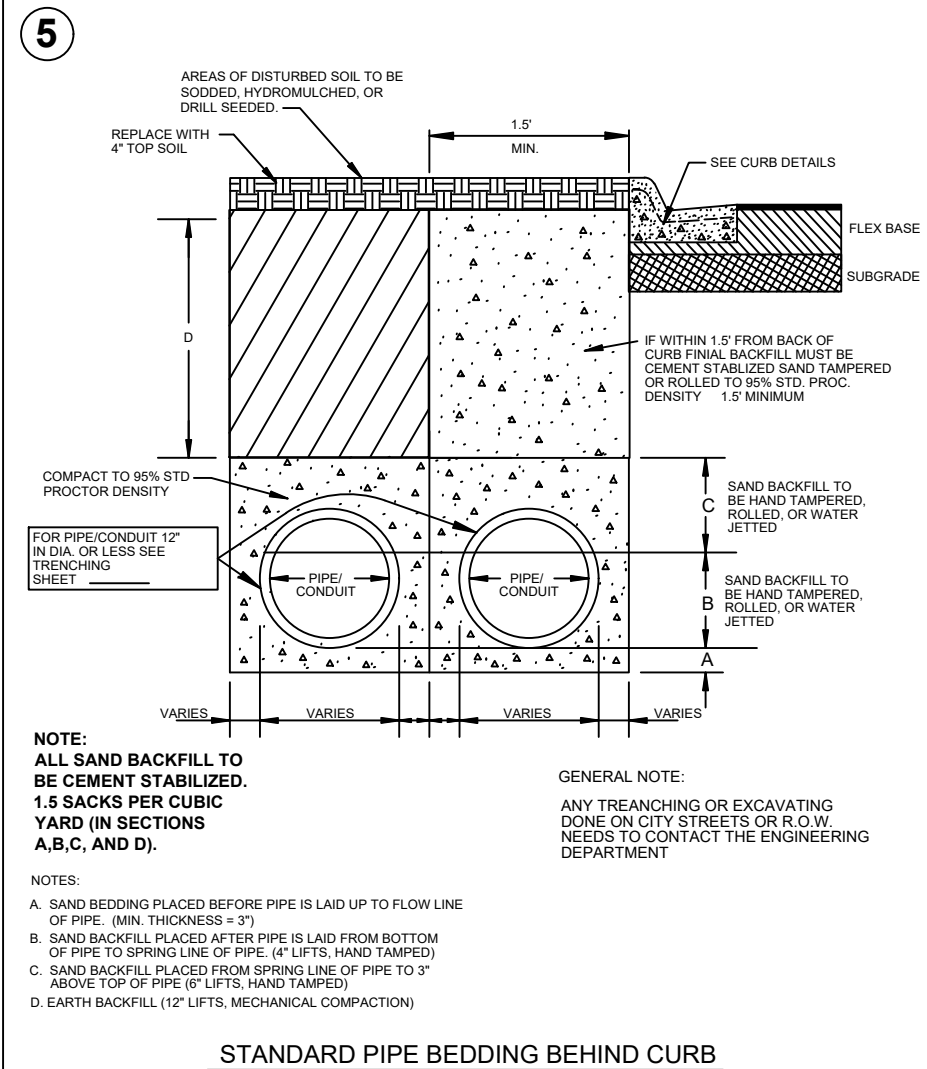
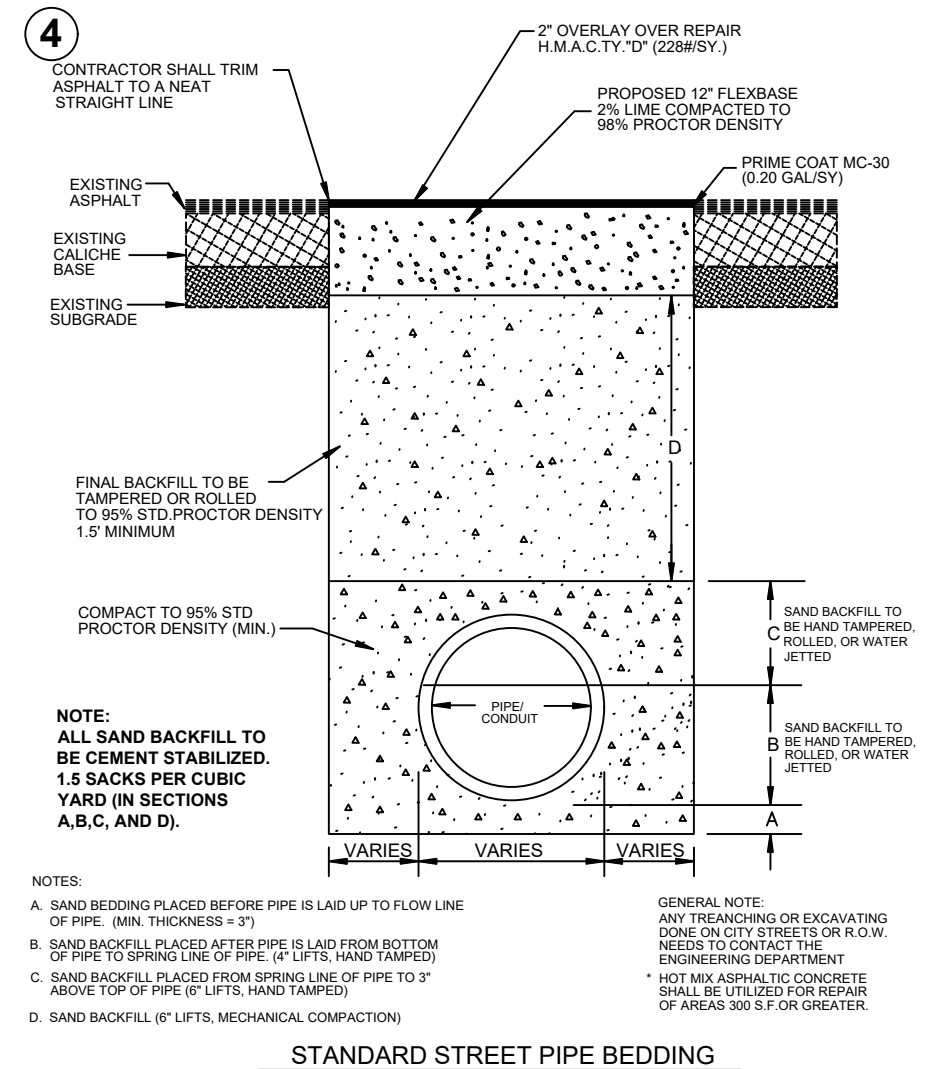
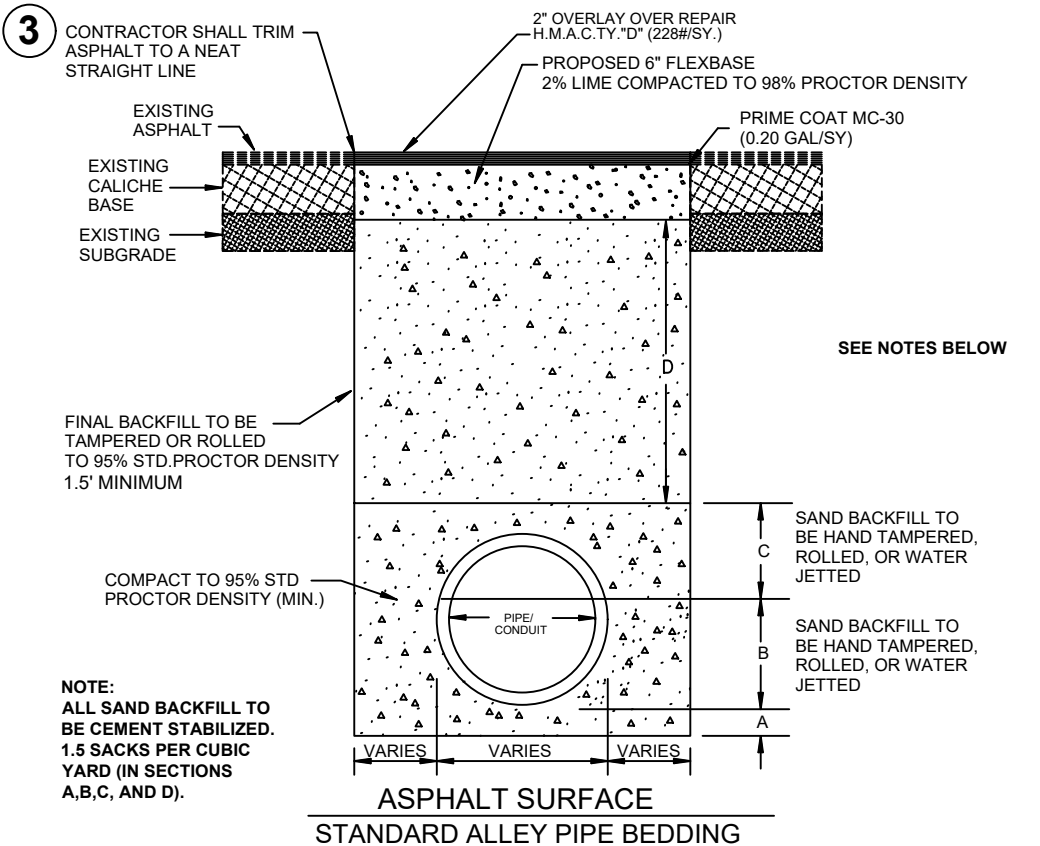
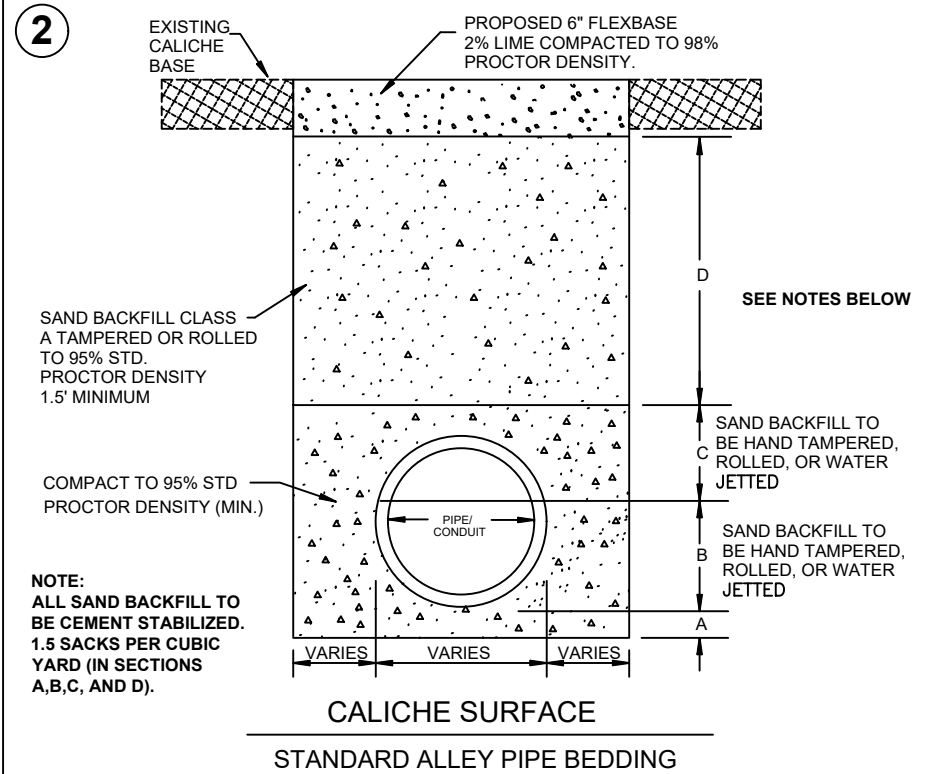
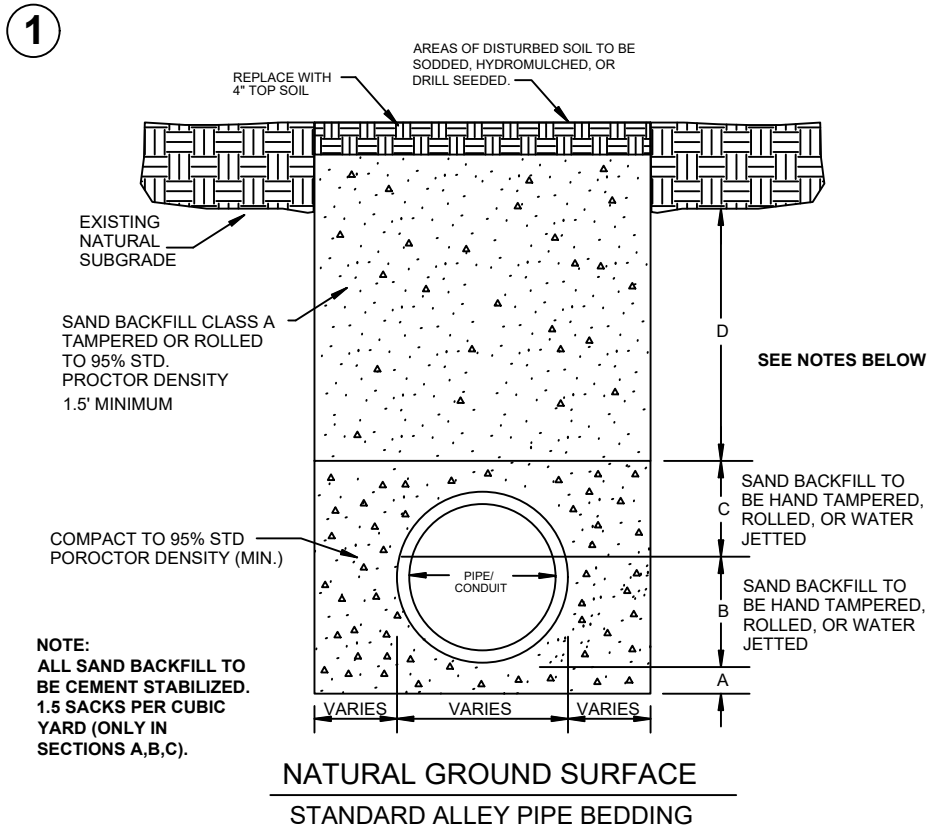

NOTES:

- SAND BEDDING PLACED BEFORE PIPE IS LAID UP TO FLOW LINE OF PIPE. (MIN. THICKNESS = 3")
- SAND BACKFILL PLACED AFTER PIPE IS LAID FROM BOTTOM OF PIPE TO SPRING LINE OF PIPE. (4" LIFTS, HAND TAMPED)
- SAND BACKFILL PLACED FROM SPRING LINE OF PIPE TO 3" ABOVE TOP OF PIPE (6" LIFTS, HAND TAMPED)
- SAND BACKFILL (6" LIFTS, MECHANICAL COMPACTION)

NOTE REGARDING CEMENT STABILIZED SAND BACKFILL: CEMENT STABILIZED SAND IS TO BE USED FOR TRENCHES WITHIN EXISTING ROADWAY SECTIONS OR AS SPECIFIED BY THE ENGINEER OR PLANS.

GENERAL NOTES:

- ANY TRENCHING OR EXCAVATING DONE ON CITY STREETS OR R.O.W. NEEDS TO CONTACT THE ENGINEERING DEPARTMENT
- * HOT MIX ASPHALTIC CONCRETE SHALL BE UTILIZED FOR REPAIR OF AREAS 300 S.F. OR GREATER.
- ALL SAND TO BE ARROYO SAND (200 WASH 100% PASSING)
- AREAS OF DISTURBED SOIL NOT WITH IN THE STREET OR ALLEY WAY TO BE SODDED, HYDROMULCHED, OR DRILL SEEDED.

NOTE: THE THICKNESS OF EXISTING ASPHALT, FLEXBASE, AND SUBGRADE VARIES.

PRODESIGN
ENGINEERING

ENGINEERING DEPARTMENT

STANDARD BACKFILL REQUIREMENTS

NOT TO SCALE

PROJECT NO.		FILE NO.	SHEET NO.
		city_backfill.dwg	
STATE	COUNTY	MONTH	YEAR
TEXAS			

APC 243624 Polymer Concrete Box & Cover

Cover View

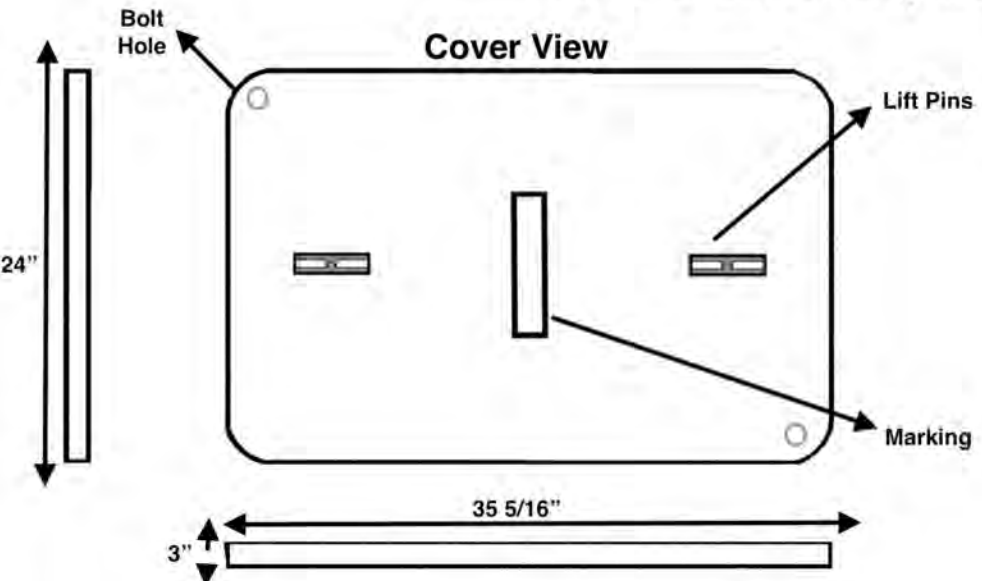

Top View

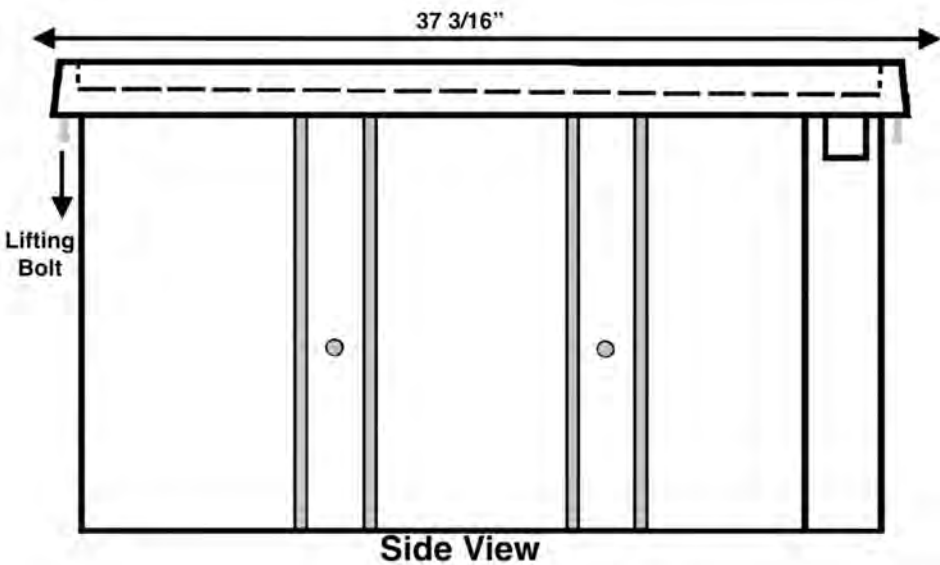
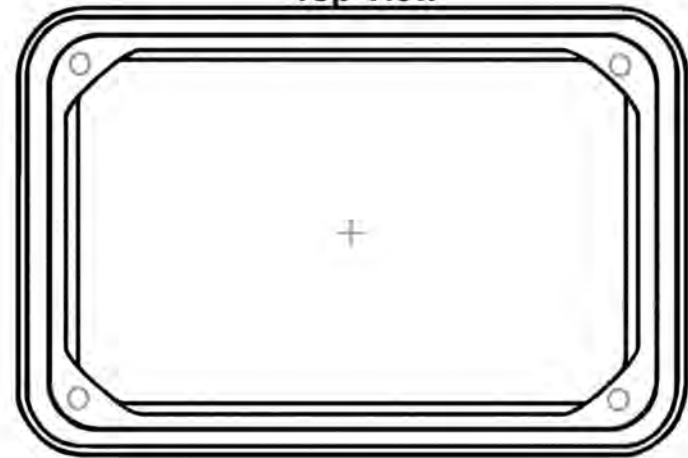

Side View

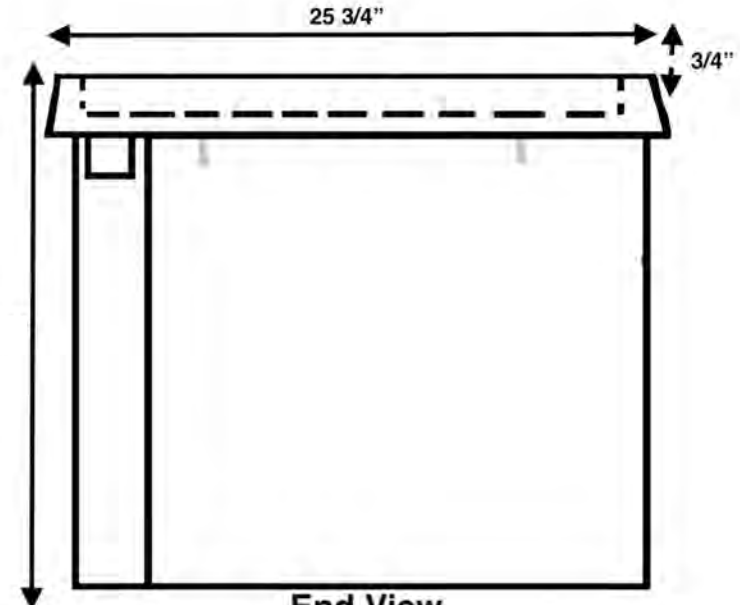

End View

JH American Enclosures
Made from over 30 years of experience

PO Box 330596
Fort Worth TX, 76163
jh_american@yahoo.com

Loading Requirements
Vertical
Design Load: 22,500 lbs
Test Load: 33,750 lbs

Lateral
Design Load: 800 lbs/sq. ft.
Test Load: 1,200 lbs/sq. ft.

Part No. APC243624
Body: Polymer Concrete
Cover: Polymer Concrete
Weight: 280lb Tolerance: +/- 1/8"
Material: Polymer Concrete
Standard Color: Gray
Tier 22

APC 304824 Polymer Concrete Box & Cover

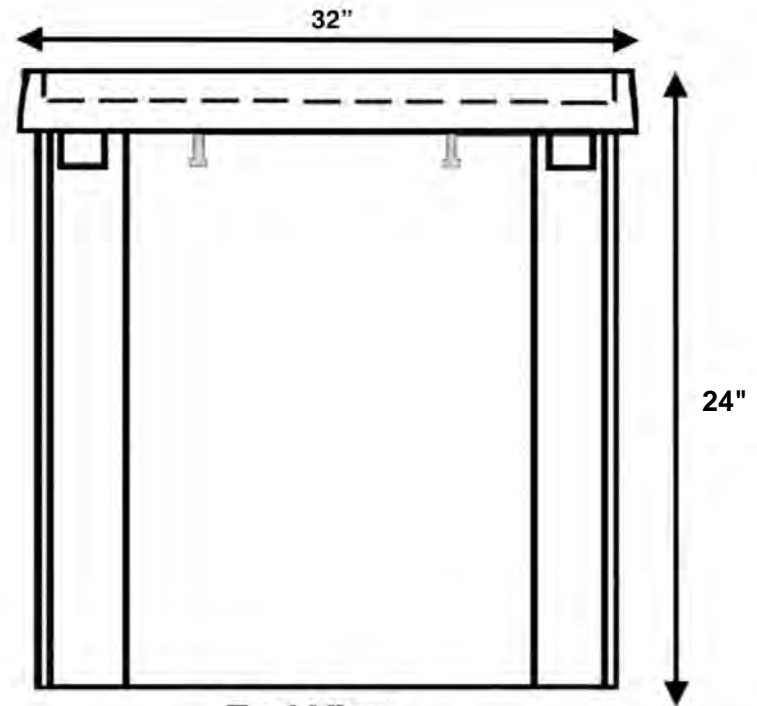
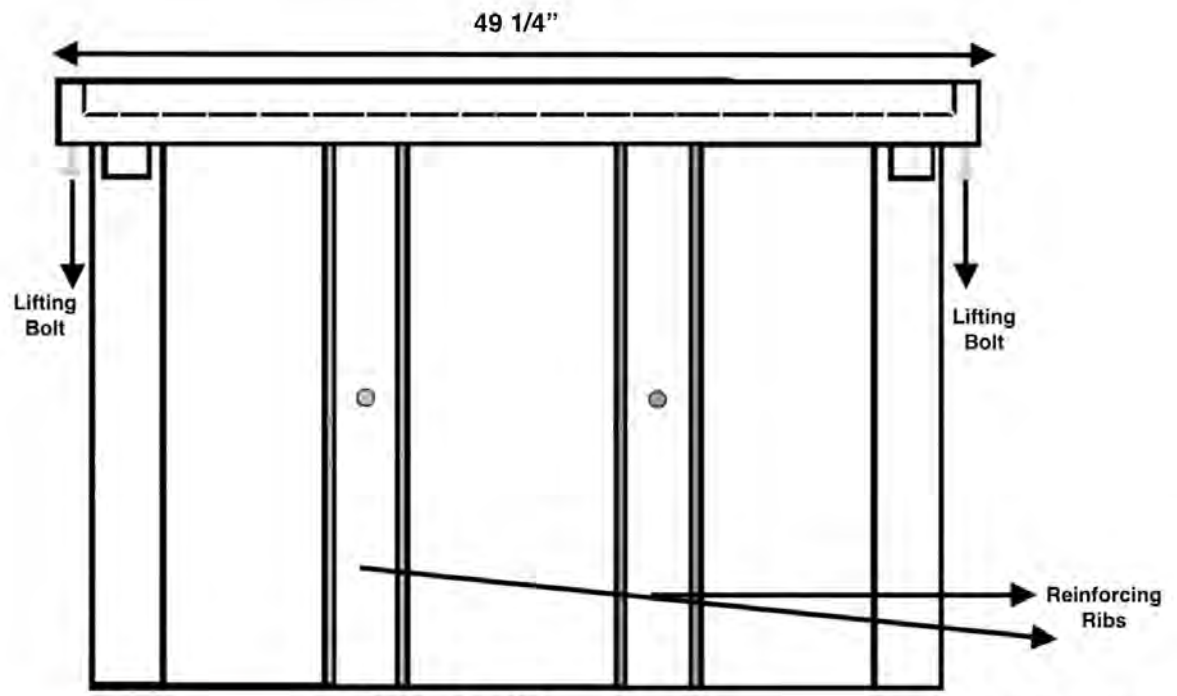
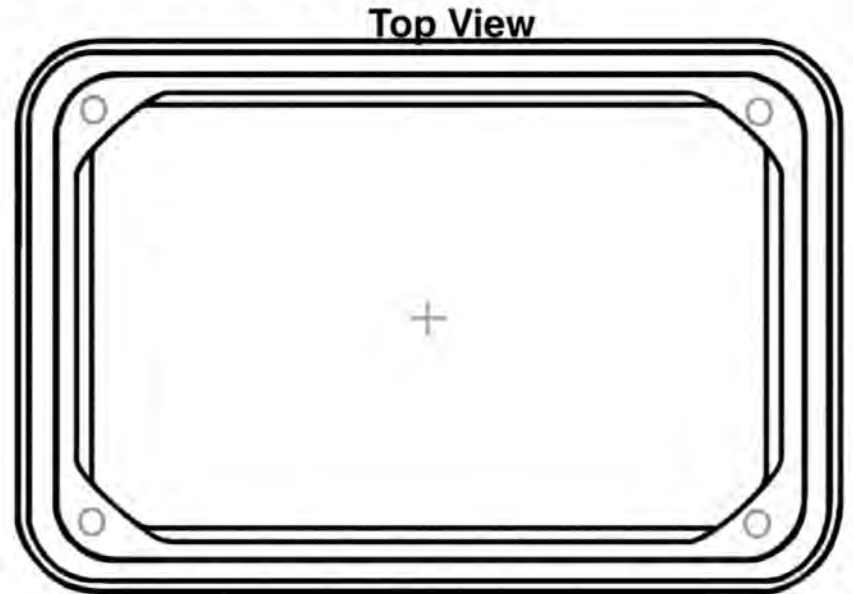
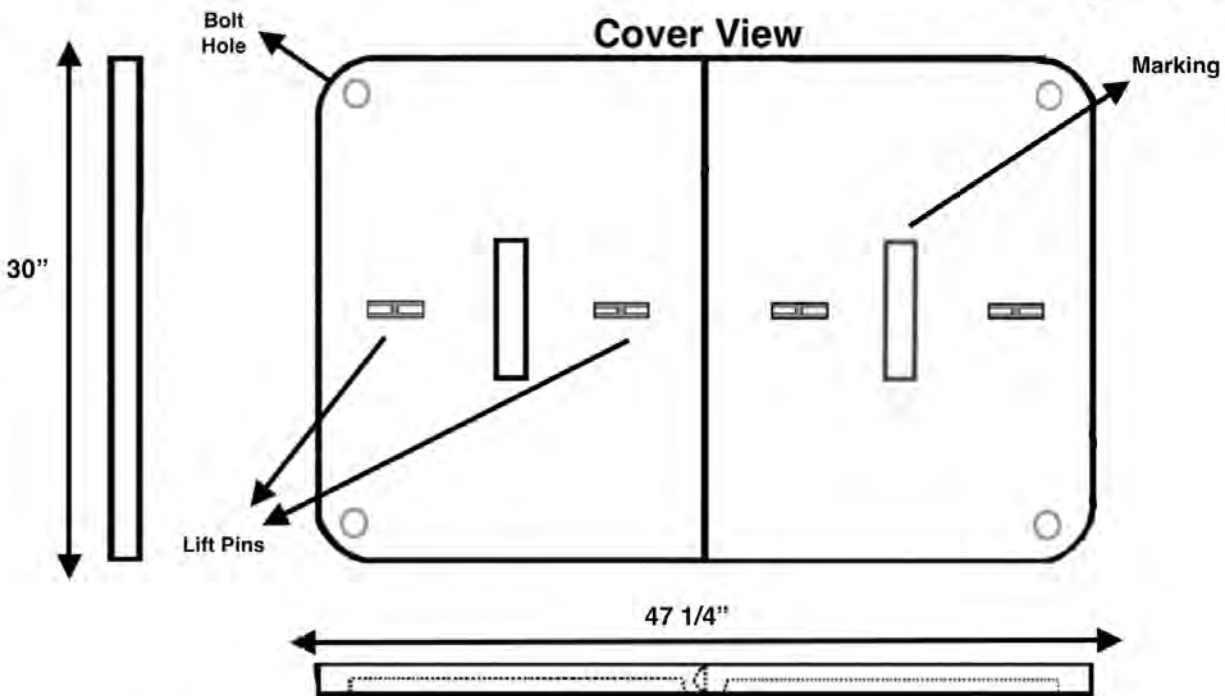

Loading Requirements
Vertical
Design Load: 22,500 lbs
Test Load: 33,750 lbs

Lateral
Design Load: 800 lbs/sq. ft.
Test Load: 1,200 lbs/sq. ft.

Part No. APC304824
Body: Polymer Concrete
Cover: Polymer Concrete
Weight: 640 lbs Tolerance: +/- 1/8"
Material: Polymer Concrete
Standard Color: Gray
Tier 22

JH American Enclosures
Made from over 30 years of experience

PO Box 330596
Fort Worth, TX 76163
jh_american@yahoo.com

APC 366036 Polymer Concrete Box & Cover 2 Piece Cover

Cover View

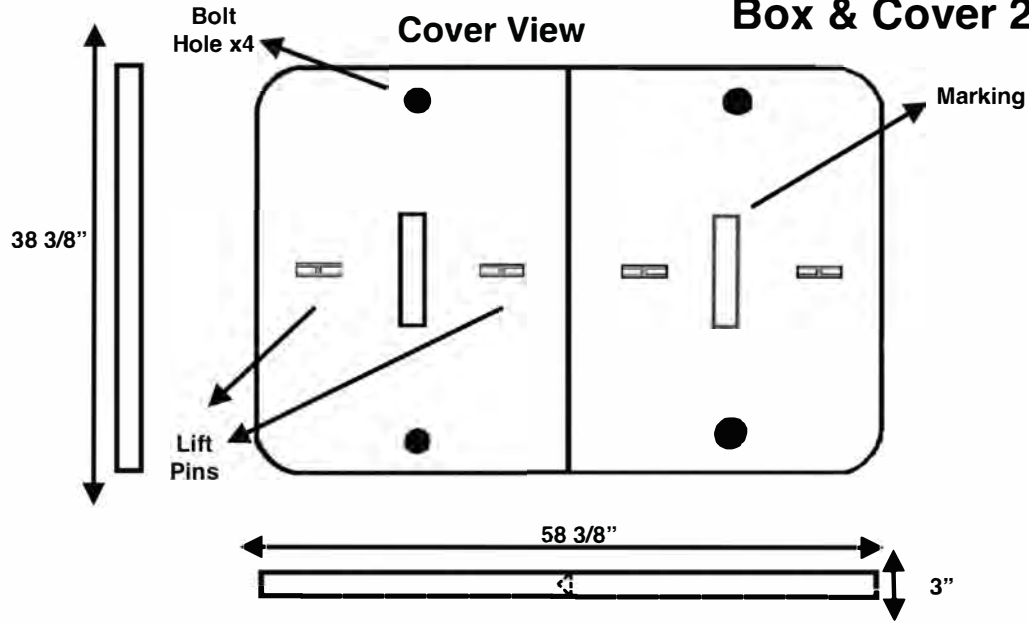

Top View

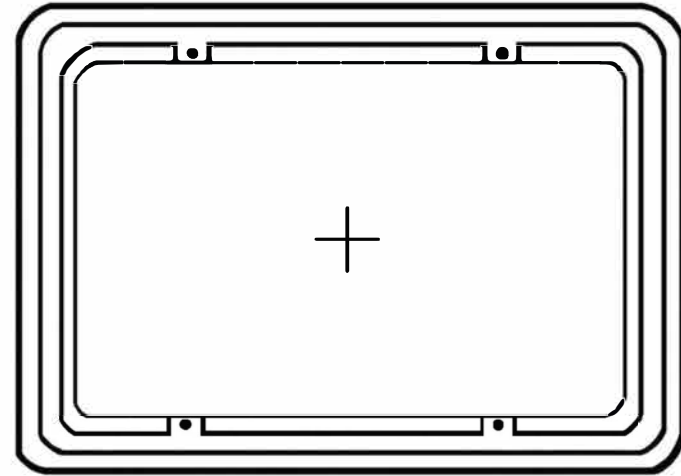

Side View

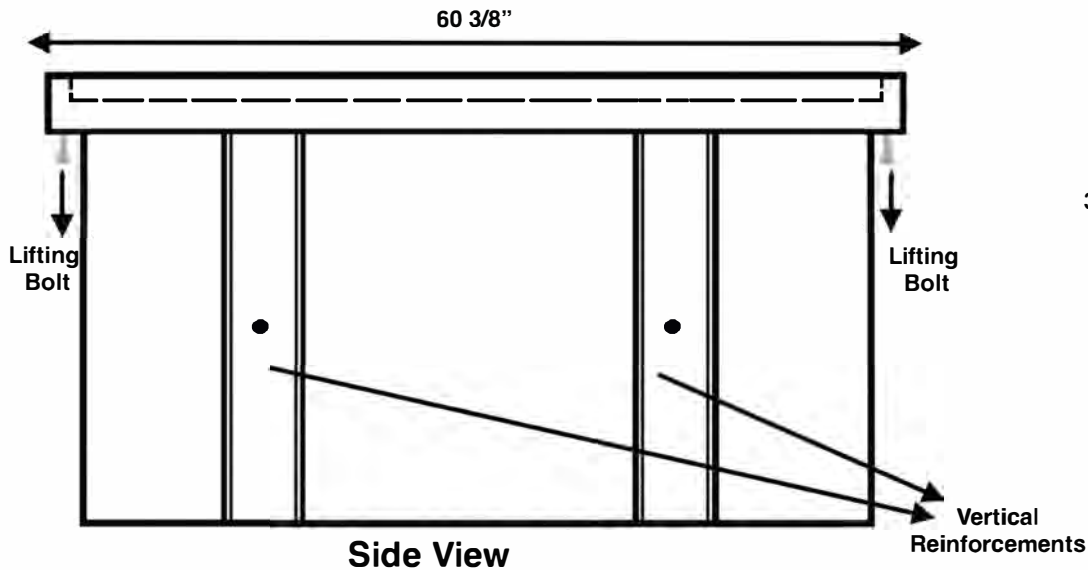

End View

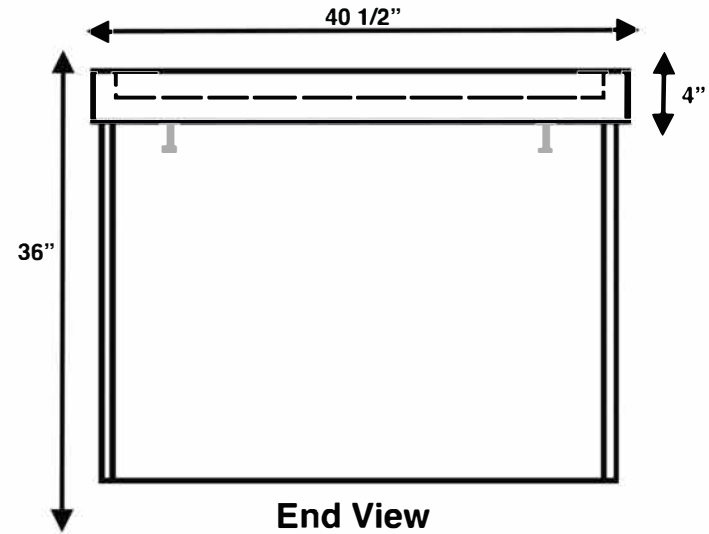

Part No. APC366036
Body: Polymer Concrete
Cover: Polymer Concrete
Weight: 822 lbs Tolerance: +/- 1/8"
Material: Polymer Concrete
Standrad Color: Gray
Tier 22

