

**REQUIREMENTS AGREEMENT  
C-19-100C-06-18**

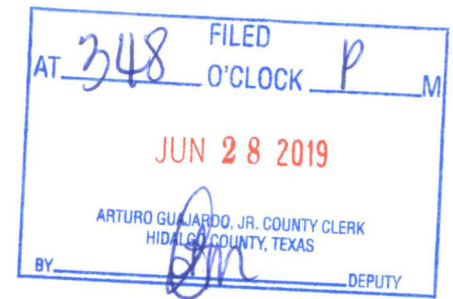

**THIS AGREEMENT** (the “Agreement”) is entered into effect as of the **18th** day of **June 2019** by and between **Act Pipe & Supply** (“Seller”) and Hidalgo County, Texas (Buyer”).

**WHEREAS**, Buyer has solicited sealed bids for the supply of its requirements of Hidalgo County for the “**Pipes & Related Miscellaneous Items**” (**on an as needed basis**) (the “Product”) for Hidalgo **County**, as further described in Exhibit “A”, Request for Bids (RFB) Procurement Packet as attached hereto and incorporated herein by reference for all purposes (the “RFB”); and

**WHEREAS**, Seller has submitted a proposal to supply Buyer’s requirements in accordance with the specifications as bid, a copy of Request for Bids (RFB) Procurement Packet and Proposal being attached hereto as Exhibits “A” and “B” respectively, and incorporated herein for all purposes (the “Specifications”);; and

**WHEREAS**, Buyer has determine that Seller has submitted the lowest and best bid to meet Buyer’s requirements for certain of the Products, as herein after described.

**NOW THEREFORE**, for and in consideration of the mutual covenants and conditions hereinafter set forth, and other good and valuable consideration, the receipt and sufficiency of which is hereby acknowledged, the parties hereto agree as follows:

1. Buyer agrees to purchase from Seller, and Seller agrees to sell and deliver to Buyer, all of the Products listed in Exhibit “B”, which is attached hereto and incorporated herein by reference, that Buyer may require for use by Buyer in Hidalgo County projects for a period of **one (1) year** with the County’s option to extend/renew for an additional one (1) year period under the same rates, terms and conditions. Hidalgo County reserves the right to continue this bid for an additional sixty (60) day grace period, under the same rates, terms and conditions at the end of the contract term for unforeseen delays in award of new bid for the next contract term. This Contract shall commence on **June 30, 2019** and expire on **June 29, 2020** and it is agreed that the Products will meet the Specifications in the Request of Bids (RFB) Procurement Packet set forth in Exhibit “A” hereto.

2. When Buyer determines that it needs a quantity of the Products to be delivered, it will according to its Purchasing Policies, complete and submit to Seller a Purchase Order describing the type and quantity of the Products required. The Products are to be delivered by Seller to the location in Hidalgo County specified by Buyer in its Purchase Order.

3. Buyer agrees to Pay Seller for each Purchase Order based on the prices set out in the Exhibit “B” Seller shall render invoices for each Purchase Order, and the invoices shall be paid by Buyer in accordance with the Texas Prompt Payment Act, Tex. Govt. Code Ch. 2251.

4. Seller represents that it is licensed by the State of Texas and qualified to perform and execute the services provided above. If such license is suspended or revoked, this Contract shall automatically be terminated and Seller shall immediately notify the County Judge of Hidalgo.

5. Seller must comply with all applicable laws and regulations of the State of Texas, and County policies. Notwithstanding the foregoing sentence, Seller represents and maintains that Seller is an independent Contractor and is not an employee of the County, or any agency thereof, and represents and warrants that Seller does not desire or request any fringe benefits provided to employees of County, and/or any agency of the County.

**6. Indemnification: Seller will indemnify and hold Buyer harmless from any and all claims, actions, liability, and expenses (including costs of judgments, settlements, court costs, and attorneys' fees, regardless of the outcome of such claim or action) caused by, resulting from, or alleging negligent or intentional acts or omissions or any failure to perform any obligation undertaken or any covenant in this Contract, whether such act, omission, or failure was the Seller's or that of any person providing services hereunder through or for the Seller. Upon written notice from the Buyer, the Seller will resist and defend at its own expense, and by counsel reasonably satisfactory to Buyer, any such claim or action. The Seller will carry proper insurance with the Buyer as an additional named insured.**

7. General Provisions.

- a. **Conflict with Applicable Law.** Nothing in this Agreement shall be construed so as to require the commission of any act contrary to law, and whenever there is any conflict between any provision of this Agreement and any present or future law, ordinance or administrative, executive or judicial regulation, order or decree, or amendment thereof, contrary to which the parties have no legal right to contract, the latter shall prevail, but in such event the affected provision or provisions of this Agreement shall be modified only to the extent necessary to bring them within the legal requirements and only during the time such conflicts exists.
- b. **No Waiver.** No waiver by Buyer of any breach of any provision of this Agreement shall be deemed to be a waiver of any preceding or succeeding breach of the same or any other provision hereof.
- c. **Entire Agreement.** This Agreement contains the entire contract between the parties hereto, and each party acknowledges that neither has made (either directly or through any agent or representative) any representations or agreements in connection with this Agreement not specifically set forth herein. This Agreement may be modified or amended only by agreement in writing executed by Buyer and Seller, and not otherwise.
- d. **Texas Law to Apply.** This agreement shall be construed under and in accordance with the laws of the State of Texas, and all obligations of the parties created hereunder are

performable in Hidalgo County, Texas. The parties hereby consent to personal jurisdiction in Hidalgo County, Texas.

- e. **Notice.** Except as may be otherwise specifically provided in this Agreement, all notices, demands, requests or communications required or permitted hereunder shall be in writing and shall either be (i) personally delivered against a written receipt, or (ii) sent by registered or certified mail, return receipt requested, postage prepaid and addressed to the parties at the addresses set forth below, or at such other addresses as may have been theretofore specified by written notice delivered in accordance herewith:

If to Buyer: Hidalgo County  
Attention: County Judge  
100 E. Cano, 2<sup>nd</sup> Floor  
Edinburg, Texas 78539

If to Seller: Act Pipe & Supply  
1004 N. Shary Rd.  
Mission, Tx. 7857226

Each notice, demand, request or communication which shall be delivered or mailed in the manner described above shall be deemed sufficiently given for all purposes as such time as it is personally delivered to the addressee or, if mailed, at such time as it is deposited in the United States mail.

- f. **Termination.** Buyer may terminate this Agreement at any time for any reason or no reason at all upon giving thirty (30) days written notice,
- g. **Additional Documents.** The parties hereto covenant and agree that they will execute such other and further instruments and documents as are or may become necessary or convenient to effectuate and carry out the terms of this Agreement.
- h. **Successors.** This Agreement shall be binding upon and inure to the benefit of the parties hereto and their respective heirs, executors, administrators, legal representatives, successors, and assigns where permitted by this Agreement.
- i. **Assignment.** This Agreement shall not be assignable.
- j. **Headings.** The headings and captions contained in this Agreement are solely for convenient reference and shall not be deemed to affect the meaning or interpretation of any provision or paragraph hereof.

- k. Gender and Number.** All pronouns used in this Agreement shall include the other gender, whether used in the masculine, feminine or neuter gender, and the singular shall include the plural whenever and as often as may be appropriate.
- l. Authority to Execute.** The execution and performance of this Agreement by Buyer and Seller have been duly authorized by all necessary laws, resolutions or corporate action, and this Agreement constitutes the valid and enforceable obligations of Buyer and Seller in accordance with its terms
- m. Insurance.** Seller agrees to provide liability insurance covering all activities, vehicles and persons connected with providing services under this Contract in an amount not less than the minimum amounts prescribed by the Texas Tort Claims Act. Seller shall name Buyer as an additional insured and shall furnish Buyer a certificate issued by the insurer (attached as Exhibit “C”) that such insurance is in full force and effect.
- n. Commitment of Current Revenues Only.** In the event that, during any term hereof, Buyer’s Commissioners Court does not appropriate sufficient funds to meet the obligations of Buyer under this Agreement, Buyer may terminate this Agreement upon ninety (90) days written notice to Seller. Buyer agrees, however, to use reasonable efforts to secure funds necessary for the continued performance of this Agreement. The parties intend this provision to be a continuing right to terminate this Agreement at the expiration of each budget period of Buyer. **Agreements for the acquisition, including lease of real or personal property under Tex. Loc. Govt. Code §271.903:** In the event that, during any term hereof, Buyer’s Commissioners Court does not appropriate sufficient funds to meet the obligations of Buyer under this Agreement, Buyer may terminate this Agreement upon ninety (90) days written notice to Seller. Buyer agrees, however, to use a best efforts attempt to obtain and appropriate funds for payment of the Agreement. The parties intend this provision, if applicable, to be a continuing right to terminate this Agreement at the expiration of each budget period of Buyer pursuant to the provisions of Tex. Loc. Govt. Code Ann. ‘271.903 (Vernon Supp. 1996).
- o. Purchasing Ethics.** Seller represents and warrants it has not, during the process of being awarded this contract violated the following ethical standards of Buyer and, upon and after the execution of this Agreement, agrees to abide by the following ethical standards of Buyer:
- (1)** It shall be a breach of ethics to offer, give or agree to give any elected official, department head or employee, or former elected official, department head or employee, of Hidalgo County, or for any elected official, department head or employee or former elected official, department head or employee of Hidalgo

County, to solicit, demand, accept or agree to accept from another person, entity or organization, a gratuity or an officer of employment in connection with any decision, approval, disapproval, recommendation, preparation or any part of a program requirement or purchase request,, influencing the content of any specification or procurement standard, rendering of advice, investigation, auditing, or in any other advisory capacity in any proceeding or application, request for ruling, determination, claim or controversy, or other particular matter pertaining to any program requirement or a contract or subcontract, or to any solicitation or proposal therefore pending before any department or agency of Hidalgo County.

(2) It shall be breach of ethics for any payment, gratuity or offer of employment to be made by or on behalf of a subcontractor under a contract to the prime contractor or higher tier subcontractor for any contract for Hidalgo County, or any person associated therewith, as an inducement for the award of a subcontract or order.

- p. Immunities.** Nothing in this Agreement is intended to and Buyer does not hereby waive, release or relinquish any right to assert any of the defenses Buyer enjoys by virtue of the state or federal constitution, laws rules or regulations, and any sovereign, official or individual against Buyer.
- q. Nondiscrimination:** Company, including subcontractors, assignees and successors in interest, ensures that no person shall on the grounds of race, religion, color, national origin, sex, age, disability, or any other protected class under law, be excluded from participation in, be denied the benefits of, or be otherwise subjected to discrimination or retaliation in any federally or non-federally program or activity when providing any services described herein under this contract/agreement. Applicable nondiscrimination statements and provisions of Title VI of the Civil Rights Act of 1964, as amended, were provided as part of the initial procurement packet and are incorporated herein and made part of this agreement for all purposes.
- r. Additional Documents:** The parties hereto covenant and agree that they will execute each such other and further instruments and documents as are or may become necessary or convenient to effectuate and carry out the terms of this contract/agreement.
- s. Required Contract Provision for Contracts Subject to Federal Award (if applicable):** Pursuant to 2 CFR 200.326, a non-federal entity's contracts must contain the applicable provisions described in Appendix II to 2 CFR 200-Contract Provisions for non-Federal Entity Contracts under Federal Awards. Additionally, County contracts under Federal award which are subject to assistance from the Federal

Emergency Management Agency (FEMA) are also required to contain additional contract clauses. The applicable required contract clauses were provided as part of the initial procurement packet and are incorporated herein and made part of this agreement for all purposes.

**EXECUTED** effective as of the day and year first above written.

COUNTY OF HIDALGO

**ATTEST:**   
  
Arturo Guajardo Jr., County Clerk

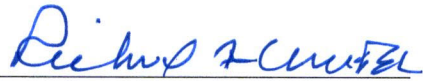
BY:   
Richard F. Cortez

APPROVED BY  
COMMISSIONERS' COURT  
ON: 6/18/19 

COMPANY: **Act Pipe & Supply**

BY:   
Printed Name: Jorge Zavala  
Title: Ops Manager / sales

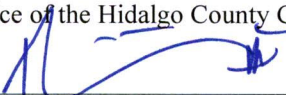
APPROVED AS TO FORM:  
Office of the Hidalgo County Criminal District Attorney  
BY:   
Robert Viña, III, Assistant District Attorney  
Civil Litigation Division

## **Exhibit "A"**

### **REQUEST FOR SEALED BIDS (RFB) PROCUREMENT PACKET**

**EXHIBIT "B"**

BID PAGE

**EXHIBIT "C"**  
**CERTIFICATE OF INSURANCE**



2812 S. Bus. Hwy 281  
Edinburg, Texas 78539  
Phone: (956) 318-2626  
Fax: (956) 318-2629  
[www.co.hidalgo.tx.us/purchasing](http://www.co.hidalgo.tx.us/purchasing)

April 29, 2019

\_\_\_\_\_  
Bidder's name

\_\_\_\_\_  
Address

\_\_\_\_\_  
City, State, Zip Code

Re: **RFB No.: 2019-100-05-15-TDL**  
HIDALGO COUNTY – (All funding sources, programs & entities)  
Request for Bid - **“Pipes & Related Miscellaneous Items”**

---

Dear Gentlemen/Ladies:

Enclosed, please find the Request for Bids (RFB) packet. **Modifications and new requirements** have been added and implemented. Carefully read and review all instructions, Requirements and Specifications.

Hidalgo County Purchasing Department welcomes and appreciates your participation in the Request for Bids process.

If any further assistance is required, please do not hesitate to call the Purchasing Department (956) 318-2626 ext. 4878

Sincerely,

Martha L. Salazar, CPPB  
Hidalgo County Purchasing Agent

MLZ/tdl  
Enclosures

## TABLE OF CONTENTS

### REQUEST FOR BID (RFB) HIDALGO COUNTY

(All funding sources, programs & entities)  
“PIPES & RELATED MISCELLANEOUS ITEMS”

#### RFB Bid No: 2019-100-05-15-TDL

ITEM	DESCRIPTION	NO. OF PAGES
1.	Request for Bids Letter	1
2.	Request for Bids, Table of Contents	1
3.	Request for Bids, Legal Notice	11
4.	Exhibit A, Requirements	8
5.	Exhibit B, Evaluation Criteria / Attachment B- Procurement Form	1
6.	Exhibit C, Insurance Requirements, Insurance/Project Acknowledgement Forms	4
7.	Exhibit D, (CIQ) Conflict of Interest Questionnaire	2
8.	Exhibit E, Vendor/Bidder Application, W-9, & HUB/DBE	9
9.	Exhibit F, Certification Regarding Debarment	1
10.	Exhibit G, Title VI Appendices “A” through “E”	6
11.	Exhibit H, Required Contract Clauses for Contracts Under Federal Award (if applicable)	15
12.	Exhibit I, FHWA1273	13
13.	Exhibit J, Proposer’s Affidavit	1
14.	RFQ Submittal Checklist	1

The above-mentioned items shall be found in this Request for Qualifications-RFQ packet that is attached herewith. Should you find that any of the listed items are not attached in its entirety, please contact Purchasing by calling (956) 318-2626 or e-mail, to advise us of the missing documentation, and Purchasing will forward information either through facsimile, e-mail or by U.S. Mail.

Thank you.

  
Martha L. Salazar, CPPB, Purchasing Agent

April 29, 2019  
Date



**REQUEST FOR BIDS (RFB)**

**HIDALGO COUNTY**

All funding sources, programs & entities

***“Pipes & Related Miscellaneous Items”***

**RFB No.: 2019-100-05-15-TDL**

Acceptance Due Date: **May 15, 2019**

Martha L. Salazar, CPPB, Purchasing Agent  
Hidalgo County Purchasing Department

Project Information:

Tanya De Lira, Contract Specialist II  
(956) 318-2626 Ext. 4878  
[tanya.delira@co.hidalgo.tx.us](mailto:tanya.delira@co.hidalgo.tx.us)

1. Sealed Bids will be received for **Hidalgo County** (All funding sources, programs & entities) **“Pipes & Related Miscellaneous Items”** in accordance with the requirements attached hereto as Exhibit "A." Bids should address all requirements set forth. Respondents (may also be referred to as bidder, contractor or vendor) may suggest substitutions of features which they feel would be in the best interest of Hidalgo County ("County"). A strong rationale must be presented for any deviation from the requirements. Hidalgo County reserves the right to reject the deviation and its effect on the overall bids.
2. One (1) original (pages one-sided, clearly marked ORIGINAL), one (1) copy and one (1) USB/CD of all bids are required with the respondent's name and address clearly typed/printed on upper left-hand corner and the proper notation clearly typed/printed on the lower left-hand corner of the envelope and/or package, **RFB No.: 2019-100-05-15-TDL Hidalgo County – “Pipes & Related Miscellaneous Items”**, and in County's Purchasing Department, Physical Location: 2802 S. Business Hwy. 281 Postal Mailing: 2812 S. Business Hwy. 281 Administration Building, Edinburg, Texas, **ON OR BEFORE 9:30 A.M., Wednesday, May 15th, 2019.**

**NO FACSIMILES OR LATE ARRIVALS WILL BE ACCEPTED. ANY QUALIFICATION RECEIVED AFTER THAT TIME WILL NOT BE OPENED AND WILL BE RETURNED. OVERNIGHT MAIL MUST ALSO BE PROPERLY LABELED ON THE OUTSIDE OF EXPRESS ENVELOPE OR PACKAGE IN REFERENCE TO QUALIFICATION.**

Hidalgo County reserves the right to refuse and reject any/all bids and to waive any/all formalities or technicalities or to accept the proposal considered the best and most advantageous to Hidalgo County.

Additionally, all forms listed below must be properly executed and included with your RFB:

1. Legal Notice (See page 11);
  2. Insurance pages with Acknowledgment Forms (See Exhibit “C”);
  3. Form CIQ-Conflict of Interest Questionnaire (See Exhibit “D”);
  4. Vendor Bidder Application & W-9 (See Exhibit “E”);
  5. Certification Regarding Debarment (See Exhibit “F”);
  6. (If applicable) – Required Contract Clauses for Contracts Under Federal Award – 2 CFR 200, Appendix II & FEMA (See Exhibit “H”);
  7. Proposer’s Affidavit (See Exhibit “J”); and
  8. SAMS.gov Registration Acknowledgement (See Number 17 below).
3. Hidalgo County reserves the right to separate and accept or eliminate any item(s) listed under this qualification that it deems necessary to accommodate budgetary and/or operational requirements. Hidalgo County also reserves the right to reject any or all bids submitted and further reserves the right to design the evaluation criteria to be used in selecting the lowest and best qualification for approval. Receipt of any bid shall under no circumstances obligate County to accept the lowest dollar bid. The award of this contract shall be made to the responsible offeror whose qualification is determined to be the best evaluated offer resulting from negotiation, taking into consideration the relative importance of price and other evaluation factors as herein set forth.
  4. Failure of the delivered item to perform as specified or failure to meet the stated delivery schedule shall release Hidalgo County from all obligations to the contracting party with regard to the item(s) in question. In such event, County may elect to award the contract to the next-lowest responsible respondent or to reject all bids and re-advertise.

5. For work to be performed at a County owned or operated location, each respondent shall, in its sole discretion, visit the job site before preparing the qualification and thoroughly familiarize himself/herself with existing conditions. Respondent should take field dimensions and note all circumstances which affect the dollar amount of the qualification.
6. Descriptive specifications are referenced in this document to indicate the general kind and quality of equipment desired by Hidalgo County. Due to various styles and models of equipment, respondents are required to include illustrations, specifications, explanation of warranties, and service data with their qualification including catalog numbers and any necessary references.
7. Proposed prices are to remain firm for a minimum of ninety (90) days after priced qualification opening.
8. County reserves the right to accept or reject any or all bids.
9. Any interpretations, amendments, corrections or changes to this qualification document must be in a written addendum and signed by the County Judge or his designee. Addenda will be mailed to all who are known to have received a copy of the Request for Bids. Respondents shall acknowledge receipt of all addenda as a part of their bid.
10. Costs are to be net F.O.B., County Prepaid.
11. The county is exempt from Federal Excise Tax, State Tax, and Local Tax. DO NOT include tax in cost figure. If it is determined that tax was included in the cost figure it will not be included in the tabulation of any awards. Tax exemption certificates will be furnished upon request.
12. Funds for this procurement have been provided through the County budget for this fiscal year only. County, on an annual basis, has the right to reconsider a contract during the budget process for ensuing years if financial resources of County are insufficient to meet the liabilities of said contract. The award of a qualification or contract hereunder will not be construed to create a debt of the County which is payable out of funds beyond the current fiscal year.
13. **DELIVERY INSTRUCTIONS:**
  - No deliveries accepted after 3:00 P.M., Monday-Friday.
  - At least seventy-two (72) hours prior notice of delivery must be given to Martha L. Salazar, CPPB, Purchasing Agent before delivery will be accepted.
  - If you need additional information call the office listed below:

Hidalgo County Purchasing Department  
Martha L. Salazar, CPPB, Purchasing Agent  
(956) 318-2626
14. **BILLING AND PAYMENT INSTRUCTIONS:**
  - Invoices must include:
    - a) Name and address of successful respondent

- b) Name and address of receiving department or official
- c) Purchase Order Number and Contract number (if any)
- d) Notation - **Hidalgo County RFB No.: 2019-100-05-15-TDL - HIDALGO COUNTY "Pipes & Related Miscellaneous Items"**.
- e) Descriptive information as to the items or services delivered, including product code, item number, quantity, etc.

- Discount payments will be considered when offered.
- Contact person for Billing and Payment questions:

**HIDALGO COUNTY AUDITOR'S OFFICE**  
 Postal/Mailing 2808 S. Business Hwy. 281  
 Edinburg, Texas 78539  
 956-318-2511

**15. SCHEDULE OF EVENTS**

Qualification Opening, 9:30 A.M.	<b>May 15, 2019</b>
Award of Contract:	2019
Commence Work or Deliver Products:	2019

**16. HIDALGO COUNTY HOLIDAYS:**

2019 YEAR	
New Year's Day	01/01/19
Martin Luther King Day	01/21/19
President's Day	02/18/19
Good Friday	04/19/19
Memorial Day	05/27/19
Independence Day	07/04/19
Labor Day	09/02/19
Columbus Day	10/14/19
Veteran's Day	11/11/19
Thanksgiving Day	11/28/19-11/29/19
Christmas Day	12/24/19-12/25/19
New Year's Eve	12/31/19

**17. BID OR PERFORMANCE BOND AND DEBARMENT CERTIFICATION; PAYMENT UNDER CONTRACT:**

- If the contract proposed is for the construction of public works or is for a contract for goods and services exceeding \$100,000, all bidders shall furnish a good and sufficient bid bond in the amount of five percent of the total contract price. A bid bond must be executed by a surety company authorized to do business in Texas.
- Together with the signing of a contract or issuance of a purchase order following the acceptance of qualification, and prior to the commencement of the actual work, the respondent shall furnish a performance bond to the County for the full amount of the contract, if that contract exceeds \$50,000.
- If the contract is for \$50,000 or less, no money will be paid to the contractor until completion and acceptance of the work or the fulfillment of the purchase obligation to the County, and, if applicable, the receipt by County of satisfactory evidence that all subcontractors and materialmen have been paid.
- If a contract is for the construction, alteration or repair of public buildings or public works, the contractor *shall* provide a payment bond for a contract in excess of Twenty-Five Thousand Dollars (\$25,000.00), as required by Tex. Govt. Code Ch. 2253.
- For requirements contracts, bond requirements are determined by applying the proposed unit price to the estimated quantities included in the specifications.
- All respondents are also required to furnish a certification or acknowledgment stating that the contractor or vendor is free from suspension or debarment pursuant to federal regulation 45CFR76. Register at SAMs System for Award Management @ [www.sam.gov](http://www.sam.gov).

**18. TITLE VI NOTICE/ NONDISCRIMINATION**

- a) By submitting a bid, the bidder certifies that it will comply with the following nondiscrimination statutes and their implementing regulations. Title VI of the Civil Rights Act of 1964, as amended (78 Stat.252, 42 U.S.C. §§2000d to 2000d-4) provides that no person in the United States shall, on the grounds of race, color, or national origin, be excluded from participation in, be denied the benefits of, or be otherwise subjected to discrimination under any program or activity for which the Recipient receives Federal financial assistance. Title VI has been broadened by related statutes, regulations and executive orders as found in Appendices "A" through "E" as delineated in the USDOT Standard Title VI/Non-Discrimination Assurances and disability. (Title VI-Appendices "A" through "E" are hereby attached as **Exhibit "G"**. The County's entire Title VI policy may be found at <https://www.hidalgocounty.us/2071/Title-VINondiscrimination-Plan> and is hereby incorporated by reference.
- b) The following required statement and the applicable provisions of the Title VI Appendices "A" through "E" expanding these protections to the categories described herein are hereby incorporated by reference as applicable.
  - "The County of Hidalgo, in accordance with the provisions of Title VI of the Civil Rights Act of 1964 (78 Stat.252, 42 U.S.C. §§2000d to 2000d-4) and the Regulations, hereby notifies all bidders that it will affirmatively ensure that any contract entered into pursuant to this advertisement, disadvantaged

business enterprises will be afforded full and fair opportunity to submit bids in response to this invitation and will not be discriminated against on the grounds of race, color, or national origin in consideration for an award".

- c) The bidder will attach all applicable notices, including those referenced in Title VI – Appendices "A" through "E", to which it is obligated to provide or submit as part of the bid.

If applicable, Form FHWA 1273 – "*Required Contract Provisions Federal-Aid Construction Contracts*", must be physically attached to certain Federal-aid construction contracts. A contractor (or subcontractor) is required to insert Form FHWA 1273 in each subcontract and all lower tier subcontracts. Form FHWA 1273 is attached as **Exhibit "I"**, and, if applicable, its provisions are incorporated in and made part of the contract entered into between the County and the successful respondent related to the present procurement.

#### 19. ETHICAL STANDARDS:

- It shall be a breach of ethics to offer, give or agree to give any elected official, department head or employee, or former elected official, department head or employee, of the County, or for any elected official, department head or employee or former elected official, department head or employee of the County, to solicit, demand, accept or agree to accept from another person, entity or organization, a gratuity or an offer of employment in connection with any decision, approval, disapproval, recommendation, preparation or any part of a program requirement or purchase request, influencing the content of any specification or procurement standard, rendering of advice, investigation, auditing, or in any other advisory capacity in any proceeding or application, request for ruling, determination, claim or controversy, or other particular matter pertaining to any program requirement or a contract or subcontract, or to any solicitation or qualification therefore pending before any department or agency of the County.
- It shall be a breach of ethics for any payment, gratuity or offer of employment to be made by or on behalf of a subcontractor under a contract to the prime contractor or higher tier subcontractor for any contract for the County, or any person associated therewith, as an inducement for the award of a subcontract or order.
- No public official shall have an interest in a contract awarded hereunder except in accordance with Tex. Loc. Govt. Code Chapter 171.

- **NOTICE:**

**ALL COMMUNICATIONS BY A VENDOR TO THE COUNTY, ITS OFFICIALS, AND DEPARTMENT HEADS REGARDING THIS PROCUREMENT SHALL BE DONE THROUGH THE HIDALGO COUNTY PURCHASING DEPARTMENT.**

No vendor, its representative, agent, or employee shall engage in private communication with a member of the Hidalgo County Commissioners Court or county department heads regarding any procurement of goods or services by the County from the date that the bid, RFP, or RFQ is released. No private communication regarding the purchase shall be permitted until the procurement process is complete and a purchase order is granted or a contract is entered into. Members of the commissioner's court are required to make a reasonable effort to inform themselves regarding potential procurements and have a duty to inquire of vendors, their representatives or employees, the nature of any private communication being sought prior to engaging in any communication. "Private Communication" means communication with any vendor outside of a posted meeting of the governing body, a regular meeting of a standing or appointed committee, or negotiation with a vendor which has been specifically authorized by the governing body.

**20. DISCLOSURE OF CONFLICT OF INTEREST**

Effective January 1, 2016, Chapter 176 of the Texas Local Government Code requires that any vendor, person, consultant or contractor considering doing business with Hidalgo County ("the County") to disclose in the Conflict of Interest Questionnaire (the "CIQ") attached as Exhibit D, the vendor, person, consultant or contractor's affiliation or business relationship that might cause a conflict of interest with the County. By law, the CIQ must be filed with the Hidalgo County Clerk's Office no later than the seventh business day after the date the person becomes aware of facts that require the statement to be filed. The disclosure requirement applies to a person or business that contracts or seeks to contract with Hidalgo County for the sale or purchase of property, goods or service. Any purchase order or contract resulting from this process shall be considered null and void if the successful respondent fails to comply with the Texas Local Government Code Chapter 176. Vendors, consultants, contractors and others who desire to conduct business with Hidalgo County are encouraged to refer to Texas Local Government Code Chapter 176 for details of this law. An offense under Texas Local Government Code Chapter 176 is a Class C Misdemeanor.

If applicable, completed Form CIQ must be submitted to the Hidalgo County Clerk's Office located at 100 N. Clossner, Edinburg, Texas 78539 - Hidalgo County Courthouse.

**COMPLETION AND SUBMISSION OF FORM CIQ IS THE SOLE RESPONSIBILITY OF THE PROSPECTIVE RESPONDENT. QUESTIONS REGARDING COMPLIANCE SHOULD BE DIRECTED TO YOUR LEGAL COUNSEL.**

**21. CERTIFICATE OF INTERESTED PARTIES (FORM HB1295)**

As of January 1, 2016, to comply with Texas Government Code Section §2252.908, and the rules issued by the Texas Ethics Commission found in Title 1, Section 46.1, 46.3 and 46.5 of the Texas Administrative Code, we have updated and revised our RFB packet. In accordance with these requirements, a business must submit a completed Certificate of Interested Parties Form 1295 to the County before the County may enter into a contract with the business entity. In box 3 of Form 1295, you will provide the RFB No. 2019-100, as shown on the packet. Once completed and filed with the Texas Ethics Commission, Form 1295 must be printed, signed, and submitted to our office either by facsimile transmission to (956) 292-7612 or via email to [tanya.delira@co.hidalgo.tx.us](mailto:tanya.delira@co.hidalgo.tx.us). Hidalgo County cannot enter into a contract until Form 1295 is submitted. Therefore, failure to timely submit signed Form 1295 may result in a delay of the award. Full instructions for completion and submittal of Form 1295 may be found on the Texas Ethics Commission website:

<https://www.ethics.state.tx.us/tec/1295-Info.htm>

THE AWARDED VENDOR WILL HAVE THIRTY (30) DAYS FROM THE DATE THE HIDALGO COUNTY COMMISSIONER'S COURT APPROVES THIS AGREEMENT TO SUBMIT THE SIGNED NOTARIZED FORM 1295. *HIDALGO COUNTY CANNOT ENTER INTO A CONTRACT UNTIL FORM 1295 IS SUBMITTED.*

22. If during the life of any contract awarded, the successful respondents' net prices generally available to other customers for items awarded herein are reduced below the contracted price, it is understood and agreed that the benefits of such reduction shall be extended to County.
23. Bids and all goods and services provided thereunder shall comply with all federal, state and local laws concerning this type(s) of goods and/or services.

24. Minimum Standards for Responsible Prospective Respondents: A prospective respondent must affirmatively demonstrate the respondent's responsibility. A prospective respondent, by submitting a qualification, represents to County that it meets the following requirements:
- Possess or is able to obtain adequate financial resources as required to perform under the qualification;
  - Be able to comply with the required or proposed delivery schedule;
  - Have a satisfactory record of performance;
  - Have a satisfactory record of integrity and ethics;
  - Be otherwise qualified and eligible to receive an award.
25. Successful respondent will pay or cause to be paid, without cost or expenses to County, all FICA, FUTA/SUTA and Federal Income Withholding Taxes of all employees, and all wages and benefits as required by Federal or State law. Successful respondents' officers, agents, and/or employees will not be entitled to any benefits of an employee or elected official of County, including, but not limited to, benefits associated with County civil service system.
26. Any contract award to a successful respondent will be in effect until (a) the contract expires, (b) delivery and acceptance of products, and/or performance of services ordered, or (c) terminated by County with thirty (30) day's written notice prior to cancellation.
27. County reserves the right to enforce performance of any contract awarded hereunder in any manner prescribed by law or deemed to be in the best interest of the County. County reserves the right to terminate the contract immediately in the event of breach or default by a successful respondent, or in the event, a successful respondent fails to:
- A. Meet schedules;
  - B. Pay any required fees or taxes; or
  - C. Perform in accordance with the requirements.
28. Successful respondent shall defend, indemnify and save harmless County and all its elected officials, officers, agents and employees from all suits, actions, or other claims of any character, name and description brought for or on account of any injuries or damages received or sustained by any person, persons, or property on account of any negligent act or fault of the successful respondent, or of any agent, employee, subcontractor or supplier in the execution of, or performance under, any contract which may result from qualification award. Successful respondent indemnifies and will indemnify and save harmless County from liability, claim or demand on their part, agents, servants, customers, and/or employees whether such liability, claim or demand to arise from event or casualty happening on or within the occupied premises themselves or happening upon or in any of the halls, elevators, entrances, stairways or approaches to the facilities within which the occupied premises are located. Successful respondent shall pay any judgment with costs which may be obtained against county growing out of such injury or damages, and shall, upon request, provide a defense to County by counsel reasonably acceptable to County. Successful respondents' indemnity hereunder shall include but is not limited to, claims relating to patent, copyright or trademark infringement, and the like, arising out of the goods or services provided by the successful respondent.
29. Successful respondent shall warrant that all items/services shall conform to the specifications and/or all warranties provided under the Uniform Commercial Code and be free from all defects in material, workmanship

and the like. Items supplied under a contract pursuant to this Request for Bids shall be subject to County approval. Items found to be defective or not meeting specifications shall be replaced by the successful respondent within two business days at no expense to County. Items that are not picked up within one (1) week after notification shall be deemed a donation to County and may be used or disposed of at County's discretion and without waiver of any other rights of County as to the items' nonconformity.

30. This document and any disputes arising hereunder shall be governed and construed according to the laws of the State of Texas and will be performable exclusively in Hidalgo County, Texas.

31. The successful respondent shall not assign, sell, transfer or convey its rights under any awarded contract, in whole or in part, without the prior written consent of County.

32. CONTRACTS SUBJECT TO FEDERAL AWARD:

- The procurement standards of 2 CFR, Part 200, including, but not limited to 2 CFR 200.317-200.326, and applicable Hidalgo County Purchasing Policy (found at <https://www.hidalgocounty.us/805/County-Administrative-Policies>) address the County's requirements, as a non-Federal entity, in regards to contracts it enters into that are subject to federal award. Pursuant to 2 CFR 200.236, the County, as a non-Federal entity, is required to include into contracts subject to federal award, the applicable provisions and contract clauses described in Appendix II to 2 CFR 200, the provisions of Appendix II to 2 CFR 200 and the required contract clauses found in **Exhibit "H"** are incorporated by reference, whether specified explicitly or not, as part of this procurement packet and any resulting agreement.
- In addition, should the County's contracts under Federal award be subject to assistance from the Federal Emergency Management Agency (FEMA), FEMA requires the inclusion of contract terms in addition to those under Appendix II to 2 CFR 200. **If applicable**, the additional contract clauses required by FEMA are found in **Exhibit "H"** and incorporated by reference, whether specified explicitly or not, as part of this procurement packet and any resulting agreement. Should the contract be subject to assistance from FEMA, it is the County's intention to comply with FEMA requirements; therefore, any conflict in terms should be resolved as such.
- **If applicable**, in accordance with 2 CFR 200.319, Contractors that develop or draft specifications, requirements, statements of work, or invitations for bids or requests for proposals must be excluded from competing for such procurements. (See 2 CFR 200.219). Additionally, Hidalgo County policy provides that for federal road projects, engineers, engineering firms, and/or a subsidiary, affiliate, or a consultant of the engineer or engineering firm who has received compensation from the County, that assist in the development of, or draft specifications, requirements, statements of work, or invitations for bids or requests for proposals, will be excluded from competing for such procurements (i.e...subsequent construction engineering/management and/or inspection/testing) for all other phases of the project. (See Hidalgo County Policy: "*Procedures for Selection and Contracting of Professional Service Providers for Federal Road Projects*" found at <https://www.hidalgocounty.us/805/County-Administrative-Policies>, which, if applicable, is incorporated by reference, whether specified explicitly or not, as part of this procurement packet and any resulting agreement for all purposes).

33. HISTORICALLY UNDERUTILIZED BUSINESS/DISADVANTAGED BUSINESS ENTERPRISES:

The County is committed to ensuring that Historically Underutilized Businesses (HUB) and Disadvantaged Business Enterprises (DBE) such as small business enterprises (SBE), minority and women-owned business enterprises (MWBE) receive a fair and equal opportunity for participation in the County's procurement process.

The County encourages the use of these enterprises both as prime and subcontractors. (See Exhibit "E" for requirements).

When federal funds are expended by the County, the County will take affirmative steps set forth in 2 CFR 200.321 to assure that small, minority, women-owned businesses and labor surplus area owned firms are used when possible. Pursuant to 2 CFR 321, the County requires that a prime contractor who uses sub-contractors take affirmative steps set forth in 2 CFR 200.321, including:

- a) Placing qualified small and minority business and women's business enterprises on solicitation lists;
- b) Assuring that small and minority businesses, and women's business enterprises are solicited whenever they are potential sources;
- c) Dividing total requirements, when economically feasible, into smaller tasks or quantities to permit maximum participation by small and minority business, and women's business enterprises;
- d) Establishing delivery schedules, where the requirement permits, which encourage participation by small and minority businesses, and women's business enterprises; and
- e) Using the services and assistance, as appropriate, of such organizations as the Small Business Administration and the Minority Business Development Agency of the Department of Commerce.

Nothing in this section is to be construed to require the County to award a contract other than as required by law and Hidalgo County policies and procedures.

34. Respondents shall provide with the qualification response, a list of at least three (3) references where like services have been supplied by their firm. Include the name of the business or government, address, telephone number and the name of the representative or contact person.
35. Respondents must provide all documentation requested with this Qualification in their response (except for CIQ Form if NOT APPLICABLE). Failure to provide this information may result in rejection of the qualification as nonconforming.

Request for Bids  
For  
**HIDALGO COUNTY**  
(All funding sources, programs & entities)

**“Pipes & Related Miscellaneous Items”**

**RFB No.: 2019-100-05-15-TDL**

To: Martha L. Salazar, CPPB, Purchasing Agent  
Hidalgo County Purchasing Department  
Physical Location: 2802 S. Business Hwy. 281  
Postal/ Mailing: 2812 S. Business Hwy. 281  
Edinburg, Texas 78539

In accordance with the Requirements, and subject to all laws and regulations of the United States and state and local laws, the undersigned respondent proposes and commits to furnish all labor, equipment, material, software, and services as set forth in the documents hereinbefore mentioned. The undersigned further agrees, upon acceptance of its qualification, to execute a contract and/or Purchase Order issued by Hidalgo County for performing and completing the work described in the Requirements within the time stated and for the prices proposed in the documents attached hereto and made a part hereof.

Respondent acknowledges receipt of all of the pages of the documents referenced in the Request for Bid Checklist presented in connection with this procurement. Respondent understands that Hidalgo County reserves the right to reject any or all bids and further reserves the right to design the evaluation criteria to be used in selecting the lowest and best qualification.

Respondent agrees that this qualification shall be good and may not be withdrawn for a period of ninety (90) calendar days after the scheduled closing time for receiving bids, as contained in the Requirements.

**Respectfully submitted,**

Firm: \_\_\_\_\_

Address: \_\_\_\_\_

By: \_\_\_\_\_

Printed Name: \_\_\_\_\_

Title: \_\_\_\_\_

EXHIBIT "A"  
SPECIFICATIONS  
HIDALGO COUNTY (All funding sources, programs & entities)  
"PIPES & Related Miscellaneous Items"  
RFB No.: 2019-100-05-15-TDL

---

**SPECIFICATIONS AND/OR REQUIREMENTS:**

Bidder(s) shall supply, where needed (on an "as needed" basis) in Hidalgo County or job site, "PIPES, Inlets, Manholes & Miscellaneous Items".

Bid information will be furnished to all Hidalgo County departments requiring pipes and delivery will involve numerous locations within Hidalgo County.

- I. LOCATIONS – Departments requiring pipes.
- II. DELIVERY INSTRUCTIONS  
Delivery hours will be arranged with each department requiring pipes. **Bidder(s) shall deliver** the amount of product requested to **location or job site** required within 24 hours, or earlier, if requested. Bidder(s) agree(s) that, to the extent an item is unavailable from bidder's own inventory; bidder(s) will be responsible for locating an alternative supplier and for providing the product to Hidalgo County for the bid price. **VENDOR(S) MUST UNLOAD ANY/ALL ITEMS LISTED AT THE REQUESTED SITE(S).**
- III. BID AWARD
  1. Hidalgo County may award the bid on a lump sum basis to one (1) bidder or to multiple bidders on an item by item basis in each category, whichever is in the best interest of the County. For evaluation and consideration of items bid, samples will be submitted upon request. Categories will be as follows:
    - Category A: Pipes
    - Category B: Inlets
    - Category C: Manholes
    - Category D: Miscellaneous

**CATEGORY (A) – PIPES**  
**CORRUGATED PVC STORM SEWER PIPE SPECIFICATION**

**1.0 SCOPE:**

Polyvinyl chloride (PVC) storm sewer/drain pipe and fitting shall be manufactured and tested in accordance with AASHTO Specifications M304.

**2.0 MATERIAL AND DESIGN**

The structural design of thermoplastic pipes shall be in accordance with AASHTO Standard Specifications for Highway Bridge; Section 8 titled "Soil-Thermoplastic Pipe Interaction Systems". To ensure long-term design strength properties, PVC Pipe shall be manufactured from 12454B or 12454C cell class material per ASTM D1784.

**3.0 JOINING SYSTEM:**

Joints may be either plastic sleeve with gaskets or an integral bell-gasket joint. When the joint is assembled, it shall prevent misalignment of adjacent pipes and form either a soil (2 psi hydrostatic test per AASHTO Standard Specifications for Highway Bridges: Section 26.4.2.4) or watertight joint (10.8 psi test per ASTM D3212 "Standard Specifications for Joints for Drain and Sewer Plastic Pipes Using Flexible Elastomeric Seals" as required.

**4.0 INSTALLATION**

PVC thermoplastic pipe and fittings manufactured to these specifications shall be installed in accordance with ASTM D2321-89.

EXHIBIT "A"  
 SPECIFICATIONS  
 HIDALGO COUNTY (All funding sources, programs & entities)  
 "PIPES & Related Miscellaneous Items"  
 RFB No.: 2019-100-05-15-TDL

Heights of Cover

DIAMETER	CORRUGATED PVC PIPE (AASHTO M304)
INCHES	FEET
12	49
15	47
18	51
24	50
30	50

\*Minimum cover (H-20 live load) = (ASTM D2321 with Class A1 embedment)

**CORRUGATED STEEL STORM SEWER PIPE SPECIFICATIONS**

**1.0 GENERAL**

This item shall govern the furnishings of corrugated steel pipe and pipe-arch for culverts and storm sewer for the types, sizes and designations as specified in these specifications.

**2.0 MATERIALS**

This pipe shall be fabricated from sheets conforming to the current AASHTO M-274 (ASTM A819) specification for ALUMINIZED STEEL Type 2 material or the current AASHTO M-246 (ASTM 742) specification for POLYMER coated galvanized steel material.

**3.0 MANUFACTURE**

This pipe shall meet the requirements of AASHTO M-36 (ASTM A760) for corrugated steel pipe. All pipe shall be manufactured with a minimum of two-re-rolled annular ends.

**4.0 CLASSIFICATION (TYPE) FOR DIAMETERS 46" THROUGH 96"**

This pipe shall be manufactured to conform to the current AASHTO M-36 (ASTM A 760) specification and shall have an extended helical corrugation pattern of 3/4 x 3/4" 7 1/2" as described in AASHTO M-36 (ASTM A 760).

All round pipe shall be manufactured to conform to the current AASHTO M 245 (ASTM A 762 & A 760) specification and shall have a full circular cross section with a smooth steel liner and helically corrugated shell, integrally attached at helical lock seams. All round pipe shall conform to the Type IA pipe classification. All pipe arches shall conform to the Type IIA classification.

Type I pipe classifications will also be considered. These pipes shall be manufactured out of ALUMINIZED STEEL Type 2 or POLYMER coated galvanized steel as referenced above.

**5.0 POST APPLIED COATING**

All Pipes manufactured with ALUMINIZED STEEL Type 2 shall be fully coated both inside and out with a minimum thickness of 0.05 in. (1.3 mm) measured from the crest of the corrugations, on the top of ribs, (as in Type IR pipe) or on the smooth inside surface of the pipe. The coating shall be uniform Class B (bituminous) or Class M (mastic) material as described in AASHTO M-190 (ASTM A 849).

**6.0 GAUGE**

Unless otherwise specified on the specifications, gauges shall be minimum as follows:

<b>TYPE IR (SPIRAL CORRUGATION)</b>	
DIAMETER	GAUGE
36-48"	16
54-60"	14
66-96"	12
<b>TYPE I (STANDARD)</b>	
54-138"	12
144"	10
<b>All Types IA shall be 12 gauge shell and 18 gauge liner.</b>	

**EXHIBIT "A"**  
**SPECIFICATIONS**  
**HIDALGO COUNTY (All funding sources, programs & entities)**  
**"PIPES & Related Miscellaneous Items"**  
**RFB No.: 2019-100-05-15-TDL**

---

**7.0 COUPLING BANDS**

Coupling bands shall be of the same base material and coating as the pipe. Coupling bands shall lap evenly on each of the pipes being connected and shall fit securely into at least one full circumferential corrugation to form a tightly closed joint.

All pipes shall be field jointed with corrugated locking bands. Connecting bands shall be drawn together by means of not less than two bolts not less than ½ in. (13 mm) diameter through angles or bar and strap device suitable welded or riveted.

Coupling bands shall be no more than three normal sheet thickness lighter than the pipe to be connected and in no case thinner than 0.052 in. (1.32 mm).

**8.0 INSTALLATION**

Corrugated steel pipe shall be installed as outlined in AASHTO Standard Specifications for Highway Bridges, Section 26 and ASTM A798.

**9.0 MEASUREMENT**

Corrugated steel pipe will be measured by linear foot. Such measurements shall be made between the ends of the barrel along its central axis. Where spurs or branches, or connections to existing pipe lines are involved, measurements of the spur or new connecting pipe will be made from the intersection of the central axis with the outside surface of the pipe into which it connects. Where inlets, headwalls, catch basins, manholes, junction chambers or other structures are included in lines of pipe that length of pipe tying into the other structure wall will be included for measurement but no other portion of the structure length or width will be included.

For multiple pipes, the measured length will be the sum of the lengths of the barrels, measured as prescribed above.

In the event of a change in design which either increases or decreases the quantity of pipe, the variation in quantity will be measured as prescribed above and the quantity shown in the specifications will be increased or decreased as the case may be.

**10.0 PAYMENT**

Payment for corrugated steel pipe, measured as prescribed above will be made at the contract unit price bid per linear foot for various sizes, gauges and types of corrugated steel pipe.

Payments shall be full compensation for furnishings, transporting and installing the pipe. This includes materials, labor, equipment, tools and incidentals necessary to complete the installation in accordance to these specifications.

EXHIBIT "A"  
 SPECIFICATIONS  
 HIDALGO COUNTY (All funding sources, programs & entities)  
 "PIPES & Related Miscellaneous Items"  
 RFB No.: 2019-100-05-15-TDL

**CATEGORY (A) – PIPES**  
**REINFORCED CONCRETE PIPE - GASKET JOINT PIPE SPECIFICATIONS**

REINFORCED CONCRETE PIPE - GASKET JOINT PIPE SPECIFICATIONS						
CLASS III - ASTM C76 STANDARDS						
PIPE I.D.	WALL THICKNESS	CONCRETE STRENGTH	CAGE			PIPE WEIGHT
(in)	(in)	(PSI)	TYPE	INNER	OUTER	(LBS)
15	3.00	4,000	SINGLE	3"x6"-W1.75/W2.5		1,520
18	3.25					1,920
24	3.75					2,840
30	4.25			4,020		
36	4.75			3"x6"-W1.75/W2.5		5,520
42	5.25					7,100
48	5.75		8,280			
54	6.25		DOUBLE	3"x8"-W3.0/W2.0	3"x6"-W2.5/W2.5	9,800
60	6.75			3"x6"-W4.0/W2.5	3"x6"-W3.5/W2.5	12,184
72	7.75			2"x6"-W4.5/W2.5	3"x6"-W4.0/W2.5	15,900
				2"x6"-W6.0/W2.5	3"x8"-W5.75/W3.0	

REINFORCED CONCRETE PIPE - GASKET JOINT PIPE SPECIFICATIONS						
CLASS IV - ASTM C76 STANDARDS						
PIPE I.D.	WALL THICKNESS	CONCRETE STRENGTH	CAGE			PIPE WEIGHT
(in)	(in)	(PSI)	TYPE	INNER	OUTER	(LBS)
15	3.00	4,000	SINGLE	3"x6"-W2.5/W2.5		1,520
18	3.25					1,920
24	3.75					2,840
30	4.25		DOUBLE	3"x6"-W3.5/W2.5		4,020
36	4.75			3"x6"-W4.0/W2.5	3"x6"-W2.0/W2.0	5,520
42	5.25			3"x6"-W3.5/W2.5	3"x6"-W2.0/W2.0	7,100
48	5.75			3"x8"-W5.0/W2.5	3"x6"-W3.0/W2.5	8,280
54	6.25			3"x6"-W6.5/W3.0	3"x6"-W4.0/W2.5	9,800
60	6.75			2"x8"-W5.75/W3.0	3"x8"-W5.0/W2.5	12,184
72	7.75	5,000	2"x8"-W7.0/W3.0	3"x6"-W6.25/W3.0	15,900	
			2"x8"-W10.0/W4.0	2"x8"-W6.0/W2.5		

EXHIBIT "A"  
 SPECIFICATIONS  
 HIDALGO COUNTY (All funding sources, programs & entities)  
 "PIPES & Related Miscellaneous Items"  
 RFB No.: 2019-100-05-15-TDL

REINFORCED CONCRETE PIPE - GASKET JOINT PIPE SPECIFICATIONS							
CLASS V - ASTM C76 STANDARDS							
PIPE I.D.	WALL THICKNESS	CONCRETE STRENGTH	CAGE			PIPE WEIGHT	
(in)	(in)	(PSI)	TYPE	INNER	OUTER	(LBS)	
15	3.00	6,000	SINGLE	3"x6"-W2.5/W2.5		1,520	
18	3.25					1,920	
24	3.75		DOUBLE		3"x6"-W3.0/W2.5	3"x6"-W2.5/W2.5	2,840
30	4.25				3"x6"-W4.5/W2.5	3"x6"-W3.0/W2.5	4,020
36	4.75				2"x6"-W4.5/W2.5	3"x6"-W4.0/W2.5	5,520
42	5.25				2"x8"-W6.0/W2.5	3"x8"-W5.75/W3.0	7,100
48	5.75				2"x8"-W8.0/W3.5	3"x8"-W7.0/W3.0	8,280
54	6.25				2"x8"-W10.0/W4.0	2"x8"-W6.0/W2.5	9,800
60	6.75				2"x8"-W11.5/W4.5	2"x8"-W7.0/W3.0	12,184
72	7.75				2"x6"-W8.5/W6.5	2"x8"-W10.0/W4.0	15,900

**General Note:**

1. Concrete gasket pipe shall meet Bureau of Reclamation R-4 Joint O-Ring gasket ASTM C361 Standards and price quote shall be included with the pipes.
2. All welded Wire Fabric Steel shall meet ASTM 82 and ASTM 185 Standards.
3. Aggregates shall meet ASTM C 33 Standards.
4. Fly Ash shall meet ASTM C 618-97 Standards.
5. Type II Cement shall meet ASTM C 150 Standards.
6. The maximum lengths of pipe sections shall be 8 feet.

The following are the technical requirements for the Reinforced Gasket Joint Concrete Pipe ASTM C-76 Class III.

**D.1 GENERAL:**

Pipe shall be manufactured and tested according to ASTM Designation: C-361 except as hereinafter changed and further specified. The requirements for cement, admixture, concrete strength, wall thickness, joints, manufacture and handling of pipe shall be in accordance with Paragraphs C-2, C-3, C-4, C-5, C-6, C-7, C-8, C-10, C-11, C-12, C-13 and C-14, respectively.

**D.2 STEEL REINFORCEMENTS:**

The reinforcing steel shall conform to requirements of Class III reinforced pipe, ASTM Designation: C-76. Reinforcements may be circular or elliptical.

**D-3 PHYSICAL TEST REQUIREMENTS:**

The test for internal hydrostatic pressure on the pipe shall not be less than that shown in Table "A" Paragraph C-10 thereof. The test for minimum 3-edge bearing load (pounds per linear foot) shall not be less than that required for Class III reinforced concrete pipe, ASTM Designation C-76.

**RELATED PARAGRAPHS C-2 CEMENT:**

The cement shall be Type II, low alkali in accordance with Federal Specifications SS-C 1960/3. The Contractor shall furnish certificates from the mill manufacturing the cement evidencing compliance with these specifications.

**C-3 ADMIXTURE:**

All concrete in concrete pipe placed by the placing and vibrated method shall have air-entraining agent conforming to ASTM Designations: C260. The amount of air-entraining agent used shall be such as will effect the entrainment of  $2-1/2 \pm 1$  percent of air by volume, of the concrete as discharged from the mixer. Natural cement, slag cement, pozzolon or other mixtures shall not be added to the concrete without the written authorization of the Engineer in charge of the project.

EXHIBIT "A"  
SPECIFICATIONS  
HIDALGO COUNTY (All funding sources, programs & entities)  
"PIPES & Related Miscellaneous Items"  
RFB No.: 2019-100-05-15-TDL

---

**C-4 CONCRETE STRENGTH:**

The strength requirements shall be 4,000 pounds per square inch in 28 days. The 4,000 PSI concrete test shall be in accordance with the latest edition of ASTM Designation: C-76.

**C-5 CONCRETE MIXTURE:**

The aggregate requirements of the latest ASTM Designation: C361 are changed to include, "the maximum size coarse aggregate shall be of the largest size practicable for placement considering the wall thickness of the pipe but shall not exceed 1-1/2 inches. The percentage of coarse aggregate to the total aggregate shall be as high as practicable for manufacture of the pipe".

**C-6 CURING REQUIREMENTS:**

The curing requirements in the latest edition of ASTM Designation: C361 are changed to include this additional requirement at the end of the paragraph: "If forms are stripped immediately after the pipe is cast and moved to the curing area, the concrete pipe shall not be lifted or tipped until a minimum concrete compressive strength of 2,500 PSI is attained. Determination of the required strength shall be accomplished by tests of concrete cylinders as described in the latest edition of ASTM Designation: C361".

**C-7 WALL THICKNESS:**

The thickness of the pipe wall shall be not less than that shown in Table A, Paragraph C-10, Physical Test Requirements", hereof.

**C-8 PIPE LENGTHS:**

The maximum lengths of pipe sections shall be 8 feet.

**C-10 PHYSICAL TEST REQUIREMENTS:**

The hydrostatic test pressures for the pipe and rubber gasket joint required in the latest edition of ASTM Designations 361 are changed to those specified in Table A. The Contractor shall also perform external load crushing strength test on the pipe. The external load crushing strength test shall be in accordance with the minimum three-edge bearing load as specified in Table A.

EXHIBIT "A"  
 SPECIFICATIONS  
 HIDALGO COUNTY (All funding sources, programs & entities)  
 "PIPES & Related Miscellaneous Items"  
 RFB No.: 2019-100-05-15-TDL

**TABLE A: PHYSICAL TEST REQUIREMENTS**

Internal diameter (inches)	Minimum Shell Thickness (inches)	Internal Hydrostatic Pressure On Individual Section of Pipe (PSI)	Minimum 3-Edge Bearing Load (pounds per linear foot)
15	2	50	1,700
16	2	50	1,800
18	2	50	1,900
21	2 - 1/4	45	2,100
24	2 - 1/2	40	2,200
30	2 - 3/4	35	2,500
36	3	30	4,050
42	4 - 1/2	30	4,725
48	5	30	5,400
54	4 - 1/2	25	6,075
60	6	25	6,750
72	7	25	8,100

**C-11 JOINTS:**

Joints shall be made with round rubber gasket in conformance with the latest edition of ASTM Designation: C-361 and price quote shall be included with the pipes.

**REINFORCED CONCRETE PIPE - TONGUE & GROOVE PIPE SPECIFICATIONS**

REINFORCED CONCRETE PIPE - TONGUE & GROOVE PIPE SPECIFICATIONS						
CLASS III - ASTM C76 STANDARDS						
PIPE I.D.	WALL THICKNESS	CONCRETE STRENGTH	CAGE			PIPE WEIGHT
(in)	(in)	(PSI)	TYPE	INNER	OUTER	(LBS)
15	2.25	4,000	SINGLE	3"x6"-W1.75/W2.5		1,045
18	2.50					1,400
24	3.00					2,100
30	3.50					3,050
36	4.00					4,200
42	5.25		DOUBLE	3"x8"-W3.0/W2.0	3"x6"-W1.75/W2.5	6,250
48	5.75					8,100
54	6.25					9,420
60	6.75					11,500
72	7.75					15,900

EXHIBIT "A"  
 SPECIFICATIONS  
 HIDALGO COUNTY (All funding sources, programs & entities)  
 "PIPES & Related Miscellaneous Items"  
 RFB No.: 2019-100-05-15-TDL

REINFORCED CONCRETE PIPE - TONGUE & GROOVE PIPE SPECIFICATIONS						
CLASS IV - ASTM C76 STANDARDS						
PIPE I.D.	WALL THICKNESS	CONCRETE STRENGTH	CAGE			PIPE WEIGHT
(in)	(in)	(PSI)	TYPE	INNER	OUTER	(LBS)
15	3.00	4,000	SINGLE	3"x6"-W2.5/W2.5		1,045
18	3.25			2"x6"-W2.5/W2.5		1,400
24	3.75			2"x6"-W4.5/W2.5		2,100
30	4.25			2"x8"-W6.0/W2.5		3,050
36	4.75		DOUBLE	2"x8"-W5.0/W3.0	3"x8"-W4.5/W2.5	4,200
42	5.25			3"x6"-W5.0/W2.5	3"x6"-W3.0/W2.5	6,250
48	5.75			3"x6"-W6.5/W3.0	3"x6"-W4.0/W2.5	8,100
54	6.25			2"x8"-W5.75/W3.0	3"x6"-W5.0/W2.5	9,420
60	6.75			2"x8"-W7.0/W3.0	3"x8"-W6.25/W3.0	11,500
72	7.75			2"x8"-W10.0/W4.0	2"x8"-W6.0/W2.5	15,900
		5,000				

REINFORCED CONCRETE PIPE - TONGUE & GROOVE PIPE SPECIFICATIONS						
CLASS V - ASTM C76 STANDARDS						
PIPE I.D.	WALL THICKNESS	CONCRETE STRENGTH	CAGE			PIPE WEIGHT
(in)	(in)	(PSI)	TYPE	INNER	OUTER	(LBS)
15	3.00	6,000	SINGLE	3"x6"-W3.5/W2.5		1,045
18	3.25			3"x8"-W4.75/W2.5		1,400
24	3.75			3"x8"-W6.0/W2.5		2,100
30	4.25		DOUBLE	2"x8"-W7.0/W3.0	3"x8"-W6.25/W3.0	3,050
36	4.75			2"x8"-W8.25/W3.5	2"x8"-W5.0/W3.0	4,200
42	5.25			2"x8"-W6.0/W2.5	3"x8"-W5.75/W3.0	6,250
48	5.75			2"x8"-W8.0/W3.5	3"x8"-W7.0/W3.0	8,100
54	6.25			2"x8"-W10.0/W4.0	2"x8"-W6.0/W2.5	9,420
60	6.75			2"x8"-W11.5/W4.5	2"x8"-W7.0/W3.0	11,500
72	7.75			2"x6"-W8.5/W6.5	2"x8"-W10.0/W4.0	15,900

**General Note:**

1. All welded wire fabric steel shall meet ASTM 82 and ASTM 185 standards.
2. Aggregates shall meet ASTM C 33 standards.
3. Fly ash shall meet ASTM C 618-97 standards.
4. Type II cement shall meet ASTM C 150 standards.
5. Concrete joint sealant shall meet ASTM C 990 standards.
6. Concrete joint primer shall meet ASTM D 41 standards.
7. The maximum lengths of pipe sections shall be 8 feet.

## REINFORCED POLYETHYLENE PIPE SPECIFICATIONS

### SCOPE

This specification(s) describes reinforced polyethylene pipe for use in gravity flow storm drain and culvert applications in 24" through 96" nominal diameters.

### DESCRIPTION

This pipe shall have a smooth waterway and exterior profile that is reinforced with high strength galvanized steel ribs. The continuous reinforcing ribs are completely encased within the polyethylene profile. Reinforced polyethylene pipe is manufactured using a helical winding process that results in continuously fusion welded circumferential lap seam. The pipe profile is manufactured using high pressure-rated thermoplastic meeting the requirements of ASTM F2562 "Standard Specification for Steel Reinforced Thermoplastic Ribbed Pipe and Fittings for Non-Pressure Drainage and Sewerage". For the purposes of hydraulic design, the recommended Manning's "n" value shall be 0.013 for pipe diameters included within this specification.

### MATERIAL PROPERTIES

Virgin high density polyethylene pressure-related resins are used to manufacture reinforced polyethylene pipe and complimentary fabricated fittings. Resins shall conform to be minimum requirements of cell classification 345464 C as defined and described in the latest version of ASTM D3350 "Standard Specification for Polyethylene Plastic Pipe and Fittings Materials".

### JOINT PERFORMANCE

Pipe lengths shall be joined on site using bell & spigots especially designed for reinforced polyethylene pipe. Both bell and spigot shall be reinforced with steel that is fully encased in pressure rated high density polyethylene meeting the requirements set forth in the above Material Properties paragraph and shall be watertight to an internal water pressure of 15 PSI when tested in accordance with ASTM D3212 "Standard Specification for Joints for Drain and Sewer Plastic Pipes Using Flexible Elastometric Seals".

### FITTINGS

All fittings shall be fabricated from reinforced polyethylene pipe using fusion welded construction to ensure no loss of structural integrity of water-tightness at welded seams and joints.

### INSTALLATION

Installation shall be in accordance with ASTM D2321 "Practice for Underground Installation of Thermoplastic Pipe for Sewers and Other Gravity-Flow Applications" along with product-specific recommendation by the manufacturer. Minimum cover shall be 1 ft. and maximum cover shall be 30 ft.

## AWWA C900 PVC PLASTIC PRESSURE PIPE SPECIFICATIONS

### SCOPE

This specification designates general requirements for 4" through 12" C.I.O.D.'s pipe produced in blue or white un-plasticized polyvinyl chloride (PVC) plastic pressure pipe with integral bell and spigot joints for the conveyance of water and other fluids. This pipe shall meet the requirements of AWWA Standard C900 "Polyvinyl Chloride (PVC) Water Distribution Pipe".

### MATERIALS

All pipes shall be made from quality PVC resin, compounded to provide physical and mechanical properties that equal or exceed cell class 12454 as defined in ASTM D1784.

### HYDROSTATIC PROOF TESTING

Each standard length of pipe is tested up to 400 psi for Pressure Class 165; 600 psi for Pressure Class 235; 800 psi for Pressure Class 305 for a minimum of 5 seconds. The integral bell shall be tested with the pipe.

### STANDARD LAYING LENGTHS

Standard laying lengths are 20 feet for all sizes.

**EXHIBIT "A"**  
**SPECIFICATIONS**  
**HIDALGO COUNTY (All funding sources, programs & entities)**  
**"PIPES & Related Miscellaneous Items"**  
**RFB No.: 2019-100-05-15-TDL**

**PIPE**

All pipes shall be suitable for use as pressure conduit. Provisions must be made for expansion and contraction at each joint with an elastomeric gasket. The bell shall consist of an integral wall section with a factory installed, solid cross section Rieber or other elastomeric gasket, which meets the requirements of ASTM F477. The bell section shall be designed to be at least as hydrostatically strong as the pipe barrel and meet the requirements of AWWA C900. The joint design shall meet the requirements of ASTM D3139 under both pressure and 22 in. Hg vacuum. Sized and dimensions shall be as shown in this specification.

**QUICK BURST TEST**

Randomly selected samples testing in accordance with AWWA C900 and UL 1285 shall withstand, without failure, the pressures listed below when applied for 60-70 seconds.

DR	PRESSURE CLASS (psi)		MINIMUM BURST PRESSURE AT 73 F (psi)
	AWWA C900-97/FM 1612	AWWA C900-07	
25	100	165	535
18	150	235	755
14	200	305	985

**DROP IMPACT TEST**

Pipe shall withstand, without failure using Tup "B" and Flat Rate Holder "B", at 73 F, a tup impact energy of 100 ft-lbf for all Pressure Class of 4"-12" trade sizes. There shall be no visible evidence of shattering or splitting when the energy is imposed.

**AWWA C905 PVC PLASTIC WATER PIPE SPECIFICATIONS**

**SCOPE**

This specification designates general requirements for 14" through 48" un-plasticized polyvinyl chloride (PVC) plastic water pipe with integral bell and spigot joints for the conveyance of water and other fluids. This pipe shall meet AWWA C905 ANSI/NSF-61 and ANSI/UL 1285 (14" – 24").

**MATERIALS**

Pipe shall meet the requirements of AWWA Standard C905 "Polyvinyl Chloride (PVC) Water Transmission Pipe." All pipes shall be made from quality PVC resin, compounded to provide physical and mechanical properties that equal or exceed cell class 12454 as defined in ASTM D1784.

**STANDARD LAYING LENGTHS**

Standard laying lengths are 20 feet for all sizes.

**PIPE**

All pipes shall be suitable for use as pressure conduit. Provisions must be made for expansion and contraction at each joint with an elastomeric gasket. The bell shall consist of an integral wall section with a factory installed, solid cross section Rieber/other elastomeric gasket, which meets the requirements of ASTM F477. The bell section shall be designed to be at least as hydrostatically strong as the pipe barrel and meet the requirement of AWWA C905. The joint designs shall meet requirements of ASTM D3139, under both pressure and 22 in. Hg vacuum. Sizes and dimensions shall be as shown in this specification.

**QUICK BURST TEST**

Randomly selected samples tested in accordance with ANSI/UL 1285 shall withstand, without failure, the pressures listed below when applied for 60-70 seconds.

DR	PRESSURE RATING (psi)	MINIMUM BURST
18	235	755
25	165	535
32.5	125	400
41	100	315
51	80	255

EXHIBIT "A"  
 SPECIFICATIONS  
 HIDALGO COUNTY (All funding sources, programs & entities)  
 "PIPES & Related Miscellaneous Items"  
 RFB No.: 2019-100-05-15-TDL

**FLATTENING TEST**

Specimens of pipe, a minimum of 6 in. (150 mm) long, shall be flattened between parallel plates in a suitable press until the distance between the plates is 40 percent of OD of the pipe. The rate of flattening shall be uniform and such that the compression is completed within 2 to 5 minutes. There shall be no evidence of splitting, cracking or breaking.

**SDR 26 AND SDR 35 GASKETED GRAVITY SANITARY SEWER PIPE**

PVC gravity sewer pipe shall be made from a compound conforming to a cell classification of 12454 or 12364 as defined by ASTM D1784 and in accordance with ASTM D3034 for sizes four inch through fifteen inch. The wall thickness, when tested according to ASTM D3412, shall correspond to a dimension ratio of SDR 35 with a pipe stiffness value of 46 or SDR 26 with a pipe stiffness of 115 for heavy wall pipe. Integral bells shall incorporate locked in gaskets meeting the requirements of ASTM D3212 and F477. The pipe shall be provided in lengths of 14 feet or 20 feet as required.

**ASTM D3034 GASKETED GRAVITY SEWER PIPE**

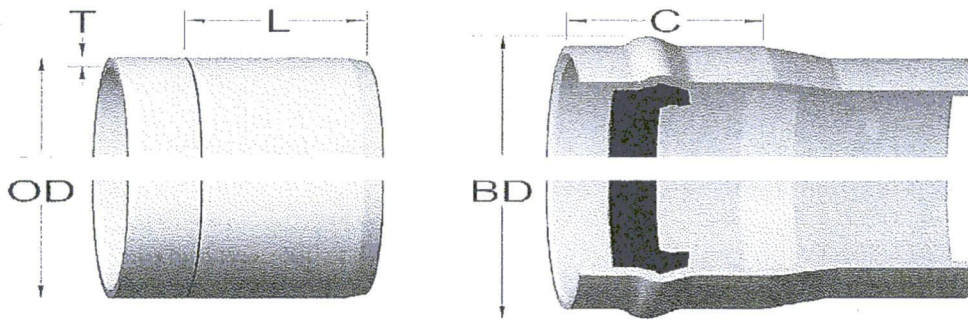

NOMINAL PIPE SIZE	OUTSIDE DIA. - NOM. (OD)	*APPROX. BELL DIA. (BD)	**APPROX. BELL DEPTH (C)	INSERT MARK (L)
4"	4.215	5.25	3.75	3.13
6"	6.275	7.50	4.63	4.00
8"	8.400	10.00	5.25	4.13
10"	10.500	12.25	5.88	5.13
12"	12.500	14.25	6.50	5.38
15"	15.300	17.25	7.75	7.38

NOMINAL PIPE SIZE	SDR 35 (T)	SDR 26 (T)
4"	.120	.162
6"	.180	.241
8"	.240	.323
10"	.300	.404
12"	.360	.481
15"	.437	.588

**HIGH PERFORMANCE (HP) POLYPROPYLENE STORM PIPE**

**1.0 SCOPE:**

This specification includes materials and test methods for 12 to 60 inch diameter HP Polypropylene Pipe. The requirements of this specification are intended to provide pipe and fittings suitable for underground use in gravity-flow applications such as storm sewers, drainage and under-drains.

**2.0 PIPE:**

12 to 30 inch HP Polypropylene Pipe shall have a smooth interior and annular exterior corrugation and are required to meet or exceed ASTM F2736 and AASHTO M330. 36 to 60 inch pipe shall have a smooth interior and annular exterior corrugations and are required to meet or exceed ASTM F2881 and AASHTO M330. Pipe and fittings shall be homogeneous throughout and free from visible cracks, holes, foreign inclusions or other injurious defects.

EXHIBIT "A"  
 SPECIFICATIONS  
 HIDALGO COUNTY (All funding sources, programs & entities)  
 "PIPES & Related Miscellaneous Items"  
 RFB No.: 2019-100-05-15-TDL

**3.0 FITTINGS:**

Fittings shall conform to ASTM F2736, ASTM F2881 and AASHTO M330, for the respective diameters. Bell & spigot connections shall utilize a spun-on, welded or integral bell and spigot with gaskets meeting ASTM F477. Bell & spigot fittings joint shall meet the watertight joint performance requirements of ASTM D3212. Corrugated couplings shall be split collar, engaging at least 2 full corrugations.

**4.0 JOINTS:**

HP Polypropylene Pipe shall be joined with a gasketed integral bell & spigot joint meeting the requirements of ASTM F2736 or F2881, for the respective diameters.

HP Polypropylene Pipe shall be watertight according to the requirements of ASTM D3212. Spigots shall have gaskets meeting the requirements of ASTM F477. Gasket shall be installed by the pipe manufacturer and covered with a removable, protective wrap to ensure the gasket is free from debris. A joint lubricant available from the manufacturer shall be used on the gasket and bell during assembly.

HP Polypropylene Pipe shall have a reinforced bell with a polymer composite band installed by the manufacturer.

**5.0 MATERIAL PROPERTIES:**

Polypropylene compound for pipe and fitting production shall be impact modified copolymer meeting the material requirements of ASTM F2736, Section 4, ASTM F2881, Section 5 and AASHTO M330, Section 6.1, for the respective diameters.

**6.0 INSTALLATION:**

Installation shall be in accordance with ASTM D2321, manufacturers recommended installation guidelines and plan specifications.

**7.0 PIPE DIMENSIONS:**

<b>Nominal Pipe I.D. in (mm)</b>	12 (300)	15 (375)	18 (450)	24 (600)	30 (750)	36 (900)	42 (1050)	48 (1200)	60 (1500)
<b>Average Pipe I.D. In (mm)</b>	12.1 (307)	14.9 (378)	18.0 (457)	24.1 (612)	30.1 (765)	35.7 (907)	41.8 (1062)	47.3 (1201)	59.3 (1506)
<b>Average Pipe O.D. in (mm)</b>	14.5 (368)	17.6 (447)	21.2 (538)	28.0 (711)	35.4 (899)	41.1 (1044)	47.2 (1199)	53.8 (1367)	66.5 (1689)
<b>Minimum Pipe Stiffness * @ 5% Deflection* #/in./in. (kN/m<sup>2</sup>)</b>	75 (520)	60 (411)	56 (385)	50 (343)	46 (320)	40 (275)	35 (240)	35 (240)	30 (205)

**HIGH DENSITY POLYETHYLENE PIPE (HDPE)**

**SCOPE:**

This specification describes 4- through 60 inch (100 to 1500 mm) HDPE pipe (per ASTM F2648) for use in gravity-flow land drainage applications.

**PIPE Requirements:**

HDPE pipe (per ASTM F2648) shall have smooth interior and annular exterior corrugations.

- 4-through 60 inch (100 to 1500 mm) shall meet ASTM F2648
- Manning's "n" value for use in design shall be 0.012

**Joint Performance:**

Pipe shall be joined using a bell & spigot joint meeting ASTM F2648. The joint shall be soil-tight and gaskets, when applicable, shall meet the requirements of ASTM F477. Gaskets shall be installed by the pipe manufacturer and covered with a removable wrap to ensure the gasket is free from debris. A joint lubricant supplied by the manufacturer shall be used on the gasket and bell during assembly.

EXHIBIT "A"  
 SPECIFICATIONS  
 HIDALGO COUNTY (All funding sources, programs & entities)  
 "PIPES & Related Miscellaneous Items"  
 RFB No.: 2019-100-05-15-TDL

**Fittings:**

Fittings shall conform to ASTM F 2306. Bell and spigot connections shall utilize a spun-on or welded bell and valley or saddle gasket meeting the soil-tight joint performance requirements of ASTM F 2306.

**Material Properties**

Material for pipe production shall be an engineered compound of virgin and recycled high density polyethylene conforming with the minimum requirements of cell classification 424420C (ESCR Test Condition B) for 4-through 10 inch (100 to 250 mm) diameters, and 435420C (ESCR Test Condition B) for 12 through 60 inch (300 to 1500 mm) diameters, as defined and described in the latest version of ASTM D3350, except that carbon black content should not exceed 4%. The design engineer shall verify compatibility with overall system including structural, hydraulic, material and installation requirements for a given application.

**Installation**

Installation shall be in accordance with ASTM D2321 and manufacturers published installation guidelines, with the exception that minimum cover in trafficked areas for 4-through 48 inch (100 to 1200 mm) diameters shall be one foot. (0.3 m) and for 60 inch (1500 mm) diameters, the minimum cover shall be 2 ft. (0.6 m) in single run applications. Backfill for minimum fill heights depend on embedment material and compaction level; please refer to manufactures guide lines.

<b>Pipe I.D. In mm</b>	4 (100)	6 (150)	8 (200)	10 (250)	12 (300)	15 (375)	18 (450)	24 (600)	30 (750)	36 (900)	42 (1050)	48 (1200)	60 (1500)
<b>Pipe O.D. * In mm</b>	4.8 (122)	6.9 (175)	9.1 (231)	11.4 (290)	14.5 (368)	18 (457)	22 (559)	28 (711)	36 (914)	42 (1067)	48 (1219)	54 (1372)	67 (1702)
<b>Perforations</b>	All diameters availability with or without perforation												

\*Pipe O.D. values are provided for reference purposes only. Values stated for 12 through 60 inch are +/- 1 inch.

**TERMS & CONDITIONS:**

1. The contract term will be for a period of one (1) year period with Hidalgo County's option to extend the contract for an additional one (1) year under the same rates, terms and conditions.
2. Hidalgo County reserves the right to continue this bid for an additional sixty (60) day grace period at the end of the contract term for unforeseen delay in award of new bid for next contract.
3. Hidalgo County reserves the right to hold the bids received for a period of ninety (90) days without taking action hereon.
4. Hidalgo County may award the bid on a lump sum basis to one (1) bidder or to multiple bidders on an item by item basis in each category, whichever is in the best interest of the County. For evaluation and consideration of items bid, samples will be submitted upon request. Categories will be as follows.
5. Hidalgo County reserves the right to reject any/all bids, to waive any/all formalities or Technicalities, or to accept the bid considered the best and most advantageous to the County.
6. After bid is awarded and low bidder(s) default(s) in meeting the general instructions to bidders and/or comply with contractual agreement, Hidalgo County reserves the right to seek services from the next low bidder(s). In such event, County shall charge the successful bidder(s) the difference for any additional cost of such item(s).
7. Any contract awarded to a successful bidder will be in effect until:
  - (a) The contract expires,
  - (b) Delivery and acceptance of products and/or performance of service ordered,
  - (c) Terminated by County with thirty (30) days written notice prior to cancellation.
8. It is understood and agreed that in case Hidalgo County should need "any items listed" and it is not available within the time frame needed from the successful Bidder during the term of this contract, Hidalgo County reserves the right to purchase these items from other sources other than the successful Bidder and shall not be in violation of any terms or conditions of said contract.

EXHIBIT "A"  
SPECIFICATIONS  
HIDALGO COUNTY (All funding sources, programs & entities)  
"PIPES & Related Miscellaneous Items"  
RFB No.: 2019-100-05-15-TDL

---

9. After Bid is awarded and successful awarded contractor(s) default(s) in meeting the general instructions to bidder(s) and/or compiling with Bid agreement, Hidalgo County reserves the right to seek services from the next low bidder. In such event, County shall charge the successful bidder the difference for any additional cost to such item.
10. Hidalgo County reserves the right to seek purchases from State awarded vendors or any other Cooperative Purchasing programs, whenever it is in the best interest of the County to do so.
11. Insurance requirements for this project to be maintained throughout the contract term (Refer to limits on the Exhibit "C" for limits); insurance certificate must be submitted to the Purchasing Department prior to any services being performed by the awarded bidder.
12. The bidder(s) awarded the contract **cannot** engage the services of a **subcontractor without prior written consent of Hidalgo County** to perform services hereunder. The successful bidder(s) must present evidence that the proposed subcontractor possess all the necessary licenses and permits to perform the services and that subcontractor has obtained the required insurance.
13. Bidder(s) agree that to the extent an item(s) is unavailable for Bidder's own inventory, Bidder(s) will be responsible for locating an alternative supplier and for providing the product or service to Hidalgo County.
14. Unit prices quoted shall remain firm for the period of the contract and shall include the cost of shipping and delivery of all items to the designated FOB point and must include any and all cost in the delivered unit price.

All costs and expenses associated with the preparation and submission of proposals shall be the responsibility of the submitter and no reimbursements for such charges or expenses shall be passed onto the County.

**Market Volatility and Unit Price Adjustments:**

Hidalgo County recognizes that during periods of national crisis and unstable economic conditions, unforeseen price increases might affect costs for goods and services contracted on an annual basis. The following procedure may be employed to mediate price volatility:

- **Requesting Price Adjustment:** Upon written request of the Vendor to the County Purchasing Agent, the County may review evidence of prevailing industry-wide market conditions that warrant an adjustment in bid prices contained in the contract.
- A Vendor must tie any price change clause to an industry-wide or otherwise nationally recognized index, or some other form of verifiable document. Such written request must be accompanied by a certified copy of the supplier's advisory or notification to the vendor of the price changes.
- The Vendor must put the Purchasing Agent on the mailing lists for such publications so that the Purchasing Agent can monitor said changes. Such membership shall be at no cost to the County.
- The County Purchasing Agent retains the right to determine whether or not such proposed price changes are in the best interest of the County.
- No price escalation will be authorized in excess of the amount of the increase referred to in the supplier's notice.
- The County may only grant a price increase if the evidence presented is deemed reliable. Should the County allow a price increase, the approved price change shall be honored for all orders received by the vendor or contractor after the effective date of such price change. Approved price changes are not applicable to orders already issued and in process at time of price change.
- **Price Reduction:** Vendor shall notify the County at the time when the Vendor's costs for items and/or supplies reduce due to stabilization in the market at which time prices for items on this contract shall be reduced accordingly. Failure by the Vendor to notify the County of a decrease in costs for items and/or supplies for which the Vendor was granted a price adjustment, may result in immediate termination of this contract and the County shall not be obligated to pay the Vendor the difference between the contract price and the price adjustment.

EXHIBIT "A"  
SPECIFICATIONS  
HIDALGO COUNTY (All funding sources, programs & entities)  
"PIPES & Related Miscellaneous Items"  
RFB No.: 2019-100-05-15-TDL

---

**Time Frame for Adjusted Price Increases:** Price increases are only valid for the quarter in which they are requested and approved. Prices shall return to the original contract price at the beginning of the following quarter unless a Vendor notifies the County in writing within ten (10) days of expiration of the quarter in which the price increase is in effect, that it desires to have the price increase continue or that the Vendor is requesting a different price increase for the following quarter. Such request must be supplemented with sufficient justification to demonstrate that the price increase remains necessary. The County Purchasing Department shall have sole discretion whether to grant the price increase extension. The County too, shall have discretion to unilaterally reduce, eliminate or extend a price adjustment to the Vendor at any time upon written notice from the County to the Vendor demonstrating justification for such reduction, elimination or extension of the price adjustment.

**Allowable Review Periods:** Price adjustment reviews may only be requested by the Vendor on a quarterly basis. However, the County may at its own discretion, conduct temporary price adjustment reviews at any time. The County Purchasing Agent and/or the County Auditor reserve the right to audit and/or examine any pertinent books, documents, papers, records or invoices relating directly to the contract transaction in question after reasonable notice and during normal business hours.

**Dollar Limit to Price Changes:** The total increase in contract price shall not exceed twenty-five percent (25%) of the original contract price during the contract term.

**ADDITIONAL INFORMATION**

Hidalgo County is requesting that any and all questions, inquiries, and clarifications regarding quotes, bids, proposals, or statements of qualifications be addressed to, Martha L. Salazar, CPPB, Purchasing Agent, 2812 S. Business Hwy. 281, Edinburg, Texas 78539. **TELEPHONE INQUIRIES WILL NOT BE ACCEPTED.**

All written inquiries will be accepted via facsimile (956) 292-7612 or via e-mail to [tanya.delira@co.hidalgo.tx.us](mailto:tanya.delira@co.hidalgo.tx.us) by no later than, Monday, May 06, 2019 by 5:00 p.m. Responses to said inquiries will be sent to all applicants via-email by no later than Wednesday, May 08, 2019 by 5:00 p.m.

**EXHIBIT "B" – BID PAGE**  
**Hidalgo County (All funding sources, programs & entities)**  
**"PIPES & Related Miscellaneous Items"**  
**RFB No.: 2019-100-05-15-TDL**

**CATEGORY (A) – PIPES**

<b>CORRUGATED POLYVINYL CHLORIDE (PVC) STORM SEWER PIPE</b>		
NIGP CODE: 665-89 Polyvinyl Chloride (PVC)		
DESCRIPTION	PRICE	
12"		LF
15"		LF
18"		LF
24"		LF
30"		LF
36"		LF
42"		LF
48"		LF

<b>CORRUGATED STEEL STORM SEWER PIPE</b>			
NIGP CODE: 210-29 Corrugated Galvanized Metal Pipe			
(UNIT PRICE INCLUDES ONE GASKETED BAND CONNECTION FOR EVERY 20 FOOT JOINT)			
DIAMETER	TYPE "IR" PIPE PRICE	TYPE "I" PIPE PRICE	TYPE "IA" PIPE PRICE
12"			LF
15"			LF
18"			LF
24"			LF
30"			LF
36"			LF
42"			LF
48"			LF
54"			LF
60"			LF
66"			LF
72"			LF
78"			LF
84"			LF
90"			LF
96"			LF
102"			LF
108"			LF
114"			LF
120"			LF
126"			LF
132"			LF
138"			LF
144"			LF

**EXHIBIT "B" – BID PAGE**  
**Hidalgo County (All funding sources, programs & entities)**  
**"PIPES & Related Miscellaneous Items"**  
**RFB No.: 2019-100-05-15-TDL**

<b>REINFORCED CONCRETE PIPE – RUBBER GASKET JOINT PIPE</b>						
NIGP CODE: 658-68						
DESCRIPTION	CLASS III PRICE		CLASS IV PRICE		CLASS V PRICE	
12"		LF		LF		LF
15"		LF		LF		LF
18"		LF		LF		LF
24"		LF		LF		LF
30"		LF		LF		LF
36"		LF		LF		LF
42"		LF		LF		LF
48"		LF		LF		LF
54"		LF		LF		LF
60"		LF		LF		LF
72"		LF		LF		LF

<b>REINFORCED CONCRETE PIPE – TONGUE &amp; GROOVE PIPE</b>						
NIGP CODE: 658-68						
DESCRIPTION	CLASS III PRICE		CLASS IV PRICE		CLASS V PRICE	
12"		LF		LF		LF
15"		LF		LF		LF
18"		LF		LF		LF
24"		LF		LF		LF
30"		LF		LF		LF
36"		LF		LF		LF
42"		LF		LF		LF
48"		LF		LF		LF
54"		LF		LF		LF
60"		LF		LF		LF
72"		LF		LF		LF

<b>REINFORCED POLYTHYLENE PIPE – 20 FOOT JOINTS</b>		
NIGP CODE: 658-58		
DESCRIPTION	PRICE	
24"		LF
30"		LF
36"		LF
42"		LF
48"		LF
54"		LF
60"		LF
72"		LF
84"		LF
96"		LF

**EXHIBIT "B" – BID PAGE**  
**Hidalgo County (All funding sources, programs & entities)**  
**"PIPES & Related Miscellaneous Items"**  
**RFB No.: 2019-100-05-15-TDL**

<b>AWWA C900 PVC PLASTIC PRESSURE PIPE</b>					
NIGP CODE: 658-56 PLASTIC PIPES OR					
NIGP CODE: 658-60 PVC PIPES					
DESCRIPTION	DR 14 PRICE		DR 18 PRICE		DR 25 PRICE
4"		LF		LF	LF
6"		LF		LF	LF
8"		LF		LF	LF
10"		LF		LF	LF
12"		LF		LF	LF

<b>AWWA C905 PVC PLASTIC WATER PIPE</b>									
NIGP CODE: 658-56 PLASTIC PIPES OR									
NIGP CODE: 658-60 PVC PIPES									
DESCRIPTION	DR 18 PRICE		DR 25 PRICE		DR 32.5 PRICE		DR 41 PRICE		DR 51 PRICE
14"		LF		LF		LF		LF	LF
16"		LF		LF		LF		LF	LF
18"		LF		LF		LF		LF	LF
24"		LF		LF		LF		LF	LF
30"		LF		LF		LF		LF	LF
36"		LF		LF		LF		LF	LF
42"		LF		LF		LF		LF	LF
48"		LF		LF		LF		LF	LF

<b>SDR 26 AND SDR 35 GASKETED GRAVITY SANITARY SEWER PIPE</b>				
NIGP CODE: 210-35				
SEWER PIPE JOINT SEALING COMPOUND				
SIZE OF PIPE	SDR 26		SDR 35	
4"		LF		LF
6"		LF		LF
8"		LF		LF
10"		LF		LF
12"		LF		LF
15"		LF		LF

<b>HIGH PERFORMANCE (HP) POLYPROPYLENE STORM PIPE</b>		
DESCRIPTION	PRICE	
12"		LF
15"		LF
18"		LF
24"		LF
30"		LF
36"		LF
42"		LF
48"		LF
60"		LF

**EXHIBIT "B" – BID PAGE**  
**Hidalgo County (All funding sources, programs & entities)**  
**"PIPES & Related Miscellaneous Items"**  
**RFB No.: 2019-100-05-15-TDL**

<b>HIGH DESTINY POLYETHYLENE PIPE (HDPE)</b>		
NIGP CODE: 658-58 Polyethylene Pipe And Fitting		
DESCRIPTION	PRICE	
4"		LF
6"		LF
8"		LF
10"		LF
12"		LF
15"		LF
18"		LF
24"		LF
30"		LF
36"		LF
42"		LF
48"		LF
54"		LF
60"		LF

<b>PLUMBING PIPES – 20 FOOT SECTIONS</b>		
NIGP CODE: 967-60		
PVC	PRICE	
1/2"		
1 1/2"		
2"		
3"		
4"		

<b>PLUMBING PIPES – 20 FOOT SECTIONS</b>		
NIGP CODE: 967-60		
COPPER	PRICE	
1/2"		
3/4"		

**EXHIBIT "B" – BID PAGE**  
**Hidalgo County (All funding sources, programs & entities)**  
**"PIPES & Related Miscellaneous Items"**  
**RFB No.: 2019-100-05-15-TDL**

**CATEGORY (B) – INLETS**  
 NIGP CODE: 210-31  
**INLETS, AREA, SEWER DRAIN, PRECAST, CONCRETE, STORM DRAIN, NO BOTTOM FLOORS**

DESCRIPTION	PRICE																	
	2'	2 1/2'	3'	3 1/2'	4'	4 1/2'	5'	5 1/2'	6'	6 1/2'	7'	7 1/2'	8'	8 1/2'	9'	9 1/2'	10'	
Type "A" Inlet (5' x 3')																		
Type "A-1" Inlet (5' x 4')																		
Type "A-2" Inlet (5' x 5')																		
Type "A-3" Inlet (5' x 6')																		
Type "A" (SPL-1) Inlet (5' x 3')																		
Type "A-1" (SPL-1) Inlet (5' x 4')																		
Type "A-2" (SPL-1) Inlet (5' x 5')																		
Type "A-3" (SPL-1) Inlet (5' x 6')																		
TYPE "C" INLET 2' X 2'																		
TYPE "C" INLET 3' X 3'																		
TYPE "C" INLET 4' X 4'																		
TYPE "CC" INLET 5' X 3'																		

**EXHIBIT "B" - BID PAGE**  
**Hidalgo County (All funding sources, programs & entities)**  
**"PIPES & Related Miscellaneous Items"**  
**RFB No.: 2019-100-05-15-TDL**

Type "F" Inlet (W=3')																				
Type "F-1" Inlet (W=4')																				
Type "F-2" Inlet (W=5')																				
Type "F-3" Inlet (W=6')																				
Type "F" (SPL-1) Inlet (W=3')																				
Type "F-1" (SPL-1) Inlet (W=4')																				
Type "F-2" (SPL-1) Inlet (W=5')																				
Type "F-3" (SPL-1) Inlet (W=6')																				

**CATEGORY (C) - MANHOLES, NO BOTTOM FLOORS**  
**NIGP CODE: 890-30**  
**MANHOLES**

DESCRIPTION	PRICE														
	3'	3 1/2'	4'	4 1/2'	5'	5 1/2'	6'	6 1/2'	7'	7 1/2'	8'	8 1/2'	9'	9 1/2'	10'
TYPE "A" MANHOLE															
TYPE "A-1" MANHOLE															
TYPE "M" MANHOLE															

**EXHIBIT "B" – BID PAGE**  
**Hidalgo County (All funding sources, programs & entities)**  
**"PIPES & Related Miscellaneous Items"**  
**RFB No.: 2019-100-05-15-TDL**

**CATEGORY (D) – MISCELLANEOUS**

DESCRIPTION		
WATER VALVE	UNIT	PRICE
2"	EA	
4"	EA	
6"	EA	
8"	EA	
10"	EA	
<b>90 DEGREE ELBOW</b>		
2"	EA	
4"	EA	
6"	EA	
8"	EA	
10"	EA	
<b>45 DEGREE ELBOW</b>		
2"	EA	
4"	EA	
6"	EA	
8"	EA	
10"	EA	
<b>STEEL PIPE CASING WITH SPACERS</b>		
4"	LF	
6"	LF	
12"	LF	
16"	LF	
24"	LF	
<b>FIRE HYDRANT W/VALVE</b>		
	EA	
<b>PVC SCHEDULE 40 WATER LINE DR 18</b>		
2"	LF	
8"	LF	
<b>PVC SCHEDULE 40</b>		
1.5"	LF	
0.75"	LF	
0.5"	LF	
<b>WATER SADDLE W/2' CORPORATE VALVE</b>		
8" x 2"	EA	

**EXHIBIT "B" – BID PAGE**  
**Hidalgo County (All funding sources, programs & entities)**  
**"PIPES & Related Miscellaneous Items"**  
**RFB No.: 2019-100-05-15-TDL**

<b>HP Dual Wall Marmac Couplers</b>		
<b>PIPE SIZE</b>	<b>PRICE</b>	<b>UNIT</b>
12"		EA
15"		EA
18"		EA
24"		EA
30"		EA
36"		EA
42"		EA
48"		EA
60"		EA

<b>HP Dual Wall Fabricated Tees</b>		
<b>PIPE SIZE</b>	<b>PRICE</b>	<b>UNIT</b>
12"		EA
15"		EA
18"		EA
24"		EA
30"		EA
36"		EA
42"		EA
48"		EA
60"		EA

<b>HP Dual Wall Fabricated Bends</b>						
<b>PIPE SIZE</b>	<b>11.25 Bend</b>	<b>22.5 Bend</b>	<b>30* Bend</b>	<b>45* Bend</b>	<b>90* Bend</b>	<b>Unit</b>
12"						EA
15"						EA
18"						EA
24"						EA
30"						EA
36"						EA
42"						EA
48"						EA
60"						EA

**EXHIBIT "B" – BID PAGE**  
**Hidalgo County (All funding sources, programs & entities)**  
**"PIPES & Related Miscellaneous Items"**  
**RFB No.: 2019-100-05-15-TDL**

---

---

**BIDDER/COMPANY NAME:** \_\_\_\_\_

**ADDRESS:** \_\_\_\_\_

**CITY:** \_\_\_\_\_ **STATE:** \_\_\_\_\_ **ZIPCODE:** \_\_\_\_\_

**PHONE No:** \_\_\_\_\_ **FAX No:** \_\_\_\_\_ **CELL No** \_\_\_\_\_

**AUTHORIZED SIGNATURE:** \_\_\_\_\_

**PRINTED NAME:** \_\_\_\_\_

**TITLE:** \_\_\_\_\_ **DATE:** \_\_\_\_\_

**EMAIL:** \_\_\_\_\_

# EXHIBIT "C"

## Insurance Requirements Professional Services (i.e...Engineers, Architects, Appraisers & Surveyors)

The proposer awarded the contract shall furnish proof of insurance, which will also include any subcontractor that is subcontracted by the proposer in at least the following limits, to be in place prior to providing any services under this Contract and to continue at all times in force in effect during the term of this Contract:

1. Professional liability insurance policy with limits of at least One Million Dollars (\$1,000,000) per occurrence, or limited to claims made, include at least a five (5) year extended reporting period.
2. A Five Hundred Thousand Dollars (\$500,000.00) Comprehensive General Liability insurance policy providing additional coverage to all underlying liabilities of County.
3. Automobile liability insurance policy with limits of at least Three Hundred Thousand Dollars (\$300,000.00) per person and Five Hundred Thousand Dollars (\$500,000.00) per occurrence. Coverage should include injury to or death of persons and property damage claims with limits up to Five Hundred Thousand Dollars (\$500,000.00) arising out of the services provided to County hereunder.
4. Uninsured/Underinsured motorist coverage in an amount equal to the bodily injury limits set forth immediately above;
5. Workers compensation insurance in amounts established by Texas law, unless the Bidder is specifically exempted from the Texas Workers Compensation Act, Texas Labor Code Chapter 401, et. seq.

**Hidalgo County will only accept certificates of insurance on an Acord form (as attached hereto).** Certificates of insurance naming County as an additional insured shall be submitted to County for approval prior to any services being performed by Contractor. Each policy of insurance required hereunder shall extend for a period equivalent to, or longer than the term of the Contract, and any insurer hereunder shall be required to give at least thirty (30) days written notice to the County prior to the cancellation of any such coverage on the termination date, or otherwise. This Contract shall be automatically suspended upon the cancellation, or other termination, of any required policy of insurance hereunder, and such suspension shall continue until evidence adequate replacement coverage is provided to County. If replacement coverage is not provided within thirty (30) days following suspension of the Contract, this Contract shall automatically terminate.

<b>ACORD</b>		<b>CERTIFICATE OF INSURANCE</b>	DATE (MM/DD/YY)
PRODUCER		THIS CERTIFICATE IS ISSUED AS A MATTER OF INFORMATION ONLY AND CONFERS NO RIGHTS UPON THE CERTIFICATE HOLDER. THIS CERTIFICATE DOES NOT AMEND, EXTEND OR ALTER THE COVERAGE AFFORDED BY THE POLICIES BELOW.	
INSURED		<b>INSURERS AFFORDING COVERAGE</b>	
		INSURER A:	
		INSURER B:	
		INSURER C:	
		INSURER D:	
		INSURER E:	

**COVERAGES**

THE POLICIES OF INSURANCE LISTED BELOW HAVE BEEN ISSUED TO THE INSURED NAMED ABOVE FOR THE POLICY PERIOD INDICATED. NOTWITHSTANDING ANY REQUIREMENT, TERM OR CONDITION OF ANY CONTRACT OR OTHER DOCUMENT WITH RESPECT TO WHICH THIS CERTIFICATE MAY BE ISSUED OR MAY PERTAIN, THE INSURANCE AFFORDED BY THE POLICIES DESCRIBED HEREIN IS SUBJECT TO ALL THEIR TERMS, EXCLUSIONS AND CONDITIONS OF SUCH POLICIES. AGGREGATE LIMITS SHOWN MAY HAVE BEEN REDUCED BY PAID CLAIMS.

INSR LTR	TYPE OF INSURANCE	POLICY NUMBER	POLICY EFFECTIVE DATE (MM/DD/YY)	POLICY EXPIRATION DATE (MM/DD/YY)	LIMITS
A	<b>GENERAL LIABILITY</b>				EACH OCCURRENCE \$
	<input type="checkbox"/> COMMERCIAL GENERAL LIABILITY				PHYSICAL DAMAGE (Any one Proj) \$
	<input type="checkbox"/> CLAIMS MADE OCCUR				MED (Any one person) \$
	<input type="checkbox"/> OWNER'S & CONT. PROT.				PERSONAL & ADV. INJURY \$
	<input type="checkbox"/> OWNER'S PROTECTIVE LIABILITY				ANNUAL AGGREGATE \$
	<input type="checkbox"/> GEN'L AGGREGATE LIMIT APPLIES PER POLICY PROJECT <input type="checkbox"/> LOC.				PRODUCTS - COMP/OP AGG \$
B	<b>AUTOMOBILE LIABILITY</b>				COMBINED SINGLE LIMIT (EA accident) \$
	<input type="checkbox"/> ANY AUTO				BODILY INJURY (Per person) \$
	<input type="checkbox"/> ALL OWNED AUTOS				BODILY INJURY (Per accident) \$
	<input type="checkbox"/> SCHEDULED AUTOS				PROPERTY DAMAGE (Per accident) \$
	<b>GARAGE LIABILITY</b>				AUTO ONLY EA ACCIDENT \$
	<input type="checkbox"/> MY AUTO				OTHER THAN AUTO ONLY EA ACC AGG \$
					\$
C	<b>EXCESS LIABILITY</b>				EACH OCCURRENCE \$
	<input type="checkbox"/> OCCUR <input type="checkbox"/> CLAIMS MADE				AGGREGATE \$
	<input type="checkbox"/> DEDUCTIBLE \$				\$
D	<b>WORKERS COMPENSATION AND EMPLOYER'S LIABILITY</b>				WC STATE <input type="checkbox"/> OTHER TORY LIMITS
					E.L. EACH ACCIDENT \$
					E.L. DISEASE EA EMPLOYEE \$
	<b>OTHER</b>				E.L. DISEASE POLICY LIMIT \$
DESCRIPTION OF OPERATIONS / LOCATION / VEHICLES / EXCLUSIONS ADDED BY ENDORSEMENT / SPECIAL PROVISIONS					
County of Hidalgo shall be named as additional insured on all Commercial General Liability policies.					
CERTIFICATE HOLDER		ADDITIONAL INSURED; INSURER LETTER:		CANCELLATION	
Hidalgo County Attn: Purchasing Department 2812 S Highway Bus. 281 Edinburg, Texas 78539				SHOULD ANY OF THE ABOVE DESCRIBED POLICIES BE CANCELLED BEFORE THE EXPIRATION DATE THEREOF, THE ISSUING INSURER WILL ENDEAVOR TO MAIL 30 DAYS WRITTEN NOTICE TO THE CERTIFICATE HOLDER NAMED TO THE LEFT, BUT FAILURE TO DO SO SHALL IMPOSE NO OBLIGATION OR LIABILITY OF ANY KIND UPON THE INSURER, ITS AGENTS OR REPRESENTATIVES.	
		AUTHORIZED REPRESENTATIVE			

# Insurance Requirement Acknowledgment

I, \_\_\_\_\_, authorized representative for \_\_\_\_\_,  
Company/Vendor

hereby acknowledge receipt of the County's required insurance limits. Said requirements:

- will be acquired within 10 working days after notification from Purchasing Department of award of project by the Hidalgo County Commissioners' Court;
- will acquire additional amounts required to meet the County's requirements within 10 working days after notification from Purchasing Department of award of project by the Hidalgo County Commissioners' Court; currently carry the following

Professional Liability (Errors & Omissions): \$ \_\_\_\_\_

Automobile Liability: \$ \_\_\_\_\_ General Liability: \$ \_\_\_\_\_

- have already been met, see attached copy of insurance certificate.

\_\_\_\_\_  
Authorized Representative

\_\_\_\_\_  
Date

### Notice to Proposer:

A certificate of insurance for the required insurance limits shall be provided to the Purchasing Department's Contract Managers in order to qualify for award and to execute a contract between your Company and the County

Failure to provide Certificates of Insurance to the Purchasing Department's Contract Managers will cause the award to be rescinded and re-awarded to next qualified vendor. Certificates of Insurance will be monitored and verified on a **quarterly basis** to ensure coverage policy is in place. It is the Company's obligation to maintain the appropriate insurance coverage throughout the term of the contract.

**THIS FORM MUST ACCOMPANY YOUR PACKET**

## PROJECT REQUIREMENTS ACKNOWLEDGMENT

This is to certify that I, \_\_\_\_\_, possess all of the **APPLICABLE**:

1. Licenses: \_\_\_\_\_
2. Bonds: \_\_\_\_\_
3. Certificates: \_\_\_\_\_
4. Permits: \_\_\_\_\_
5. Other: \_\_\_\_\_

necessary to carry out the required project. Furthermore, I am providing copies of the required documentation so that, if my company is awarded this project, I may be eligible to enter into a contract with Hidalgo County and proceed to complete the project in a timely manner.

**\* Any licenses, bonds, certificates, permits, etc. which are required must be presented as part of the packet in order to expedite the evaluation process. Failure to provide said documentation will result in the disqualification of your proposal/qualification.**

\_\_\_\_\_  
Authorized Signature

\_\_\_\_\_  
Date

\_\_\_\_\_  
Company

\_\_\_\_\_  
Address

\_\_\_\_\_  
City, State, Zip

EXHIBIT "D"

CIQ

Conflict of Interest

Questionnaire

# CONFLICT OF INTEREST QUESTIONNAIRE

## FORM CIQ

For vendor doing business with local governmental entity

This questionnaire reflects changes made to the law by H.B. 23, 84th Leg., Regular Session.

This questionnaire is being filed in accordance with Chapter 176, Local Government Code, by a vendor who has a business relationship as defined by Section 176.001(1-a) with a local governmental entity and the vendor meets requirements under Section 176.006(a).

By law this questionnaire must be filed with the records administrator of the local governmental entity not later than the 7th business day after the date the vendor becomes aware of facts that require the statement to be filed. See Section 176.006(a-1), Local Government Code.

A vendor commits an offense if the vendor knowingly violates Section 176.006, Local Government Code. An offense under this section is a misdemeanor.

### OFFICE USE ONLY

Date Received

1 Name of vendor who has a business relationship with local governmental entity.

2  Check this box if you are filing an update to a previously filed questionnaire. (The law requires that you file an updated completed questionnaire with the appropriate filing authority not later than the 7th business day after the date on which you became aware that the originally filed questionnaire was incomplete or inaccurate.)

3 Name of local government officer about whom the information is being disclosed.

\_\_\_\_\_  
Name of Officer

4 Describe each employment or other business relationship with the local government officer, or a family member of the officer, as described by Section 176.003(a)(2)(A). Also describe any family relationship with the local government officer. Complete subparts A and B for each employment or business relationship described. Attach additional pages to this Form CIQ as necessary.

A. Is the local government officer or a family member of the officer receiving or likely to receive taxable income, other than investment income, from the vendor?

Yes  No

B. Is the vendor receiving or likely to receive taxable income, other than investment income, from or at the direction of the local government officer or a family member of the officer AND the taxable income is not received from the local governmental entity?

Yes  No

5 Describe each employment or business relationship that the vendor named in Section 1 maintains with a corporation or other business entity with respect to which the local government officer serves as an officer or director, or holds an ownership interest of one percent or more.

6  Check this box if the vendor has given the local government officer or a family member of the officer one or more gifts as described in Section 176.003(a)(2)(B), excluding gifts described in Section 176.003(a-1).

7

\_\_\_\_\_  
Signature of vendor doing business with the governmental entity

\_\_\_\_\_  
Date

**CONFLICT OF INTEREST QUESTIONNAIRE**  
**For vendor doing business with local governmental entity**

A complete copy of Chapter 176 of the Local Government Code may be found at <http://www.statutes.legis.state.tx.us/Docs/LG/htm/LG.176.htm>. For easy reference, below are some of the sections cited on this form.

**Local Government Code § 176.001(1-a):** "Business relationship" means a connection between two or more parties based on commercial activity of one of the parties. The term does not include a connection based on:

- (A) a transaction that is subject to rate or fee regulation by a federal, state, or local governmental entity or an agency of a federal, state, or local governmental entity;
- (B) a transaction conducted at a price and subject to terms available to the public; or
- (C) a purchase or lease of goods or services from a person that is chartered by a state or federal agency and that is subject to regular examination by, and reporting to, that agency.

**Local Government Code § 176.003(a)(2)(A) and (B):**

(a) A local government officer shall file a conflicts disclosure statement with respect to a vendor if:

\*\*\*

(2) the vendor:

(A) has an employment or other business relationship with the local government officer or a family member of the officer that results in the officer or family member receiving taxable income, other than investment income, that exceeds \$2,500 during the 12-month period preceding the date that the officer becomes aware that

(i) a contract between the local governmental entity and vendor has been executed;  
or

(ii) the local governmental entity is considering entering into a contract with the vendor;

(B) has given to the local government officer or a family member of the officer one or more gifts that have an aggregate value of more than \$100 in the 12-month period preceding the date the officer becomes aware that:

- (i) a contract between the local governmental entity and vendor has been executed; or
- (ii) the local governmental entity is considering entering into a contract with the vendor.

**Local Government Code § 176.006(a) and (a-1)**

(a) A vendor shall file a completed conflict of interest questionnaire if the vendor has a business relationship with a local governmental entity and:

(1) has an employment or other business relationship with a local government officer of that local governmental entity, or a family member of the officer, described by Section 176.003(a)(2)(A);

(2) has given a local government officer of that local governmental entity, or a family member of the officer, one or more gifts with the aggregate value specified by Section 176.003(a)(2)(B), excluding any gift described by Section 176.003(a-1); or

(3) has a family relationship with a local government officer of that local governmental entity.

(a-1) The completed conflict of interest questionnaire must be filed with the appropriate records administrator not later than the seventh business day after the later of:

(1) the date that the vendor:

(A) begins discussions or negotiations to enter into a contract with the local governmental entity; or

(B) submits to the local governmental entity an application, response to a request for proposals or bids, correspondence, or another writing related to a potential contract with the local governmental entity; or

(2) the date the vendor becomes aware:

(A) of an employment or other business relationship with a local government officer, or a family member of the officer, described by Subsection (a);

(B) that the vendor has given one or more gifts described by Subsection (a); or

(C) of a family relationship with a local government officer.

# Exhibit "E"

Vendor/Bidder  
Application

W9

HUB/DBE

HIDALGO COUNTY  
PURCHASING DEPARTMENT  
Proposer/Vendor Application

Complete in print or type. Please return this application to the Hidalgo County Purchasing Department  
thru Facsimile: (956) 318-2629 or (956) 292-7612  
in person or regular mail to:  
Mailing/Postal Address: 2812 S. Business Hwy. 281  
Physical Address: 2802 S. Business Hwy. 281  
Edinburg, Texas 78539  
or e-mail: purchasing@co.hidalgo.tx.us

Company Name:	Telephone No. ( )
dba Name:	
Legal Name:	
Mailing Address:	Fax No. ( )
Physical Address:	
City, State, Zip	Tnx I.D. No.
Remit to Address :	City, State, Zip
E-Mail Address:	
Representative(s) Name(s) & Title(s)	
Type of Organization (check one):	<input type="checkbox"/> Individual <input type="checkbox"/> Partnership <input type="checkbox"/> Corporation <input type="checkbox"/> Non-Profit <input type="checkbox"/> LLC <input type="checkbox"/> Sole Proprietor <input type="checkbox"/> Other, Specify
State Identification No. _____	(Please attach completed W-9 form with this application) Federal Identification No. or (if individual) SS No.
State of Incorporation: _____	Date: _____ Other: _____
Type of Business (check one):	<input type="checkbox"/> Manufacturer <input type="checkbox"/> Wholesaler <input type="checkbox"/> Retailer <input type="checkbox"/> Broker <input type="checkbox"/> Distributor <input type="checkbox"/> Service Organization <input type="checkbox"/> Other, Specify
Name & Title of Person(s) Authorized to Sign Bids, Proposals, and/or Contracts:	
<u>Small and/or Disadvantaged Business Information (check application criteria)</u> Small Business: _____ Disadvantaged Business (At Least 51% Ownership)	
<input type="checkbox"/> Less than 125,000 annual gross receipt	<input type="checkbox"/> Black American <input type="checkbox"/> Native American
<input type="checkbox"/> Less than 250,000 annual gross receipt	<input type="checkbox"/> Hispanic American <input type="checkbox"/> Women
<input type="checkbox"/> Less than 499,000 annual gross receipt	<input type="checkbox"/> Asian Pacific American <input type="checkbox"/> Other
<input type="checkbox"/> More than 500,000 annual gross receipt	
Have you been certified as a HUB or an MBE/WBE source?: _____	<input type="checkbox"/> Yes <input type="checkbox"/> No
Indicate Certification No.(s): _____	or are Certificate(s) attached?: <input type="checkbox"/> Yes <input type="checkbox"/> No
What type of product(s) is/are sold/ed by your company?:	
Would you like to be provided with specifications for procurements of such products?: <input type="checkbox"/> Yes <input type="checkbox"/> No	
To Be Completed by the County: Rec'd by (Purchasing): _____ Date Rec'd by (Purchasing):	
Date Forwarded Information to Auditor's Office: _____ Entry Date: _____ Vendor No.:	

(THIS PAGE MUST BE SUBMITTED WITH PROPOSAL)

**HISTORICALLY UNDERUTILIZED BUSINESS (HUB) DECLARATION**

The primary objective of the Hidalgo County HUB Program is to ensure Historically Underutilized Businesses receive a fair and equal opportunity for participation in the County's procurement process. This fact holds true for Services (Professional & Non-Professional), Commodities, and Construction contracts and any subcontracts thereto. The program strongly encourages Prime Contractors to provide subcontracting opportunities to Certified Hub Contractors/Vendors. Our goal for HUB contractor/vendor participation, as well as HUB subcontractor participation is 30%. To be considered as a "Certified HUB Contractor/Vendor" the contractor/vendor must have been certified by, and hold a current and valid certification with any of the three agencies listed below.

Have you been Certified as a HUB or an MBE/WBB source?:  Yes  No

If yes, by whom?:  Texas Building & Procurement Commission  Other \_\_\_\_\_

Indicate Certification No(s): \_\_\_\_\_ or Are Certificate(s) Attached?:  Yes  No

**LIST OF CERTIFIED HUB SUBCONTRACTORS**

(Attach additional pages if necessary)

---

What percentage of the Bid, RFP, or RFQ is to be subcontracted with Certified HUB sources?: \_\_\_\_\_ %  
(List HUB Subcontractor information below).

HUB Subcontractor Name: \_\_\_\_\_ HUB Status: \_\_\_\_\_  
Certifying Agency (Check all applicable):  Texas Building & Procurement Commission  other  
Address: \_\_\_\_\_ City: \_\_\_\_\_ State: \_\_\_\_\_ Zip: \_\_\_\_\_  
Contact Person: \_\_\_\_\_ Title: \_\_\_\_\_ Phone No.: ( ) \_\_\_\_\_  
Subcontract Amount: \$ \_\_\_\_\_ Description of Work to be Performed: \_\_\_\_\_

---

HUB Subcontractor Name: \_\_\_\_\_ HUB Status: \_\_\_\_\_  
Certifying Agency (Check all applicable):  Texas Building & Procurement Commission  other  
Address: \_\_\_\_\_ City: \_\_\_\_\_ State: \_\_\_\_\_ Zip: \_\_\_\_\_  
Contact Person: \_\_\_\_\_ Title: \_\_\_\_\_ Phone No.: ( ) \_\_\_\_\_  
Subcontract Amount: \$ \_\_\_\_\_ Description of Work to be Performed: \_\_\_\_\_

---

HUB Subcontractor Name: \_\_\_\_\_ HUB Status: \_\_\_\_\_  
Certifying Agency (Check all applicable):  Texas Building & Procurement Commission  other  
Address: \_\_\_\_\_ City: \_\_\_\_\_ State: \_\_\_\_\_ Zip: \_\_\_\_\_  
Contact Person: \_\_\_\_\_ Title: \_\_\_\_\_ Phone No.: ( ) \_\_\_\_\_  
Subcontract Amount: \$ \_\_\_\_\_ Description of Work to be Performed: \_\_\_\_\_

---

**(THIS PAGE MUST BE SUBMITTED WITH PROPOSAL)**

# Request for Taxpayer Identification Number and Certification

Give Form to the  
requester. Do not  
send to the IRS.

Go to [www.irs.gov/FormW9](http://www.irs.gov/FormW9) for instructions and the latest information.

Print or type.  
See Specific Instructions on page 3.

1 Name (as shown on your Income tax return). Name is required on this line; do not leave this line blank.	
2 Business name/disregarded entity name, if different from above	
3 Check appropriate box for federal tax classification of the person whose name is entered on line 1. Check only one of the following seven boxes. <input type="checkbox"/> Individual/sole proprietor or single-member LLC <input type="checkbox"/> Limited liability company. Enter the tax classification (C=C corporation, S=S corporation, P=Partnership) ▶ _____ Note: Check the appropriate box in the line above for the tax classification of the single-member owner. Do not check LLC if the LLC is classified as a single-member LLC that is disregarded from the owner unless the owner of the LLC is another LLC that is not disregarded from the owner for U.S. federal tax purposes. Otherwise, a single-member LLC that is disregarded from the owner should check the appropriate box for the tax classification of its owner. <input type="checkbox"/> Other (see Instructions) ▶ _____	4 Exemptions (codes apply only to certain entities, not individuals; see instructions on page 3): Exempt payee code (if any) _____ Exemption from FATCA reporting code (if any) _____ <small>(Applies to accounts maintained outside the U.S.)</small>
5 Address (number, street, and apt. or suite no.) See Instructions.	Requester's name and address (optional)
6 City, state, and ZIP code	
7 List account number(s) here (optional)	

## Part I Taxpayer Identification Number (TIN)

Enter your TIN in the appropriate box. The TIN provided must match the name given on line 1 to avoid backup withholding. For individuals, this is generally your social security number (SSN). However, for a resident alien, sole proprietor, or disregarded entity, see the Instructions for Part I, later. For other entities, it is your employer identification number (EIN). If you do not have a number, see *How to get a TIN*, later.

Note: If the account is in more than one name, see the instructions for line 1. Also see *What Name and Number To Give the Requester* for guidelines on whose number to enter.

Social security number	
or	
Employer identification number	

## Part II Certification

Under penalties of perjury, I certify that:

- The number shown on this form is my correct taxpayer identification number (or I am waiting for a number to be issued to me); and
- I am not subject to backup withholding because: (a) I am exempt from backup withholding, or (b) I have not been notified by the Internal Revenue Service (IRS) that I am subject to backup withholding as a result of a failure to report all interest or dividends, or (c) the IRS has notified me that I am no longer subject to backup withholding; and
- I am a U.S. citizen or other U.S. person (defined below); and
- The FATCA code(s) entered on this form (if any) indicating that I am exempt from FATCA reporting is correct.

**Certification instructions.** You must cross out item 2 above if you have been notified by the IRS that you are currently subject to backup withholding because you have failed to report all interest and dividends on your tax return. For real estate transactions, item 2 does not apply. For mortgage interest paid, acquisition or abandonment of secured property, cancellation of debt, contributions to an individual retirement arrangement (IRA), and generally, payments other than interest and dividends, you are not required to sign the certification, but you must provide your correct TIN. See the instructions for Part II, later.

Sign Here	Signature of U.S. person ▶	Date ▶
-----------	----------------------------	--------

## General Instructions

Section references are to the Internal Revenue Code unless otherwise noted.  
**Future developments.** For the latest information about developments related to Form W-9 and its instructions, such as legislation enacted after they were published, go to [www.irs.gov/FormW9](http://www.irs.gov/FormW9).

## Purpose of Form

An individual or entity (Form W-9 requester) who is required to file an information return with the IRS must obtain your correct taxpayer identification number (TIN) which may be your social security number (SSN), individual taxpayer identification number (ITIN), adoption taxpayer identification number (ATIN), or employer identification number (EIN), to report on an information return the amount paid to you, or other amount reportable on an information return. Examples of information returns include, but are not limited to, the following.

- Form 1099-INT (interest earned or paid)

- Form 1099-DIV (dividends, including those from stocks or mutual funds)
  - Form 1099-MISC (various types of income, prizes, awards, or gross proceeds)
  - Form 1099-B (stock or mutual fund sales and certain other transactions by brokers)
  - Form 1099-S (proceeds from real estate transactions)
  - Form 1099-K (merchant card and third party network transactions)
  - Form 1098 (home mortgage interest), 1098-E (student loan interest), 1098-T (tuition)
  - Form 1099-C (canceled debt)
  - Form 1099-A (acquisition or abandonment of secured property)
- Use Form W-9 only if you are a U.S. person (including a resident alien), to provide your correct TIN.

If you do not return Form W-9 to the requester with a TIN, you might be subject to backup withholding. See *What Is backup withholding*, later.

By signing the filled-out form, you:

1. Certify that the TIN you are giving is correct (or you are waiting for a number to be issued),
2. Certify that you are not subject to backup withholding, or
3. Claim exemption from backup withholding if you are a U.S. exempt payee. If applicable, you are also certifying that as a U.S. person, your allocable share of any partnership income from a U.S. trade or business is not subject to the withholding tax on foreign partners' share of effectively connected income, and
4. Certify that FATCA code(s) entered on this form (if any) indicating that you are exempt from the FATCA reporting, is correct. See *What is FATCA reporting*, later, for further information.

**Note:** If you are a U.S. person and a requester gives you a form other than Form W-9 to request your TIN, you must use the requester's form if it is substantially similar to this Form W-9.

**Definition of a U.S. person.** For federal tax purposes, you are considered a U.S. person if you are:

- An individual who is a U.S. citizen or U.S. resident alien;
- A partnership, corporation, company, or association created or organized in the United States or under the laws of the United States;
- An estate (other than a foreign estate); or
- A domestic trust (as defined in Regulations section 301.7701-7).

**Special rules for partnerships.** Partnerships that conduct a trade or business in the United States are generally required to pay a withholding tax under section 1446 on any foreign partners' share of effectively connected taxable income from such business. Further, in certain cases where a Form W-9 has not been received, the rules under section 1446 require a partnership to presume that a partner is a foreign person, and pay the section 1446 withholding tax. Therefore, if you are a U.S. person that is a partner in a partnership conducting a trade or business in the United States, provide Form W-9 to the partnership to establish your U.S. status and avoid section 1446 withholding on your share of partnership income.

In the cases below, the following person must give Form W-9 to the partnership for purposes of establishing its U.S. status and avoiding withholding on its allocable share of net income from the partnership conducting a trade or business in the United States.

- In the case of a disregarded entity with a U.S. owner, the U.S. owner of the disregarded entity and not the entity;
- In the case of a grantor trust with a U.S. grantor or other U.S. owner, generally, the U.S. grantor or other U.S. owner of the grantor trust and not the trust; and
- In the case of a U.S. trust (other than a grantor trust), the U.S. trust (other than a grantor trust) and not the beneficiaries of the trust.

**Foreign person.** If you are a foreign person or the U.S. branch of a foreign bank that has elected to be treated as a U.S. person, do not use Form W-9. Instead, use the appropriate Form W-8 or Form 8233 (see Pub. 515, *Withholding of Tax on Nonresident Aliens and Foreign Entities*).

**Nonresident alien who becomes a resident alien.** Generally, only a nonresident alien individual may use the terms of a tax treaty to reduce or eliminate U.S. tax on certain types of income. However, most tax treaties contain a provision known as a "saving clause." Exceptions specified in the saving clause may permit an exemption from tax to continue for certain types of income even after the payee has otherwise become a U.S. resident alien for tax purposes.

If you are a U.S. resident alien who is relying on an exception contained in the saving clause of a tax treaty to claim an exemption from U.S. tax on certain types of income, you must attach a statement to Form W-9 that specifies the following five items.

1. The treaty country. Generally, this must be the same treaty under which you claimed exemption from tax as a nonresident alien.
2. The treaty article addressing the income.
3. The article number (or location) in the tax treaty that contains the saving clause and its exceptions.
4. The type and amount of income that qualifies for the exemption from tax.
5. Sufficient facts to justify the exemption from tax under the terms of the treaty article.

**Example.** Article 20 of the U.S.-China income tax treaty allows an exemption from tax for scholarship income received by a Chinese student temporarily present in the United States. Under U.S. law, this student will become a resident alien for tax purposes if his or her stay in the United States exceeds 5 calendar years. However, paragraph 2 of the first Protocol to the U.S.-China treaty (dated April 30, 1984) allows the provisions of Article 20 to continue to apply even after the Chinese student becomes a resident alien of the United States. A Chinese student who qualifies for this exception (under paragraph 2 of the first protocol) and is relying on this exception to claim an exemption from tax on his or her scholarship or fellowship income would attach to Form W-9 a statement that includes the information described above to support that exemption.

If you are a nonresident alien or a foreign entity, give the requester the appropriate completed Form W-8 or Form 8233.

## Backup Withholding

**What is backup withholding?** Persons making certain payments to you must under certain conditions withhold and pay to the IRS 24% of such payments. This is called "backup withholding." Payments that may be subject to backup withholding include interest, tax-exempt interest, dividends, broker and barter exchange transactions, rents, royalties, nonemployee pay, payments made in settlement of payment card and third party network transactions, and certain payments from fishing boat operators. Real estate transactions are not subject to backup withholding.

You will not be subject to backup withholding on payments you receive if you give the requester your correct TIN, make the proper certifications, and report all your taxable interest and dividends on your tax return.

**Payments you receive will be subject to backup withholding if:**

1. You do not furnish your TIN to the requester,
2. You do not certify your TIN when required (see the instructions for Part II for details),
3. The IRS tells the requester that you furnished an incorrect TIN,
4. The IRS tells you that you are subject to backup withholding because you did not report all your interest and dividends on your tax return (for reportable interest and dividends only), or
5. You do not certify to the requester that you are not subject to backup withholding under 4 above (for reportable interest and dividend accounts opened after 1983 only).

Certain payees and payments are exempt from backup withholding. See *Exempt payee code*, later, and the separate instructions for the Requester of Form W-9 for more information.

Also see *Special rules for partnerships*, earlier.

## What is FATCA Reporting?

The Foreign Account Tax Compliance Act (FATCA) requires a participating foreign financial institution to report all United States account holders that are specified United States persons. Certain payees are exempt from FATCA reporting. See *Exemption from FATCA reporting code*, later, and the instructions for the Requester of Form W-9 for more information.

## Updating Your Information

You must provide updated information to any person to whom you claimed to be an exempt payee if you are no longer an exempt payee and anticipate receiving reportable payments in the future from this person. For example, you may need to provide updated information if you are a C corporation that elects to be an S corporation, or if you no longer are tax exempt. In addition, you must furnish a new Form W-9 if the name or TIN changes for the account; for example, if the grantor of a grantor trust dies.

## Penalties

**Failure to furnish TIN.** If you fail to furnish your correct TIN to a requester, you are subject to a penalty of \$50 for each such failure unless your failure is due to reasonable cause and not to willful neglect.

**Civil penalty for false information with respect to withholding.** If you make a false statement with no reasonable basis that results in no backup withholding, you are subject to a \$500 penalty.

**Criminal penalty for falsifying information.** Willfully falsifying certifications or affirmations may subject you to criminal penalties including fines and/or imprisonment.

**Misuse of TINs.** If the requester discloses or uses TINs in violation of federal law, the requester may be subject to civil and criminal penalties.

## Specific Instructions

### Line 1

You must enter one of the following on this line; do not leave this line blank. The name should match the name on your tax return.

If this Form W-9 is for a joint account (other than an account maintained by a foreign financial institution (FFI)), list first, and then circle, the name of the person or entity whose number you entered in Part I of Form W-9. If you are providing Form W-9 to an FFI to document a joint account, each holder of the account that is a U.S. person must provide a Form W-9.

**a. Individual.** Generally, enter the name shown on your tax return. If you have changed your last name without informing the Social Security Administration (SSA) of the name change, enter your first name, the last name as shown on your social security card, and your new last name.

**Note: ITIN applicant:** Enter your individual name as it was entered on your Form W-7 application, line 1a. This should also be the same as the name you entered on the Form 1040/1040A/1040EZ you filed with your application.

**b. Sole proprietor or single-member LLC.** Enter your individual name as shown on your 1040/1040A/1040EZ on line 1. You may enter your business, trade, or "doing business as" (DBA) name on line 2.

**c. Partnership, LLC that is not a single-member LLC, C corporation, or S corporation.** Enter the entity's name as shown on the entity's tax return on line 1 and any business, trade, or DBA name on line 2.

**d. Other entities.** Enter your name as shown on required U.S. federal tax documents on line 1. This name should match the name shown on the charter or other legal document creating the entity. You may enter any business, trade, or DBA name on line 2.

**e. Disregarded entity.** For U.S. federal tax purposes, an entity that is disregarded as an entity separate from its owner is treated as a "disregarded entity." See Regulations section 301.7701-2(c)(2)(iii). Enter the owner's name on line 1. The name of the entity entered on line 1 should never be a disregarded entity. The name on line 1 should be the name shown on the income tax return on which the income should be reported. For example, if a foreign LLC that is treated as a disregarded entity for U.S. federal tax purposes has a single owner that is a U.S. person, the U.S. owner's name is required to be provided on line 1. If the direct owner of the entity is also a disregarded entity, enter the first owner that is not disregarded for federal tax purposes. Enter the disregarded entity's name on line 2, "Business name/disregarded entity name." If the owner of the disregarded entity is a foreign person, the owner must complete an appropriate Form W-8 instead of a Form W-9. This is the case even if the foreign person has a U.S. TIN.

### Line 2

If you have a business name, trade name, DBA name, or disregarded entity name, you may enter it on line 2.

### Line 3

Check the appropriate box on line 3 for the U.S. federal tax classification of the person whose name is entered on line 1. Check only one box on line 3.

IF the entity/person on line 1 is a(n) . . .	THEN check the box for . . .
• Corporation	Corporation
• Individual • Sole proprietorship, or • Single-member limited liability company (LLC) owned by an individual and disregarded for U.S. federal tax purposes.	Individual/sole proprietor or single-member LLC
• LLC treated as a partnership for U.S. federal tax purposes, • LLC that has filed Form 8832 or 2553 to be taxed as a corporation, or • LLC that is disregarded as an entity separate from its owner but the owner is another LLC that is not disregarded for U.S. federal tax purposes.	Limited liability company and enter the appropriate tax classification, (P= Partnership; C= C corporation; or S= S corporation)
• Partnership	Partnership
• Trust/estate	Trust/estate

### Line 4, Exemptions

If you are exempt from backup withholding and/or FATCA reporting, enter in the appropriate space on line 4 any code(s) that may apply to you.

**Exempt payee code.**

- Generally, individuals (including sole proprietors) are not exempt from backup withholding.
- Except as provided below, corporations are exempt from backup withholding for certain payments, including interest and dividends.
- Corporations are not exempt from backup withholding for payments made in settlement of payment card or third party network transactions.
- Corporations are not exempt from backup withholding with respect to attorneys' fees or gross proceeds paid to attorneys, and corporations that provide medical or health care services are not exempt with respect to payments reportable on Form 1099-MISC.

The following codes identify payees that are exempt from backup withholding. Enter the appropriate code in the space in line 4.

- 1—An organization exempt from tax under section 501(a), any IRA, or a custodial account under section 403(b)(7) if the account satisfies the requirements of section 401(f)(2)
- 2—The United States or any of its agencies or instrumentalities
- 3—A state, the District of Columbia, a U.S. commonwealth or possession, or any of their political subdivisions or instrumentalities
- 4—A foreign government or any of its political subdivisions, agencies, or instrumentalities
- 5—A corporation
- 6—A dealer in securities or commodities required to register in the United States, the District of Columbia, or a U.S. commonwealth or possession
- 7—A futures commission merchant registered with the Commodity Futures Trading Commission
- 8—A real estate investment trust
- 9—An entity registered at all times during the tax year under the Investment Company Act of 1940
- 10—A common trust fund operated by a bank under section 584(a)
- 11—A financial institution
- 12—A middleman known in the investment community as a nominee or custodian
- 13—A trust exempt from tax under section 664 or described in section 4947

The following chart shows types of payments that may be exempt from backup withholding. The chart applies to the exempt payees listed above, 1 through 13.

IF the payment is for . . .	THEN the payment is exempt for . . .
Interest and dividend payments	All exempt payees except for 7
Broker transactions	Exempt payees 1 through 4 and 6 through 11 and all C corporations. S corporations must not enter an exempt payee code because they are exempt only for sales of noncovered securities acquired prior to 2012.
Barter exchange transactions and patronage dividends	Exempt payees 1 through 4
Payments over \$600 required to be reported and direct sales over \$5,000 <sup>1</sup>	Generally, exempt payees 1 through 5 <sup>2</sup>
Payments made in settlement of payment card or third party network transactions	Exempt payees 1 through 4

<sup>1</sup> See Form 1099-MISC, Miscellaneous Income, and Its Instructions.

<sup>2</sup> However, the following payments made to a corporation and reportable on Form 1099-MISC are not exempt from backup withholding: medical and health care payments, attorneys' fees, gross proceeds paid to an attorney reportable under section 6045(f), and payments for services paid by a federal executive agency.

**Exemption from FATCA reporting code.** The following codes identify payees that are exempt from reporting under FATCA. These codes apply to persons submitting this form for accounts maintained outside of the United States by certain foreign financial institutions. Therefore, if you are only submitting this form for an account you hold in the United States, you may leave this field blank. Consult with the person requesting this form if you are uncertain if the financial institution is subject to these requirements. A requester may indicate that a code is not required by providing you with a Form W-9 with "Not Applicable" (or any similar indication) written or printed on the line for a FATCA exemption code.

A—An organization exempt from tax under section 501(a) or any individual retirement plan as defined in section 7701(a)(37)

B—The United States or any of its agencies or instrumentalities

C—A state, the District of Columbia, a U.S. commonwealth or possession, or any of their political subdivisions or instrumentalities

D—A corporation the stock of which is regularly traded on one or more established securities markets, as described in Regulations section 1.1472-1(c)(1)(i)

E—A corporation that is a member of the same expanded affiliated group as a corporation described in Regulations section 1.1472-1(c)(1)(i)

F—A dealer in securities, commodities, or derivative financial instruments (including notional principal contracts, futures, forwards, and options) that is registered as such under the laws of the United States or any state

G—A real estate investment trust

H—A regulated investment company as defined in section 851 or an entity registered at all times during the tax year under the Investment Company Act of 1940

I—A common trust fund as defined in section 584(a)

J—A bank as defined in section 581

K—A broker

L—A trust exempt from tax under section 664 or described in section 4947(a)(1)

M—A tax exempt trust under a section 403(b) plan or section 457(g) plan

**Note:** You may wish to consult with the financial institution requesting this form to determine whether the FATCA code and/or exempt payee code should be completed.

### Line 5

Enter your address (number, street, and apartment or suite number). This is where the requester of this Form W-9 will mail your information returns. If this address differs from the one the requester already has on file, write NEW at the top. If a new address is provided, there is still a chance the old address will be used until the payor changes your address in their records.

### Line 6

Enter your city, state, and ZIP code.

## Part I. Taxpayer Identification Number (TIN)

Enter your TIN in the appropriate box. If you are a resident alien and you do not have and are not eligible to get an SSN, your TIN is your IRS individual taxpayer identification number (ITIN). Enter it in the social security number box. If you do not have an ITIN, see *How to get a TIN* below.

If you are a sole proprietor and you have an EIN, you may enter either your SSN or EIN.

If you are a single-member LLC that is disregarded as an entity separate from its owner, enter the owner's SSN (or EIN, if the owner has one). Do not enter the disregarded entity's EIN. If the LLC is classified as a corporation or partnership, enter the entity's EIN.

**Note:** See *What Name and Number To Give the Requester*, later, for further clarification of name and TIN combinations.

**How to get a TIN.** If you do not have a TIN, apply for one immediately. To apply for an SSN, get Form SS-5, Application for a Social Security Card, from your local SSA office or get this form online at [www.SSA.gov](http://www.SSA.gov). You may also get this form by calling 1-800-772-1213. Use Form W-7, Application for IRS Individual Taxpayer Identification Number, to apply for an ITIN, or Form SS-4, Application for Employer Identification Number, to apply for an EIN. You can apply for an EIN online by accessing the IRS website at [www.irs.gov/Businesses](http://www.irs.gov/Businesses) and clicking on Employer Identification Number (EIN) under Starting a Business. Go to [www.irs.gov/Forms](http://www.irs.gov/Forms) to view, download, or print Form W-7 and/or Form SS-4. Or, you can go to [www.irs.gov/OrderForms](http://www.irs.gov/OrderForms) to place an order and have Form W-7 and/or SS-4 mailed to you within 10 business days.

If you are asked to complete Form W-9 but do not have a TIN, apply for a TIN and write "Applied For" in the space for the TIN, sign and date the form, and give it to the requester. For interest and dividend payments, and certain payments made with respect to readily tradable instruments, generally you will have 60 days to get a TIN and give it to the requester before you are subject to backup withholding on payments. The 60-day rule does not apply to other types of payments. You will be subject to backup withholding on all such payments until you provide your TIN to the requester.

**Note:** Entering "Applied For" means that you have already applied for a TIN or that you intend to apply for one soon.

**Caution:** A disregarded U.S. entity that has a foreign owner must use the appropriate Form W-8.

## Part II. Certification

To establish to the withholding agent that you are a U.S. person, or resident alien, sign Form W-9. You may be requested to sign by the withholding agent even if item 1, 4, or 5 below indicates otherwise.

For a joint account, only the person whose TIN is shown in Part I should sign (when required). In the case of a disregarded entity, the person identified on line 1 must sign. Exempt payees, see *Exempt payee code*, earlier.

**Signature requirements.** Complete the certification as indicated in items 1 through 5 below.

1. Interest, dividend, and barter exchange accounts opened before 1984 and broker accounts considered active during 1983. You must give your correct TIN, but you do not have to sign the certification.
2. Interest, dividend, broker, and barter exchange accounts opened after 1983 and broker accounts considered inactive during 1983. You must sign the certification or backup withholding will apply. If you are subject to backup withholding and you are merely providing your correct TIN to the requester, you must cross out item 2 in the certification before signing the form.
3. Real estate transactions. You must sign the certification. You may cross out item 2 of the certification.
4. Other payments. You must give your correct TIN, but you do not have to sign the certification unless you have been notified that you have previously given an incorrect TIN. "Other payments" include payments made in the course of the requester's trade or business for rents, royalties, goods (other than bills for merchandise), medical and health care services (including payments to corporations), payments to a nonemployee for services, payments made in settlement of payment card and third party network transactions, payments to certain fishing boat crew members and fishermen, and gross proceeds paid to attorneys (including payments to corporations).
5. Mortgage interest paid by you, acquisition or abandonment of secured property, cancellation of debt, qualified tuition program payments (under section 529), ABLÉ accounts (under section 529A), IRA, Coverdell ESA, Archer MSA or HSA contributions or distributions, and pension distributions. You must give your correct TIN, but you do not have to sign the certification.

**What Name and Number To Give the Requester**

For this type of account:	Give name and SSN of:
1. Individual	The individual
2. Two or more individuals (joint account) other than an account maintained by an FFI	The actual owner of the account or, if combined funds, the first individual on the account <sup>1</sup>
3. Two or more U.S. persons (joint account maintained by an FFI)	Each holder of the account
4. Custodial account of a minor (Uniform Gift to Minors Act)	The minor <sup>2</sup>
5. a. The usual revocable savings trust (grantor is also trustee) b. So-called trust account that is not a legal or valid trust under state law	The grantor-trustee <sup>1</sup> The actual owner <sup>1</sup>
6. Sole proprietorship or disregarded entity owned by an individual	The owner <sup>3</sup>
7. Grantor trust filing under Optional Form 1099 Filing Method 1 (see Regulations section 1.671-4(b)(2)(i)(A))	The grantor <sup>4</sup>
For this type of account:	Give name and EIN of:
8. Disregarded entity not owned by an individual	The owner
9. A valid trust, estate, or pension trust	Legal entity <sup>4</sup>
10. Corporation or LLC electing corporate status on Form 8832 or Form 2553	The corporation
11. Association, club, religious, charitable, educational, or other tax-exempt organization	The organization
12. Partnership or multi-member LLC	The partnership
13. A broker or registered nominee	The broker or nominee

For this type of account:	Give name and EIN of:
14. Account with the Department of Agriculture in the name of a public entity (such as a state or local government, school district, or prison) that receives agricultural program payments	The public entity
15. Grantor trust filing under the Form 1041 Filing Method or the Optional Form 1099 Filing Method 2 (see Regulations section 1.671-4(b)(2)(i)(B))	The trust

- <sup>1</sup> List first and circle the name of the person whose number you furnish. If only one person on a joint account has an SSN, that person's number must be furnished.
  - <sup>2</sup> Circle the minor's name and furnish the minor's SSN.
  - <sup>3</sup> You must show your individual name and you may also enter your business or DBA name on the "Business name/disregarded entity" name line. You may use either your SSN or EIN (if you have one), but the IRS encourages you to use your SSN.
  - <sup>4</sup> List first and circle the name of the trust, estate, or pension trust. (Do not furnish the TIN of the personal representative or trustee unless the legal entity itself is not designated in the account title.) Also see *Special rules for partnerships*, earlier.
- \*Note: The grantor also must provide a Form W-9 to trustee of trust.  
 Note: If no name is circled when more than one name is listed, the number will be considered to be that of the first name listed.

**Secure Your Tax Records From Identity Theft**

Identity theft occurs when someone uses your personal information such as your name, SSN, or other identifying information, without your permission, to commit fraud or other crimes. An identity thief may use your SSN to get a job or may file a tax return using your SSN to receive a refund.

To reduce your risk:

- Protect your SSN,
  - Ensure your employer is protecting your SSN, and
  - Be careful when choosing a tax preparer.
- If your tax records are affected by identity theft and you receive a notice from the IRS, respond right away to the name and phone number printed on the IRS notice or letter.
- If your tax records are not currently affected by identity theft but you think you are at risk due to a lost or stolen purse or wallet, questionable credit card activity or credit report, contact the IRS Identity Theft Hotline at 1-800-908-4490 or submit Form 14039.
- For more information, see Pub. 5027, Identity Theft Information for Taxpayers.

Victims of identity theft who are experiencing economic harm or a systemic problem, or are seeking help in resolving tax problems that have not been resolved through normal channels, may be eligible for Taxpayer Advocate Service (TAS) assistance. You can reach TAS by calling the TAS toll-free case intake line at 1-877-777-4778 or TTY/TDD 1-800-829-4059.

**Protect yourself from suspicious emails or phishing schemes.** Phishing is the creation and use of email and websites designed to mimic legitimate business emails and websites. The most common act is sending an email to a user falsely claiming to be an established legitimate enterprise in an attempt to scam the user into surrendering private information that will be used for identity theft.

The IRS does not initiate contacts with taxpayers via emails. Also, the IRS does not request personal detailed information through email or ask taxpayers for the PIN numbers, passwords, or similar secret access information for their credit card, bank, or other financial accounts.

If you receive an unsolicited email claiming to be from the IRS, forward this message to [phishing@irs.gov](mailto:phishing@irs.gov). You may also report misuse of the IRS name, logo, or other IRS property to the Treasury Inspector General for Tax Administration (TIGTA) at 1-800-368-4484. You can forward suspicious emails to the Federal Trade Commission at [spam@uce.gov](mailto:spam@uce.gov) or report them at [www.ftc.gov/complaint](http://www.ftc.gov/complaint). You can contact the FTC at [www.ftc.gov/idtheft](http://www.ftc.gov/idtheft) or 877-IDTHEFT (877-438-4338). If you have been the victim of identity theft, see [www.IdentityTheft.gov](http://www.IdentityTheft.gov) and Pub. 5027.

Visit [www.irs.gov/IdentityTheft](http://www.irs.gov/IdentityTheft) to learn more about identity theft and how to reduce your risk.

## Privacy Act Notice

Section 6109 of the Internal Revenue Code requires you to provide your correct TIN to persons (including federal agencies) who are required to file information returns with the IRS to report interest, dividends, or certain other income paid to you; mortgage interest you paid; the acquisition or abandonment of secured property; the cancellation of debt; or contributions you made to an IRA, Archer MSA, or HSA. The person collecting this form uses the information on the form to file information returns with the IRS, reporting the above information. Routine uses of this information include giving it to the Department of Justice for civil and criminal litigation and to cities, states, the District of Columbia, and U.S. commonwealths and possessions for use in administering their laws. The information also may be disclosed to other countries under a treaty, to federal and state agencies to enforce civil and criminal laws, or to federal law enforcement and intelligence agencies to combat terrorism. You must provide your TIN whether or not you are required to file a tax return. Under section 3406, payers must generally withhold a percentage of taxable interest, dividend, and certain other payments to a payee who does not give a TIN to the payer. Certain penalties may also apply for providing false or fraudulent information.

Exhibit "F"

Certification Regarding

Debarment

**Certification  
Regarding Debarment, Suspension Ineligibility**

As is required by the Federal Regulations Implementing Executive Order 12549, Debarment and Suspension, 45 CFR Part 76, Government-wide Debarment and Suspension, in the applicant certifies, to the best of his or her knowledge and belief, that both it and its principals:

- a. Are not presently debarred, suspended, proposed for debarment, declared ineligible, or voluntarily excluded from participation in this transaction by any federal department or agency;
- b. Have not within a three-year period preceding this bid/proposal and/or application been convicted of or had a civil judgment rendered against them for commission of fraud or a criminal offense in connection with obtaining, attempting to obtain, or performing a public (federal, state or local) transaction or contract under a public transaction, violation of federal or state antitrust statutes or commission of embezzlement, theft, theory, forgery, bribery, falsification or destruction of records, making false statements, or receiving stolen property;
- c. Are not presently indicted for or otherwise criminally or civilly charged by a government entity with commission of any of the offenses enumerated herein; and
- d. Have not within a three-year period preceding this bid/proposal and/or application had one or more public transactions terminated of cause or default.

Signature: \_\_\_\_\_

Print Name: \_\_\_\_\_

Title: \_\_\_\_\_

Telephone Number: \_\_\_\_\_

Date: \_\_\_\_\_

If the proposer is unable to certify to all of the statements in this Certification, such proposer should attach an explanation to this proposal.

Exhibit "G"

Title VI Appendices

"A" thru "E"

## APPENDIX A

During the performance of this contract, the contractor, for itself, its assignees, and successors in interest (hereinafter referred to as the "contractor") agrees as follows:

1. **Compliance with Regulations:** The contractor (hereinafter includes consultants) will comply with the Acts and the Regulations relative to Nondiscrimination in Federally-assisted programs of the U.S. Department of Transportation, the Federal Highway Administration, as they may be amended from time to time, which are herein incorporated by reference and made a part of this contract.
2. **Nondiscrimination:** The contractor, with regard to the work performed by it during the contract, will not discriminate on the grounds of race, color, or national origin in the selection and retention of subcontractors, including procurements of materials and leases of equipment. The contractor will not participate directly or indirectly in the discrimination prohibited by the Acts and the Regulations, including employment practices when the contract covers any activity, project, or program set forth in Appendix B of 49 CFR Part 21.
3. **Solicitations for Subcontracts, Including Procurements of Materials and Equipment:** In all solicitations, either by competitive bidding, or negotiation made by the contractor for work to be performed under a subcontract, including procurements of materials, or leases of equipment, each potential subcontractor or supplier will be notified by the contractor of the contractor's obligations under this contract and the Acts and the Regulations relative to Nondiscrimination on the grounds of race, color, or national origin.
4. **Information and Reports:** The contractor will provide all information and reports required by the Acts, the Regulations, and directives issued pursuant thereto and will permit access to its books, records, accounts, other sources of information, and its facilities as may be determined by the Recipient or the Federal Highway Administration to be pertinent to ascertain compliance with such Acts, Regulations, and instructions. Where any information required of a contractor is in the exclusive possession of another who fails or refuses to furnish the information, the contractor will so certify to the Recipient or the Federal Highway Administration, as appropriate, and will set forth what efforts it has made to obtain the information.
5. **Sanctions for Noncompliance:** In the event of a contractor's noncompliance with the Nondiscrimination provisions of this contract, the Recipient will impose such contract sanctions as it or the Federal Highway Administration may determine to be appropriate, including, but not limited to:
  - a. withholding payments to the contractor under the contract until the contractor complies; and/or
  - b. cancelling, terminating, or suspending contract, in whole or in part.
6. **Incorporation of Provisions:** The contractor will include the provisions of paragraphs one through six in every subcontract, including procurements of materials and leases of equipment, unless exempt by the Acts, the Regulations and directives issued pursuant thereto. The contractor will take action with respect to any subcontract or procurement as the Recipient or the Federal Highway Administration may direct as a means of enforcing such provisions including sanctions for noncompliance. Provided, that if the contractor becomes involved in, or is threatened with litigation by a subcontractor, or supplier because of such direction, the contractor may request the Recipient to enter into any litigation to protect the interests of the Recipient. In addition, the contractor may request the United States to enter into the litigation to protect the interests of the United States.

## APPENDIX B

### CLAUSES FOR DEEDS TRANSFERRING UNITED STATES PROPERTY

The following clauses will be included in deeds effecting or recording the transfer of real property, structures, or improvements thereon, or granting interest therein from the United States pursuant to the provisions of Assurance 4:

NOW, THEREFORE, the U.S. Department of Transportation as authorized by law and upon the condition that the **COUNTY OF HIDALGO** will accept title to the lands and maintain the project constructed thereon in accordance with all applicable federal statutes, the Regulations for the Administration of all Department of Transportation programs, and the policies and procedures prescribed by the Federal Highway Administration of the U.S. Department of Transportation in accordance and in compliance with all requirements imposed by Title 49, Code of Federal Regulations, U.S. Department of Transportation, Subtitle A, Office of the Secretary, Part 21, Nondiscrimination in Federally-assisted programs of the U.S. Department of Transportation pertaining to and effectuating the provisions of Title VI of the Civil Rights Act of 1964 (78 Stat. 252; 42 U.S.C. § 2000d to 2000d-4), does hereby remise, release, quitclaim and convey unto the **COUNTY OF HIDALGO** all the right, title and interest of the U.S. Department of Transportation in and to said lands described in Exhibit 1 attached hereto and made a part hereof.

#### (HABENDUM CLAUSE)

TO HAVE AND TO HOLD said lands and interests therein unto **COUNTY OF HIDALGO** and its successors forever, subject, however, to the covenants, conditions, restrictions and reservations herein contained as follows, which will remain in effect for the period during which the real property or structures are used for a purpose for which Federal financial assistance is extended or for another purpose involving the provision of similar services or benefits and will be binding on the **COUNTY OF HIDALGO**, its successors and assigns.

The **COUNTY OF HIDALGO**, in consideration of the conveyance of said lands and interests in lands, does hereby covenant and agree as a covenant running with the land for itself, its successors and assigns, that (1) no person will on the grounds of race, color, or national origin, be excluded from participation in, be denied the benefits of, or be otherwise subjected to discrimination with regard to any facility located wholly or in part on, over, or under such lands hereby conveyed [,] [and]\* (2) that the **COUNTY OF HIDALGO** will use the lands and interests in lands and interests in lands so conveyed, in compliance with all requirements imposed by or pursuant to Title 49, Code of Federal Regulations, U.S. Department of Transportation, Subtitle A, Office of the Secretary, Part 21, Nondiscrimination in Federally-assisted programs of the U.S. Department of Transportation, Effectuation of Title VI of the Civil Rights Act of 1964, and as said Regulations and Acts may be amended[, and(3) that in the event of breach of any of the above-mentioned nondiscrimination conditions, the Department will have a right to enter or re-enter said lands and facilities on said land, and that above described land and facilities will thereon revert to and vest in and become the absolute property of the U.S. Department of Transportation and its assigns as such interest existed prior to this instruction].\*

(\*Reverted clause and related language to be used only when it is determined that such a clause is necessary in order to make clear the purpose of Title VI.)

## APPENDIX C

### CLAUSES FOR TRANSFER OF REAL PROPERTY ACQUIRED OR IMPROVED UNDER THE ACTIVITY, FACILITY, OR PROGRAM

The following clauses will be included in deeds, licenses, leases, permits, or similar instruments entered into by the **COUNTY OF HIDALGO** pursuant to the provisions of Assurance 7(a):

- A. The (grantee, lessee, permittee, etc. as appropriate) for himself/herself, his/her heirs, personal representatives, successors in interest, and assigns, as a part of the consideration hereof, does hereby covenant and agree [in the case of deeds and leases add "as a covenant running with the land"] that:
  1. In the event facilities are constructed, maintained, or otherwise operated on the property described in this (deed, license, lease, permit, etc.) for a purpose for which a U.S. Department of Transportation activity, facility, or program is extended or for another purpose involving the provision of similar services or benefits, the (grantee, licensee, lessee, permitted, etc.) will maintain and operate such facilities and services in compliance with all requirements imposed by the Acts and Regulations (as may be amended) such that no person on the grounds of race, color, or national origin, will be excluded from participation in, denied the benefits of, or be otherwise subjected to discrimination in the use of said facilities.
- B. With respect to licenses, leases, permits, etc., in the event of breach of any of the above Nondiscrimination covenants, **COUNTY OF HIDALGO** will have the right to terminate the (lease, license, permit, etc.) and to enter, re-enter, and repossess said lands and facilities thereon, and hold the same as if the (lease, license, permit, etc.) had never been made or issued.\*
- C. With respect to a deed, in the event of breach of any of the above Nondiscrimination covenants, the **COUNTY OF HIDALGO** will have the right to enter or re-enter the lands and facilities thereon, and the above described lands and facilities will there upon revert to and vest in and become the absolute property of the **COUNTY OF HIDALGO** and its assigns.\*

(\*Reverted clause and related language to be used only when it is determined that such a clause is necessary in order to make clear the purpose of Title VI.)

## APPENDIX D

### CLAUSES FOR CONSTRUCTION/USE/ACCESS TO REAL PROPERTY ACQUIRED UNDER THE ACTIVITY, FACILITY OR PROGRAM

The following clauses will be included in deeds, licenses, permits, or similar instruments/agreements entered into by **COUNTY OF HIDALGO** pursuant to the provisions of Assurance 7(b):

- A. The (grantee, licensee, permittee, etc., as appropriate) for himself/herself, his/her heirs, personal representatives, successors in interest, and assigns, as a part of the consideration hereof, does hereby covenant and agree (in the case of deeds and leases add, "as a covenant running with the land") that (1) no person on the ground of race, color, or national origin, will be excluded from participation in, denied the benefits of, or be otherwise subjected to discrimination in the use of said facilities, (2) that in the construction of any improvements on, over, or under such land, and the furnishing of services thereon, no person on the ground of race, color, or national origin, will be excluded from participation in, denied the benefits of, or otherwise be subjected to discrimination, (3) that the (grantee, licensee, lessee, permittee, etc.) will use the premises in compliance with all other requirements imposed by or pursuant to the Acts and Regulations, as amended, set forth in this Assurance.
- B. With respect to (licenses, leases, permits, etc.), in the event of breach of any of the above Nondiscrimination covenants, **COUNTY OF HIDALGO** will have the right to terminate the (license, permit, etc., as appropriate) and to enter or re-enter and repossess said land and the facilities thereon, and hold the same as if said (license, permit, etc., as appropriate) had never been made or issued.\*
- C. With respect to deeds, in the event of breach of any of the above Nondiscrimination covenants, **COUNTY OF HIDALGO** will there upon revert to and vest in and become the absolute property of **COUNTY OF HIDALGO** and its assigns.\*

(\*Reverted clause and related language to be used only when it is determined that such a clause is necessary in order to make clear the purpose of Title VI.)

## APPENDIX E

During the performance of this contract, the contractor, for itself, its assignees, and successors in interest (hereinafter referred to as the "contractor") agrees to comply with the following nondiscrimination statutes and authorities; including but not limited to:

### Pertinent Nondiscrimination Authorities:

- Title VI of the Civil Rights Act of 1964 (42 U.S.C. § 2000d et seq., 78 stat. 252), (prohibits discrimination on the basis of race, color, national origin); and 49CFR Part 21.
- The Uniform Relocation Assistance and Real Property Acquisition Policies Act of 1970, (42U.S.C. § 4601), (prohibits unfair treatment of persons displaced or whose property has been acquired because of Federal or Federal-aid programs and projects);
- Federal-Aid Highway Act of 1973, (23U.S.C. § 324et seq.), (prohibits discrimination on the basis of sex);
- Section 504 of the Rehabilitation Act of 1973, (29U.S.C. § 794 et seq.), as amended, (prohibits discrimination on the basis of disability); and 49CFR Part 27;
- The Age Discrimination Act of 1975, as amended,(42U.S.C. § 6101 et seq.), (prohibits discrimination on the basis of age);
- Airport and Airway Improvement Act of 1982, (49U.S.C. § 4 71, Section 4 7123),as amended, (prohibits discrimination based on race, creed, color, national origin, or sex);
- The Civil Rights Restoration Act of 1987,(PL 100-209), (Broadened the scope, coverage and applicability of Title VI of the Civil Rights Act of 1964, The Age Discrimination Act of 1975 and Section 504 of the Rehabilitation Act of 1973, by expanding the definition of the terms "programs or activities" to include all of the programs or activities of the Federal-aid recipients, sub recipients and contractors, whether such programs or activities are Federally funded or not);
- Titles II and III of the Americans with Disabilities Act, which prohibit discrimination on the basis of disability in the operation of public entities, public and private transportation systems, places of public accommodation, and certain testing entities (42 U.S.C. §§ 12131-12189)as implemented by Department of Transportation regulations at 49C.F.R. parts 37 and 38;
- The Federal Aviation Administration's Nondiscrimination statute (49U.S.C. § 47123) (prohibits discrimination on the basis of race, color, national origin, and sex);
- Executive Order 12898, Federal Actions to Address Environmental Justice in Minority Populations and Low-Income Populations, which ensures discrimination against minority populations by discouraging programs, policies, and activities with disproportionately high and adverse human health or environmental effects on minority and low-income populations;
- Executive Order 13166, Improving Access to Services for Persons with Limited English Proficiency, and resulting agency guidance, national origin discrimination includes discrimination because of limited English proficiency (LEP). To ensure compliance with Title VI, you must take reasonable steps to ensure that LEP persons have meaningful access to your programs (70 Fed. Reg. at 74087 to 74100);
- Title IX of the Education Amendments of 1972, as amended, which prohibits you from discriminating because of sex in education programs or activities (20 U .S.C. 1681 et seq).

# Exhibit “H”

## (If Applicable)

2 C.F.R. § 200.326 & 2 C.F.R. Part 200,  
Appendix II

Required Contract Clauses for Non-Federal  
Entity Contracts Under Federal Awards

&

Required Contract Clauses for Non-Federal  
Entity Contracts Under Federal Awards with  
the Federal Emergency Management Agency  
(FEMA)

## 2 C.F.R. § 200.326 & 2 C.F.R. Part 200, Appendix II, Required Contract Clauses for Non-Federal Entity Contracts Under Federal Awards

The United States Office of Management and Budget (OMB) issued in 2 C.F.R. 200: *Uniform Administrative Requirements, Cost Principles and Audit Requirements for Federal Awards* (Uniform Guidance). Subpart D: Post Federal Award Requirements: 2 CFR §§200.317-200.326 of the Uniform Guidance contain provisions applicable to procurements made with federal grant funding.

As a non-Federal entity, the County of Hidalgo's ("County") contracts must contain the applicable contract clauses described in Appendix II to the Uniform Guidance (Contract Provisions for non-Federal Entity Contracts Under Federal Awards), which are set forth below. 2 C.F.R. §200.326. If applicable, the following clauses shall supersede any existing, similar clauses stated within the bid document, contract, and/or Terms and Conditions. *The term "Contractor" used herein refers to the proposer, bidder or other entity/individual responding to the applicable procurement packet.*

*If applicable, the regulations in 2 CFR, Part 200 and Appendix II to the Uniform Guidance, as it may be amended from time to time, and the contract clauses below, are incorporated by reference as part of this procurement packet and any resulting agreement.*

To procure goods and services using funds under a federal grant or contract, specific federal laws, regulations, and requirements may apply in addition to those under state law. The following provisions are required and apply when federal funds are expended by the County of Hidalgo for any contract resulting from this procurement process.

### 1. Remedies.

- a. Applicability. This requirement applies to all Federal grant and cooperative agreement programs.
- b. Standard. Contracts for more than the simplified acquisition threshold currently set at \$150,000, which is the inflation adjusted amount determined by the Civilian Agency Acquisition Council and the Defense Acquisition Regulations Council (Councils) as authorized by 41 U.S.C. 1908, must address administrative, contractual, or legal remedies in instances where contractors violate or breach contract terms, and provide for such sanctions and penalties as appropriate. See 2 C.F.R. Part 200, Appendix II, ¶ A.
- c. Statement. Pursuant to Federal Rule (A) above, when federal funds are expended by the County, the County reserves all rights and privileges under the applicable laws and regulations with respect to this procurement in the event of breach of contract by either party. Contractor shall comply with all applicable Federal, State of Texas, and local laws, rules, and regulations and shall obtain all applicable licenses and permits for the conduct of its business and the performance of the services, and any provision of equipment and material ("Applicable Law"). All transactions related to any of the Contract Documents shall be governed by the laws of the State of Texas, and trial of any action brought in connection with the bid or the Contract Documents shall be held exclusively in a state court in the County of Hidalgo, Texas.

2. Termination for Cause and Convenience.

- a. Applicability. This requirement applies to all Federal grant and cooperative agreement programs.
- b. Standard. All contracts in excess of \$10,000 shall address termination for cause and for convenience by the non-Federal entity including the manner by which it will be effected and the basis for settlement as follows. See 2 C.F.R. Part 200, Appendix II, ¶ B.
- c. Statement. Termination. County may terminate this Agreement for any reason upon ten (10) days written notice to the other party. County may terminate this Agreement immediately upon written notice if Contractor breaches this Agreement. In the event of any termination, Contractor shall promptly deliver to the County any and all Work Materials prepared for the County prior to the effective date of such termination, all of which shall become County's sole property. After receipt of the Work Materials, County will pay Contractor for the services which the County determines were satisfactorily performed as of the effective date of the termination.

*Excuses for Non-Performance.* Either party shall be absolved from its obligations under this contract when and to the extent that performance is delayed or prevented (and in the County of Hidalgo's case when and to the extent that its need for the articles, materials or work to be supplied hereunder is reduced or eliminated) by reason of acts of God, fire explosion, war riots, strikes, labor disputes, or governmental laws, orders or regulations.

*Default.* If Contractor or Subcontractor shall breach any provision hereof or shall become insolvent, enter voluntary or involuntary bankruptcy or receivership proceedings or make an assignment to the benefit of creditors, County of Hidalgo shall have the right (without limiting any other rights or remedies which it may have hereunder or by operation of law) to terminate this contract by written notice to Contractor whereupon County shall be relieved of all further obligation hereunder except the obligation to pay the reasonable value of Contractor's prior performance (at not exceeding the contract rate), and Contractor shall be liable to County for all costs incurred by County in completing or procuring the completion of performance in excess of the contract price herein specified. The County's right to require strict performance of any obligation hereunder shall not be affected by any previous waiver, forbearance of course of dealing. Time is of the essence thereof.

3. Equal Employment Opportunity.

- a. Applicability: This requirement applies to all Federal grant and cooperative agreement programs.
- b. Standard. Except as otherwise provided under 41 C.F.R. Part 60, all contracts that meet the definition of "federally assisted construction contract" in 41 C.F.R. § 60-1.3 must include the equal opportunity clause provided under 41 C.F.R. § 60- 1.4(b), in accordance with Executive Order 11246, *Equal Employment Opportunity* (30 Fed. Reg. 12319, 12935, 3 C.F.R. Part, 1964-1965 Comp., p. 339), as amended by Executive Order 11375, *Amending Executive Order 11246 Relating to Equal Employment Opportunity*, and implementing regulations at 41 C.F.R. Part 60 (Office of Federal Contract Compliance Programs, Equal Employment Opportunity, Department of Labor). See 2 C.F.R. Part 200, Appendix II, ¶ C.

c. Key Definitions:

- (1) *Federally Assisted Construction Contract.* The regulation at 41 C.F.R. § 60-1.3 defines a "federally assisted construction contract" as any agreement or modification thereof between any applicant and a person for construction work which is paid for in whole or in part with funds obtained from the Government or borrowed on the credit of the Government pursuant to any Federal program involving a grant, contract, loan, insurance, or guarantee, or undertaken pursuant to any Federal program involving such grant, contract, loan, insurance, or guarantee, or any application or modification thereof approved by the Government for a grant, contract, loan, insurance, or guarantee under which the applicant itself participates in the construction work.
- (2) *Construction Work.* The regulation at 41 C.F.R. § 60-1.3 defines "construction work" as the construction, rehabilitation, alteration, conversion, extension, demolition or repair of buildings, highways, or other changes or improvements to real property, including facilities providing utility services. The term also includes the supervision, inspection, and other onsite functions incidental to the actual construction

- d. Statement: Contractor will comply with the Nondiscrimination Civil Rights Act of 1964, as amended and all Federal regulations relative to nondiscrimination in Federally assisted programs. The regulation at 41 C.F.R. Part 60-1.4(b) requires the insertion of the following contract clause:

"During the performance of this contract, the contractor agrees as follows:

(1) The contractor will not discriminate against any employee or applicant for employment because of race, color, religion, sex, or national origin. The contractor will take affirmative action to ensure that applicants are employed, and that employees are treated during employment without regard to their race, color, religion, sex, or national origin. Such action shall include, but not be limited to the following: Employment, upgrading, demotion, or transfer; recruitment or recruitment advertising; layoff or termination; rates of pay or other forms of compensation; and selection for training, including apprenticeship. The contractor agrees to post in conspicuous places, available to employees and applicants for employment, notices to be provided setting forth the provisions of this nondiscrimination clause.

(2) The contractor will, in all solicitations or advertisements for employees placed by or on behalf of the contractor, state that all qualified applicants will receive considerations for employment without regard to race, color, religion, sex, or national origin.

(3) The contractor will send to each labor union or representative of workers with which he has a collective bargaining agreement or other contract or understanding, a notice to be provided advising the said labor union or workers' representatives of the contractor's commitments under this section, and shall post copies of the notice in conspicuous places available to employees and applicants for employment.

(4) The contractor will comply with all provisions of Executive Order 11246 of September 24, 1965, and of the rules, regulations, and relevant orders of the Secretary of Labor.

(5) The contractor will furnish all information and reports required by Executive Order 11246 of September 24, 1965, and by rules, regulations, and orders of the Secretary of Labor, or pursuant thereto, and will permit access to his books, records, and accounts by the

administering agency and the Secretary of Labor for purposes of investigation to ascertain compliance with such rules, regulations, and orders.

(6) In the event of the contractor's noncompliance with the nondiscrimination clauses of this contract or with any of the said rules, regulations, or orders, this contract may be canceled, terminated, or suspended in whole or in part and the contractor may be declared ineligible for further Government contracts or federally assisted construction contracts in accordance with procedures authorized in Executive Order 11246 of September 24, 1965, and such other sanctions as may be imposed and remedies invoked as provided in Executive Order 11246 of September 24, 1965, or by rule, regulation, or order of the Secretary of Labor, or as otherwise provided by law.

(7) The contractor will include the portion of the sentence immediately preceding paragraph (1) and the provisions of paragraphs (1) through (7) in every subcontract or purchase order unless exempted by rules, regulations, or orders of the Secretary of Labor issued pursuant to section 204 of Executive Order 11246 of September 24, 1965, so that such provisions will be binding upon each subcontractor or vendor. The contractor will take such action with respect to any subcontract or purchase order as the administering agency may direct as a means of enforcing such provisions, including sanctions for noncompliance: Provided, however, That in the event a contractor becomes involved in, or is threatened with, litigation with a subcontractor or vendor as a result of such direction by the administering agency the contractor may request the United States to enter into such litigation to protect the interests of the United States."

#### 4. Davis Bacon Act and Copeland Anti-Kickback Act.

- a. Applicability of Davis-Bacon Act. The Davis-Bacon Act only applies to the emergency Management Preparedness Grant Program, Homeland Security Grant Program, Nonprofit Security Grant Program, Tribal Homeland Security Grant Program, Port Security Grant Program, and Transit Security Grant Program. **It does not apply to other Federal grant and cooperative agreement programs, including the Public Assistance Program.**
- b. Standard. All prime construction contracts in excess of \$2,000 awarded by non-Federal entities must include a provision for compliance with the Davis-Bacon Act (40 U.S.C. §§ 3141-3144 and 3146-3148) as supplemented by Department of Labor regulations at 29 C.F.R. Part 5 (Labor Standards Provisions Applicable to Contracts Covering Federally Financed and Assisted Construction)). See 2 C.F.R. Part 200, Appendix II, ¶ D.

In accordance with the statute, contractors must be required to pay wages to laborers and mechanics at a rate not less than the prevailing wages specified in a wage determination made by the Secretary of Labor. In addition, contractors must be required to pay wages not less than once a week.

The non-Federal entity must place a copy of the current prevailing wage determination issued by the Department of Labor in each solicitation. The decision to award a contract or subcontract must be conditioned upon the acceptance of the wage determination. The non-Federal entity must report all suspected or reported violations to the Federal awarding City.

In contracts subject to the Davis-Bacon Act, the contracts must also include a provision for compliance with the Copeland "Anti-Kickback" Act (40 U.S.C. § 3145), as supplemented by

Department of Labor regulations at 29 C.F.R. Part 3 (Contractors and Subcontractors on Public Building or Public Work Financed in Whole or in Part by Loans or Grants from the United States). The Copeland Anti-Kickback Act provides that each contractor or subrecipient must be prohibited from inducing, by any means, any person employed in the construction, completion, or repair of public work, to give up any part of the compensation to which he or she is otherwise entitled. The non-Federal entity must report all suspected or reported violations to FEMA or applicable Federal entity.

- c. **Statement.** The regulation at 29 C.F.R. § 5.5(a) does provide the required contract clause that applies to compliance with both the Davis-Bacon and Copeland Acts. However, as discussed in the previous subsection, the Davis-Bacon Act does not apply to Public Assistance recipients and subrecipients. In situations where the Davis-Bacon Act does not apply, neither does the Copeland "Anti-Kickback Act." However, for purposes of grant programs where both clauses do apply, FEMA or applicable Federal entity requires the following contract clause:

"Compliance with the Copeland "Anti-Kickback" Act.

(1) *Contractor.* The contractor shall comply with 18 U.S.C. § 874, 40 U.S.C. § 3145, and the requirements of 29 C.F.R. pt. 3 as may be applicable, which are incorporated by reference into this contract.

(2) *Subcontracts.* The contractor or subcontractor shall insert in any subcontracts the clause above and such other clauses as Federal requirements may by appropriate instructions require, and also a clause requiring the subcontractors to include these clauses in any lower tier subcontracts. The prime contractor shall be responsible for the compliance by any subcontractor or lower tier subcontractor with all of these contract clauses.

(3) *Breach.* A breach of the contract clauses above may be grounds for termination of the contract, and for debarment as a contractor and subcontractor as provided in 29 C.F.R. § 5.12."

5. **Contract Work Hours and Safety Standards Act.**

- a. **Applicability:** This requirement applies to all Federal grant and cooperative agreement programs.
- b. **Standard.** Where applicable (see 40 U.S.C. § 3701), all contracts awarded by the non-Federal entity in excess of \$100,000 that involve the employment of mechanics or laborers must include a provision for compliance with 40 U.S.C. §§ 3702 and 3704, as supplemented by Department of Labor regulations at 29 C.F.R. Part 5. See 2 C.F.R. Part 200, Appendix II, ¶ E.

Under 40 U.S.C. § 3702, each contractor must be required to compute the wages of every mechanic and laborer on the basis of a standard work week of 40 hours. Work in excess of the standard work week is permissible provided that the worker is compensated at a rate of not less than one and a half times the basic rate of pay for all hours worked in excess of 40 hours in the work week.

The requirements of 40 U.S.C. § 3704 are applicable to construction work and provide that no laborer or mechanic must be required to work in surroundings or under working conditions which are unsanitary, hazardous or dangerous. These requirements do not apply to the purchases of

Program, and Federal Assistance to Individuals and Households – Other Needs Assistance Grant Program, as FEMA or Federal awards under these programs do not meet the definition of “funding agreement.”

- b. Standard. If the FEMA or Federal award meets the definition of “funding agreement” under 37 C.F.R. § 401.2(a) and the non-Federal entity wishes to enter into a contract with a small business firm or nonprofit organization regarding the substitution of parties, assignment or performance of experimental, developmental, or research work under that “funding agreement,” the non-Federal entity must comply with the requirements of 37 C.F.R. Part 401 (Rights to Inventions Made by Nonprofit Organizations and Small Business Firms Under Government Grants, Contracts and Cooperative Agreements), and any implementing regulations issued by FEMA or applicable awarding agency. See 2 C.F.R. Part 200, Appendix II, ¶ F.
- c. Key Definition: The regulation at 37 C.F.R. § 401.2(a) currently defines “funding agreement” as any contract, grant, or cooperative agreement entered into between any Federal agency, other than the Tennessee Valley Authority, and any contractor for the performance of experimental, developmental, or research work funded in whole or in part by the Federal government. This term also includes any assignment, substitution of parties, or subcontract of any type entered into for the performance of experimental, developmental, or research work under a funding agreement as defined in the first sentence of this paragraph.

7. Clean Air Act and the Federal Water Pollution Control Act.

- a. Applicability and Standard: Contracts of amounts in excess of \$150,000 must contain a provision that requires the contractor to agree to comply with all applicable standards, orders, or regulations issued pursuant to the Clean Air Act (42 U.S.C. §§ 7401-7671q) and the Federal Water Pollution Control Act as amended (33 U.S.C. §§ 1251-1387). Violations must be reported to the Federal awarding agency and the Regional Office of the Environmental Protection Agency. See 2 C.F.R. Part 200, Appendix II, ¶ G.
- b. Statement: Included in contracts as provided in section “7a” above.
  - (1) The contractor agrees to comply with all applicable standards, orders or regulations issued pursuant to the Clean Air Act, as amended, 42 U.S.C. § 7401 et seq. and the Federal Water Pollution Control Act, as amended, 33 U.S.C. 1251 et seq.
  - (2) The contractor agrees to report each violation to the Federal awarding agency (e.g. Federal Emergency Management Agency-FEMA) and the Regional Office of the Environmental Protection Agency. Contractor understands and agrees that each violation reported to the County of Hidalgo will, in turn, be reported as required to assure notification to the Federal awarding agency and the appropriate Environmental Protection Agency Regional Office.
  - (3) The contractor agrees to include these requirements in each subcontract exceeding \$150,000 financed in whole or in part with Federal assistance provided by the applicable Federal awarding agency (e.g. FEMA).

8. Debarment and Suspension.

- a. Applicability: This requirement applies to all Federal grant and cooperative agreement programs.

- b. Standard. Non-Federal entities and contractors are subject to the debarment and suspension regulations implementing Executive Order 12549, *Debarment and Suspension* (1986) and Executive Order 12689, *Debarment and Suspension* (1989) at 2 C.F.R. Part 180 and the Department of Homeland Security's regulations at 2 C.F.R. Part 3000 (Nonprocurement Debarment and Suspension).

These regulations restrict awards, subawards, and contracts with certain parties that are debarred, suspended, or otherwise excluded from or ineligible for participation in Federal assistance programs and activities. See 2 C.F.R. Part 200, Appendix II, ¶ H; and Chapter IV, ¶ 6.d and Appendix C, ¶ 2. A contract award must not be made to parties listed in the SAM Exclusions. SAM Exclusions is the list maintained by the General Services Administration that contains the names of parties debarred, suspended, or otherwise excluded by agencies, as well as parties declared ineligible under statutory or regulatory authority other than Executive Order 12549. SAM exclusions can be accessed at [www.sam.gov](http://www.sam.gov). See 2 C.F.R. § 180.530; Chapter IV, ¶ 6.d and Appendix C, ¶ 2.

In general, an "excluded" party cannot receive a Federal grant award or a contract within the meaning of a "covered transaction," to include subawards and subcontracts. This includes parties that receive Federal funding indirectly, such as contractors to recipients and subrecipients. The key to the exclusion is whether there is a "covered transaction," which is any nonprocurement transaction (unless excepted) at either a "primary" or "secondary" tier. Although "covered transactions" do not include contracts awarded by the Federal Government for purposes of the nonprocurement common rule and DHS's implementing regulations, it does include some contracts awarded by recipients and subrecipient.

Specifically, a covered transaction includes the following contracts for goods or services:

- (1) The contract is awarded by a recipient or subrecipient in the amount of at least \$25,000.
  - (2) The contract requires the approval of FEMA or applicable Federal entity, regardless of amount.
  - (3) The contract is for Federally-required audit services.
  - (4) A subcontract is also a covered transaction if it is awarded by the contractor of a recipient or subrecipient and requires either the approval of FEMA or applicable Federal entity or is in excess of \$25,000.
- c. Statement. The following provides a debarment and suspension clause. It incorporates a method of verifying that contractors are not excluded or disqualified:

For maximum protection, provide a print or electronic document for every prime and subcontractor, from [www.sam.gov](http://www.sam.gov) in order to ensure that they are not debarred, suspended, or otherwise excluded from or ineligible for participation in Federal assistance programs and activities.

This contract is a covered transaction for purposes of 2 C.F.R. pt. 180 and 2 C.F.R. pt. 3000. As such the contractor is required to verify that none of the contractor, its principals (defined at 2 C.F.R. § 180.995), or its affiliates (defined at 2 C.F.R. § 180.905) are excluded (defined at 2 C.F.R. 180.940) or disqualified (defined at 2 C.F.R. § 180.935).

The contractor must comply with 2 C.F.R. pt. 180, subpart C and 2 C.F.R. pt. 3000, subpart C and must include a requirement to comply with these regulations in any lower tier covered transaction it enters into.

This certification is a material representation of fact relied upon by (insert name of subrecipient). If it is later determined that the contractor did not comply with 2 C.F.R. pt. 180, subpart C and 2 C.F.R. pt. 3000, subpart C, in addition to remedies available to (name of state agency serving as recipient and name of subrecipient), the Federal Government may pursue available remedies, including but not limited to suspension and/or debarment.

The bidder or proposer agrees to comply with the requirements of 2 C.F.R. pt. 180, subpart C and 2 C.F.R. pt. 3000, subpart C while this offer is valid and throughout the period of any contract that may arise from this offer. The bidder or proposer further agrees to include a provision requiring such compliance in its lower tier covered transactions.”

9. Byrd Anti-Lobbying Amendment.

- a. Applicability: This requirement applies to all Federal grant and cooperative agreement programs.
- b. Standard. Contractors that apply or bid for an award of \$100,000 or more must file the required certification. See 2 C.F.R. Part 200, Appendix II, ¶ I; 44 C.F.R. Part 18; Chapter IV, 6.c; Appendix C, ¶ 4. Each tier certifies to the tier above that it will not and has not used Federal appropriated funds to pay any person or organization for influencing or attempting to influence an officer or employee of any City, a member of Congress, officer or employee of Congress, or an employee of a member of Congress in connection with obtaining any Federal contract, grant or any other award covered by 31 U.S.C. § 1352. Each tier must also disclose any lobbying with non-Federal funds that takes place in connection with obtaining any Federal award. Such disclosures are forwarded from tier to tier up to the non-Federal award. See Chapter IV, ¶ 6.c and Appendix C, ¶ 4.
- c. Statement. The following statement in bold provides a Byrd Anti-Lobbying contract clause:

(IF APPLICABLE, PLEASE FILL IN BLANKS AND SIGN)

“Byrd Anti-Lobbying Amendment, 31 U.S.C. § 1352 (as amended)

**Contractors who apply or bid for an award of \$100,000 or more shall file the required certification. Each tier certifies to the tier above that it will not and has not used Federal appropriated funds to pay any person or organization for influencing or attempting to influence an officer or employee of any agency, a member of Congress, officer or employee of Congress, or an employee of a member of Congress in connection with obtaining any Federal contract, grant, or any other award covered by 31 U.S.C. § 1352. Each tier shall also disclose any lobbying with non-Federal funds that takes place in connection with obtaining any Federal award. Such disclosures are forwarded from tier to tier up to the recipient.”**

APPENDIX A, 44 C.F.R. PART 18 – CERTIFICATION REGARDING LOBBYING

**Certification for Contracts, Grants, Loans, and Cooperative Agreements**

(To be submitted with each bid or offer exceeding \$100,000)

The undersigned Contractor, \_\_\_\_\_  
certifies, to the best of his or her knowledge, that:

1. No Federal appropriated funds have been paid or will be paid, by or on behalf of the undersigned, to any person for influencing or attempting to influence an officer or employee of an agency, a Member of Congress, an officer or employee of Congress, or an employee of a Member of Congress in connection with the awarding of any Federal contract, the making of any Federal grant, the making of any Federal loan, the entering into of any cooperative agreement, and the extension, continuation, renewal, amendment, or modification of any Federal contract, grant, loan, or cooperative agreement.

2. If any funds other than Federal appropriated funds have been paid or will be paid to any person for influencing or attempting to influence an officer or employee of any agency, a Member of Congress, an officer or employee of Congress, or an employee of a Member of Congress in connection with this Federal contract, grant, loan, or cooperative agreement, the undersigned shall complete and submit Standard Form-LLL, "Disclosure Form to Report Lobbying," in accordance with its instructions.

3. The undersigned shall require that the language of this certification be included in the award documents for all subawards at all tiers (including subcontracts, subgrants, and contracts under grants, loans, and cooperative agreements) and that all subrecipients shall certify and disclose accordingly.

This certification is a material representation of fact upon which reliance was placed when this transaction was made or entered into. Submission of this certification is a prerequisite for making or entering into this transaction imposed by 31, U.S.C. § 1352 (as amended by the Lobbying Disclosure Act of 1995). Any person who fails to file the required certification shall be subject to a civil penalty of not less than \$10,000 and not more than \$100,000 for each such failure.

The Contractor, \_\_\_\_\_, certifies or affirms the truthfulness and accuracy of each statement of its certification and disclosure, if any. In addition, the Contractor understands and agrees that the provisions of 31 U.S.C. § 3801 *et seq.*, apply to this certification and disclosure, if any.

\_\_\_\_\_  
Signature of Contractor's Authorized Official

\_\_\_\_\_  
Name and Title of Contractor's Authorized Official

\_\_\_\_\_  
Date

10. Procurement of Recovered Materials.

- a. Applicability: This requirement applies to all Federal grant and cooperative agreement programs.
- b. Standard. A non-Federal entity that is a **state agency or agency of a political subdivision** of a state and its contractors must comply with Section 6002 of the Solid Waste Disposal Act, Pub. L. No. 89-272 (1965) (codified as amended by the Resource Conservation and Recovery Act at 42 U.S.C. § 6962). See 2 C.F.R. Part 200, Appendix II, ¶ J; 2 C.F.R. § 200.322; *PDAT Supplement*, Chapter V, ¶ 7.

The requirements of Section 6002 include procuring only items designated in guidelines of the EPA at 40 C.F.R. Part 247 that contain the highest percentage of recovered materials practicable, consistent with maintaining a satisfactory level of competition, where the purchase price of the item exceeds \$10,000 or the value of the quantity acquired by the preceding fiscal year exceeded \$10,000; procuring solid waste management services in a manner that maximizes energy and resource recovery; and establishing an affirmative procurement program for procurement of recovered materials identified in the EPA guidelines.

- c. Statement. The following provides the clause that a state agency or agency of a political subdivision of a state and its contractors can include in contracts meeting the above contract thresholds:

“(1) In the performance of this contract, the Contractor shall make maximum use of products containing recovered materials that are EPA- designated items unless the product cannot be acquired—

- (i) Competitively within a timeframe providing for compliance with the contract performance schedule;
- (ii) Meeting contract performance requirements; or
- (iii) At a reasonable price.

- (3) Information about this requirement, along with the list of EPA-designate items, is available at EPA’s Comprehensive Procurement Guidelines web site, <https://www.epa.gov/smm/comprehensive-procurement-guideline-cpg-program>.”

**Additional Required Contract Clauses for Non-Federal Entity Contracts Under Federal Awards with the Federal Emergency Management Agency (FEMA)**

Additional FEMA or applicable Federal Requirements. In addition to the requirements above, non-Federal entity contracts under Federal award subject to financial assistance from FEMA are required to contain the following additional contract clauses. The Uniform Guidance authorizes FEMA to require additional provisions for non-Federal entity contracts. FEMA, pursuant to this authority, requires or recommends the following:

*These clauses are incorporated by reference as part of this procurement packet and any resulting agreement.*

11. Changes.

- a. Standard. To be eligible for FEMA assistance under the non-Federal entity's Federal grant or cooperative agreement, the cost of the change, modification, change order, or constructive change must be allowable, allocable, within the scope of its grant or cooperative agreement, and reasonable for the completion of project scope. FEMA or applicable Federal entity recommends, therefore, that a non-Federal entity include a changes clause in its contract that describes how, if at all, changes can be made by either party to alter the method, price, or schedule of the work without breaching the contract. The language of the clause may differ depending on the nature of the contract and the end-item procured.
- b. Statement. The following provides a contract clause regarding access to records:

"The contractor shall secure written authorization before proceeding with any additional work, whether requested by the County or required to complete the contract. The cost for any changes to the contract price, whether requested by the County or the Contractor will be approved only after submitting the contractor's true costs for the work and related equipment costs and site expenses."

12. Access to Records.

- a. Standard. All non-Federal entities must place into their contracts a provision that all contractors and their successors, transferees, assignees, and subcontractors acknowledge and agree to comply with applicable provisions governing Department and FEMA or applicable Federal entity access to records, accounts, documents, information, facilities, and staff. See DHS Standard Terms and Conditions, v 3.0, ¶ XXVI (2013).
- b. Statement. The following provides a contract clause regarding access to records:

"Access to Records. The following access to records requirements apply to this contract:

(1) The contractor agrees to provide the County of Hidalgo, the FEMA or applicable Federal Administrator, the Comptroller General of the United States, or any of their authorized representatives access to any books, documents, papers, and records of the Contractor which are directly pertinent to this contract for the purposes of making audits, examinations, excerpts, and transcriptions.

(2) The Contractor agrees to permit any of the foregoing parties to reproduce by any means whatsoever or to copy excerpts and transcriptions as reasonably needed.

(3) The contractor agrees to provide the FEMA or applicable Federal Administrator or his authorized representatives access to construction or other work sites pertaining to the work being completed under the contract."

13. DHS Seal, Logo, and Flags.

- a. Standard. All non-Federal entities must place in their contracts a provision that a contractor shall not use the DHS seal(s), logos, crests, or reproductions of flags or likenesses of DHS City

officials without specific FEMA or applicable Federal entity pre-approval. See DHS Standard Terms and Conditions, v3.0, ¶ XXV (2013).

- b. Statement. The following provides a contract clause regarding DHS Seal, Logo, and Flags:

“The contractor shall not use the DHS seal(s), logos, crests, or reproductions of flags or likenesses of DHS City officials without specific FEMA or applicable Federal entity pre-approval.”

**14. Compliance with Federal Law, Regulations, and Executive Orders.**

- a. Standard. All non-Federal entities must place into their contracts an acknowledgement that FEMA or applicable Federal financial assistance will be used to fund the contract along with the requirement that the contractor will comply with all applicable Federal law, regulations, executive orders, and FEMA or applicable Federal policies, procedures, and directives.

- b. Statement. The following provides a contract clause regarding Compliance with Federal Law, Regulations and Executive Orders:

“This is an acknowledgement that Federal financial assistance will be used to fund the contract only. The contractor will comply will all applicable Federal law, regulations, executive orders, FEMA or applicable Federal policies, procedures, and directives.”

**15. No Obligation by Federal Government.**

- a. Standard. The non-Federal entity must include a provision in its contract that states that the Federal Government is not a party to the contract and is not subject to any obligations or liabilities to the non-Federal entity, contractor, or any other party pertaining to any matter resulting from the contract.

- b. Statement. The following provides a contract clause regarding no obligation by the Federal Government:

“The Federal Government is not a party to this contract and is not subject to any obligations or liabilities to the non-Federal entity, contractor, or any other party pertaining to any matter resulting from the contract.”

**16. Program Fraud and False or Fraudulent Statements or Related Acts.**

- a. Standard. The non-Federal entity must include a provision in its contract that the contractor acknowledges that 31 U.S.C. Chap. 38 (Administrative Remedies for False Claims and Statements) applies to its actions pertaining to the contract.

- b. Statement. The following provides a contract clause regarding Fraud and False or Fraudulent Related Acts:

“The contractor acknowledges that 31 U.S.C. Chap. 38 (Administrative Remedies for False Claims and Statements) applies to the contractor’s actions pertaining to this contract.”

**Contractor agrees to comply with all federal, state and local laws, rules, regulations and ordinances, as applicable. It is further acknowledged that the Contractor read and understands all provisions, laws, acts, regulations, etc. as specifically noted above and certifies compliance with the same.**

Vendor's Name/Company Name: \_\_\_\_\_

Printed Name and Title of Authorized Representative: \_\_\_\_\_

Signature of Authorized Representative: \_\_\_\_\_

Date: \_\_\_\_\_

# Exhibit "I"

EHWA 1273

**REQUIRED CONTRACT PROVISIONS  
FEDERAL-AID CONSTRUCTION CONTRACTS**

- I. General
- II. Nondiscrimination
- III. Nonsegregated Facilities
- IV. Davis-Bacon and Related Act Provisions
- V. Contract Work Hours and Safety Standards Act Provisions
- VI. Subletting or Assigning the Contract
- VII. Safety: Accident Prevention
- VIII. False Statements Concerning Highway Projects
- IX. Implementation of Clean Air Act and Federal Water Pollution Control Act
- X. Compliance with Governmentwide Suspension and Debarment Requirements
- XI. Certification Regarding Use of Contract Funds for Lobbying

**ATTACHMENTS**

A. Employment and Materials Preference for Appalachian Development Highway System or Appalachian Local Access Road Contracts (included in Appalachian contracts only)

**I. GENERAL**

1. Form FHWA-1273 must be physically incorporated in each construction contract funded under Title 23 (excluding emergency contracts solely intended for debris removal). The contractor (or subcontractor) must insert this form in each subcontract and further require its inclusion in all lower tier subcontracts (excluding purchase orders, rental agreements and other agreements for supplies or services).

The applicable requirements of Form FHWA-1273 are incorporated by reference for work done under any purchase order, rental agreement or agreement for other services. The prime contractor shall be responsible for compliance by any subcontractor, lower-tier subcontractor or service provider.

Form FHWA-1273 must be included in all Federal-aid design-build contracts, in all subcontracts and in lower tier subcontracts (excluding subcontracts for design services, purchase orders, rental agreements and other agreements for supplies or services). The design-builder shall be responsible for compliance by any subcontractor, lower-tier subcontractor or service provider.

Contracting agencies may reference Form FHWA-1273 in bid proposal or request for proposal documents, however, the Form FHWA-1273 must be physically incorporated (not referenced) in all contracts, subcontracts and lower-tier subcontracts (excluding purchase orders, rental agreements and other agreements for supplies or services related to a construction contract).

2. Subject to the applicability criteria noted in the following sections, these contract provisions shall apply to all work performed on the contract by the contractor's own organization and with the assistance of workers under the contractor's immediate superintendence and to all work performed on the contract by piecework, station work, or by subcontract.

3. A breach of any of the stipulations contained in these Required Contract Provisions may be sufficient grounds for withholding of progress payments, withholding of final payment, termination of the contract, suspension / debarment or any other action determined to be appropriate by the contracting agency and FHWA.

4. Selection of Labor: During the performance of this contract, the contractor shall not use convict labor for any purpose within the limits of a construction project on a Federal-aid highway unless it is labor performed by convicts who are on parole, supervised release, or probation. The term Federal-aid highway does not include roadways functionally classified as local roads or rural minor collectors.

**II. NONDISCRIMINATION**

The provisions of this section related to 23 CFR Part 230 are applicable to all Federal-aid construction contracts and to all related construction subcontracts of \$10,000 or more. The provisions of 23 CFR Part 230 are not applicable to material supply, engineering, or architectural service contracts.

In addition, the contractor and all subcontractors must comply with the following policies: Executive Order 11246, 41 CFR 60, 29 CFR 1625-1627, Title 23 USC Section 140, the Rehabilitation Act of 1973, as amended (29 USC 794), Title VI of the Civil Rights Act of 1964, as amended, and related regulations including 49 CFR Parts 21, 26 and 27; and 23 CFR Parts 200, 230, and 633.

The contractor and all subcontractors must comply with: the requirements of the Equal Opportunity Clause in 41 CFR 60-1.4(b) and, for all construction contracts exceeding \$10,000, the Standard Federal Equal Employment Opportunity Construction Contract Specifications in 41 CFR 60-4.3.

Note: The U.S. Department of Labor has exclusive authority to determine compliance with Executive Order 11246 and the policies of the Secretary of Labor including 41 CFR 60, and 29 CFR 1625-1627. The contracting agency and the FHWA have the authority and the responsibility to ensure compliance with Title 23 USC Section 140, the Rehabilitation Act of 1973, as amended (29 USC 794), and Title VI of the Civil Rights Act of 1964, as amended, and related regulations including 49 CFR Parts 21, 26 and 27; and 23 CFR Parts 200, 230, and 633.

The following provision is adopted from 23 CFR 230, Appendix A, with appropriate revisions to conform to the U.S. Department of Labor (US DOL) and FHWA requirements.

**1. Equal Employment Opportunity:** Equal employment opportunity (EEO) requirements not to discriminate and to take affirmative action to assure equal opportunity as set forth under laws, executive orders, rules, regulations (28 CFR 35, 29 CFR 1630, 29 CFR 1625-1627, 41 CFR 60 and 49 CFR 27) and orders of the Secretary of Labor as modified by the provisions prescribed herein, and imposed pursuant to 23 U.S.C. 140 shall constitute the EEO and specific affirmative action standards for the contractor's project activities under

this contract. The provisions of the Americans with Disabilities Act of 1990 (42 U.S.C. 12101 et seq.) set forth under 28 CFR 35 and 29 CFR 1630 are incorporated by reference in this contract. In the execution of this contract, the contractor agrees to comply with the following minimum specific requirement activities of EEO:

a. The contractor will work with the contracting agency and the Federal Government to ensure that it has made every good faith effort to provide equal opportunity with respect to all of its terms and conditions of employment and in their review of activities under the contract.

b. The contractor will accept as its operating policy the following statement:

"It is the policy of this Company to assure that applicants are employed, and that employees are treated during employment, without regard to their race, religion, sex, color, national origin, age or disability. Such action shall include: employment, upgrading, demotion, or transfer; recruitment or recruitment advertising; layoff or termination; rates of pay or other forms of compensation; and selection for training, including apprenticeship, pre-apprenticeship, and/or on-the-job training."

2. **EEO Officer:** The contractor will designate and make known to the contracting officers an EEO Officer who will have the responsibility for and must be capable of effectively administering and promoting an active EEO program and who must be assigned adequate authority and responsibility to do so.

3. **Dissemination of Policy:** All members of the contractor's staff who are authorized to hire, supervise, promote, and discharge employees, or who recommend such action, or who are substantially involved in such action, will be made fully cognizant of, and will implement, the contractor's EEO policy and contractual responsibilities to provide EEO in each grade and classification of employment. To ensure that the above agreement will be met, the following actions will be taken as a minimum:

a. Periodic meetings of supervisory and personnel office employees will be conducted before the start of work and then not less often than once every six months, at which time the contractor's EEO policy and its implementation will be reviewed and explained. The meetings will be conducted by the EEO Officer.

b. All new supervisory or personnel office employees will be given a thorough indoctrination by the EEO Officer, covering all major aspects of the contractor's EEO obligations within thirty days following their reporting for duty with the contractor.

c. All personnel who are engaged in direct recruitment for the project will be instructed by the EEO Officer in the contractor's procedures for locating and hiring minorities and women.

d. Notices and posters setting forth the contractor's EEO policy will be placed in areas readily accessible to employees, applicants for employment and potential employees.

e. The contractor's EEO policy and the procedures to implement such policy will be brought to the attention of employees by means of meetings, employee handbooks, or other appropriate means.

4. **Recruitment:** When advertising for employees, the contractor will include in all advertisements for employees the notation: "An Equal Opportunity Employer." All such advertisements will be placed in publications having a large circulation among minorities and women in the area from which the project work force would normally be derived.

a. The contractor will, unless precluded by a valid bargaining agreement, conduct systematic and direct recruitment through public and private employee referral sources likely to yield qualified minorities and women. To meet this requirement, the contractor will identify sources of potential minority group employees, and establish with such identified sources procedures whereby minority and women applicants may be referred to the contractor for employment consideration.

b. In the event the contractor has a valid bargaining agreement providing for exclusive hiring hall referrals, the contractor is expected to observe the provisions of that agreement to the extent that the system meets the contractor's compliance with EEO contract provisions. Where implementation of such an agreement has the effect of discriminating against minorities or women, or obligates the contractor to do the same, such implementation violates Federal nondiscrimination provisions.

c. The contractor will encourage its present employees to refer minorities and women as applicants for employment. Information and procedures with regard to referring such applicants will be discussed with employees.

5. **Personnel Actions:** Wages, working conditions, and employee benefits shall be established and administered, and personnel actions of every type, including hiring, upgrading, promotion, transfer, demotion, layoff, and termination, shall be taken without regard to race, color, religion, sex, national origin, age or disability. The following procedures shall be followed:

a. The contractor will conduct periodic inspections of project sites to insure that working conditions and employee facilities do not indicate discriminatory treatment of project site personnel.

b. The contractor will periodically evaluate the spread of wages paid within each classification to determine any evidence of discriminatory wage practices.

c. The contractor will periodically review selected personnel actions in depth to determine whether there is evidence of discrimination. Where evidence is found, the contractor will promptly take corrective action. If the review indicates that the discrimination may extend beyond the actions reviewed, such corrective action shall include all affected persons.

d. The contractor will promptly investigate all complaints of alleged discrimination made to the contractor in connection with its obligations under this contract, will attempt to resolve such complaints, and will take appropriate corrective action within a reasonable time. If the investigation indicates that the discrimination may affect persons other than the complainant, such corrective action shall include such other persons. Upon completion of each investigation, the contractor will inform every complainant of all of their avenues of appeal.

6. **Training and Promotion:**

a. The contractor will assist in locating, qualifying, and increasing the skills of minorities and women who are

applicants for employment or current employees. Such efforts should be aimed at developing full journey level status employees in the type of trade or job classification involved.

b. Consistent with the contractor's work force requirements and as permissible under Federal and State regulations, the contractor shall make full use of training programs, i.e., apprenticeship, and on-the-job training programs for the geographical area of contract performance. In the event a special provision for training is provided under this contract, this subparagraph will be superseded as indicated in the special provision. The contracting agency may reserve training positions for persons who receive welfare assistance in accordance with 23 U.S.C. 140(a).

c. The contractor will advise employees and applicants for employment of available training programs and entrance requirements for each.

d. The contractor will periodically review the training and promotion potential of employees who are minorities and women and will encourage eligible employees to apply for such training and promotion.

**7. Unions:** If the contractor relies in whole or in part upon unions as a source of employees, the contractor will use good faith efforts to obtain the cooperation of such unions to increase opportunities for minorities and women. Actions by the contractor, either directly or through a contractor's association acting as agent, will include the procedures set forth below:

a. The contractor will use good faith efforts to develop, in cooperation with the unions, joint training programs aimed toward qualifying more minorities and women for membership in the unions and increasing the skills of minorities and women so that they may qualify for higher paying employment.

b. The contractor will use good faith efforts to incorporate an EEO clause into each union agreement to the end that such union will be contractually bound to refer applicants without regard to their race, color, religion, sex, national origin, age or disability.

c. The contractor is to obtain information as to the referral practices and policies of the labor union except that to the extent such information is within the exclusive possession of the labor union and such labor union refuses to furnish such information to the contractor, the contractor shall so certify to the contracting agency and shall set forth what efforts have been made to obtain such information.

d. In the event the union is unable to provide the contractor with a reasonable flow of referrals within the time limit set forth in the collective bargaining agreement, the contractor will, through independent recruitment efforts, fill the employment vacancies without regard to race, color, religion, sex, national origin, age or disability; making full efforts to obtain qualified and/or qualified minorities and women. The failure of a union to provide sufficient referrals (even though it is obligated to provide exclusive referrals under the terms of a collective bargaining agreement) does not relieve the contractor from the requirements of this paragraph. In the event the union referral practice prevents the contractor from meeting the obligations pursuant to Executive Order 11246, as amended, and these special provisions, such contractor shall immediately notify the contracting agency.

**8. Reasonable Accommodation for Applicants / Employees with Disabilities:** The contractor must be familiar

with the requirements for and comply with the Americans with Disabilities Act and all rules and regulations established there under. Employers must provide reasonable accommodation in all employment activities unless to do so would cause an undue hardship.

**9. Selection of Subcontractors, Procurement of Materials and Leasing of Equipment:** The contractor shall not discriminate on the grounds of race, color, religion, sex, national origin, age or disability in the selection and retention of subcontractors, including procurement of materials and leases of equipment. The contractor shall take all necessary and reasonable steps to ensure nondiscrimination in the administration of this contract.

a. The contractor shall notify all potential subcontractors and suppliers and lessors of their EEO obligations under this contract.

b. The contractor will use good faith efforts to ensure subcontractor compliance with their EEO obligations.

**10. Assurance Required by 49 CFR 26.13(b):**

a. The requirements of 49 CFR Part 26 and the State DOT's U.S. DOT-approved DBE program are incorporated by reference.

b. The contractor or subcontractor shall not discriminate on the basis of race, color, national origin, or sex in the performance of this contract. The contractor shall carry out applicable requirements of 49 CFR Part 26 in the award and administration of DOT-assisted contracts. Failure by the contractor to carry out these requirements is a material breach of this contract, which may result in the termination of this contract or such other remedy as the contracting agency deems appropriate.

**11. Records and Reports:** The contractor shall keep such records as necessary to document compliance with the EEO requirements. Such records shall be retained for a period of three years following the date of the final payment to the contractor for all contract work and shall be available at reasonable times and places for inspection by authorized representatives of the contracting agency and the FHWA.

a. The records kept by the contractor shall document the following:

(1) The number and work hours of minority and non-minority group members and women employed in each work classification on the project;

(2) The progress and efforts being made in cooperation with unions, when applicable, to increase employment opportunities for minorities and women; and

(3) The progress and efforts being made in locating, hiring, training, qualifying, and upgrading minorities and women;

b. The contractors and subcontractors will submit an annual report to the contracting agency each July for the duration of the project, indicating the number of minority, women, and non-minority group employees currently engaged in each work classification required by the contract work. This information is to be reported on Form FHWA-1391. The staffing data should represent the project work force on board in all or any part of the last payroll period preceding the end of July. If on-the-job training is being required by special provision, the contractor

will be required to collect and report training data. The employment data should reflect the work force on board during all or any part of the last payroll period preceding the end of July.

### III. NONSEGREGATED FACILITIES

This provision is applicable to all Federal-aid construction contracts and to all related construction subcontracts of \$10,000 or more.

The contractor must ensure that facilities provided for employees are provided in such a manner that segregation on the basis of race, color, religion, sex, or national origin cannot result. The contractor may neither require such segregated use by written or oral policies nor tolerate such use by employee custom. The contractor's obligation extends further to ensure that its employees are not assigned to perform their services at any location, under the contractor's control, where the facilities are segregated. The term "facilities" includes waiting rooms, work areas, restaurants and other eating areas, time clocks, restrooms, washrooms, locker rooms, and other storage or dressing areas, parking lots, drinking fountains, recreation or entertainment areas, transportation, and housing provided for employees. The contractor shall provide separate or single-user restrooms and necessary dressing or sleeping areas to assure privacy between sexes.

### IV. DAVIS-BACON AND RELATED ACT PROVISIONS

This section is applicable to all Federal-aid construction projects exceeding \$2,000 and to all related subcontracts and lower-tier subcontracts (regardless of subcontract size). The requirements apply to all projects located within the right-of-way of a roadway that is functionally classified as Federal-aid highway. This excludes roadways functionally classified as local roads or rural minor collectors, which are exempt. Contracting agencies may elect to apply these requirements to other projects.

The following provisions are from the U.S. Department of Labor regulations in 29 CFR 5.5 "Contract provisions and related matters" with minor revisions to conform to the FHWA-1273 format and FHWA program requirements.

#### 1. Minimum wages

a. All laborers and mechanics employed or working upon the site of the work, will be paid unconditionally and not less often than once a week, and without subsequent deduction or rebate on any account (except such payroll deductions as are permitted by regulations issued by the Secretary of Labor under the Copeland Act (29 CFR part 3)), the full amount of wages and bona fide fringe benefits (or cash equivalents thereof) due at time of payment computed at rates not less than those contained in the wage determination of the Secretary of Labor which is attached hereto and made a part hereof, regardless of any contractual relationship which may be alleged to exist between the contractor and such laborers and mechanics.

Contributions made or costs reasonably anticipated for bona fide fringe benefits under section 1(b)(2) of the Davis-Bacon Act on behalf of laborers or mechanics are considered wages paid to such laborers or mechanics, subject to the provisions

of paragraph 1.d. of this section; also, regular contributions made or costs incurred for more than a weekly period (but not less often than quarterly) under plans, funds, or programs which cover the particular weekly period, are deemed to be constructively made or incurred during such weekly period. Such laborers and mechanics shall be paid the appropriate wage rate and fringe benefits on the wage determination for the classification of work actually performed, without regard to skill, except as provided in 29 CFR 5.5(a)(4). Laborers or mechanics performing work in more than one classification may be compensated at the rate specified for each classification for the time actually worked thereon: Provided, That the employer's payroll records accurately set forth the time spent in each classification in which work is performed. The wage determination (including any additional classification and wage rates conformed under paragraph 1.b. of this section) and the Davis-Bacon poster (WH-1321) shall be posted at all times by the contractor and its subcontractors at the site of the work in a prominent and accessible place where it can be easily seen by the workers.

b.(1) The contracting officer shall require that any class of laborers or mechanics, including helpers, which is not listed in the wage determination and which is to be employed under the contract shall be classified in conformance with the wage determination. The contracting officer shall approve an additional classification and wage rate and fringe benefits therefore only when the following criteria have been met:

(i) The work to be performed by the classification requested is not performed by a classification in the wage determination; and

(ii) The classification is utilized in the area by the construction industry; and

(iii) The proposed wage rate, including any bona fide fringe benefits, bears a reasonable relationship to the wage rates contained in the wage determination.

(2) If the contractor and the laborers and mechanics to be employed in the classification (if known), or their representatives, and the contracting officer agree on the classification and wage rate (including the amount designated for fringe benefits where appropriate), a report of the action taken shall be sent by the contracting officer to the Administrator of the Wage and Hour Division, Employment Standards Administration, U.S. Department of Labor, Washington, DC 20210. The Administrator, or an authorized representative, will approve, modify, or disapprove every additional classification action within 30 days of receipt and so advise the contracting officer or will notify the contracting officer within the 30-day period that additional time is necessary.

(3) In the event the contractor, the laborers or mechanics to be employed in the classification or their representatives, and the contracting officer do not agree on the proposed classification and wage rate (including the amount designated for fringe benefits, where appropriate), the contracting officer shall refer the questions, including the views of all interested parties and the recommendation of the contracting officer, to the Wage and Hour Administrator for determination. The Wage and Hour Administrator, or an authorized representative, will issue a determination within 30 days of receipt and so advise the contracting officer or

will notify the contracting officer within the 30-day period that additional time is necessary.

(4) The wage rate (including fringe benefits where appropriate) determined pursuant to paragraphs 1.b.(2) or 1.b.(3) of this section, shall be paid to all workers performing work in the classification under this contract from the first day on which work is performed in the classification.

c. Whenever the minimum wage rate prescribed in the contract for a class of laborers or mechanics includes a fringe benefit which is not expressed as an hourly rate, the contractor shall either pay the benefit as stated in the wage determination or shall pay another bona fide fringe benefit or an hourly cash equivalent thereof.

d. If the contractor does not make payments to a trustee or other third person, the contractor may consider as part of the wages of any laborer or mechanic the amount of any costs reasonably anticipated in providing bona fide fringe benefits under a plan or program. Provided, That the Secretary of Labor has found, upon the written request of the contractor, that the applicable standards of the Davis-Bacon Act have been met. The Secretary of Labor may require the contractor to set aside in a separate account assets for the meeting of obligations under the plan or program.

## 2. Withholding

The contracting agency shall upon its own action or upon written request of an authorized representative of the Department of Labor, withhold or cause to be withheld from the contractor under this contract, or any other Federal contract with the same prime contractor, or any other federally-assisted contract subject to Davis-Bacon prevailing wage requirements, which is held by the same prime contractor, so much of the accrued payments or advances as may be considered necessary to pay laborers and mechanics, including apprentices, trainees, and helpers, employed by the contractor or any subcontractor the full amount of wages required by the contract. In the event of failure to pay any laborer or mechanic, including any apprentice, trainee, or helper, employed or working on the site of the work, all or part of the wages required by the contract, the contracting agency may, after written notice to the contractor, take such action as may be necessary to cause the suspension of any further payment, advance, or guarantee of funds until such violations have ceased.

## 3. Payrolls and basic records

a. Payrolls and basic records relating thereto shall be maintained by the contractor during the course of the work and preserved for a period of three years thereafter for all laborers and mechanics working at the site of the work. Such records shall contain the name, address, and social security number of each such worker, his or her correct classification, hourly rates of wages paid (including rates of contributions or costs anticipated for bona fide fringe benefits or cash equivalents thereof of the types described in section 1(b)(2)(B) of the Davis-Bacon Act), daily and weekly number of hours worked, deductions made and actual wages paid. Whenever the Secretary of Labor has found under 29 CFR 5.5(a)(1)(iv) that the wages of any laborer or mechanic include the amount of any costs reasonably anticipated in providing benefits under a plan or program described in section 1(b)(2)(B) of the Davis-

Bacon Act, the contractor shall maintain records which show that the commitment to provide such benefits is enforceable, that the plan or program is financially responsible, and that the plan or program has been communicated in writing to the laborers or mechanics affected, and records which show the costs anticipated or the actual cost incurred in providing such benefits. Contractors employing apprentices or trainees under approved programs shall maintain written evidence of the registration of apprenticeship programs and certification of trainee programs, the registration of the apprentices and trainees, and the ratios and wage rates prescribed in the applicable programs.

b.(1) The contractor shall submit weekly for each week in which any contract work is performed a copy of all payrolls to the contracting agency. The payrolls submitted shall set out accurately and completely all of the information required to be maintained under 29 CFR 5.5(a)(3)(i), except that full social security numbers and home addresses shall not be included on weekly transmittals. Instead the payrolls shall only need to include an individually identifying number for each employee (e.g., the last four digits of the employee's social security number). The required weekly payroll information may be submitted in any form desired. Optional Form WH-347 is available for this purpose from the Wage and Hour Division Web site at <http://www.dol.gov/esa/whd/forms/wh347instr.htm> or its successor site. The prime contractor is responsible for the submission of copies of payrolls by all subcontractors. Contractors and subcontractors shall maintain the full social security number and current address of each covered worker, and shall provide them upon request to the contracting agency for transmission to the State DOT, the FHWA or the Wage and Hour Division of the Department of Labor for purposes of an investigation or audit of compliance with prevailing wage requirements. It is not a violation of this section for a prime contractor to require a subcontractor to provide addresses and social security numbers to the prime contractor for its own records, without weekly submission to the contracting agency..

(2) Each payroll submitted shall be accompanied by a "Statement of Compliance," signed by the contractor or subcontractor or his or her agent who pays or supervises the payment of the persons employed under the contract and shall certify the following:

(i) That the payroll for the payroll period contains the information required to be provided under §5.5 (a)(3)(ii) of Regulations, 29 CFR part 5, the appropriate information is being maintained under §5.5 (a)(3)(i) of Regulations, 29 CFR part 5, and that such information is correct and complete;

(ii) That each laborer or mechanic (including each helper, apprentice, and trainee) employed on the contract during the payroll period has been paid the full weekly wages earned, without rebate, either directly or indirectly, and that no deductions have been made either directly or indirectly from the full wages earned, other than permissible deductions as set forth in Regulations, 29 CFR part 3;

(iii) That each laborer or mechanic has been paid not less than the applicable wage rates and fringe benefits or cash equivalents for the classification of work performed, as specified in the applicable wage determination incorporated into the contract.

(3) The weekly submission of a properly executed certification set forth on the reverse side of Optional Form WH-347 shall satisfy the requirement for submission of the "Statement of Compliance" required by paragraph 3.b.(2) of this section.

(4) The falsification of any of the above certifications may subject the contractor or subcontractor to civil or criminal prosecution under section 1001 of title 18 and section 231 of title 31 of the United States Code.

c. The contractor or subcontractor shall make the records required under paragraph 3.a. of this section available for inspection, copying, or transcription by authorized representatives of the contracting agency, the State DOT, the FHWA, or the Department of Labor, and shall permit such representatives to interview employees during working hours on the job. If the contractor or subcontractor fails to submit the required records or to make them available, the FHWA may, after written notice to the contractor, the contracting agency or the State DOT, take such action as may be necessary to cause the suspension of any further payment, advance, or guarantee of funds. Furthermore, failure to submit the required records upon request or to make such records available may be grounds for debarment action pursuant to 29 CFR 5.12.

#### 4. Apprentices and trainees

##### a. Apprentices (programs of the USDOL).

Apprentices will be permitted to work at less than the predetermined rate for the work they performed when they are employed pursuant to and individually registered in a bona fide apprenticeship program registered with the U.S. Department of Labor, Employment and Training Administration, Office of Apprenticeship Training, Employer and Labor Services, or with a State Apprenticeship Agency recognized by the Office, or if a person is employed in his or her first 90 days of probationary employment as an apprentice in such an apprenticeship program, who is not individually registered in the program, but who has been certified by the Office of Apprenticeship Training, Employer and Labor Services or a State Apprenticeship Agency (where appropriate) to be eligible for probationary employment as an apprentice.

The allowable ratio of apprentices to journeymen on the job site in any craft classification shall not be greater than the ratio permitted to the contractor as to the entire work force under the registered program. Any worker listed on a payroll at an apprentice wage rate, who is not registered or otherwise employed as stated above, shall be paid not less than the applicable wage rate on the wage determination for the classification of work actually performed. In addition, any apprentice performing work on the job site in excess of the ratio permitted under the registered program shall be paid not less than the applicable wage rate on the wage determination for the work actually performed. Where a contractor is performing construction on a project in a locality other than that in which its program is registered, the ratios and wage rates (expressed in percentages of the journeyman's hourly rate) specified in the contractor's or subcontractor's registered program shall be observed.

Every apprentice must be paid at not less than the rate specified in the registered program for the apprentice's level of progress, expressed as a percentage of the journeymen hourly

rate specified in the applicable wage determination. Apprentices shall be paid fringe benefits in accordance with the provisions of the apprenticeship program. If the apprenticeship program does not specify fringe benefits, apprentices must be paid the full amount of fringe benefits listed on the wage determination for the applicable classification. If the Administrator determines that a different practice prevails for the applicable apprentice classification, fringes shall be paid in accordance with that determination.

In the event the Office of Apprenticeship Training, Employer and Labor Services, or a State Apprenticeship Agency recognized by the Office, withdraws approval of an apprenticeship program, the contractor will no longer be permitted to utilize apprentices at less than the applicable predetermined rate for the work performed until an acceptable program is approved.

##### b. Trainees (programs of the USDOL).

Except as provided in 29 CFR 5.16, trainees will not be permitted to work at less than the predetermined rate for the work performed unless they are employed pursuant to and individually registered in a program which has received prior approval, evidenced by formal certification by the U.S. Department of Labor, Employment and Training Administration.

The ratio of trainees to journeymen on the job site shall not be greater than permitted under the plan approved by the Employment and Training Administration.

Every trainee must be paid at not less than the rate specified in the approved program for the trainee's level of progress, expressed as a percentage of the journeyman hourly rate specified in the applicable wage determination. Trainees shall be paid fringe benefits in accordance with the provisions of the trainee program. If the trainee program does not mention fringe benefits, trainees shall be paid the full amount of fringe benefits listed on the wage determination unless the Administrator of the Wage and Hour Division determines that there is an apprenticeship program associated with the corresponding journeyman wage rate on the wage determination which provides for less than full fringe benefits for apprentices. Any employee listed on the payroll at a trainee rate who is not registered and participating in a training plan approved by the Employment and Training Administration shall be paid not less than the applicable wage rate on the wage determination for the classification of work actually performed. In addition, any trainee performing work on the job site in excess of the ratio permitted under the registered program shall be paid not less than the applicable wage rate on the wage determination for the work actually performed.

In the event the Employment and Training Administration withdraws approval of a training program, the contractor will no longer be permitted to utilize trainees at less than the applicable predetermined rate for the work performed until an acceptable program is approved.

c. Equal employment opportunity. The utilization of apprentices, trainees and journeymen under this part shall be in conformity with the equal employment opportunity requirements of Executive Order 11246, as amended, and 29 CFR part 30.

d. Apprentices and Trainees (programs of the U.S. DOT).

Apprentices and trainees working under apprenticeship and skill training programs which have been certified by the Secretary of Transportation as promoting EEO in connection with Federal-aid highway construction programs are not subject to the requirements of paragraph 4 of this Section IV. The straight time hourly wage rates for apprentices and trainees under such programs will be established by the particular programs. The ratio of apprentices and trainees to journeymen shall not be greater than permitted by the terms of the particular program.

**5. Compliance with Copeland Act requirements.** The contractor shall comply with the requirements of 29 CFR part 3, which are incorporated by reference in this contract.

**6. Subcontracts.** The contractor or subcontractor shall insert Form FHWA-1273 in any subcontracts and also require the subcontractors to include Form FHWA-1273 in any lower tier subcontracts. The prime contractor shall be responsible for the compliance by any subcontractor or lower tier subcontractor with all the contract clauses in 29 CFR 5.5.

**7. Contract termination: debarment.** A breach of the contract clauses in 29 CFR 5.5 may be grounds for termination of the contract, and for debarment as a contractor and a subcontractor as provided in 29 CFR 5.12.

**8. Compliance with Davis-Bacon and Related Act requirements.** All rulings and interpretations of the Davis-Bacon and Related Acts contained in 29 CFR parts 1, 3, and 5 are herein incorporated by reference in this contract.

**9. Disputes concerning labor standards.** Disputes arising out of the labor standards provisions of this contract shall not be subject to the general disputes clause of this contract. Such disputes shall be resolved in accordance with the procedures of the Department of Labor set forth in 29 CFR parts 5, 6, and 7. Disputes within the meaning of this clause include disputes between the contractor (or any of its subcontractors) and the contracting agency, the U.S. Department of Labor, or the employees or their representatives.

**10. Certification of eligibility.**

a. By entering into this contract, the contractor certifies that neither it (nor he or she) nor any person or firm who has an interest in the contractor's firm is a person or firm ineligible to be awarded Government contracts by virtue of section 3(a) of the Davis-Bacon Act or 29 CFR 5.12(a)(1).

b. No part of this contract shall be subcontracted to any person or firm ineligible for award of a Government contract by virtue of section 3(a) of the Davis-Bacon Act or 29 CFR 5.12(a)(1).

c. The penalty for making false statements is prescribed in the U.S. Criminal Code, 18 U.S.C. 1001.

**V. CONTRACT WORK HOURS AND SAFETY STANDARDS ACT**

The following clauses apply to any Federal-aid construction contract in an amount in excess of \$100,000 and subject to the overtime provisions of the Contract Work Hours and Safety Standards Act. These clauses shall be inserted in addition to the clauses required by 29 CFR 5.5(a) or 29 CFR 4.6. As used in this paragraph, the terms laborers and mechanics include watchmen and guards.

**1. Overtime requirements.** No contractor or subcontractor contracting for any part of the contract work which may require or involve the employment of laborers or mechanics shall require or permit any such laborer or mechanic in any workweek in which he or she is employed on such work to work in excess of forty hours in such workweek unless such laborer or mechanic receives compensation at a rate not less than one and one-half times the basic rate of pay for all hours worked in excess of forty hours in such workweek.

**2. Violation; liability for unpaid wages; liquidated damages.** In the event of any violation of the clause set forth in paragraph (1.) of this section, the contractor and any subcontractor responsible therefor shall be liable for the unpaid wages. In addition, such contractor and subcontractor shall be liable to the United States (in the case of work done under contract for the District of Columbia or a territory, to such District or to such territory), for liquidated damages. Such liquidated damages shall be computed with respect to each individual laborer or mechanic, including watchmen and guards, employed in violation of the clause set forth in paragraph (1.) of this section, in the sum of \$10 for each calendar day on which such individual was required or permitted to work in excess of the standard workweek of forty hours without payment of the overtime wages required by the clause set forth in paragraph (1.) of this section.

**3. Withholding for unpaid wages and liquidated damages.** The FHWA or the contracting agency shall upon its own action or upon written request of an authorized representative of the Department of Labor withhold or cause to be withheld, from any moneys payable on account of work performed by the contractor or subcontractor under any such contract or any other Federal contract with the same prime contractor, or any other federally-assisted contract subject to the Contract Work Hours and Safety Standards Act, which is held by the same prime contractor, such sums as may be determined to be necessary to satisfy any liabilities of such contractor or subcontractor for unpaid wages and liquidated damages as provided in the clause set forth in paragraph (2.) of this section.

**4. Subcontracts.** The contractor or subcontractor shall insert in any subcontracts the clauses set forth in paragraph (1.) through (4.) of this section and also a clause requiring the subcontractors to include these clauses in any lower tier subcontracts. The prime contractor shall be responsible for compliance by any subcontractor or lower tier subcontractor with the clauses set forth in paragraphs (1.) through (4.) of this section.

## VI. SUBLETTING OR ASSIGNING THE CONTRACT

This provision is applicable to all Federal-aid construction contracts on the National Highway System.

1. The contractor shall perform with its own organization contract work amounting to not less than 30 percent (or a greater percentage if specified elsewhere in the contract) of the total original contract price, excluding any specialty items designated by the contracting agency. Specialty items may be performed by subcontract and the amount of any such specialty items performed may be deducted from the total original contract price before computing the amount of work required to be performed by the contractor's own organization (23 CFR 635.116).

a. The term "perform work with its own organization" refers to workers employed or leased by the prime contractor, and equipment owned or rented by the prime contractor, with or without operators. Such term does not include employees or equipment of a subcontractor or lower tier subcontractor, agents of the prime contractor, or any other assignees. The term may include payments for the costs of hiring leased employees from an employee leasing firm meeting all relevant Federal and State regulatory requirements. Leased employees may only be included in this term if the prime contractor meets all of the following conditions:

- (1) the prime contractor maintains control over the supervision of the day-to-day activities of the leased employees;
- (2) the prime contractor remains responsible for the quality of the work of the leased employees;
- (3) the prime contractor retains all power to accept or exclude individual employees from work on the project; and
- (4) the prime contractor remains ultimately responsible for the payment of predetermined minimum wages, the submission of payrolls, statements of compliance and all other Federal regulatory requirements.

b. "Specialty Items" shall be construed to be limited to work that requires highly specialized knowledge, abilities, or equipment not ordinarily available in the type of contracting organizations qualified and expected to bid or propose on the contract as a whole and in general are to be limited to minor components of the overall contract.

2. The contract amount upon which the requirements set forth in paragraph (1) of Section VI is computed includes the cost of material and manufactured products which are to be purchased or produced by the contractor under the contract provisions.

3. The contractor shall furnish (a) a competent superintendent or supervisor who is employed by the firm, has full authority to direct performance of the work in accordance with the contract requirements, and is in charge of all construction operations (regardless of who performs the work) and (b) such other of its own organizational resources (supervision, management, and engineering services) as the contracting officer determines is necessary to assure the performance of the contract.

4. No portion of the contract shall be sublet, assigned or otherwise disposed of except with the written consent of the contracting officer, or authorized representative, and such consent when given shall not be construed to relieve the contractor of any responsibility for the fulfillment of the contract. Written consent will be given only after the contracting agency has assured that each subcontract is

evidenced in writing and that it contains all pertinent provisions and requirements of the prime contract.

5. The 30% self-performance requirement of paragraph (1) is not applicable to design-build contracts; however, contracting agencies may establish their own self-performance requirements.

## VII. SAFETY: ACCIDENT PREVENTION

This provision is applicable to all Federal-aid construction contracts and to all related subcontracts.

1. In the performance of this contract the contractor shall comply with all applicable Federal, State, and local laws governing safety, health, and sanitation (23 CFR 635). The contractor shall provide all safeguards, safety devices and protective equipment and take any other needed actions as it determines, or as the contracting officer may determine, to be reasonably necessary to protect the life and health of employees on the job and the safety of the public and to protect property in connection with the performance of the work covered by the contract.

2. It is a condition of this contract, and shall be made a condition of each subcontract, which the contractor enters into pursuant to this contract, that the contractor and any subcontractor shall not permit any employee, in performance of the contract, to work in surroundings or under conditions which are unsanitary, hazardous or dangerous to his/her health or safety, as determined under construction safety and health standards (29 CFR 1926) promulgated by the Secretary of Labor, in accordance with Section 107 of the Contract Work Hours and Safety Standards Act (40 U.S.C. 3704).

3. Pursuant to 29 CFR 1926.3, it is a condition of this contract that the Secretary of Labor or authorized representative thereof, shall have right of entry to any site of contract performance to inspect or investigate the matter of compliance with the construction safety and health standards and to carry out the duties of the Secretary under Section 107 of the Contract Work Hours and Safety Standards Act (40 U.S.C.3704).

## VIII. FALSE STATEMENTS CONCERNING HIGHWAY PROJECTS

This provision is applicable to all Federal-aid construction contracts and to all related subcontracts.

In order to assure high quality and durable construction in conformity with approved plans and specifications and a high degree of reliability on statements and representations made by engineers, contractors, suppliers, and workers on Federal-aid highway projects, it is essential that all persons concerned with the project perform their functions as carefully, thoroughly, and honestly as possible. Willful falsification, distortion, or misrepresentation with respect to any facts related to the project is a violation of Federal law. To prevent any misunderstanding regarding the seriousness of these and similar acts, Form FHWA-1022 shall be posted on each Federal-aid highway project (23 CFR 635) in one or more places where it is readily available to all persons concerned with the project:

18 U.S.C. 1020 reads as follows:

"Whoever, being an officer, agent, or employee of the United States, or of any State or Territory, or whoever, whether a person, association, firm, or corporation, knowingly makes any false statement, false representation, or false report as to the character, quality, quantity, or cost of the material used or to be used, or the quantity or quality of the work performed or to be performed, or the cost thereof in connection with the submission of plans, maps, specifications, contracts, or costs of construction on any highway or related project submitted for approval to the Secretary of Transportation; or

Whoever knowingly makes any false statement, false representation, false report or false claim with respect to the character, quality, quantity, or cost of any work performed or to be performed, or materials furnished or to be furnished, in connection with the construction of any highway or related project approved by the Secretary of Transportation; or

Whoever knowingly makes any false statement or false representation as to material fact in any statement, certificate, or report submitted pursuant to provisions of the Federal-aid Roads Act approved July 1, 1916, (39 Stat. 355), as amended and supplemented;

Shall be fined under this title or imprisoned not more than 5 years or both."

#### **IX. IMPLEMENTATION OF CLEAN AIR ACT AND FEDERAL WATER POLLUTION CONTROL ACT**

This provision is applicable to all Federal-aid construction contracts and to all related subcontracts.

By submission of this bid/proposal or the execution of this contract, or subcontract, as appropriate, the bidder, proposer, Federal-aid construction contractor, or subcontractor, as appropriate, will be deemed to have stipulated as follows:

1. That any person who is or will be utilized in the performance of this contract is not prohibited from receiving an award due to a violation of Section 508 of the Clean Water Act or Section 306 of the Clean Air Act.

2. That the contractor agrees to include or cause to be included the requirements of paragraph (1) of this Section X in every subcontract, and further agrees to take such action as the contracting agency may direct as a means of enforcing such requirements.

#### **X. CERTIFICATION REGARDING DEBARMENT, SUSPENSION, INELIGIBILITY AND VOLUNTARY EXCLUSION**

This provision is applicable to all Federal-aid construction contracts, design-build contracts, subcontracts, lower-tier subcontracts, purchase orders, lease agreements, consultant contracts or any other covered transaction requiring FHWA approval or that is estimated to cost \$25,000 or more – as defined in 2 CFR Parts 180 and 1200.

##### **1. Instructions for Certification – First Tier Participants:**

a. By signing and submitting this proposal, the prospective first tier participant is providing the certification set out below.

b. The inability of a person to provide the certification set out below will not necessarily result in denial of participation in this

covered transaction. The prospective first tier participant shall submit an explanation of why it cannot provide the certification set out below. The certification or explanation will be considered in connection with the department or agency's determination whether to enter into this transaction. However, failure of the prospective first tier participant to furnish a certification or an explanation shall disqualify such a person from participation in this transaction.

c. The certification in this clause is a material representation of fact upon which reliance was placed when the contracting agency determined to enter into this transaction. If it is later determined that the prospective participant knowingly rendered an erroneous certification, in addition to other remedies available to the Federal Government, the contracting agency may terminate this transaction for cause of default.

d. The prospective first tier participant shall provide immediate written notice to the contracting agency to whom this proposal is submitted if any time the prospective first tier participant learns that its certification was erroneous when submitted or has become erroneous by reason of changed circumstances.

e. The terms "covered transaction," "debarred," "suspended," "ineligible," "participant," "person," "principal," and "voluntarily excluded," as used in this clause, are defined in 2 CFR Parts 180 and 1200. "First Tier Covered Transactions" refers to any covered transaction between a grantee or subgrantee of Federal funds and a participant (such as the prime or general contract). "Lower Tier Covered Transactions" refers to any covered transaction under a First Tier Covered Transaction (such as subcontracts). "First Tier Participant" refers to the participant who has entered into a covered transaction with a grantee or subgrantee of Federal funds (such as the prime or general contractor). "Lower Tier Participant" refers any participant who has entered into a covered transaction with a First Tier Participant or other Lower Tier Participants (such as subcontractors and suppliers).

f. The prospective first tier participant agrees by submitting this proposal that, should the proposed covered transaction be entered into, it shall not knowingly enter into any lower tier covered transaction with a person who is debarred, suspended, declared ineligible, or voluntarily excluded from participation in this covered transaction, unless authorized by the department or agency entering into this transaction.

g. The prospective first tier participant further agrees by submitting this proposal that it will include the clause titled "Certification Regarding Debarment, Suspension, Ineligibility and Voluntary Exclusion-Lower Tier Covered Transactions," provided by the department or contracting agency, entering into this covered transaction, without modification, in all lower tier covered transactions and in all solicitations for lower tier covered transactions exceeding the \$25,000 threshold.

h. A participant in a covered transaction may rely upon a certification of a prospective participant in a lower tier covered transaction that is not debarred, suspended, ineligible, or voluntarily excluded from the covered transaction, unless it knows that the certification is erroneous. A participant is responsible for ensuring that its principals are not suspended, debarred, or otherwise ineligible to participate in covered transactions. To verify the eligibility of its principals, as well as the eligibility of any lower tier prospective participants, each participant may, but is not required to, check the Excluded Parties List System website (<https://www.epls.gov/>), which is compiled by the General Services Administration.

i. Nothing contained in the foregoing shall be construed to require the establishment of a system of records in order to render in good faith the certification required by this clause. The knowledge and information of the prospective participant is not required to exceed that which is normally possessed by a prudent person in the ordinary course of business dealings.

j. Except for transactions authorized under paragraph (f) of these instructions, if a participant in a covered transaction knowingly enters into a lower tier covered transaction with a person who is suspended, debarred, ineligible, or voluntarily excluded from participation in this transaction, in addition to other remedies available to the Federal Government, the department or agency may terminate this transaction for cause or default.

\*\*\*\*\*

## 2. Certification Regarding Debarment, Suspension, Ineligibility and Voluntary Exclusion – First Tier Participants:

a. The prospective first tier participant certifies to the best of its knowledge and belief, that it and its principals:

(1) Are not presently debarred, suspended, proposed for debarment, declared ineligible, or voluntarily excluded from participating in covered transactions by any Federal department or agency;

(2) Have not within a three-year period preceding this proposal been convicted of or had a civil judgment rendered against them for commission of fraud or a criminal offense in connection with obtaining, attempting to obtain, or performing a public (Federal, State or local) transaction or contract under a public transaction; violation of Federal or State antitrust statutes or commission of embezzlement, theft, forgery, bribery, falsification or destruction of records, making false statements, or receiving stolen property;

(3) Are not presently indicted for or otherwise criminally or civilly charged by a governmental entity (Federal, State or local) with commission of any of the offenses enumerated in paragraph (a)(2) of this certification; and

(4) Have not within a three-year period preceding this application/proposal had one or more public transactions (Federal, State or local) terminated for cause or default.

b. Where the prospective participant is unable to certify to any of the statements in this certification, such prospective participant shall attach an explanation to this proposal.

## 2. Instructions for Certification - Lower Tier Participants:

(Applicable to all subcontracts, purchase orders and other lower tier transactions requiring prior FHWA approval or estimated to cost \$25,000 or more - 2 CFR Parts 180 and 1200)

a. By signing and submitting this proposal, the prospective lower tier is providing the certification set out below.

b. The certification in this clause is a material representation of fact upon which reliance was placed when this transaction was entered into. If it is later determined that the prospective lower tier participant knowingly rendered an erroneous certification, in addition to other remedies available to the Federal Government, the department, or agency with which

this transaction originated may pursue available remedies, including suspension and/or debarment.

c. The prospective lower tier participant shall provide immediate written notice to the person to which this proposal is submitted if at any time the prospective lower tier participant learns that its certification was erroneous by reason of changed circumstances.

d. The terms "covered transaction," "debarred," "suspended," "ineligible," "participant," "person," "principal," and "voluntarily excluded," as used in this clause, are defined in 2 CFR Parts 180 and 1200. You may contact the person to which this proposal is submitted for assistance in obtaining a copy of those regulations. "First Tier Covered Transactions" refers to any covered transaction between a grantee or subgrantee of Federal funds and a participant (such as the prime or general contract). "Lower Tier Covered Transactions" refers to any covered transaction under a First Tier Covered Transaction (such as subcontracts). "First Tier Participant" refers to the participant who has entered into a covered transaction with a grantee or subgrantee of Federal funds (such as the prime or general contractor). "Lower Tier Participant" refers any participant who has entered into a covered transaction with a First Tier Participant or other Lower Tier Participants (such as subcontractors and suppliers).

e. The prospective lower tier participant agrees by submitting this proposal that, should the proposed covered transaction be entered into, it shall not knowingly enter into any lower tier covered transaction with a person who is debarred, suspended, declared ineligible, or voluntarily excluded from participation in this covered transaction, unless authorized by the department or agency with which this transaction originated.

f. The prospective lower tier participant further agrees by submitting this proposal that it will include this clause titled "Certification Regarding Debarment, Suspension, Ineligibility and Voluntary Exclusion-Lower Tier Covered Transaction," without modification, in all lower tier covered transactions and in all solicitations for lower tier covered transactions exceeding the \$25,000 threshold.

g. A participant in a covered transaction may rely upon a certification of a prospective participant in a lower tier covered transaction that is not debarred, suspended, ineligible, or voluntarily excluded from the covered transaction, unless it knows that the certification is erroneous. A participant is responsible for ensuring that its principals are not suspended, debarred, or otherwise ineligible to participate in covered transactions. To verify the eligibility of its principals, as well as the eligibility of any lower tier prospective participants, each participant may, but is not required to, check the Excluded Parties List System website (<https://www.epls.gov/>), which is compiled by the General Services Administration.

h. Nothing contained in the foregoing shall be construed to require establishment of a system of records in order to render in good faith the certification required by this clause. The knowledge and information of participant is not required to exceed that which is normally possessed by a prudent person in the ordinary course of business dealings.

i. Except for transactions authorized under paragraph e of these instructions, if a participant in a covered transaction knowingly enters into a lower tier covered transaction with a person who is suspended, debarred, ineligible, or voluntarily excluded from participation in this transaction, in addition to other remedies available to the Federal Government, the

department or agency with which this transaction originated may pursue available remedies, including suspension and/or debarment.

\*\*\*\*\*

**Certification Regarding Debarment, Suspension, Ineligibility and Voluntary Exclusion--Lower Tier Participants:**

1. The prospective lower tier participant certifies, by submission of this proposal, that neither it nor its principals is presently debarred, suspended, proposed for debarment, declared ineligible, or voluntarily excluded from participating in covered transactions by any Federal department or agency.

2. Where the prospective lower tier participant is unable to certify to any of the statements in this certification, such prospective participant shall attach an explanation to this proposal.

\*\*\*\*\*

**XI. CERTIFICATION REGARDING USE OF CONTRACT FUNDS FOR LOBBYING**

This provision is applicable to all Federal-aid construction contracts and to all related subcontracts which exceed \$100,000 (49 CFR 20).

1. The prospective participant certifies, by signing and submitting this bid or proposal, to the best of his or her knowledge and belief, that:

a. No Federal appropriated funds have been paid or will be paid, by or on behalf of the undersigned, to any person for influencing or attempting to influence an officer or employee of any Federal agency, a Member of Congress, an officer or employee of Congress, or an employee of a Member of Congress in connection with the awarding of any Federal contract, the making of any Federal grant, the making of any Federal loan, the entering into of any cooperative agreement, and the extension, continuation, renewal, amendment, or modification of any Federal contract, grant, loan, or cooperative agreement.

b. If any funds other than Federal appropriated funds have been paid or will be paid to any person for influencing or attempting to influence an officer or employee of any Federal agency, a Member of Congress, an officer or employee of Congress, or an employee of a Member of Congress in connection with this Federal contract, grant, loan, or cooperative agreement, the undersigned shall complete and submit Standard Form-L.L.L., "Disclosure Form to Report Lobbying," in accordance with its instructions.

2. This certification is a material representation of fact upon which reliance was placed when this transaction was made or entered into. Submission of this certification is a prerequisite for making or entering into this transaction imposed by 31 U.S.C. 1352. Any person who fails to file the required certification shall be subject to a civil penalty of not less than \$10,000 and not more than \$100,000 for each such failure.

3. The prospective participant also agrees by submitting its bid or proposal that the participant shall require that the language of this certification be included in all lower tier subcontracts, which exceed \$100,000 and that all such recipients shall certify and disclose accordingly.

**ATTACHMENT A - EMPLOYMENT AND MATERIALS  
PREFERENCE FOR APPALACHIAN DEVELOPMENT  
HIGHWAY SYSTEM OR APPALACHIAN LOCAL ACCESS  
ROAD CONTRACTS**

This provision is applicable to all Federal-aid projects funded under the Appalachian Regional Development Act of 1965.

1. During the performance of this contract, the contractor undertaking to do work which is, or reasonably may be, done as on-site work, shall give preference to qualified persons who regularly reside in the labor area as designated by the DOL wherein the contract work is situated, or the subregion, or the Appalachian counties of the State wherein the contract work is situated, except:

a. To the extent that qualified persons regularly residing in the area are not available.

b. For the reasonable needs of the contractor to employ supervisory or specially experienced personnel necessary to assure an efficient execution of the contract work.

c. For the obligation of the contractor to offer employment to present or former employees as the result of a lawful collective bargaining contract, provided that the number of nonresident persons employed under this subparagraph (1c) shall not exceed 20 percent of the total number of employees employed by the contractor on the contract work, except as provided in subparagraph (4) below.

2. The contractor shall place a job order with the State Employment Service indicating (a) the classifications of the laborers, mechanics and other employees required to perform the contract work, (b) the number of employees required in each classification, (c) the date on which the participant estimates such employees will be required, and (d) any other pertinent information required by the State Employment Service to complete the job order form. The job order may be placed with the State Employment Service in writing or by telephone. If during the course of the contract work, the information submitted by the contractor in the original job order is substantially modified, the participant shall promptly notify the State Employment Service.

3. The contractor shall give full consideration to all qualified job applicants referred to him by the State Employment Service. The contractor is not required to grant employment to any job applicants who, in his opinion, are not qualified to perform the classification of work required.

4. If, within one week following the placing of a job order by the contractor with the State Employment Service, the State Employment Service is unable to refer any qualified job applicants to the contractor, or less than the number requested, the State Employment Service will forward a certificate to the contractor indicating the unavailability of applicants. Such certificate shall be made a part of the contractor's permanent project records. Upon receipt of this certificate, the contractor may employ persons who do not normally reside in the labor area to fill positions covered by the certificate, notwithstanding the provisions of subparagraph (1c) above.

5. The provisions of 23 CFR 633.207(e) allow the contracting agency to provide a contractual preference for the use of mineral resource materials native to the Appalachian region.

6. The contractor shall include the provisions of Sections 1 through 4 of this Attachment A in every subcontract for work which is, or reasonably may be, done as on-site work.

EXHIBIT "J"

PROPOSER'S AFFIDAVIT  
PROPOSER'S AFFAVIT OF NON-  
COLLUSION  
NON-CONFLICT OF INTEREST, AND  
LOBBING

# Exhibit "J"

## PROPOSER'S AFFIDAVIT

<b>PROPOSER'S AFFIDAVIT OF NON-COLLUSION NON-CONFLICT OF INTEREST, AND ANTI-LOBBYING</b>
--

STATE OF TEXAS  
COUNTY OF HIDALGO

Affiant, \_\_\_\_\_, being first duly sworn, deposes that:

- (1) Affiant does hereby state neither the proposer nor any of the proposer's officers, partners, owners, agents, representatives, employees, or parties in interest, has in any way colluded, conspired, agreed, directly or indirectly with any person, firm, corporation, or another proposer, or potential proposer, to provide any money or other valuable consideration for assistance in procuring or attempting to procure a contract or fix the prices in the attached proposed or the proposal of any other proposer, and further states that no such money or another reward will be hereinafter paid.
- (2) Affiant further states they have neither recommended nor suggested to Hidalgo County or any of its officials or employees, any of the terms or provisions set forth in their Request for Proposal and subsequent agreement, except at a meeting open to all interested proposers, of which proper notice was given.
- (3) Affiant, further states their officers, employees, or agents have not, and will not attempt to lobby, directly or indirectly, the Hidalgo County Commissioner's Court between proposal submission date and award by the Hidalgo County Commissioner's Court.
- (4) Affiant further states no officer, or stockholder of the proposer is a member of the staff, or related to any employee of Hidalgo County except as noted herein below:

\_\_\_\_\_  
Signature/Title: \_\_\_\_\_

Subscribed and sworn to before me this \_\_\_\_\_ day of \_\_\_\_\_, 2019.

\_\_\_\_\_  
Notary Public

My commission expires: \_\_\_\_\_, 20\_\_\_\_



**HIDALGO COUNTY**  
(Including all funding sources, programs, and entities)  
**REQUEST FOR BIDS**

**"Pipes & Related Miscellaneous Items"**

RFB No.: 2019-100-05-15-TDL

**RFB SUBMITTAL CHECKLIST**

All forms listed below must be submitted in the RFB response. If forms are not submitted, your response may be considered non-responsive.

Indicate with a check mark (✓) the Forms completed and included in this response:

- \_\_\_\_\_ Page 11 of Legal Notice
- \_\_\_\_\_ Exhibit "C" – Insurance Requirement Acknowledgement forms (pages 3 and 4)
- \_\_\_\_\_ Exhibit "D" - CIQ Form -Copy of County Clerk File Recording fee receipt (if applicable)
- \_\_\_\_\_ Exhibit "E" – Vendor/Bidder Application - W-9 Form – HUB/DBE
- \_\_\_\_\_ Exhibit "F" – Certification Regarding Debarment
- \_\_\_\_\_ Exhibit "H" – Required Contract Clauses for Contracts Under Federal Award 2 – CFR 200, Appendix II & FEMA (if applicable)
- \_\_\_\_\_ Exhibit "J" – Proposer's Affidavit
- \_\_\_\_\_ SAMS.gov Registration Acknowledgement
- \_\_\_\_\_ One (1) Original (original must be one (1) sided and clearly marked as original), one (1) Copy, and six (6) CD/USB in PDF format containing a complete copy of Response.

\_\_\_\_\_  
Signature

\_\_\_\_\_  
Date

## REQUIREMENTS AGREEMENT

C-19-100-00-00

**THIS AGREEMENT** (the "Agreement") is entered into effective as of the xxth day of MONTH, YEAR by and between VENDOR'S NAME ("Seller") and Hidalgo County, Texas ("Buyer").

**WHEREAS**, Buyer has solicited sealed bids for the supply of its requirements of **Hidalgo County** for the "**Pipes & Related Miscellaneous Items**" (the "Product") for **HIDALGO COUNTY**, as further described in Exhibit "A", Request for Bids (RFB) Procurement Packet as attached hereto and incorporated herein by reference for all purposes (the "RFB") for a period of **one (1) year** and;

**WHEREAS**, Seller has submitted a proposal to supply Buyer's requirements; and

**WHEREAS**, Buyer has determine that Seller has submitted the lowest and best bid to meet Buyer's requirements for certain of the Products, as herein after described.

**NOW THEREFORE**, for and in consideration of the mutual covenants and conditions hereinafter set forth, and other good and valuable consideration, the receipt and sufficiency of which is hereby acknowledged, the parties hereto agree as follows:

1. Buyer agrees to purchase from Seller, and Seller agrees to sell and deliver to Buyer, all of the Products listed on Exhibit "B", which is attached hereto and incorporated herein by reference, that Buyer may require for use by Buyer in Hidalgo County projects for a period of a **one (1) year** with the County's option to extend/renew for an additional one (1) year period under the same rates, terms and conditions. Hidalgo County reserves the right to continue this bid for an additional sixty (60) day grace period, under the same rates, terms and conditions at the end of the contract term for unforeseen delays in award of new bid for the next contract term. This Contract shall commence on **DATE** and expire on **DATE** and it is agreed that the Products will meet the Specifications in the Request for Bids (RFB) Procurement Packet set forth in Exhibit "A" hereto.

2. When Buyer determines that it needs a quantity of the Products to be delivered, it will, according to its Purchasing Policies, complete and submit to Seller a Purchase Order describing the type and quantity of the Products required. The Products are to be delivered by Seller to the location in Hidalgo County specified by Buyer in its Purchase Order.

3. Buyer agrees to pay Seller for each Purchase Order based on the prices set out in Exhibit "B". Seller shall render invoices for each Purchase Order, and the invoices shall be paid by Buyer on or before the 30th day following receipt of the invoice.

4. General Provisions.

a. **Conflict with Applicable Law.** Nothing in this Agreement shall be

construed so as to require the commission of any act contrary to law, and whenever there is any conflict between any provision of this Agreement and any present or future law, ordinance or administrative, executive or judicial regulation, order or decree, or amendment thereof, contrary to which the parties have no legal right to contract, the latter shall prevail, but in such event the affected provision or provisions of this Agreement shall be modified only to the extent necessary to bring them within the legal requirements and only during the time such conflict exists.

b. **No Waiver.** No waiver by Buyer of any breach of any provision of this Agreement shall be deemed to be a waiver of any preceding or succeeding breach of the same or any other provision hereof.

c. **Entire Agreement.** This Agreement contains the entire contract between the parties hereto, and each party acknowledges that neither has made (either directly or through any agent or representative) any representations or agreements in connection with this Agreement not specifically set forth herein. This Agreement may be modified or amended only by agreement in writing executed by Buyer and Seller, and not otherwise.

d. **Texas Law to Apply.** This Agreement shall be construed under and in accordance with the laws of the State of Texas, and all obligations of the parties created hereunder are performable in Hidalgo County, Texas. The parties hereby consent to personal jurisdiction in Hidalgo County, Texas.

e. **Notice.** Except as may be otherwise specifically provided in this Agreement, all notices, demands, requests or communications required or permitted hereunder shall be in writing and shall either be (i) personally delivered against a written receipt, or (ii) sent by registered or certified mail, return receipt requested, postage prepaid and addressed to the parties at the addresses set forth below, or at such other addresses as may have been theretofore specified by written notice delivered in accordance herewith:

If to Buyer:

Hidalgo County  
Attention: County Judge  
1615 South Closner, Suite J  
Edinburg, Texas 78539

If to Seller:

VENDOR'S NAME  
ADDRESS  
CITY, STATE

Each notice, demand, request or communication which shall be delivered or mailed in the manner described above shall be deemed sufficiently given for all purposes at such time as it is personally delivered to the addressee or, if mailed, at such time as it is deposited in the United States mail.

- f. **Termination.** Buyer may terminate this Agreement at any time for any reason or no reason at all upon giving thirty (30) days written notice.
- g. **Additional Documents.** The parties hereto covenant and agree that they will execute such other and further instruments and documents as are or may become necessary or convenient to effectuate and carry out the terms of this Agreement.
- h. **Successors.** This Agreement shall be binding upon and inure to the benefit of the parties hereto and their respective heirs, executors, administrators, legal representatives, successors, and assigns where permitted by this Agreement.
- i. **Assignment.** This Agreement shall not be assignable.
- j. **Headings.** The headings and captions contained in this Agreement are solely for convenient reference and shall not be deemed to affect the meaning or interpretation of any provision or paragraph hereof.
- k. **Gender and Number.** All pronouns used in this Agreement shall include the other gender, whether used in the masculine, feminine or neuter gender, and the singular shall include the plural whenever and as often as may be appropriate.
- l. **Authority to Execute.** The execution and performance of this Agreement by Buyer and Seller have been duly authorized by all necessary laws, resolutions or corporate action, and this Agreement constitutes the valid and enforceable obligations of Buyer and Seller in accordance with its terms.
- m. **Insurance.** Seller shall provide, to the extent it deems necessary, insurance in force on all persons connected with providing services under this Contract naming Buyer as an additional insured, and shall furnish to Buyer certificates of such insurance coverage Exhibit "C", which is attached hereto.
- n. **Commitment of Current Revenues Only.** In the event that, during any term hereof, the Commissioners Court of Buyer does not appropriate sufficient funds to meet the obligations of Buyer under this Agreement, Buyer may terminate this Agreement upon ninety (90) days written notice to Seller. Buyer agrees, however, to use reasonable efforts to secure funds necessary for the continued performance of this Agreement. The parties intend this provision to be a continuing right to terminate this Agreement at the expiration of each budget period of Buyer pursuant to the provisions of Tex. Loc. Govt. Code Ann. ' 271.903 (Vernon Supp. 1996).
- o. **Purchasing Ethics.** Seller represents and warrants it has not, during the process of being awarded this contract violated the following ethical standards of Buyer and, upon and after the execution of this Agreement, agrees to abide by the following ethical standards of Buyer:

- (1) It shall be a breach of ethics to offer, give or agree to give any elected official, department head or employee, or former elected official, department head or employee, of Hidalgo County, or for any elected official, department head or employee or former elected official, department head or employee of Hidalgo County, to solicit, demand, accept or agree to accept from another person, entity or organization, a gratuity or an officer of employment in connection with any decision, approval, disapproval, recommendation, preparation or any part of a program requirement or purchase request, influencing the content of any specification or procurement standard, rendering of advise, investigation, auditing, or in any other advisory capacity in any proceeding or application, request for ruling, determination, claim or controversy, or other particular matter pertaining to any program requirement or a contract or subcontract, or to any solicitation or proposal therefore pending before any department or agency of Hidalgo County.
- (2) It shall be a breach of ethics for any payment, gratuity or offer of employment to be made by or on behalf of a subcontractor under a contract to the prime contractor or higher tier subcontractor for any contract for Hidalgo County, or any person associated therewith, as an inducement for the award of a subcontract or order.

p. **Immunities.** Nothing in this Agreement is intended to and Buyer does not hereby waive, release or relinquish any right to assert any of the defenses Buyer enjoys by virtue of the state or federal constitution, laws, rules or regulations, and any sovereign, official or qualified immunity available to Buyer as to any claim or action of any person, entity, or individual against Buyer.

**EXECUTED** effective as of the day and year first above written.

**APPROVED AS TO FORM:**

Office of the Hidalgo County Criminal District Attorney

By: \_\_\_\_\_

Assistant District Attorney

**COUNTY OF HIDALGO**

By: \_\_\_\_\_

Ramon Garcia, County Judge

**ATTEST:**

\_\_\_\_\_  
Arturo Guajardo Jr., County Clerk

**COMPANY:**

By: \_\_\_\_\_

Printed Name: \_\_\_\_\_

Title: \_\_\_\_\_

**DRAFT**

**EXHIBIT "A"**

REQUEST FOR SEALED BIDS (RFB) PROCUREMENT PACKET

DRAFT

**EXHIBIT "B"**  
BID PAGE

DRAFT

**EXHIBIT "C"**  
CERTIFICATE OF INSURANCE

**DRAFT**

**EXHIBIT "B"**  
BID PAGE

**EXHIBIT "B" – BID PAGE**  
**Hidalgo County (All funding sources, programs & entities)**  
**"PIPES & Related Miscellaneous Items"**  
**RFB No.: 2019-100-05-15-TDL**

**CATEGORY (A) – PIPES**

<b>CORRUGATED POLYVINYL CHLORIDE (PVC) STORM SEWER PIPE</b>		
NIGP CODE: 665-89 Polyvinyl Chloride (PVC)		
DESCRIPTION	PRICE	
12"		LF
15"		LF
18"		LF
24"	<i>N/A</i>	LF
30"		LF
36"		LF
42"		LF
48"		LF

<b>CORRUGATED STEEL STORM SEWER PIPE</b>			
NIGP CODE: 210-29 Corrugated Galvanized Metal Pipe			
<b>(UNIT PRICE INCLUDES ONE GASKETED BAND CONNECTION FOR EVERY 20 FOOT JOINT)</b>			
DIAMETER	TYPE "IR" PIPE PRICE	TYPE "T" PIPE PRICE	TYPE "IA" PIPE PRICE
12"			LF
15"			LF
18"			LF
24"			LF
30"			LF
36"			LF
42"			LF
48"			LF
54"		<i>N/A</i>	LF
60"			LF
66"			LF
72"			LF
78"			LF
84"			LF
90"			LF
96"			LF
102"			LF
108"			LF
114"			LF
120"			LF
126"			LF
132"			LF
138"			LF
144"		LF	

**EXHIBIT "B" – BID PAGE**  
**Hidalgo County (All funding sources, programs & entities)**  
**"PIPES & Related Miscellaneous Items"**  
**RFB No.: 2019-100-05-15-TDL**

<b>REINFORCED CONCRETE PIPE – RUBBER GASKET JOINT PIPE</b>					
NIGP CODE: 658-68					
DESCRIPTION	CLASS III PRICE		CLASS IV PRICE		CLASS V PRICE
12"		LF		LF	LF
15"		LF		LF	LF
18"		LF		LF	LF
24"		LF		LF	LF
30"		LF		LF	LF
36"		LF		LF	LF
42"		LF		LF	LF
48"		LF		LF	LF
54"		LF		LF	LF
60"		LF		LF	LF
72"		LF		LF	LF

<b>REINFORCED CONCRETE PIPE – TONGUE &amp; GROOVE PIPE</b>					
NIGP CODE: 658-68					
DESCRIPTION	CLASS III PRICE		CLASS IV PRICE		CLASS V PRICE
12"		LF		LF	LF
15"		LF		LF	LF
18"		LF		LF	LF
24"		LF		LF	LF
30"		LF		LF	LF
36"		LF		LF	LF
42"		LF		LF	LF
48"		LF		LF	LF
54"		LF		LF	LF
60"		LF		LF	LF
72"		LF		LF	LF

<b>REINFORCED POLYTHYLENE PIPE – 20 FOOT JOINTS</b>		
NIGP CODE: 658-58		
DESCRIPTION	PRICE	
24"		LF
30"		LF
36"		LF
42"		LF
48"		LF
54"		LF
60"		LF
72"		LF
84"		LF
96"		LF

**EXHIBIT "B" – BID PAGE**  
**Hidalgo County (All funding sources, programs & entities)**  
**"PIPES & Related Miscellaneous Items"**  
**RFB No.: 2019-100-05-15-TDL**

<b>AWWA C900 PVC PLASTIC PRESSURE PIPE</b>					
NIGP CODE: 658-56 PLASTIC PIPES OR					
NIGP CODE: 658-60 PVC PIPES					
DESCRIPTION	DR 14 PRICE		DR 18 PRICE		DR 25 PRICE
4"		LF		LF	LF
6"		LF		LF	LF
8"		LF		LF	LF
10"		LF		LF	LF
12"		LF		LF	LF

<b>AWWA C905 PVC PLASTIC WATER PIPE</b>								
NIGP CODE: 658-56 PLASTIC PIPES OR								
NIGP CODE: 658-60 PVC PIPES								
DESCRIPTION	DR 18 PRICE		DR 25 PRICE	DR 32.5 PRICE		DR 41 PRICE		DR 51 PRICE
14"		LF	LF		LF		LF	LF
16"		LF	LF		LF		LF	LF
18"		LF	LF		LF		LF	LF
24"		LF	LF		LF		LF	LF
30"		LF	LF		LF		LF	LF
36"		LF	LF		LF		LF	LF
42"		LF	LF		LF		LF	LF
48"		LF	LF		LF		LF	LF

<b>SDR 26 AND SDR 35 GASKETED GRAVITY SANITARY SEWER PIPE</b>				
NIGP CODE: 210-35				
SEWER PIPE JOINT SEALING COMPOUND				
SIZE OF PIPE	SDR 26		SDR 35	
4"		LF		LF
6"		LF		LF
8"		LF		LF
10"		LF		LF
12"		LF		LF
15"		LF		LF

<b>HIGH PERFORMANCE (HP) POLYPROPYLENE STORM PIPE</b>		
DESCRIPTION	PRICE	
12"	\$ 7.10	LF
15"	\$ 8.88	LF
18"	\$ 11.71	LF
24"	\$ 19.74	LF
30"	\$ 30.72	LF
36"	\$ 33.66	LF
42"	\$ 43.22	LF
48"	\$ 56.65	LF
60"	\$ 88.80	LF

**EXHIBIT "B" – BID PAGE**  
**Hidalgo County (All funding sources, programs & entities)**  
**"PIPES & Related Miscellaneous Items"**  
**RFB No.: 2019-100-05-15-TDL**

<b>HIGH DESTINY POLYETHYLENE PIPE (HDPE)</b>		
NIGP CODE: 658-58 Polyethylene Pipe And Fitting		
DESCRIPTION	PRICE	
4"	\$ .73	LF
6"	\$ 1.58	LF
8"	\$ 3.31	LF
10"	\$ 5.10	LF
12"	\$ 5.23	LF
15"	\$ 7.98	LF
18"	\$ 10.85	LF
24"	\$ 16.83	LF
30"	\$ 25.95	LF
36"	\$ 32.64	LF
42"	\$ 45.41	LF
48"	\$ 51.46	LF
54"	MA	LF
60"	\$ 87.06	LF

<b>PLUMBING PIPES – 20 FOOT SECTIONS</b>	
NIGP CODE: 967-60	
PVC	PRICE
1/2"	
1 1/2"	
2"	
3"	
4"	

<b>PLUMBING PIPES – 20 FOOT SECTIONS</b>	
NIGP CODE: 967-60	
COPPER	PRICE
1/2"	
3/4"	

**EXHIBIT "B" - BID PAGE**  
**Hidalgo County (All funding sources, programs & entities)**  
**"PIPES & Related Miscellaneous Items"**  
**RFB No.: 2019-100-05-15-TDL**

**CATEGORY (B) - INLETS**

NIGP CODE: 210-31

**INLETS, AREA, SEWER DRAIN, PRECAST, CONCRETE, STORM DRAIN, NO BOTTOM FLOORS**

DESCRIPTION	PRICE																	
	2'	2 1/2'	3'	3 1/2'	4'	4 1/2'	5'	5 1/2'	6'	6 1/2'	7'	7 1/2'	8'	8 1/2'	9'	9 1/2'	10'	
Type "A" Inlet (5' x 3')																		
Type "A-1" Inlet (5' x 4')																		
Type "A-2" Inlet (5' x 5')																		
Type "A-3" Inlet (5' x 6')																		
Type "A" (SPL-1) Inlet (5' x 3')																		
Type "A-1" (SPL-1) Inlet (5' x 4')																		
Type "A-2" (SPL-1) Inlet (5' x 5')																		
Type "A-3" (SPL-1) Inlet (5' x 6')																		
TYPE "C" INLET 2' X 2'																		
TYPE "C" INLET 3' X 3'																		
TYPE "C" INLET 4' X 4'																		
TYPE "CC" INLET 5' X 3'																		

*N/A*



**EXHIBIT "B" – BID PAGE**  
**Hidalgo County (All funding sources, programs & entities)**  
**"PIPES & Related Miscellaneous Items"**  
**RFB No.: 2019-100-05-15-TDL**

**CATEGORY (D) – MISCELLANEOUS**

DESCRIPTION		
WATER VALVE	UNIT	PRICE
2"	EA	
4"	EA	
6"	EA	
8"	EA	
10"	EA	
<b>90 DEGREE ELBOW</b>		
2"	EA	
4"	EA	
6"	EA	
8"	EA	
10"	EA	
<b>45 DEGREE ELBOW</b>		
2"	EA	
4"	EA	
6"	EA	
8"	EA	
10"	EA	
<b>STEEL PIPE CASING WITH SPACERS</b>		
4"	LF	
6"	LF	
12"	LF	
16"	LF	
24"	LF	
<b>FIRE HYDRANT W/VALVE</b>		
	EA	
<b>PVC SCHEDULE 40 WATER LINE DR 18</b>		
2"	LF	
8"	LF	
<b>PVC SCHEDULE 40</b>		
1.5"	LF	
0.75"	LF	
0.5"	LF	
<b>WATER SADDLE W/2' CORPORATE VALVE</b>		
8" x 2"	EA	

**EXHIBIT "B" - BID PAGE**  
**Hidalgo County (All funding sources, programs & entities)**  
**"PIPES & Related Miscellaneous Items"**  
**RFB No.: 2019-100-05-15-TDL**

<b>HP Dual Wall Marmac Couplers</b>		
<b>PIPE SIZE</b>	<b>PRICE</b>	<b>UNIT</b>
12"	\$ 48.61	EA
15"	\$ 55.10	EA
18"	\$ 67.76	EA
24"	\$ 87.70	EA
30"	\$ 113.39	EA
36"	\$ 132.68	EA
42"	\$ 147.73	EA
48"	\$ 288.73	EA
60"	\$ 323.88	EA

<b>HP Dual Wall Fabricated Tees</b>		
<b>PIPE SIZE</b>	<b>PRICE</b>	<b>UNIT</b>
12"	\$ 325.37	EA
15"	\$ 417.09	EA
18"	\$ 525.47	EA
24"	\$ 784.71	EA
30"	\$ 1312.32	EA
36"	\$ 1728.97	EA
42"	\$ 1949.78	EA
48"	\$ 2672.32	EA
60"	\$ 4287.08	EA

<b>HP Dual Wall Fabricated Bends</b>						
<b>PIPE SIZE</b>	<b>11.25 Bend</b>	<b>22.5 Bend</b>	<b>30* Bend</b>	<b>45* Bend</b>	<b>90* Bend</b>	<b>Unit</b>
12"	\$ 149.84	\$ 159.01	\$ 161.13	\$ 161.86	\$ 171.90	EA
15"	\$ 193.03	\$ 203.89	\$ 207.12	\$ 462.13	\$ 227.13	EA
18"	\$ 217.49	\$ 248.78	\$ 244.91	\$ 253.51	\$ 295.26	EA
24"	\$ 337.86	\$ 400.11	\$ 377.21	\$ 406.72	\$ 457.81	EA
30"	\$ 520.08	\$ 547.02	\$ 579.72	\$ 603.24	\$ 738.44	EA
36"	\$ 637.47	\$ 717.46	\$ 813.77	\$ 777.44	\$ 941.01	EA
42"	\$ 790.39	\$ 948.94	\$ 980.58	\$ 1007.26	\$ 1210.83	EA
48"	\$ 968.27	\$ 1187.83	\$ 1229.34	\$ 1253.27	\$ 1318.89	EA
60"	\$ 1438.88	\$ 2022.97	\$ 1865.99	\$ 2116.19	\$ 2447.98	EA

EXHIBIT "B" - BID PAGE  
Hidalgo County (All funding sources, programs & entities)  
"PIPES & Related Miscellaneous Items"  
RFB No.: 2019-100-05-15-TDL

---

BIDDER/COMPANY NAME: Jorge Zavala / ACT Pipe & Supply  
ADDRESS: 1004 N. Shary Rd  
CITY: Mission STATE: Tx ZIPCODE: 78572  
PHONE No: (956) 583-1558 FAX No: (956) 580-4987 CELL No: (956) 463-5889  
AUTHORIZED SIGNATURE:   
PRINTED NAME: Jorge Zavala  
TITLE: Ops Manager / Sales DATE: 5/14/19  
EMAIL: jzavala @ actpipe .com

**TABULATION SHEET**  
**Hidalgo County (All funding sources, programs & entities)**  
**“PIPES & Related Miscellaneous Items”**  
**RFB No.: 2019-100-05-15-TDL**

---

<b>HIGH DESTINY POLYETHYLENE PIPE (HDPE)</b>	
NIGP CODE: 658-58 Polyethylene Pipe And Fitting	
VENDORS	Act Pipe and Supply
4”LF	.73
6”LF	1.58
15”LF	7.98

**EXHIBIT "C"**  
CERTIFICATE OF INSURANCE



# CERTIFICATE OF LIABILITY INSURANCE

DATE (MM/DD/YYYY)  
01/25/2019

THIS CERTIFICATE IS ISSUED AS A MATTER OF INFORMATION ONLY AND CONFERS NO RIGHTS UPON THE CERTIFICATE HOLDER. THIS CERTIFICATE DOES NOT AFFIRMATIVELY OR NEGATIVELY AMEND, EXTEND OR ALTER THE COVERAGE AFFORDED BY THE POLICIES BELOW. THIS CERTIFICATE OF INSURANCE DOES NOT CONSTITUTE A CONTRACT BETWEEN THE ISSUING INSURER(S), AUTHORIZED REPRESENTATIVE OR PRODUCER, AND THE CERTIFICATE HOLDER.

**IMPORTANT:** If the certificate holder is an ADDITIONAL INSURED, the policy(ies) must have ADDITIONAL INSURED provisions or be endorsed. If SUBROGATION IS WAIVED, subject to the terms and conditions of the policy, certain policies may require an endorsement. A statement on this certificate does not confer rights to the certificate holder in lieu of such endorsement(s).

<b>PRODUCER</b> Marsh USA Inc. 500 Dallas Street, Suite 1500 Houston, TX 77002  CN101290171-ACT-GAWX-18-19	<b>CONTACT NAME:</b> _____	
	<b>PHONE (A/C, No, Ext):</b> _____	<b>FAX (A/C, No):</b> _____
<b>E-MAIL ADDRESS:</b> _____		
<b>INSURER(S) AFFORDING COVERAGE</b>		<b>NAIC #</b>
<b>INSURER A :</b> American Guarantee and Liability Insurance Company		26247
<b>INSURER B :</b> Zurich American Insurance Company		16535
<b>INSURER C :</b> N/A		N/A
<b>INSURER D :</b>		
<b>INSURER E :</b>		
<b>INSURER F :</b>		

**COVERAGES**      **CERTIFICATE NUMBER:** HOU-003476625-01      **REVISION NUMBER:** 2

THIS IS TO CERTIFY THAT THE POLICIES OF INSURANCE LISTED BELOW HAVE BEEN ISSUED TO THE INSURED NAMED ABOVE FOR THE POLICY PERIOD INDICATED. NOTWITHSTANDING ANY REQUIREMENT, TERM OR CONDITION OF ANY CONTRACT OR OTHER DOCUMENT WITH RESPECT TO WHICH THIS CERTIFICATE MAY BE ISSUED OR MAY PERTAIN, THE INSURANCE AFFORDED BY THE POLICIES DESCRIBED HEREIN IS SUBJECT TO ALL THE TERMS, EXCLUSIONS AND CONDITIONS OF SUCH POLICIES. LIMITS SHOWN MAY HAVE BEEN REDUCED BY PAID CLAIMS.

INSR LTR	TYPE OF INSURANCE	ADDL INSD	SUBR WVD	POLICY NUMBER	POLICY EFF (MM/DD/YYYY)	POLICY EXP (MM/DD/YYYY)	LIMITS
A	<b>COMMERCIAL GENERAL LIABILITY</b> <input type="checkbox"/> CLAIMS-MADE <input checked="" type="checkbox"/> OCCUR  GEN'L AGGREGATE LIMIT APPLIES PER: <input checked="" type="checkbox"/> POLICY <input type="checkbox"/> PRO-JECT <input type="checkbox"/> LOC OTHER: _____			CPO107145401	10/01/2018	10/01/2019	EACH OCCURRENCE \$ 1,000,000 DAMAGE TO RENTED PREMISES (Ea occurrence) \$ 1,000,000 MED EXP (Any one person) \$ 1,000 PERSONAL & ADV INJURY \$ 1,000,000 GENERAL AGGREGATE \$ 2,000,000 PRODUCTS - COMP/OP AGG \$ 2,000,000 \$
B	<b>AUTOMOBILE LIABILITY</b> <input checked="" type="checkbox"/> ANY AUTO <input type="checkbox"/> OWNED AUTOS ONLY <input type="checkbox"/> SCHEDULED AUTOS <input type="checkbox"/> HIRED AUTOS ONLY <input type="checkbox"/> NON-OWNED AUTOS ONLY			CPO107145401	10/01/2018	10/01/2019	COMBINED SINGLE LIMIT (Ea accident) \$ 1,000,000 BODILY INJURY (Per person) \$ BODILY INJURY (Per accident) \$ PROPERTY DAMAGE (Per accident) \$ \$
	<b>UMBRELLA LIAB</b> <input type="checkbox"/> OCCUR <b>EXCESS LIAB</b> <input type="checkbox"/> CLAIMS-MADE DED    RETENTION \$						EACH OCCURRENCE \$ AGGREGATE \$ \$
B	<b>WORKERS COMPENSATION AND EMPLOYERS' LIABILITY</b> ANY PROPRIETOR/PARTNER/EXECUTIVE OFFICER/MEMBER EXCLUDED? (Mandatory in NH) If yes, describe under DESCRIPTION OF OPERATIONS below	Y/N	N/A	WC028947801	10/01/2018	10/01/2019	<input checked="" type="checkbox"/> PER STATUTE <input type="checkbox"/> OTH-ER E.L. EACH ACCIDENT \$ 1,000,000 E.L. DISEASE - EA EMPLOYEE \$ 1,000,000 E.L. DISEASE - POLICY LIMIT \$ 1,000,000

DESCRIPTION OF OPERATIONS / LOCATIONS / VEHICLES (ACORD 101, Additional Remarks Schedule, may be attached if more space is required)

<b>CERTIFICATE HOLDER</b> Hidalgo County Purchasing Office 2812 S. Business Highway 281 Edinburg, TX 78539	<b>CANCELLATION</b> SHOULD ANY OF THE ABOVE DESCRIBED POLICIES BE CANCELLED BEFORE THE EXPIRATION DATE THEREOF, NOTICE WILL BE DELIVERED IN ACCORDANCE WITH THE POLICY PROVISIONS.  AUTHORIZED REPRESENTATIVE of Marsh USA Inc. John Shahidi
---	---

© 1988-2016 ACORD CORPORATION. All rights reserved.

# CERTIFICATE OF INTERESTED PARTIES

FORM 1295

1 of 1

Complete Nos. 1 - 4 and 6 if there are interested parties.  
 Complete Nos. 1, 2, 3, 5, and 6 if there are no interested parties.

## OFFICE USE ONLY CERTIFICATION OF FILING

**1 Name of business entity filing form, and the city, state and country of the business entity's place of business.**

ACT Pipe & Supply, Inc  
 Mission, TX United States

Certificate Number:  
 2019-494368

Date Filed:  
 05/22/2019

Date Acknowledged:

**2 Name of governmental entity or state agency that is a party to the contract for which the form is being filed.**

Hidalgo County

**3 Provide the identification number used by the governmental entity or state agency to track or identify the contract, and provide a description of the services, goods, or other property to be provided under the contract.**

RFB No.: 2019-100-05-15-TDL  
 "Pipes & Related Miscellaneous Items"

4	Name of Interested Party	City, State, Country (place of business)	Nature of interest (check applicable)	
			Controlling	Intermediary

5 Check only if there is NO Interested Party.

**6 UNSWORN DECLARATION**

My name is Jorge Zavala, and my date of birth is 2/20/80.

My address is 1004 W. Shary Rd (street), Mission (city), Tx (state), 78572 (zip code), USA (country).

I declare under penalty of perjury that the foregoing is true and correct.

Executed in Hidalgo County, State of Texas, on the 22 day of May, 20 19.  
 (month) (year)

  
 \_\_\_\_\_  
 Signature of authorized agent of contracting business entity  
 (Declarant)

# CERTIFICATE OF INTERESTED PARTIES

FORM 1295

1 of 1

Complete Nos. 1 - 4 and 6 if there are interested parties.  
 Complete Nos. 1, 2, 3, 5, and 6 if there are no interested parties.

## OFFICE USE ONLY CERTIFICATION OF FILING

Certificate Number:  
 2019-494368

Date Filed:  
 05/22/2019

Date Acknowledged:  
 05/22/2019

**1 Name of business entity filing form, and the city, state and country of the business entity's place of business.**  
 ACT Pipe & Supply, Inc  
 Mission, TX United States

**2 Name of governmental entity or state agency that is a party to the contract for which the form is being filed.**  
 Hidalgo County

**3 Provide the identification number used by the governmental entity or state agency to track or identify the contract, and provide a description of the services, goods, or other property to be provided under the contract.**  
 RFB No.: 2019-100-05-15-TDL  
 "Pipes & Related Miscellaneous Items"

4	Name of Interested Party	City, State, Country (place of business)	Nature of interest (check applicable)	
			Controlling	Intermediary

**5 Check only if there is NO Interested Party.**

**6 UNSWORN DECLARATION**

My name is \_\_\_\_\_, and my date of birth is \_\_\_\_\_.

My address is \_\_\_\_\_, \_\_\_\_\_, \_\_\_\_\_, \_\_\_\_\_, \_\_\_\_\_.  
(street) (city) (state) (zip code) (country)

I declare under penalty of perjury that the foregoing is true and correct.

Executed in \_\_\_\_\_ County, State of \_\_\_\_\_, on the \_\_\_\_\_ day of \_\_\_\_\_, 20\_\_\_\_.  
(month) (year)

\_\_\_\_\_  
 Signature of authorized agent of contracting business entity  
 (Declarant)

Emergency Management Agency (FEMA) are also required to contain additional contract clauses. The applicable required contract clauses were provided as part of the initial procurement packet and are incorporated herein and made part of this agreement for all purposes.

**EXECUTED** effective as of the day and year first above written.

COUNTY OF HIDALGO

BY: Richard F. Cortez  
Richard F. Cortez

**ATTEST:**

\_\_\_\_\_  
Arturo Guajardo Jr., County Clerk

APPROVED BY  
COMMISSIONERS' COURT  
ON: 6/18/19 me

COMPANY: **Act Pipe & Supply**

BY: Jorge Zavala  
Printed Name: Jorge Zavala  
Title: Ops Manager / sales

APPROVED AS TO FORM:  
Office of the Hidalgo County Criminal District Attorney

BY: Robert Viña, III  
Robert Viña, III, Assistant District Attorney  
Civil Litigation Division