

C-20-508-08-18

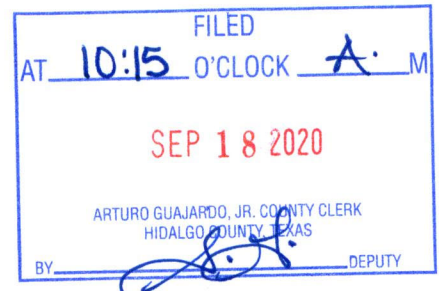

COUNTY OF HIDALGO, §
STATE OF TEXAS §

**CARES ACT INTERLOCAL COOPERATION AGREEMENT BETWEEN
THE COUNTY OF HIDALGO, TEXAS, AND THE
LA JOYA INDEPENDENT SCHOOL DISTRICT**

THIS Agreement is made on and entered into effective as of the ____ day of _____, 2020, by and between **COUNTY OF HIDALGO, TEXAS**, hereinafter referred to as ("County"), and **LA JOYA INDEPENDENT SCHOOL DISTRICT** hereinafter referred to as ("District"), collectively referred to as "Parties" and pursuant to the provisions of the Texas Interlocal Cooperation Act ("Act"), Chapter 791, et seq., Texas Government Code, as follows:

WITNESSETH:

WHEREAS, the District is organized as an Independent School District under the laws of the State of Texas for the purpose of educating and providing other activities with assist and benefit the youth and general community within its district boundary, and within the boundary of Hidalgo County; and

WHEREAS, the County is defined as a "Local Government" under the Interlocal Cooperation Act, a political subdivision organized under the laws of the State of Texas; and

WHEREAS, the County and District and their respective constituents have been affected by the COVID-19/Coronavirus public health emergency and the resulting Federal, State and Local disaster declarations and executive orders regarding the same; and

WHEREAS, the County, pursuant to its statutory and constitutional authority, are responsible for the safety and well being of the citizens; the District pursuant to its statutory authority, is responsible for the safety and well-being of its students, employee, faculty and administration, and both are desirous that necessary services and equipment are available to respond and mitigate the public health emergency; and

WHEREAS, the County and the District are authorized to enter into this Agreement pursuant to the Act, which authorizes local governments to contract with each other and with agencies of the state, to perform governmental functions and services under the terms of the Interlocal Cooperation Act; and

WHEREAS, in an effort to facilitate compliance with current public health measures related to the COVID-19 public health emergency, the County established the Hidalgo County Public Access Wi-Fi 2020 Project (hereinafter "Project") to assist the citizens of the County with

distance learning, including technological improvements, as well as improving telework capability, in connection with school and business closings; and

WHEREAS, in response to the COVID-19 pandemic public health emergency, County, in cooperation with District, has identified and is working toward developing innovative learning strategies that include access to a Public Internet Wi-Fi network as part of the Project. The Project goal is to provide free internet access to identified areas within each District and County that will enable online distance learning as well as improving telework capabilities for families that do not have the means to provide internet access. The system will be designed to support wireless devices, including laptops, iPads, and other personal devices used to access online classes and telework capabilities.

WHEREAS, County and District desire to enter into this agreement for a public purpose and for the benefit of the residents of County and District in that access to online learning will assist in mitigating the spread of COVID-19 in classrooms and schools, protecting our children, our teachers, and all school staff and to further detail each party's duties and responsibilities; and

NOW THEREFORE, County and District in consideration of the mutual covenants expressed hereinafter, agree as follows:

I. PROVISIONS OF SERVICES

Through this Agreement the **PARTIES** will develop a cooperative program to provide services as follows:

Purpose of Agreement:

1. The purpose of this agreement is to establish cooperation between the County and District on an "as needed basis" in order to coordinate the County's ongoing efforts and use of all available resources for the Public Internet Access Wi-Fi Network Project in an effort to facilitate compliance with current public health measures related to the COVID-19 public health emergency.

The participation of DISTRICT in this initiative shall consist of the following:

1. In an effort to assist the citizens of the County and District with distance learning, including technological improvements, as well as improving telework capability, in connection with school and business closings, District will provide County with access to District premises for the sole purposes of placing 4 devices on District property. Requests will be made in writing by County to District prior to the placement of any devices needed to facilitate the Public Internet Access Wi-Fi Project and thereafter, will only be placed on District property with consent and approval of District.
2. District will communicate directly with the County's designated point of contact to facilitate specific, written requests for assistance from the District for the County's efforts to provide a Public Internet Access Wi-Fi in order to provide educational information and distance learning resources to its constituents aimed at mitigating the spread of COVID-19.

The participation of COUNTY in this initiative shall consist of the following:

1. County will designate a point of contact to streamline communications between the District and County and all Elected Offices and Departments.
2. County will acquire the services of a vendor to design and implement a Public Internet Access Wi-Fi Network in order to provide educational information and distance learning resources to its constituents aimed at mitigating the spread of COVID-19.
3. County will acquire necessary equipment, hardware and software for the Public Internet Access Wi-Fi Network Project. Equipment will be installed on District premises on an as needed basis in the mutually agreed upon selected areas of each County Precinct.
4. County shall obtain District's prior written consent to coordinate access to District's premises, or should any alterations, additions, or improvements be needed to assist with the County's efforts to provide a Public Internet Access Wi-Fi Project.

5. County shall be responsible for installation, repairs and maintenance in connection with equipment and/or assets on District Premises utilized for the purpose of assisting the County with efforts to provide a Public Internet Access Wi-Fi Project.
6. County shall be responsible for costs associated with the repair and maintenance of equipment and/or County assets placed on District Premises utilized for the purpose of assisting the County with its efforts to provide a Public Internet Access Wi-Fi Project.

II. TERM OR AGREEMENT

The term of this agreement is for the lifetime of the Public Internet Access Wi-Fi Network; it will begin on **August 18, 2020**, and extend until terminated by either party or mutual agreement of the PARTIES. Upon termination, alterations, additions, or improvements made by County shall become the property of District, unless District requests removal of the same. County shall repair any damage to District Premises caused by such removal.

III. COMPENSATION

County will receive no reimbursement from District for any services provided under the agreement. Requests for financial assistance presented by District will be considered, reviewed and subsequently approved to the extent they meet the requirements of the CARES Act Guidance in that they are directly related to the County's efforts to mitigate the spread of COVID-19.

IV. NOTICES

All notices or other writing required under this Agreement shall be deemed to have been made when sent by mail to the following address:

**TO: LA JOYA INDEPENDENT
SCHOOL DISTRICT**

Attn: Gisela Saenz.
La Joya ISD Superintendent of Schools

TO COUNTY:
County of Hidalgo
Attn: Richard Cortez, County Judge
100 E. Cano
Edinburg, TX 78539



With CC to:
Daniel Salinas
Hidalgo County Director of
Information Technology
daniel.salinas@co.hidalgo.tx.us

VI. TERMINATION

This Agreement may be amended, modified or terminated by agreement of the **PARTIES**. Further, the agreement may be terminated by either party by giving thirty (30) days written notice via certified mail, return receipt requested to the other party hereto of the intention to terminate.

VII. LAW GOVERNING VENUE

This Agreement shall be governed by and construed in accordance with the laws of the State of Texas, and, obligations and undertakings of each of the **PARTIES** to this Agreement shall be performable in Hidalgo County, Texas.

VIII. LIABILITIES

This Agreement is not intended to extend the liability of the **PARTIES** beyond that provided by law. Neither party waives, nor shall be deemed to have hereby waived, any immunity or defenses that would otherwise be available to it against claims arising from third parties.

IX. ADDITIONAL DOCUMENTS

The parties hereto covenant and agree that they will execute such other and further instruments and documents as are or may become necessary or convenient to effectuate and carry out the terms of this Agreement.

X. GOVERNMENTAL PURPOSE

Each party hereto is entering into this agreement for the purpose of providing for governmental services or functions and will pay for such services out of current revenues available to the paying party as herein provided.

XI. APPENDIX II TO CFR 200-CONTRACT PROVISIONS

Pursuant to 2 CFR 200.236, a non-Federal entity's contracts must contain the applicable provisions described in Appendix II to 2 CFR 200-Contract Provisions for non-Federal Entity Contracts under Federal Awards. Therefore, if applicable, the provisions of Appendix II to 2 CFR 200 are attached and incorporated by reference into this County contract should it be subject to Federal award.

XII. NON-DISCRIMINATION

The Agreement and all related activities shall be conducted in a manner that does not discriminate against any person on a basis prohibited by applicable law or County and District policy, including without limitation race, color, national origin, religion, sex, age, veteran status, or disability.

WITNESS THE HANDS OF THE PARTIES effective as of August 18, 2020

DISTRICT

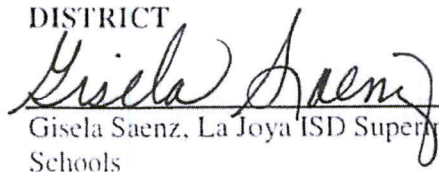

Gisela Saenz, La Joya ISD Superintendent of Schools

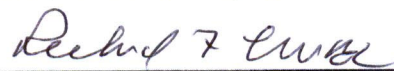
HIDALGO COUNTY, TEXAS

Richard Cortez, Hidalgo County Judge

APPROVED BY
COMMISSIONERS' COURT
ON: 8/18/20 

ATTEST:



Arturo Guajardo, Jr. Hidalgo County Clerk



APPROVED AS TO FORM:
Office of Criminal District Attorney
Ricardo Rodriguez, Jr.

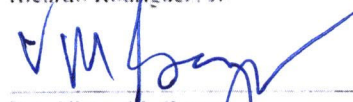

By: Victor M. Garza
Assistant District Attorney

Hidalgo County Wifi Project Precinct 3



Prepared by:

Hidalgo County Information Technology Department

August 20, 2020

Confidentiality Notice: Neither this document nor any of the information contained herein may be reproduced or disclosed under any circumstances without the express written permission of Hidalgo County. Please be aware that disclosure, copying, distribution or use of this document and the information contained therein is strictly prohibited.

Precinct 3 Area - Zone 1

No. of Students: 762 La Joya ISD

Sq. Miles: 1.1

Location: Sullivan City





HIDALGO COUNTY

Information Technology

Proposed Tower Location 1

Location: Aqua SUD Water Tower
El Pinto Rd, Sullivan City



Proposed Tower Location 2

Location: Sullivan City WIC - Hidalgo County
371 W Expy 83,
Sullivan City, TX 78595

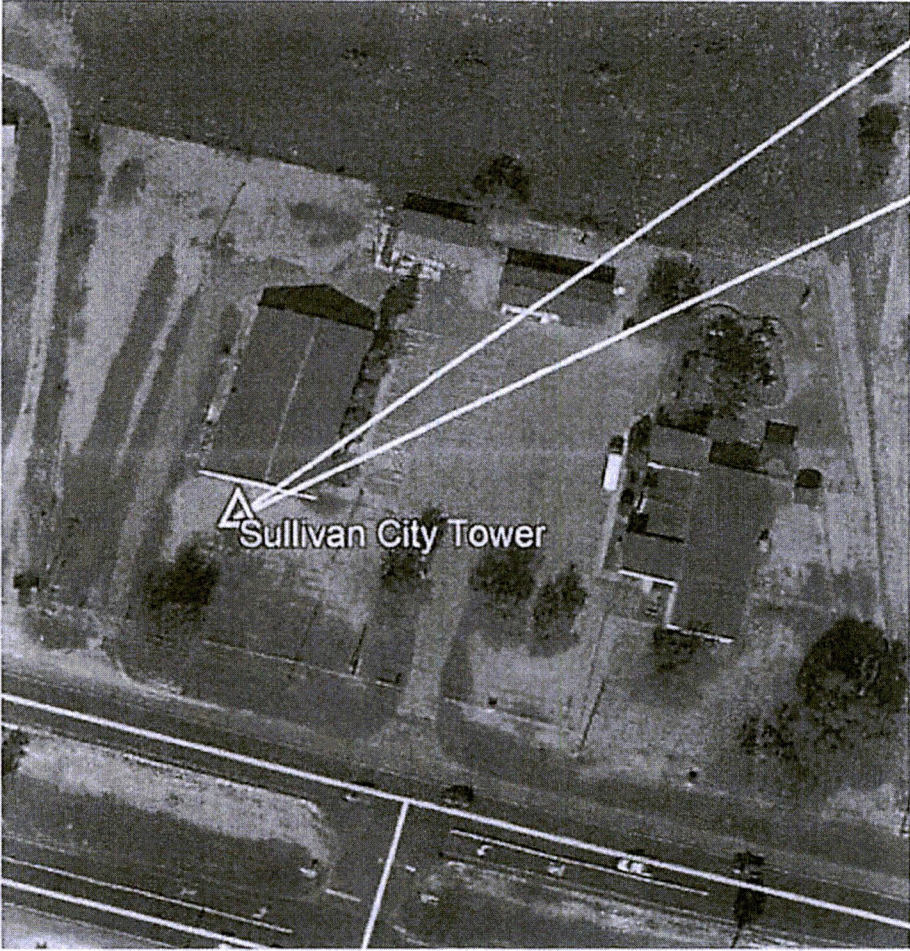

Precinct 3 Area - Zone 2

No. of Students: 1586 La Joya ISD

Sq. Miles: 1.47

Location: Mile 7 Rd

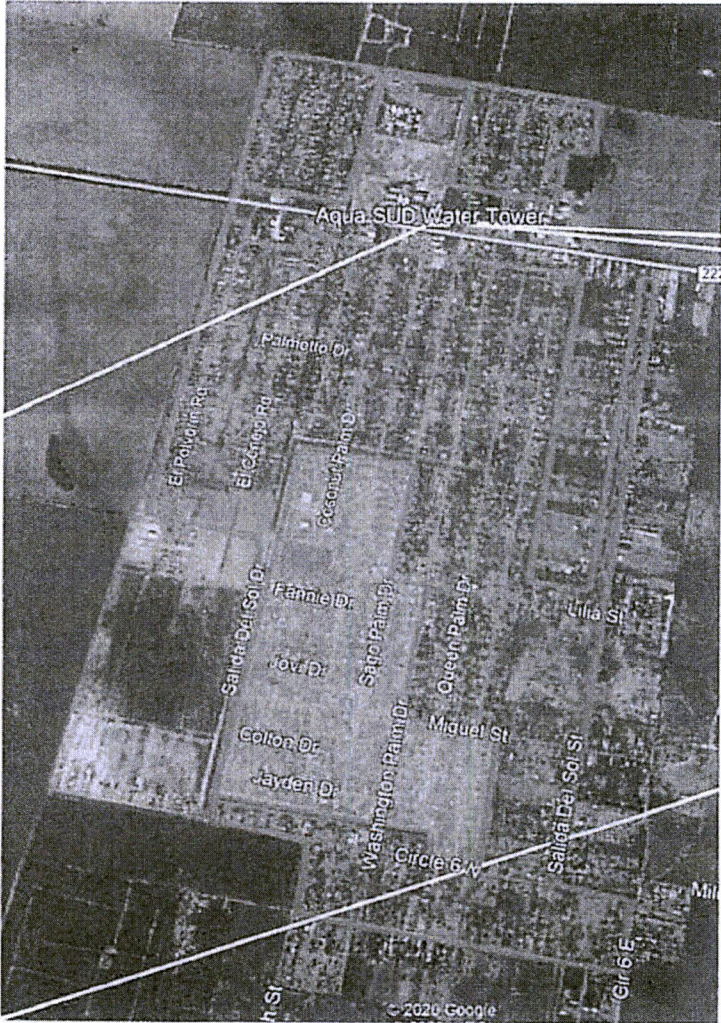



HIDALGO COUNTY

Information Technology

Proposed Tower Location

Location: Aqua SUD Water Tower
Mile 7 Rd and Sabal Palm Dr

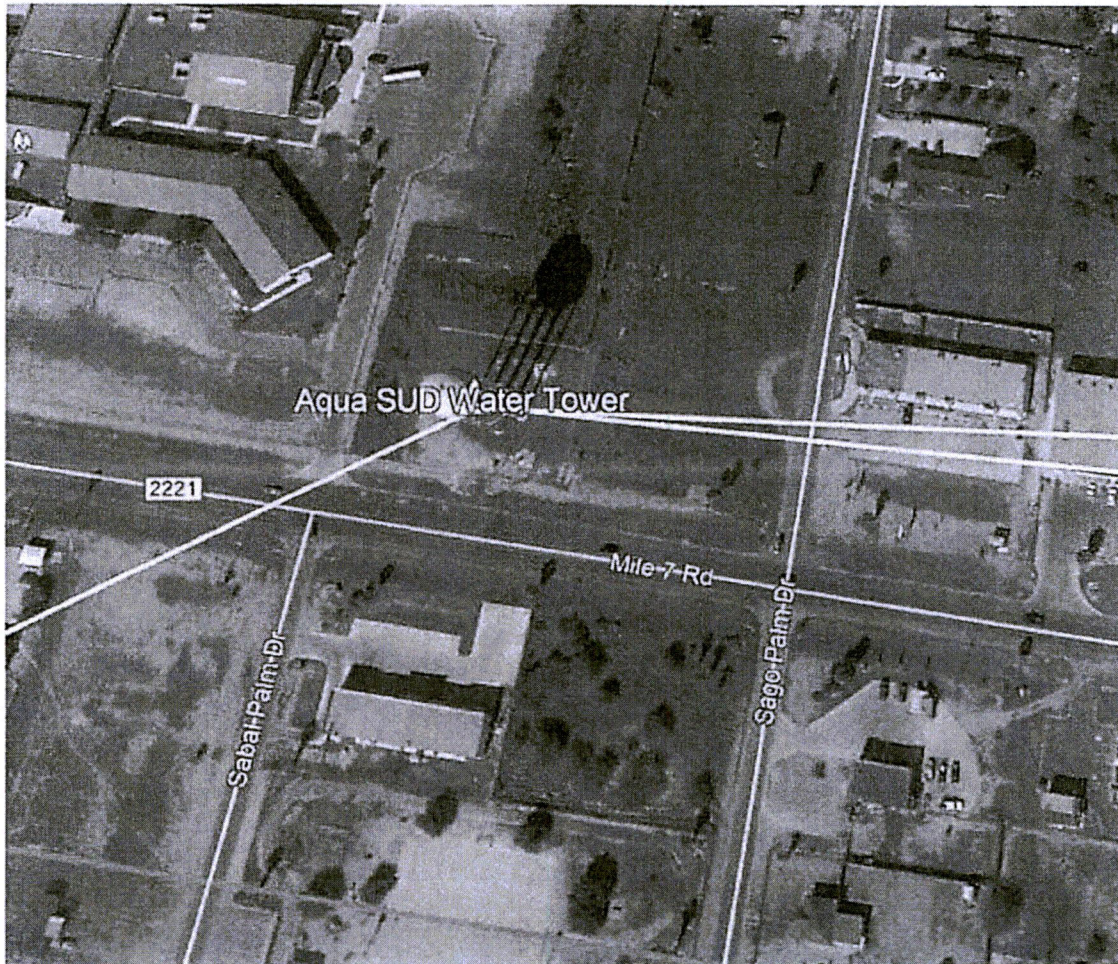



Precinct 3 Area - Zone 3

No. of Students: 421 La Joya ISD

Sq. Miles: 0.49

Location: W. Mile 7 Rd. and Western Rd.



Proposed Tower Location

Location: Seguin Elementary School - La Joya ISD
8500 Western Rd
Mission, TX 78574

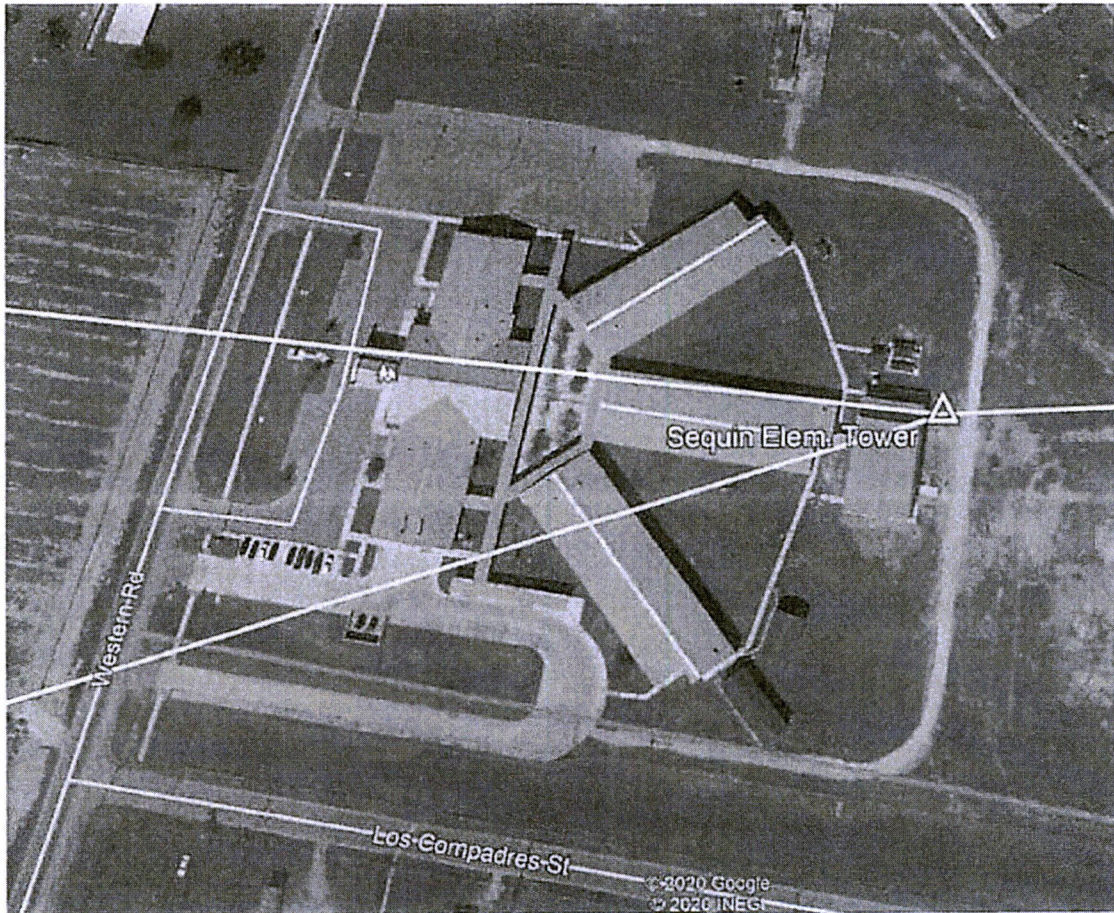



Precinct 3 Area - Zone 4

No. of Students: 755 La Joya ISD

Sq. Miles: 0.64

Location: W. Mile 7 Rd. and La Homa Rd.

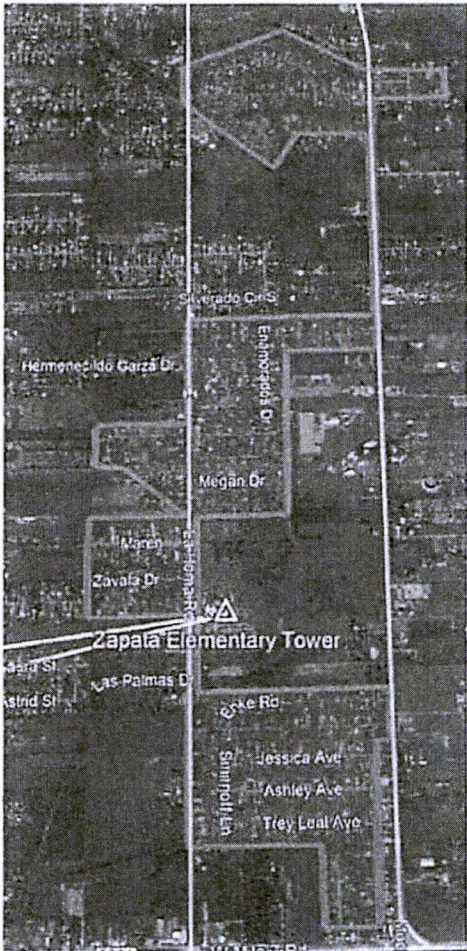



Proposed Tower Location

Location: Emiliano Zapata Elementary School - La Joya ISD
9100 La Homa Rd
Mission, TX 78574

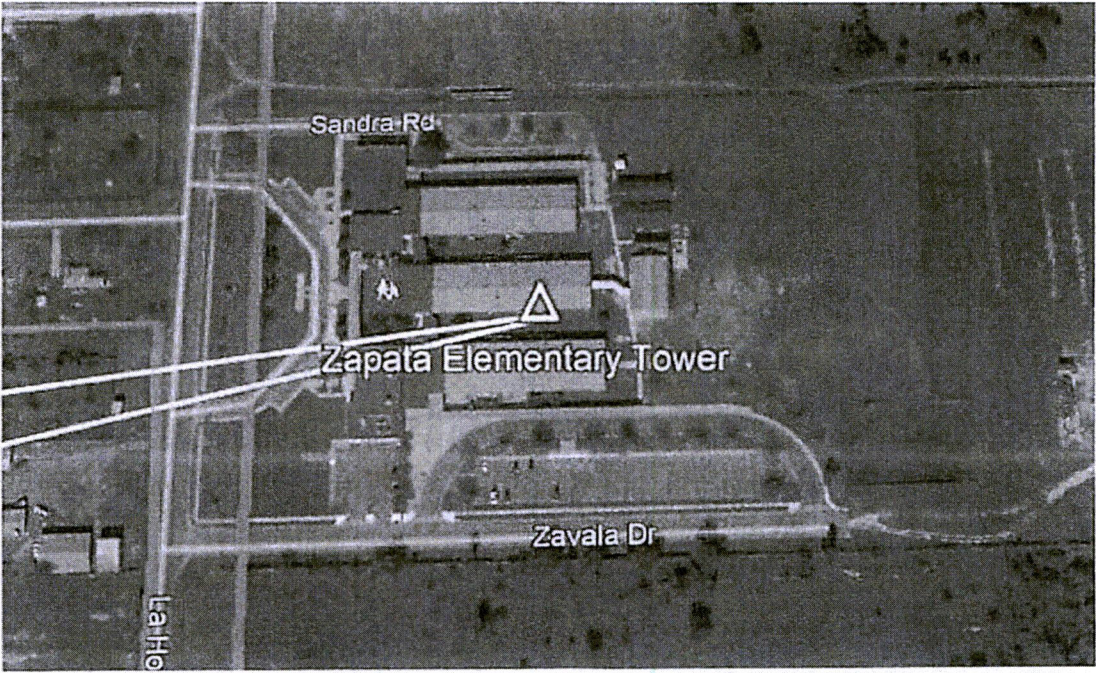



Precinct 3 Area - Zone 5

No. of Students: 2000 La Joya ISD

Sq. Miles: 1.44

Location: 5 Mile Line and N. Bentsen Palm Dr.



Proposed Tower Location

Location: Juan de Dios Salinas Middle School - La Joya ISD
6101 N Bentsen Palm Dr,
Mission, TX 78574

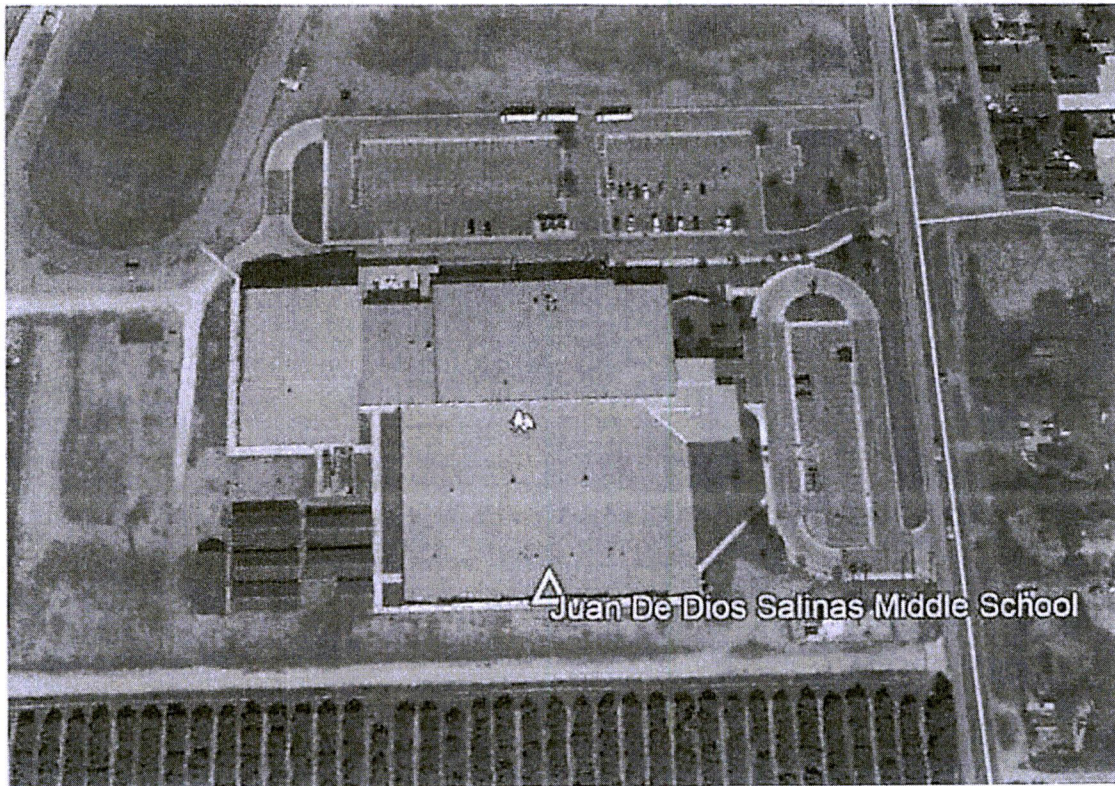



HIDALGO COUNTY

Information Technology

Precinct 3 Area - Zone 6

No. of Students: 2487 Mission CISD

Sq. Miles: 1.71

Location: Mission W. Griffin Pkwy



Proposed Tower Location

Location: Mission Food Production Center - Mission CISD
1201 W Griffin Pkwy,
Mission, TX 78572

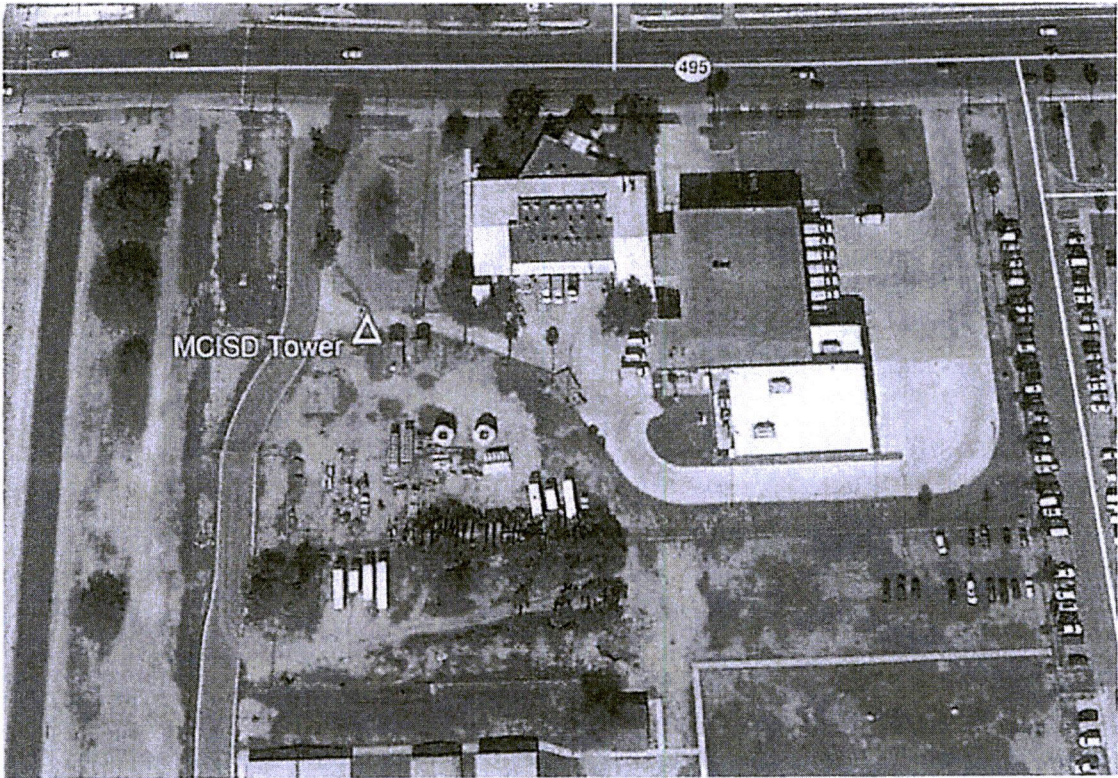



HIDALGO COUNTY

Information Technology

Tower Types

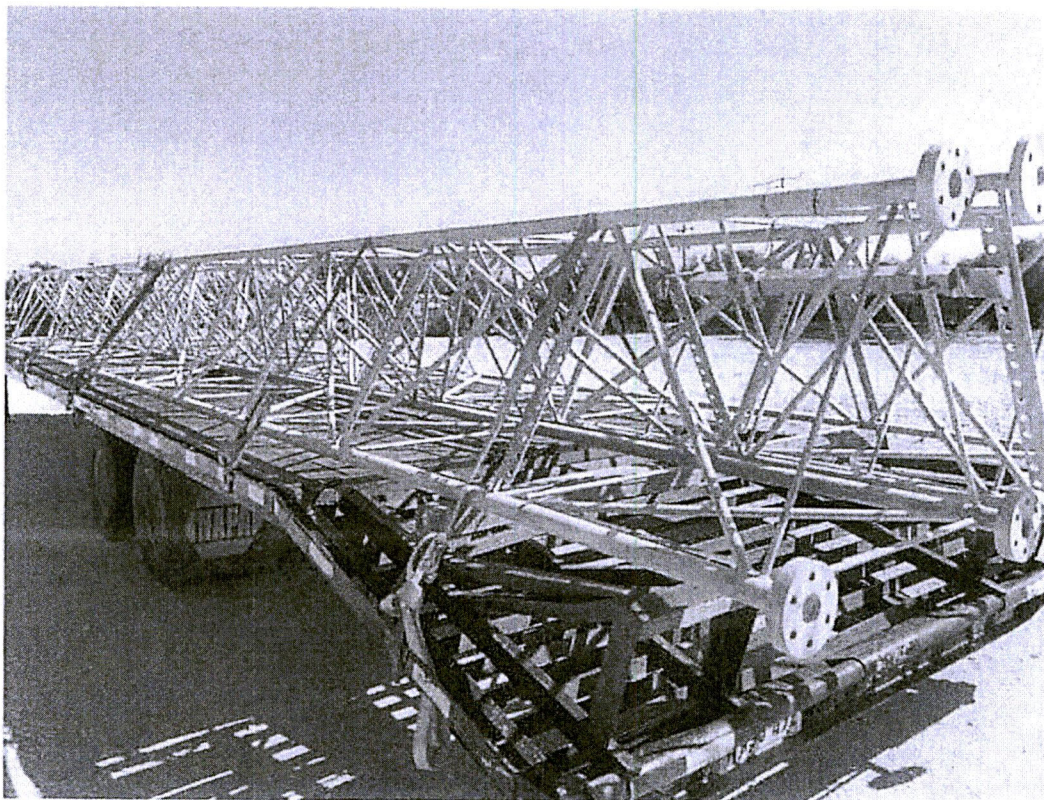

Type 1 - 75 FT Self Standing Tower

- 75ft Antenna
- 10x10 sq ft area for concrete and fencing
- Building must supply power to the tower
- Depth will be 9 ft from ground level

Below are the tower specifications:

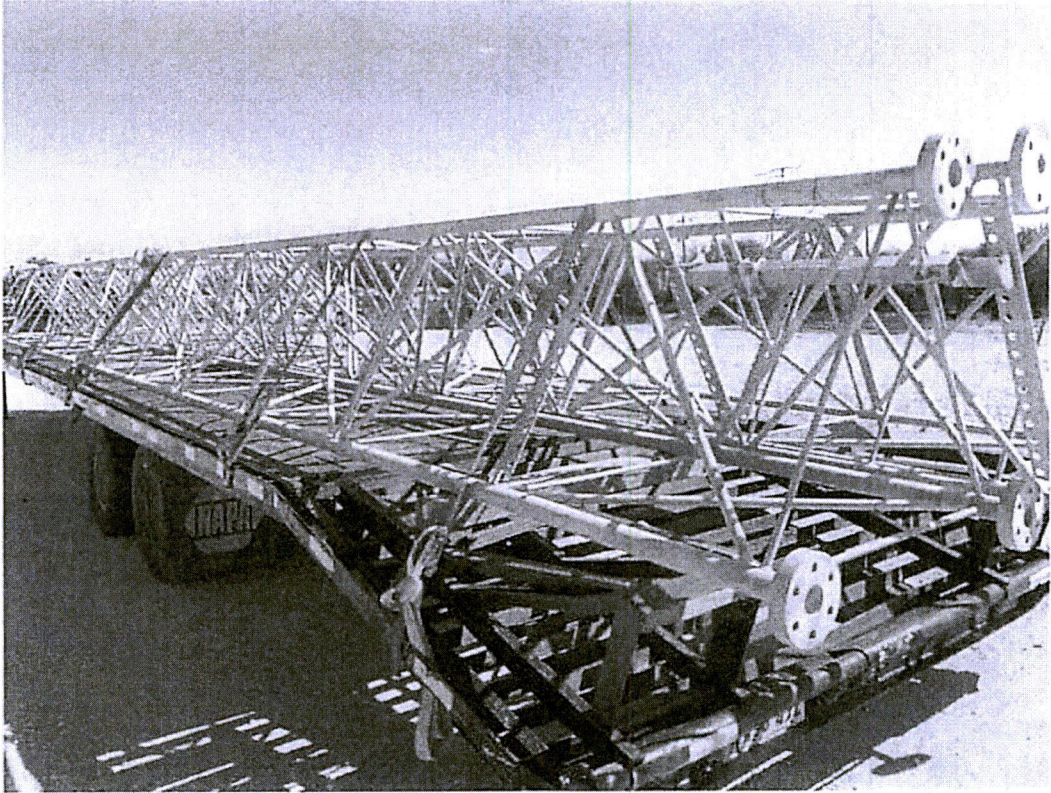



HIDALGO COUNTY

Information Technology

NOT FOR CONSTRUCTION

- NOTES
- 1 FOUNDATION FOUND IN PLACE
 - 2 43 CY CONCR
 - ONE PIER F

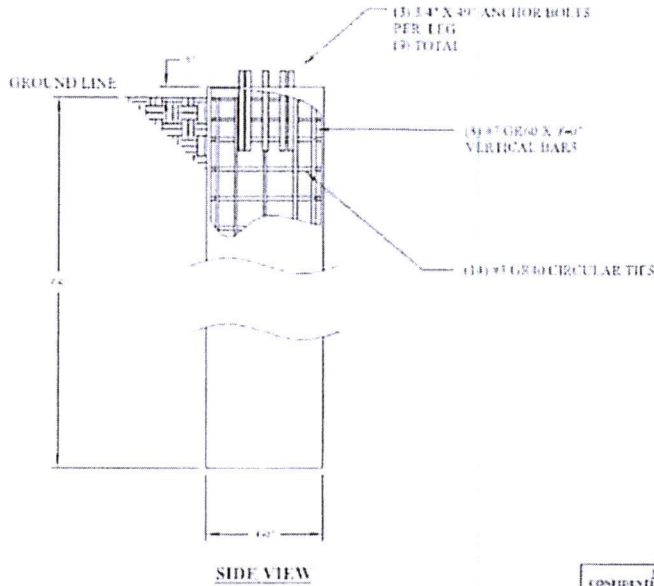

PROPRIETARY DRAWINGS
CONFIDENTIAL INFORMATION WHICH CANNOT BE
USED, COPIED, OR USED BY OTHERS WITHOUT
WRITTEN AUTHORIZATION BY WESTERN TOWERS
FORUM, BY WESTERN TOWERS ONLY

Antenna Type 2

Rooftop will require power from the building.

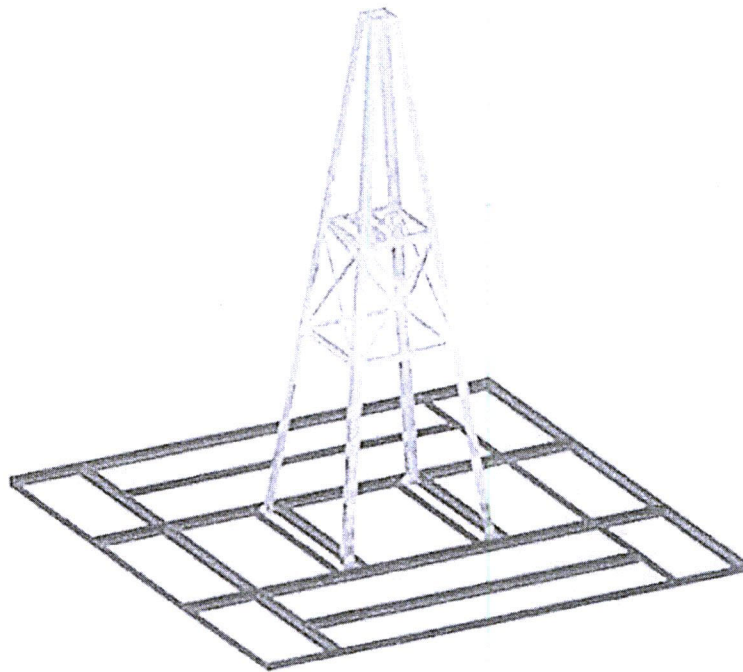



HIDALGO COUNTY

Information Technology

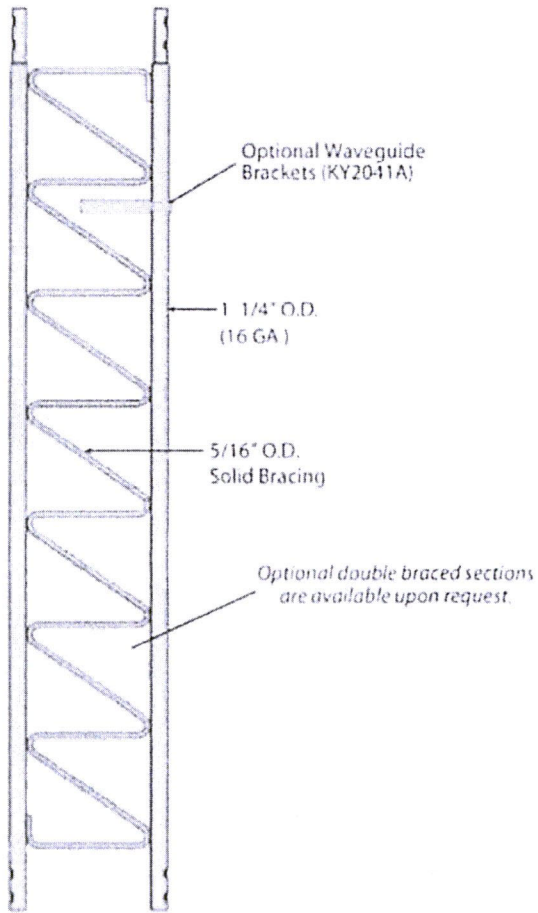

STANDARD SECTION
25G - 10' Section

OPTIONAL 7' SECTION
25G7 - 7' Section
The 7' Section is UPS shippable

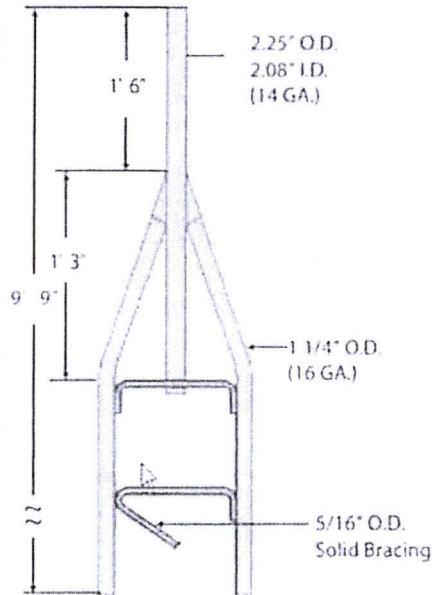

STANDARD TOP SECTION
25AG2

Additional 25G top sections are shown on page 37.

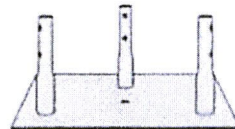

CONCRETE BASE PLATE
BPC25G*

FOR USE WITH 3/4X12 PIPER PIN
EMBEDDED IN CONCRETE

Additional base sections are available, please see page 38



HIDALGO COUNTY

Information Technology

The 25GBRM mount is designed to support one or two 25G tower sections in a self-supporting application. The 25GBRM mount is galvanized after fabrication for corrosion protection.

Order (1) optional BRM6MAT (1/8" thick) or (1) optional BRM6PAD (3/8" thick) for a protective barrier between the mount and the roof. Order (1) optional SCK150 safety cable kit (3/16" x 150").

Refer to page 256 for ballast requirements.

