



Design Framework



February 28, 2012

Contents

Design Framework – The COR.....	1
Purpose	1
Application	1
Implied Responsibility	1
Part One: Overall Framework	2
Overall Framework - Context.....	3
Overview	3
Guideline Recommendations.....	3
Objectives.....	3
Overall Framework – Street Hierarchy	5
Overview	5
Guideline Recommendations.....	5
Objectives.....	5
Transit Overview	8
Transit Guideline Recommendations.....	8
Transit Objectives	9
Overall Framework - Streetscape	10
Overview	10
Guideline Recommendations.....	12
Objectives.....	12
Street Trees and Plantings	12
Street Furniture.....	14
Sidewalks and Boulevard	14
Street Lights	15
Standards for Outdoor Dining.....	15
Overall Framework - Parking	16
Overview	16
Guideline Recommendations.....	16
Objectives.....	17

Minimum Standards.....	20
Private Streets.....	24
Loading Areas.....	24
Overall Framework – Building Design.....	25
Overview.....	25
Guideline Recommendations.....	25
Objectives.....	25
Architectural Overview.....	26
Architecture Recommendations.....	26
Overall Framework - Signage.....	29
Overview.....	29
Guideline Recommendations.....	29
Objectives.....	29
Definitions.....	29
Standards.....	32
Overall Framework – Stormwater Management.....	42
Overview.....	42
Objectives.....	42
Guideline Recommendations.....	42
Overall Framework – Parks/Public Spaces.....	44
Overview.....	44
Guideline Recommendations.....	44
Objectives.....	44
Part Two: Sub-district Framework.....	45
Overview.....	45
Public Realm/Streetscape.....	45
Plazas.....	45
Architecture.....	46
Minimum Standards.....	46
Sub-District Framework - COR1 Mixed Use Core.....	51
Public Realm / Streetscape.....	51
Site Development.....	51

Architecture	51
Sub-District Framework - COR2 Commercial	53
Public Realm / Streetscape	53
Site Development.....	53
Architecture	53
Sub-District Framework - COR3 Workplace	56
Public Realm/Streetscape	56
Site Development.....	56
Architecture	56
Sub-District Framework - COR4 Neighborhood	58
Public Realm/Streetscape	58
Site Development.....	58
Architecture	58
Sub-District Framework - COR5 Parks & Open Space	60
Public Realm/Streetscape	60
Site Development.....	60
Architecture	60
Implementation	62
Introduction	62
Design Review	62

List of Figures

Figure 1: Development Master Plan 5.03	4
Figure 2: Street Hierarchy Map.....	7
Figure 3: Master Lighting Plan	11
Figure 4: Streetscape Master Plan	18
Figure 5: Parking District Map.....	19
Figure 6: Signage Plan	31
Figure 7: Sub-district Map.....	50

Appendix A: Specifications and Details

Design Framework – The COR

Purpose

The primary purpose of Design Framework is to set basic parameters, describe preferences and illustrate design intent. These framework standards serve as a framework within which creative design can and should occur – there is no one solution, but many options that meet the basic requirements of this document.

Application

The format and content of this framework are specifically tailored for use as a supplement to the Zoning Ordinance. This document is organized into two sections. The first section outlines issues and recommendations that apply to the entire COR. The second section highlights specific framework that apply to each sub-district within The COR. The City of Ramsey has adopted Development Plan 5.03 as the Master Plan for The COR. This master plan provides illustrative guidance for building locations and orientation. Any changes to this approved master plan must be reviewed and approved by the City Council as part of the development application. This Development Plan will be updated by the City as changes are approved.

Implied Responsibility

All participants in the development of The COR recognize the local and regional impacts of this project and the various systems that play an important role. Each parcel and each building must fit within the context of the entire plan. Individual projects must complement, not compete with, adjacent development in terms of public green space, walk and trail connections, stormwater management solutions, street layout, parking strategies, land use mix and building design.

Part One: Overall Framework

There are a number of framework standards that apply to the entire COR, including recommendations for stormwater management, parks, streets, land use, parking, transit and other development components. Many of these overall COR framework standards overlap, or are integrated with one another. For ease of discussion they are categorized according to the same list of 'layers' that formed the basic structure for the Master Framework:

- Context – local, city, regional
- Street Hierarchy--access, circulation, arrangement
- Streetscape—preferred design, location
- Parking -- quantity, location, type
- Building Design-- preferred uses, horizontal/vertical mixed use, built form, character of development
- Signage—design, location, quantity, type
- Stormwater Management-- surface water features, stormwater management
- Parks/Public Spaces – parks, trails and open space

It is essential that proposed design solutions for development projects and other improvements within The COR demonstrate an understanding of the interplay between these layers.

Overall Framework - Context

Overview

The COR is a unique area within the City; but it is a part of, and connected with, a variety of local, city-wide and regional systems (See Figure 1: Development Master Plan 5.03). Each development project, whether a single building, one lot, or a series of blocks, must provide reasonable links to these systems as a primary design objective.

Guideline Recommendations

To ensure that The COR takes full advantage of local and regional systems, development should:

- Provide safe, easily recognized connections to city, county and state trail corridors
- Make provisions for city and regional transit service and amenities (including the Northstar Line) and encourage their use
- Tie into, and improve, the Ramsey utility network
- Integrate with and complement the existing (and future) street framework
- Become an integral part of the city and county drainage/stormwater management plan

Objectives

- Overall COR design (and all new private development within The COR) will accommodate stormwater from new projects and from off-site, and highlight stormwater features as an amenity
- Bikeways and pedestrian routes into The COR from adjacent neighborhoods must be designed for safety and ease of access, suggesting that a person on a bicycle has an equally accessible route to downtown.
- Parks and open space will be easily accessible to all COR residents, visitors, people who work here and also for the citizens of Ramsey and the surrounding area. This connected green system is reminiscent of the world renowned 'Grand Rounds' of Minneapolis.

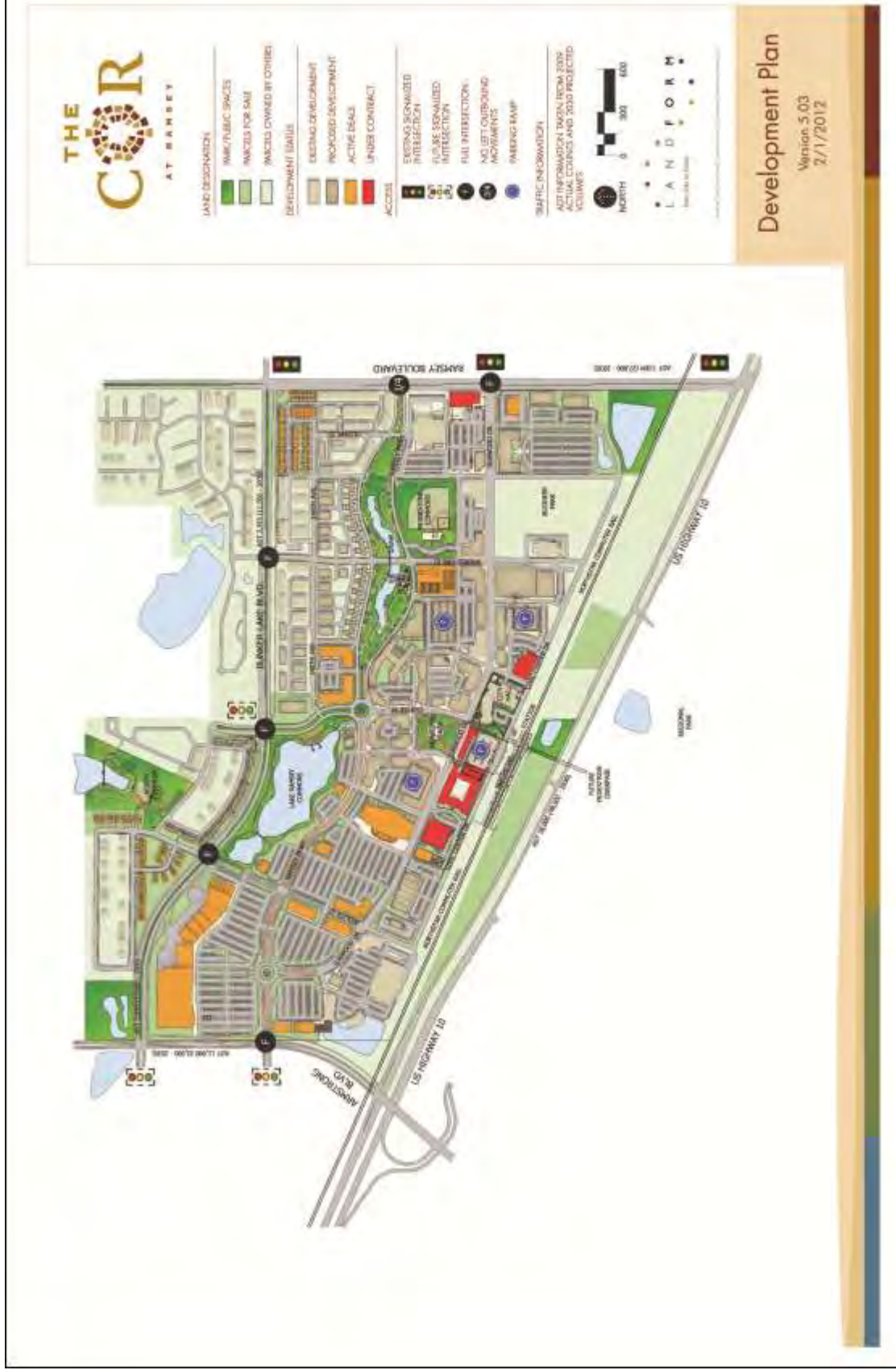

Figure 1: Development Master Plan 5.03

Overall Framework – Street Hierarchy

Overview

The Development Master Plan defines a specific strategy for the layout of streets and blocks within, and around The COR. The size, type and configuration of this street hierarchy (See Figure 2: Street Hierarchy) is based on a combination of projected traffic volume, level of service at intersections, proposed adjacent land use (destination commercial, residential, civic, recreation, etc.) and desired aesthetic character.

Great streets are essential components of an attractive and inviting public realm. These guidelines promote a street system that balances pedestrian and vehicular use. Providing streets that support traffic flow is important, but also creating ample space for street-side activities, strolling promenades, pockets of green and other amenities is critical to the success of The COR. Streets will promote convenient access by car – to storefronts, to parking lots and ramps, to entertainment attractions – but will also encourage foot traffic as a primary way to move about and conduct business in the core area.

Guideline Recommendations

The proposed street and block pattern reflects a compact urban character, not allowing dead end streets or cul-de-sacs, in favor of a traditional grid pattern and connected streets including the following:

- Provide a street network that distributes pedestrian and vehicular traffic throughout the various districts in The COR and encourages a more dispersed and less congested traffic flow (many choices or travel paths).
- Provide a clear hierarchy of streets resulting in a simple and understandable system for movement – easy access and convenient circulation throughout The COR.
- Work with Anoka County to convert primary perimeter streets (arterials such as Ramsey, Armstrong and Bunker Lake Boulevards) to urban street sections, providing sidewalks and street trees to replace roadside ditches.
- Promote improvements that invite pedestrian and bicycle use including wide sidewalks, streetscape amenities and designated bicycle trails (both on and off-street).



Objectives

Creative design solutions for public realm improvements should reflect these basic street classifications (street hierarchy) including:

- Arterial street – these streets provide the boundary of The COR and all access into The COR will be from one of these three streets:
 - Bunker Lake Boulevard
 - Armstrong Boulevard
 - Ramsey Boulevard
- Destination street – signature addresses for shopping, entertainment, services, work place and other primary amenities
 - Sunwood Drive



- Parkway – premier ‘green streets’ adjacent to primary public park / green space, with more landscaping than other streets in The COR
 - Ramsey Parkway
 - Center Street (north of the roundabout)
- Connector street – primary routes that link various districts within The COR, usually providing the most direct means of getting from point A to point B
 - Rhinestone Street
 - Zeolite Street
 - Veterans Drive
- Downtown street – the most urban of street sections where high pedestrian traffic is intended and traffic calming measures such as on street parking, bump outs and other methods will be employed
 - Center Street (south of the roundabout)
 - Sapphire Street (north of Sunwood)
 - Other streets as shown on the Street Hierarchy Map
- Local street – neither destination nor primary connector routes, these streets provide much of the rest of the street grid throughout The COR.



These street hierarchy classifications are intended to provide guidance regarding the streetscape, but it should be noted that within a street classification, there may be construction or design distinctions, based on the sub-district classification. For example, Sunwood Drive is defined as a destination street throughout The COR, but the design may be different between the COR1 and COR2 sub-districts. The Master Streetscape Map will provide design direction.

Transit Overview

The COR is designed to be a Transit Oriented Development (TOD) in a variety of ways that go beyond providing a walkable public realm and connected street grid. The Master Plan also includes a multimodal transit station, with dedicated commuter parking, integrated with other uses at the heart of the retail, restaurant and entertainment district. This station functions as a hub where local circulator transit comes together with regional transit service and the Northstar Corridor. The COR is the Twin Cities' first and only transit-oriented development along the new Northstar Commuter Rail Line. Ramsey Station at The COR will open for riders boarding the train in November 2012. As Northstar's most visible station, The COR will immediately bolster the ridership on the line and continue to build recognition for this regional service.



Transit components include the following:

- Ramsey Star Express service provides peak period, peak direction bus service between downtown Minneapolis and Ramsey until the Northstar Commuter Rail station stop is complete
- Northstar Commuter Rail provides train service between Big Lake and downtown Minneapolis
- 350 park and ride parking spaces are provided for commuters adjacent to the transit station
- Pedestrian and bicycle connections are emphasized in the Master Plan as major links between the transit station, various districts within The COR and into the surrounding neighborhoods
- The COR can accommodate Metro Mobility, citywide circulator bus or town trolley connections as part of local and regional service to the transit station



The COR also encourages developers to participate in a Travel Demand Management (TDM) program to both assist and encourage residents and visitors to take advantage of the various modes available for their commuting and travel needs. The TDM program draws from incentives and services available through Anoka County and Metro Commuter Services that match riders with carpools and vanpools, provide discounted transit passes and manage work hours among other functions.

- Developers shall submit a TDM plan with their site plan application for new development and work with the City to implement their plans.

Transit Guideline Recommendations

Transit is an important component of the overall plan, with expectations for more ridership, using a greater range of transit options as they become available. More people, together with the mix of activities and amenities in The COR, encourages better designed, better connected transit service. It is a shared responsibility between city, county and developer to promote transit use, with both policy and bricks-and-mortar attention to the following framework:

- Understand and take advantage of opportunities to use existing and proposed transit components

- Provide transit related facilities specifically linked to uses and character within each COR district, including signage and lighting for way-finding and bicycle amenities
- Building future Northstar Commuter Rail riders through the Ramsey Star Express bus service

Transit Objectives

The primary objective is to provide a balance of transit service, bicycle and pedestrian connections and lanes to move traffic. The framework for The COR promotes public transportation as part of the solution and suggests a variety of street improvements and other amenities to invite increased use. Photographs throughout the framework suggest some of the many possibilities.

Overall Framework - Streetscape

Overview

The Master Plan defines a specific strategy for the layout of streets and blocks within and around The COR. The amenities within the public right-of-way -and immediately adjacent -play an important role in the aesthetics of The COR. Great streets are essential components of an attractive and inviting public realm. Developing a streetscape that is comfortable and inviting to pedestrians is important to realizing the vision for The COR. The framework will encourage interesting and inviting places for the public.

The Streetscape framework defines the visual character and physical improvements for all public spaces within The COR. The document also provides the general framework and examples for design of proposed quasi-public and private space located within each development parcel.

Public realm/streetscape framework focus on the following elements:

- Parks, plazas and other public gathering spaces
- Street/sidewalk character and streetscape elements
- Bicycle/pedestrian connections (on-street and off-street)
- Residential courts, pocket parks and other private green space



The goal is to foster a safe and interesting public realm that will invite pedestrian activity, promote traffic calming, increase transit use and encourage community gathering. Street trees, lighting and decorative fencing provide the backbone for streetscape improvements. Added detail, such as special pavements, street furniture, public art and layered plantings will highlight specific nodes or uses. The City has developed a series of street cross-sections to illustrate these design expectations. Typical street sections are provided in Appendix A as a reference.

Destination and Connector streets must balance a high level of service for the automobile with attractive and inviting amenities for the pedestrian including:

- Provide gracious sidewalk width to support intensity of pedestrian traffic in the core
- Install street trees to frame the street and provide shade
- Provide street lighting that meets all safety standards and design criteria, while creating a signature character for this district
- Explore a range of options for streetscape improvements including special pavements, interesting concrete tinting or scoring patterns, additional plantings, ornamental fencing and other features (note, however, that simpler is better and too much clutter is a negative)



The COR includes a network of bicycle/pedestrian trails and walkways (both on and off-street) that connect adjacent sub-districts to the Mixed Use Core. As you approach the core, these connections tend to become part of the shared right of way along the major streets, or become part of the urban park spaces. Bicycle riders may choose to share the street with vehicular traffic, or dismount and walk their bicycles along with the other pedestrians using the sidewalks. Providing and maintaining these bicycle and pedestrian connections should be a key component for all development projects in the core.



Figure 3: Master Lighting Plan

Guideline Recommendations

The proposed street and block pattern reflects a compact urban character, including the following:

- Bike racks interspersed throughout The COR to encourage cycling as an alternative mode of transportation.
- Benches on the public sidewalks to encourage people to linger in The COR
- Trees and planters along the streets to create an inviting space
- Wide sidewalks and both on- and off-street bicycle trails
- Kiosks and other way finding tools for visitors and residents in The COR
- Outdoor dining is encouraged on the street side of buildings within all districts.
- Public plaza space is strongly encouraged to be located adjacent to the streets



Objectives

Creative design solutions for streetscape improvements should include:

- Streetscape improvements that provide traffic calming, particularly along Destination and Downtown streets
- Inviting streets that draw you into and through The COR
- A marriage of building design and streetscape design that encourages active spaces near the streets



Street Trees and Plantings

Street trees and planter boxes are a critical element in the unique character of The COR and will be used to help distinguish between different street types and sub-districts within The COR. However, there may be variety within the same street when the street crosses into sub-districts.

- Street trees will be chosen to ensure that the species allow for clear pedestrian access along the streets and require minimal maintenance.
- Along Destination, Downtown, Parkway and Local streets, where regularly spaced blocks exist, one (1) tree species shall be provided per block. In order to provide variety and protect against disease, adjacent blocks shall not be allowed the same street tree. Initial development along a block shall establish the tree species for that block, subject to City review and approval.
- Along streets without regular block space or longer blocks, such as Connector and Arterial streets, the City may approve groupings of 3-6 trees of one (1) species in lieu of the regular block spacing.
- Alternatives to the above mentioned planting plan shall be subject to review and approval by the City Council.

Destination Street Trees:

- Autumn Blaze Maple (*Acer x freemanii* 'Jeffersed')
- Bicolor Oak (*Quercus bicolor*)
- Sienna Glenn Maple (*Acer x freemanii* 'Sienna')
- Skyline Honeylocust (*Gleditsia triacanthos var. inermis* 'Skyline')
- Ginkgo (*Ginkgo biloba*)
- Accolade Elm (*Ulmus x 'Accolade'*)

Parkway Street Trees:

- Valley Forge Elm (*Ulmus americana* 'Valley Forge')
- Bitternut Hickory (*Carya cordiformis*)
- Siouland Poplar (*Populus deltoides* 'Siouland')
- Sienna Glen Maple (*Acer x freemanii* 'Sienna')
- Boulevard Linden (*Tilia americana* 'Boulevard')
- Northern Catalpa (*Catalpa speciosa*)
- Spring Snow Crabapple (*Malus* 'Spring Snow')
- Kelsey Crabapple (*Malus* 'Kelsey')
- Korean Mountain Ash (*Sorbus alnifolia*)
- Ohio Buckeye (*Aesculus glabra*)
- Ginkgo (*Ginkgo biloba*)

Connector Street Trees:

- Bicolor Oak (*Quercus bicolor*)
- Northern Red Oak (*Quercus rubra*)
- Princeton Elm (*Ulmus americana* 'Princeton')
- Accolade Elm (*Ulmus x 'Accolade'*)
- Autumn Blaze Maple (*Acer x freemanii* 'Jeffersed')
- Skyline Honeylocust (*Gleditsia triacanthos var. inermis* 'Skyline')
- Kentucky Coffeytree (male) (*Gymnocladus dioicus*)
- River Birch (single stem) (*Betula nigra*)
- Black Alder (*Alnus glutinosa*)
- Black Cherry (*Prunus serotina*)
- Spring Snow Crabapple (*Malus* 'Spring Snow')
- Kelsey Crabapple (*Malus* 'Kelsey')
- Japanese Tree Lilac (*Syringa reticulate*)
- Thornless Cockspur Hawthorne (*Crataegus crus-galli var. inermis*)

Downtown Street Trees:

- Princeton Elm (*Ulmus americana* 'Princeton')
- Accolade Elm (*Ulmus x 'Accolade'*)
- Autumn Blaze Maple (*Acer x freemanii* 'Jeffersed')
- Skyline Honeylocust (*Gleditsia triacanthos var. inermis* 'Skyline')
- Kentucky Coffeytree (male) (*Gymnocladus dioicus*)
- River Birch (single stem) (*Betula nigra*)
- Black Alder (*Alnus glutinosa*)
- Black Cherry (*Prunus serotina*)
- Spring Snow Crabapple (*Malus* 'Spring Snow')
- Kelsey Crabapple (*Malus* 'Kelsey')
- Japanese Tree Lilac (*Syringa reticulate*)
- Thornless Cockspur Hawthorne (*Crataegus crus-galli var. inermis*)

Local and Arterial Street Trees:

Local and Arterial Street trees may be chosen from any species on the above lists.

Planter Beds/Boxes/Tree Grates

- Planter beds, tree grates and planters shall be as shown on the Streetscape Master Plan. Details and specification shall be added to Appendix A as developed and approved by the City. Appendix A shall be amended as needed.
- Irrigation shall be provided to ensure survival of plant materials. The City shall provide irrigation systems along the Parkway and Destination streets. Unless otherwise approved, all other irrigation shall be the responsibility of the landowner.

Street Furniture

Bike racks, trash enclosures and benches are encouraged on all streets, but will be required on Destination, Connector and Parkways and other streets as shown conceptually on the Streetscape Master Plan.

Bike racks shall be the standard bike rack (see Appendix A for specifications).

Trash enclosures shall be the standard trash enclosures (see Appendix A for specifications).

Benches shall be the standard bench (See Appendix A for specifications).

Benches shall be grouped in twos that face each other and provide an opportunity for an outdoor conversation space.

Alternative bike rack, trash enclosures and bench designs will be considered on a case-by-case basis. The City will review alternative designs as part of the site plan review and will evaluate these alternatives based on the following:

- Does the design maintain the character of the district?
- Does the alternative design maintain the quality of the standard feature?
- Does the design provide a relationship between the public elements of the streetscape and the building that would not otherwise be possible?

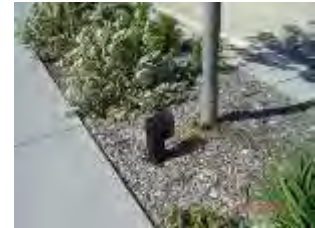

Sidewalks and Boulevard

In the design framework, the term “boulevard” is defined as “the space between the sidewalk and the curb.” The boulevard area provides the required space for public features such as street lights, benches, fire hydrants, street signs, etc. The boulevard will have different characteristics based on the street hierarchy.

The street width and layout within different zones may affect the ability of a particular development to provide the minimum boulevard width and the minimum sidewalk width within the existing public right-of-way. In those cases, the landowner shall provide a permanent public easement over the portion of the sidewalk that is located on private property.

Street Lights

Street lights are owned and installed by Connexus Energy. The streetlight design was developed in conjunction with the City of Ramsey and Connexus (See Figure 3: Master Lighting Plan). The standard street lights are designed to accommodate banner arms should banner signage be desired. The banner arms should be the manufacturer's standard break-away banner arms to ensure safety and minimize maintenance costs. Connexus provides street light maintenance for the City. Connexus bills the City of Ramsey for the cost of installation and maintenance.

The choice of street light was intended to emphasize the pedestrian scale of The COR. Light poles within the public right-of-way should be planned to accommodate banners, flowers, hanging artwork and electrical outlets.

There are three (3) different streetlight types within The COR:

- 24-foot high poles at intersections
- 14-foot high poles at mid-block
- 12-foot high poles at The Draw



The City will ensure that the appropriate streetlights are installed on all public streets as described by the Design Framework. Private developers shall provide parking lot or other project lighting that retains these design

objectives. All lighting shall comply with City Code performance standards for lighting. All lighting shall be reviewed by City staff to ensure compliance with the Design Framework and City Code standards described above.

Standards for Outdoor Dining.

Outdoor dining is encouraged as an attractive addition to a pedestrian- and retail-friendly, vital COR. Such dining is encouraged subject to the standards in Section 117-118 of the Zoning Ordinance.

Overall Framework - Parking

Overview

Balancing the realities of car-related necessities (streets, parking and so on) with future transit service and the desired character of The COR is a significant challenge. The goal is to provide adequate parking; both quantity and location, while promoting new strategies that support the overall needs of The COR. Parking will be provided through a combination of on street spaces, off-street surface lots, underground lots and structured ramps to support the mix of uses at the core.

Parking structures should contribute to the overall character and image of The COR. Ramp design should include elements, colors and materials that reflect, or complement surrounding buildings. Liner stores or other street level uses should be integrated into ramp design along important street frontages. The City also encourages developers to wrap the ramp with multi-story uses that will provide commercial and residential opportunities and help to define the street edge.

Guideline Recommendations

Parking guidelines encourage the following:

- Locate surface parking lots away from the major streets, either behind or to the side of primary buildings; surface parking lots along major street frontage are not allowed in the core area
- Minimize surface parking lots in favor of other solutions including underground parking to serve residential buildings, on-street parking to serve retail shops and parking ramps
- Provide a combination of fencing, landscaping and landform to screen parking areas from major streets and important views, soften parking area edges, provide shade, integrate native plantings, offset islands and reduce to 'sea of parking' image
- Create strategies for shared parking between adjacent uses, taking advantage of peak and off-peak cycles, business hours, nighttime activities, special events and other needs
- Provide alternative surfaces for secondary (less frequently used) parking areas including porous pavements, green pavements and so on
- Provide facilities or services that respond to and connect with future transit to reduce required parking, including shuttle/circulator bus, bicycle lockers
- Provide flexibility including hours for on-street parking, security and enforcement practices, permit or metering
- Provide parallel parking on both public and private streets throughout The COR, to add parking and create a traffic calming, pedestrian buffer; Bumpouts are encouraged as a traffic calming measure on all streets within the COR.
- Explore options to integrate stormwater management requirements into parking area design
- Provide parking spaces for typical daily use, satisfying both quantity and location needs through a mix of on street, small surface lot, underground and ramped parking solutions
- Provide options for additional/overflow parking to support holiday traffic and special events including porous pavements, turf parking areas (Netlon and other soil amendments) or shuttle service from nearby parking areas
- Encourage shared parking solutions that target around the clock shifts in destination, audience or take advantage of peak/off-peak hours of operation for various uses within the core area

- Promote municipal parking ramps as the primary facility to meet public parking needs within the core area
- Discourage driveway access to parking facilities along Arterial, Destination and Parkway streets, in favor of side streets.

Objectives

The primary objective is to provide a balance of surface lots, on-street and structured parking, with ample quantities and close proximity to serve the mix of uses in The COR. The Design Framework anticipates the construction of a total of 3 parking structures in COR1 to serve the needs of the area by providing structured parking that can be shared among users, allow developers to maximize the development on each individual lot.

As discussed later in this section, sizing and timing of the structured parking will be finalized as the area develops and parking demand grows. In addition to providing adequate space, excellent design is a major factor as well. The framework for The COR encourages creativity, innovation, quality and attention to detail in every aspect of project development, including parking solutions. Photographs throughout the Design Framework suggest some of the many possibilities.





Figure 4: Streetscape Master Plan

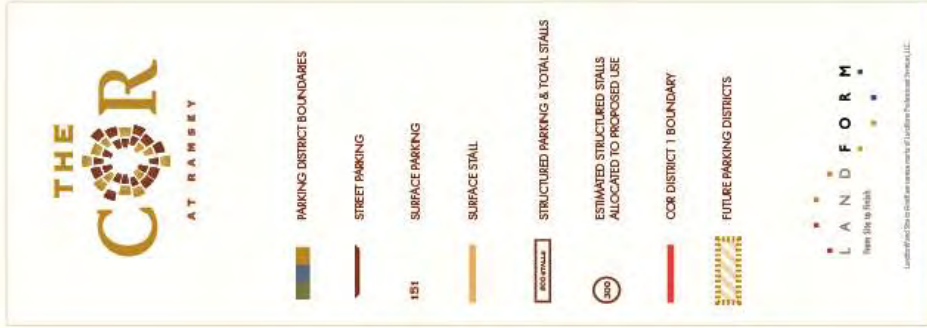

Parking Districts
 VERSION 5.03
 9/27/11

Figure 5: Parking District Map

Minimum Standards

Parking in The COR is intended to be shared to the greatest extent practicable in all mixed-use areas. The parking standards are intended to provide a practical basis for providing adequate parking within the COR District through a careful analysis of uses, shared parking arrangements, use of public street parking and reduction allowances for the proximity to the transit station. A parking plan has been prepared to identify the planned number, location, sharing arrangements and public use (see Figure 4: Streetscape Master Plan and Figure 5: Parking District Map). The parking plan provides information that can be used to help address longer term parking arrangements where the possibility of use conversion or building expansion exists. Parking shall be provided under any of the following arrangements:

- A. No parking shall be located between the front of the principal structure and the street on parcels abutting Destination and Downtown streets in COR1.
- B. Not more than fifty (50%) percent of the parking shall be located in front of the principal structure and the street on parcels abutting Arterial, Parkway, Connector and Local streets.
 1. In the COR2 district, developments may be allowed more than fifty (50%) percent parking in the front yard, provided all other design standards have been met, including the use of a wall, railing, hedge or combination to create a street edge and screen parking.
- C. Wherever a surface parking area faces a street frontage, such frontage shall be screened with a decorative wall, railing, hedge, or a combination of these elements, to a minimum height of three feet (3') and a maximum height of four and one-half feet (4¹/₂') above the level of the parking lot, at the build-to line required for the property. The amount of required screening may vary by sub-district and street frontage and is described in Part Two of this document.

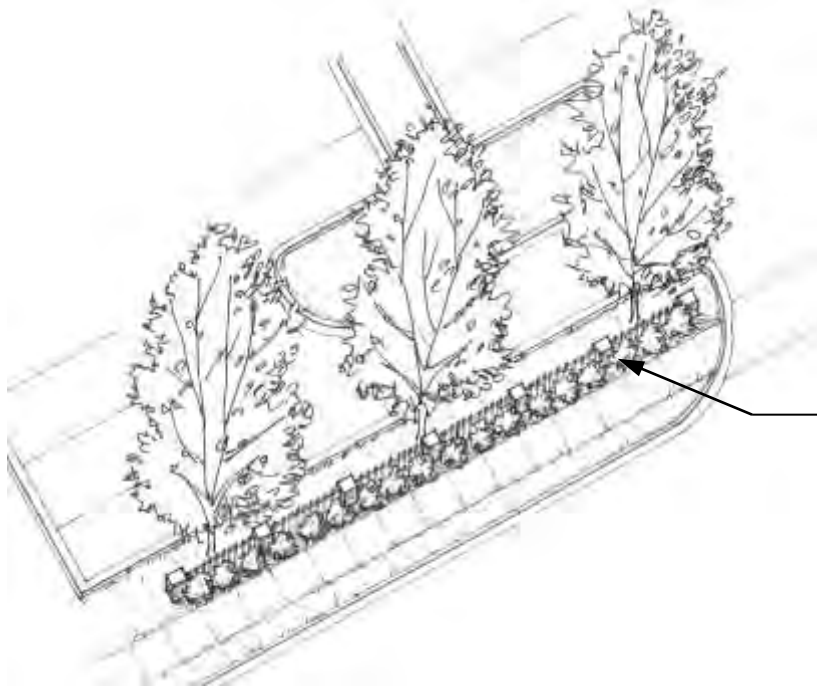

Landscaped edge that combines fence with trees, low shrubs and ground cover for parking lot screening and buffering along sidewalk to screen parking

- D. No parking spaces shall be located on corner lots at the point of street intersections.
- E. Shared parking in COR1 will be accomplished through a Parking Use and Maintenance Agreement (PUMA).
- F. Off-street parking in the COR2 and COR3 sub-districts shall be secured for public use through parking easements and other appropriate conveyances. Shared parking arrangements between nearby uses are encouraged in both sub-districts.
 - 1. The City may approve joint parking for one or more businesses where the total number of parking stalls provided for joint use is less than the sum of the total required for each business should they provide them separately. The applicant must demonstrate the feasibility of the arrangement in a written report. Such a permit shall not be granted except when the following conditions are found to exist:
 - i. Proximity. The building or use for which application is being made to utilize the off-street parking facilities provided by another building or use shall be located within three hundred (300') feet of such parking facilities, excluding public rights-of-way.
 - ii. Conflict in Hours. The applicant shall demonstrate in documented fashion that there is no substantial conflict in the principal operating hours of the two (2) buildings or uses for which joint use of off-street parking facilities is proposed.
 - iii. Written Consent and Agreement. A legally binding instrument, executed by the parties concerned, for joint use of off-street parking facilities, duly approved as

to title of grantors or lessors, and in a form and manner of execution approved by the City Attorney, shall be filed with the City Clerk and recorded with the Anoka County Recorder or Registrar of Titles, and a certified copy of the recorded document shall be filed with the City within sixty (60) days after approval of the joint parking use by the City or the interim use permit shall be considered null and void.

- G. On-street parking adjacent to buildings shall not be used for the purposes of calculating parking requirements.
- H. Within the COR-4 sub-district, parking on individual parcels serving individual uses may be provided if designated and approved as part of the master plan.
- I. Within all sub-districts, a minimum driveway length of twenty-five (25') feet is required to limit conflicts between vehicles parked in the driveway and street or sidewalk users.
- J. In order to ensure the pedestrian orientation of the COR Districts, minimum/maximum on-site parking standards are set based on the following table:

Table 1

Use	Minimum number of parking stalls	Maximum number of parking stalls*
Retail	2 per 1,000 sq. ft.	4 per 1,000 sq. ft.
Restaurants	3 per 1,000 sq. ft.	5 per 1,000 sq. ft.
Offices	2 per 1,000 sq. ft.	3 per 1,000 sq. ft.
Medical offices, clinics	2 per 1,000 sq. ft.	4 per 1,000 sq. ft.
Health clubs	3 per 1,000 sq. ft.	5 per 1,000 sq. ft.
Theaters, places of assembly	1 per 5 seats	1 per 3 seats
Residential		
Attached or detached	1 per unit	2 per unit
Multifamily units	1 per unit	2 per unit

*If a parking structure is provided on site, maximum parking stalls do not apply.

- K. Non-Specified Uses. For uses not specifically listed above, off-street parking requirements shall be computed by the Zoning Administrator on the same basis as required for the most similar listed uses. In such cases, the Zoning Administrator shall also consult off-street parking reference materials including, but not limited to, manuals prepared by the American Planning Association and Institute of Transportation Engineers.
- L. Handicap Parking. The size, number, and location of stalls reserved for handicapped parking shall be provided and identified as required by applicable regulations. These spaces are included in the computation for the minimum parking space requirement.
- M. Change in Land Use. When the site intensity or use of a building and/or property is increased with consequential effect upon the parking requirements as prescribed in this Section, the

parking requirements as prescribed herein shall be used to provide for such increase in the site intensity and/or use.

- N. Use of required parking spaces. Required parking spaces must be available for the use of residents, customers or employees of the use. Fees may be charged for the use of required parking spaces. Required parking spaces may not be assigned in any way to a use on another site, except for joint parking situations. Also, required parking spaces may not be used for the parking of equipment or storage of goods or inoperable vehicles.
- O. Transit Service Reduction. The minimum number of parking stalls required on site may be reduced by 10% for any parcel located within ¼ mile of a transit stop. To qualify for this reduction, the transit stop must provide regular service on all days of the week and direct pedestrian access must be provided between the building and the transit stop.
- P. Bike Racks. In addition to the bike racks provided as part of the streetscape, individual businesses are encouraged to provide bike racks for customers. Bike rack locations will be reviewed and approved by the City as part of the site plan review.
- Q. Increase to Maximum Required Parking. If additional parking is sought to exceed these maximum requirements, a conditional use permit can be sought to increase maximums up to twenty-five (25%) percent.
 - 1. In the COR-2 sub-district, an increase of twenty-five (25%) percent in the maximum number of parking stalls is permitted without the issuance of a conditional use permit if approved as part of the site plan.
- R. In the COR1 sub-district, a PUMA (Parking Use and Maintenance Agreement) shall be applied to all development as follows:
 - 1. It is the City's intent to maximize development on individual lots. In order to help landowners accomplish this goal, the City will develop public parking ramps, which will be available for public parking within The COR. In order to minimize the amount of the site required for parking, the landowner may choose to enter into the PUMA for utilization of the public parking ramps to meet all or a portion of their minimum parking requirements.
 - 2. Each development shall be subject to a PUMA that specifies that each property in the COR1 shall be financially responsible for its proportionate share of a shared parking facility. The proportionate share shall be determined on the basis of the property's off-street parking needs, as determined by the parking requirements of Item J above.

3. The City shall establish fees by ordinance. The developer shall be responsible for payment in an amount equal to the value of the required parking on a per-stall price basis for ramp parking through the PUMA. The City will determine the appropriate contribution.
4. Funds collected by the City shall be deposited in a special fund used only to acquire and/or develop off-street parking facilities for the COR. Financial responsibility shall cover the construction and continuing maintenance of the parking facility.
5. The parking facility may be constructed and maintained by the City or by a private management entity acceptable to the City.

Private Streets

Private streets may be allowed within residential subdivisions, subject to the standards in Section 117-112 (e)3.b. of the Zoning Ordinance.

Loading Areas

- A. Loading areas and docks shall be located in the rear of the building.
- B. Loading areas shall not be located in the front yard and shall be fully screened from public streets, public parks and residential areas through landscaping and building design measures.



Overall Framework – Building Design

Overview

The COR Development Plan 5.03 identifies the preferred mix and approximate location of a variety of land use types. Together with the Zoning Code, this Design Framework focuses on the following overall objectives:

- Promote vertical and horizontal mixed use (within a building, within a block, within a district)
- Provide a variety of housing types, styles, pricing
- Encourage increased density in and around the central core area
- Promote an interesting mix of building styles, scales and massing for each sub-district
- Support creative, innovative, high quality design solutions as the benchmark for success
- Integrate mix of uses with public green space within each district
- Provide a variety of commercial types
- Mix residential and commercial uses to promote street-level activity throughout the day

Guideline Recommendations

The mix of land uses in The COR will encourage activity during the day and into the evening and nighttime hours. As a focus of commerce, employment, recreation and housing, The COR resembles a small to medium size Midwestern downtown in scale and character. Land uses are intentionally mixed, to bring shoppers and workers into the area during the day and attract new residents and visitors to entertainment venues in the evening.

The civic component of The COR, anchored by City Hall, Police Station and variety of public spaces and squares, adds an important element to the land use mix and brings a level of authenticity to the district.

Objectives

- Encourage vertical mixed-use in the core with housing and office space over retail uses along the street, particularly in the center of the district.
- In residential districts, particularly closer to the core, a limited amount of retail uses will be encouraged to service residents and provide nearby places to gather.
- Promote innovative models for housing that include a mix of townhomes, flats and lofts within single buildings or on the same block.
- Accommodate larger, ‘big box’ retailing and auto-oriented uses within the COR2 sub-district only if innovative design approaches are used including two story buildings, use of liner stores facing the street, minimal blank walls, creative parking strategies, etc.
- Where similar uses create a ‘family’ or campus of buildings (e.g. medical campus), buildings should reinforce the street edge and parking should be set within the core of the block.
- Uses shall promote pedestrian friendly streets, contributing to street level activities and overall visual character of each district.
- All uses should reinforce the street edge.



Architectural Overview

High quality architecture is an essential component in fulfilling the objectives of the Design Framework. Rather than prescribing a particular style, these architectural guidelines are intended to encourage an integration of both traditional and contemporary design. Architectural designs should provide a consistent quality, measured, to a great degree, by the pedestrian experience along the street and by an architectural expression that provides character without being thematic, obtrusive, or artificial. Architectural character should strive to be authentic and varied, but not 'thematic'.

Architecture Recommendations

Of all the layers that combine to form The COR Development Plan, architecture will typically be the most prominent development component. Both visually and physically, architecture will play a major role in defining the overall design character and mix of uses for The COR. It is crucial that the design and location of buildings address these architectural guidelines, with specific emphasis on the following:

- An animated street presence with a mix of street-level uses, interesting building façades, many doors and windows on the street, careful design of lighting, awnings, signage and other elements that animate the pedestrian experience

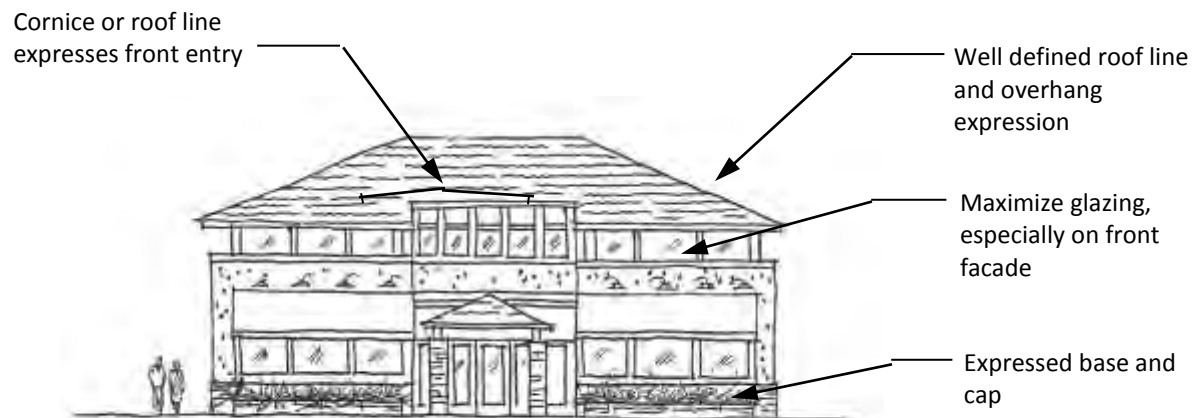

- Variety in building design, character and expression; not one theme or building style, but a thoughtful integration of many design solutions
- Variety of building types including a range of height, scale and proportion, that support an integrated mix of housing options, shopping destinations, entertainment venues, civic structures and other COR uses
- Use of high quality materials, suggesting a preference toward native materials and masonry elements, with respect for local building techniques
- Building location is as important as building style; special architectural elements, character, transparency and a higher level of materials and detailing should be used to highlight key streets and important crossroads throughout The COR
- Buildings should always be located at all four corners of intersections.
 - In the COR2 sub-district, if the City finds that there are unique circumstances where buildings cannot be located on the corner, the City may approve the use of fences, walls or other design elements to create that "street edge"

- Buildings will be located at the street right-of-way line (zero setback), but also allow recessed space for outdoor dining and other street level activities providing some minor deviation for variety
- Greater emphasis should be given to architectural elements, materials and other design features for buildings located at primary intersections, or where streets intersect with parks, such as the streets that front on or end near the Municipal Plaza. These locations can often be seen from several directions, perhaps terminate a view from a distance down the street or sit at a prominent node; They will likely become future landmarks or helpful orientation/wayfinding icons as The COR develops
- Encourage both vertical mixed use (within each building) and horizontal mixed use (within each block) throughout this district
- Include a mix of housing, civic, retail, restaurant, entertainment, performance and other uses that encourage a variety of activities throughout the day.
- Minimize openings between buildings, although limited driveway access and some provision for pedestrian connections through blocks are encouraged – gaps between buildings to accommodate surface parking lots, greater building setbacks or other purposes are discouraged
- Use recessed entries and windows to create street-level interest, variety and enhance pedestrian scale along street frontage

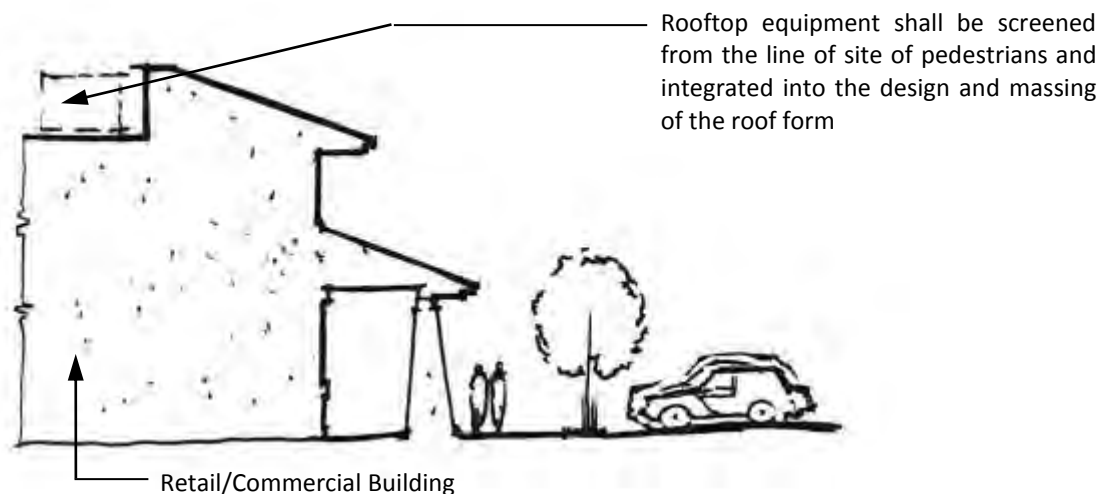
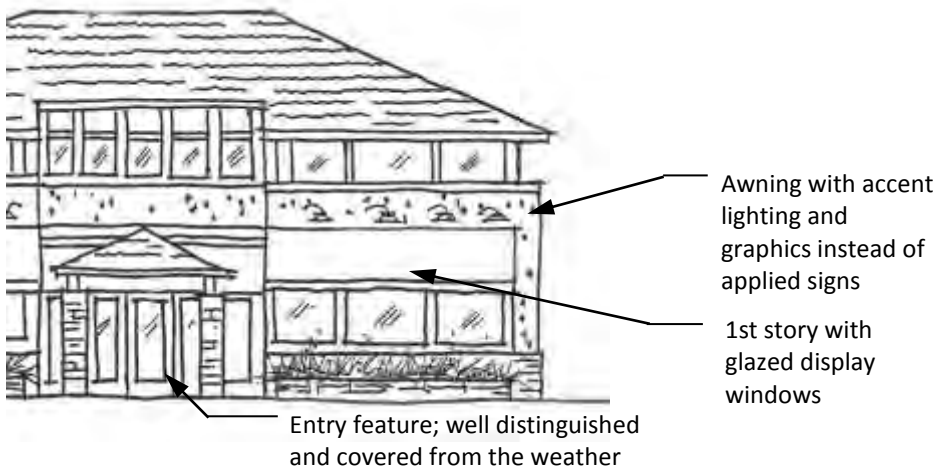

- Equipment, mechanical systems, transformers, etc. must be screened from view in a way that is integral to the architecture of the building. Screening should be accomplished with materials similar to or compatible with materials used on the main structure; metal fencing or mechanical vent screens alone are not sufficient.
- Roof lines and cornice details shall be completed in a 3-dimensional manner so that the back of roof features or similar unfinished areas are not visible.

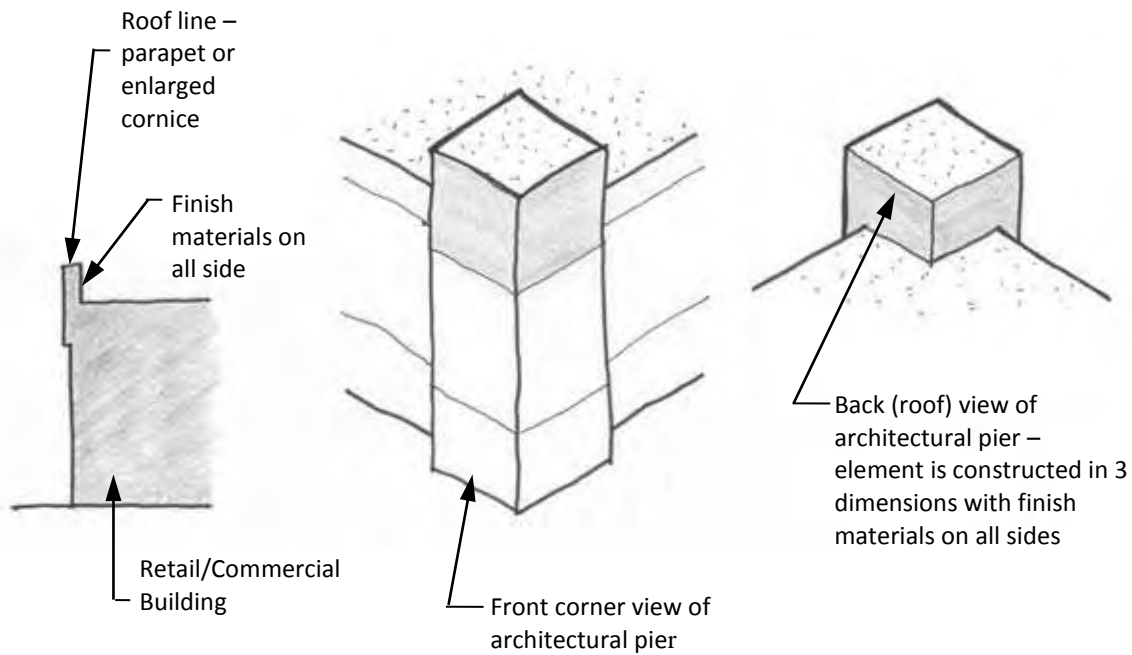

Overall Framework - Signage

Overview

Signage within The COR should provide a system for clear wayfinding for all modes of transportation and should ensure successful business operation while maintaining the design aesthetic of this unique project. These sign standards are intended to allow flexibility and creativity while maintaining the design concepts of The COR. Due to the distinctive nature of The COR, the sign standards from the City Code are not applicable and signage shall be allowed as prescribed by the Design Framework. A Master Sign Plan identifies the location of key sign locations (see Figure 6: Signage Plan).

Guideline Recommendations

The COR development manager shall prepare a Master Sign Plan for the public elements of the project, which are in compliance with the design framework and will be adopted by reference. The Master Sign Plan will specifically address public signs including:

- The three (3) off-site community signs
- Banner signs on light poles
- Signage for public parks
- Signage for public parking ramps
- Signage for public buildings
- Community kiosks



Objectives

Signage should be used as a tool to help identify businesses and neighborhoods with The COR and should have elements that are focused on the pedestrian nature of The COR as well as the signage needs for businesses.

- Signage and lighting which is integrated into the design of the building is encouraged.

Definitions

Awning Sign means a sign incorporated into or attached to an awning.

Community sign means an off-site sign identifying the development name and key tenants. Community signs may also include public information. Reader boards are allowed to be incorporated into community signs within The COR.

Temporary Sign means a sign which is erected or displayed for a limited period of time and not affixed to a Minnesota State Building Code approved structure.

Project sign means a freestanding area identification sign which identifies a single-family or multifamily residential subdivision, a commercial development or an industrial park or office park and which is located on the same parcel as the development it identifies.

Projecting sign means any sign, all or any part of which extends beyond the surface of the building or wall by more than 16 inches.

Public Realm/Streetscape sign means any sign erected and maintained by public officials or public agencies, or approved and authorized for use by state or local governmental authorities.

Sandwich Board Signs means a self-supporting, freestanding temporary sign with only two (2) sides that are situated adjacent to a business with the intent to attract pedestrian traffic to businesses. Sandwich board signs are not meant to be read by vehicular traffic.

Wall sign means any sign which is affixed to a wall of any building. This definition includes individual letter signs and signs on mansards.

Window sign means a sign installed inside a window, or any sign placed within a building for the purpose of being visible from the public right-of-way. This does not include merchandise on display.

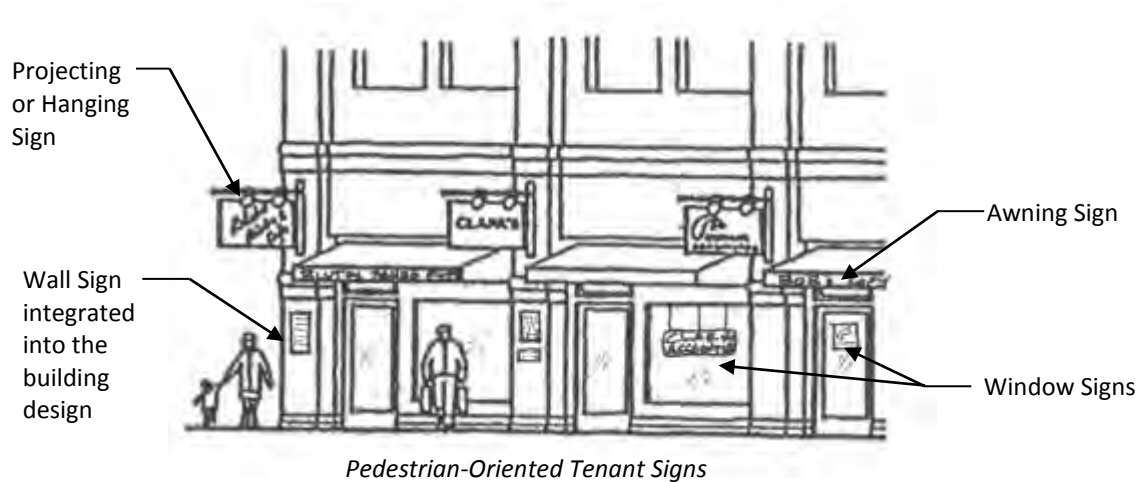

Standards

Public Realm/Streetscape Signs

The pedestrian oriented nature of The COR requires unique signage that will build on the design concepts for The COR. These types of signs include banner signs on the streetlights, kiosks, street signs, wayfinding signs, signage for public parking ramps, etc. As the design concept for The COR has been refined, so has the signage plan. The COR development manager shall develop standards for these public realm signs as part of the Master Sign Plan. The Master Sign Plan shall be incorporated by reference and may be updated from time to time. Such signage shall be allowed on public spaces as needed to provide information and wayfinding. No advertising shall be allowed on Public Realm/Streetscape Signs except for community events.

Community signs

Community signs include are planned to include three (3) signs on Highway 10, as shown on the Signage Plan (see Figure 6: Signage Plan). The signs include the existing Community Sign near the future transit plaza, the sign at the northwest corner of Highway 10 and Ramsey Boulevard and the planned sign at the northwest corner of Highway 10 and Armstrong Boulevard.

These off-site signs are allowed as shown on the signage plan and shall have consistent materials and colors. The Master Sign Plan shall detail the materials, colors and standards for these three (3) community signs. The Master Sign Plan shall include standards for which tenants shall be allowed on the community signs.



Desirable signs are designed to be architecturally compatible with buildings within the development and other signage within the development

Project Signs

Project signs are permitted within all COR sub-districts.

One (1) freestanding sign is allowed per building, provided that the following standards are met:

- A. The building in which the advertising business is located, shall be set back a minimum of six (6) feet from a public street right-of-way.
- B. The area of each face of the signboard shall not exceed six (6) square feet and the signboard shall not have more than two (2) readable faces
- C. The height of the top of the signboard, or of any posts, brackets, or other supporting elements shall not exceed six (6') feet from the ground.

- D. The signboard shall be constructed of wood, acrylic, aluminum or metal and shall be architecturally compatible with the style, composition, materials, colors and details of the building.
- E. No part of the sign shall encroach on the right-of-way and its location shall not interfere with pedestrian or vehicular circulation.
- F. Limited to one (1) sign per building and shall not be in addition to wall-mounted, applied letter or projecting signs.
- G. The readable faces of the sign shall be perpendicular to the adjacent street.

In the COR2 District, the following signage shall be allowed:

- A. Ground sign. There shall not be more than one (1) ground sign for each parcel. The gross surface area of a ground sign shall not exceed one hundred (100) square feet for each exposed face nor exceed an aggregate gross surface area of two hundred (200) square feet.
- B. Menu board. One (1) on-site menu board per drive-up or walk-up lane of a drive-in restaurant up to a maximum of thirty-two (32) square feet each and a maximum height of three (3) feet. Menu boards are allowed a message on one (1) side only and cannot contain an advertising message.
- C. Directional signs.
 - 1. Directional or instructional signs are permitted in accordance with Section 117-463(I).
 - 2. Parking lot directional signs designating parking area entrances and exits are limited to one (1) sign for each entrance and/or exit and shall not exceed four (4) square feet for each exposed face. Parking lot directional signs shall not project higher than five feet (5') in height, as measured from the established grade of the parking area to which such signs are accessory.
 - 3. Parking lot instructional signs designating the conditions of use or identification parking areas shall not exceed eight (8) square feet and shall not project higher than ten (10) feet in height for wall signs and seven (7) feet in height for ground signs, as measured from the established grade of the parking area to which such signs are accessory.

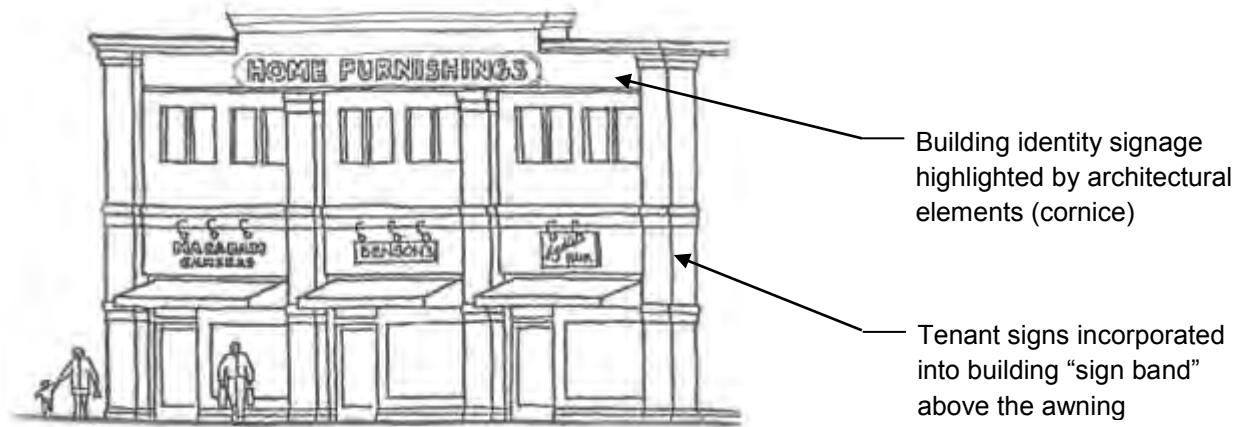

Wall Signs

Wall signs are permitted within all COR sub-districts.

Wall signs shall be permitted on one (1) wall, except that lots with frontage on more than one (1) street may have signage on one (1) wall per street frontage.

Within the COR1, COR3, COR4 and COR5 districts, the following standards apply:

- A. Wall-mounted or painted signs, provided the following standards are met:
 1. The sign shall be affixed to the front facade of the building, and shall project outward from the wall to which it is attached no more than six inches (6").
 2. Single Tenant Buildings. Each building shall be allowed one (1) wall sign per street frontage. Signage must be located on the street elevation. The area of the sign shall not exceed five (5%) percent of the ground floor building facade area or fifty (50) square feet, whichever is less.
 3. Multi-Tenant Buildings.
 - a. Each building shall be allowed wall signage on the street frontage elevation. For buildings with multiple street frontages, the allowable signage is per street frontage. Signage must be located on the street elevation.
 - b. Each building is allowed wall signage that shall not exceed 5% of the wall area of the building façade adjacent to the street or 50 square feet, whichever is less.
 - c. Tenant signage must be located on the tenant lease space.
 - d. At least fifty (50%) percent of the allowed signage must be allocated to ground floor tenants and located on the ground floor.
 - e. Signage is limited to a maximum of one (1) sign per business/tenant, except that tenants with frontage on multiple streets may be permitted to have signage on each street frontage.
 - f. Multi-tenant buildings must have wall signs of similar design. Sign permits for tenants in multi-tenant buildings shall only be permitted by the City after the

building owner has submitted a comprehensive sign plan approved by the Zoning Administrator. The comprehensive sign plan for the building shall include similar design standards including sign material, color, style, spacing and size.

4. Signs for buildings facing Highway 10. Single or multi-tenant buildings that have frontage on Highway 10 or are separated from Highway 10 only by other public right-of-way, shall be allowed to have signage on that street elevation that is up to five (5%) percent of the wall area of that building façade with no maximum square footage.
- B. Wall-mounted building directory signs identifying the occupants of a commercial building, including upper story business uses, provided the following standards are met:
1. The sign is located next to the entrance.
 2. The sign shall project outward from the wall to which it is attached no more than six inches (6").
 3. The sign shall not extend above the parapet, eave, or building facade.
 4. The area of the signboard shall not exceed three (3) square feet, with each tenant limited to one (1) square foot.
 5. The height of the lettering, numbers, or graphics shall not exceed four inches (4").
 6. One (1) such sign is allowed per public building entrance and is allowed in addition to other permitted wall signage.
- C. Applied letters may substitute for wall-mounted signs, if constructed of painted wood, painted cast metal, bronze, brass, acrylic or black anodized aluminum. The height of applied letters shall not exceed 12 inches.
- D. Logos are considered signs and shall be included in the maximum allowable sign area.
- E. Window or door signs, provided that the following standards are met:
1. The sign shall not exceed ten percent of the window or door area or four (4) square feet, whichever is less.
 2. The sign shall be silk screened, hand painted, applied letters/graphics, neon tubing or other sign technologies that meet these standards.
 3. Limited to one (1) sign per business, applied on either the window or the door, but not on both.
 4. The sign shall not have an opaque backing of any type although smoked glass is allowed.

5. Window signage (includes graphics) shall be permitted on the same building walls that have, or are allowed to have, wall signage pursuant to Item A above. Window signage shall be deducted from the allowable wall signage area.

Within the COR2 district, where more conventional suburban development is expected, rather than the neo-traditional development planned for the other COR sub-districts, the following standards apply:

- A. Wall, canopy or marquee sign. Total sign area may not exceed 15 percent of the front building facade. At least 50 percent of the signage area must be placed on the measured wall with remaining signage area, if desired, distributed on any other wall. Sign height shall not exceed the top of the parapet wall or, if no parapet wall, sign height shall not exceed the height of the eaves. The gross surface area of a wall, canopy or marquee sign may be increased by ten percent if such wall sign:
 1. Consists only of individual, outlined alphabetic, numeric and/or symbolic characters without background except that provided by the building surface to which the sign is to be affixed;
 2. Illumination, if any, is achieved through shielded illumination, shielded silhouette lighting, or shielded spot lighting but not any lighting where the light source is visible or exposed on the face or sides of the characters; and
 3. A wall, canopy or marquee sign may be located on the outermost wall of any principle building but shall not project more than 16 inches from the wall to which the sign is to be affixed. A wall sign shall not project higher than the parapet line of the wall to which the sign is to be affixed.
- B. Window signs are restricted to 30 percent of the area of the window in which the sign is to be displayed.

In all COR sub-districts, restaurants and cafes shall be permitted one (1) wall-mounted display featuring the actual menu as used at the dining table, to be contained within a shallow wood or metal case and clearly visible through a glass front. The display case shall be attached to the building wall, next to the main entrance, at a height of approximately five feet (5'), shall not exceed a total area of two square feet, and may be lighted. This signage is allowed in addition to other permitted wall signage.

Projecting Signs

Projecting signs are permitted within all COR sub-districts.

Projecting signs, including graphics or icon signs, mounted perpendicular to the building wall, are encouraged in all sub-districts, provided the following standards are met:

- A. The sign area shall not exceed six (6) square feet.
- B. The distance from the ground to the lower edge of the signboard shall be ten feet or greater.



- C. The height of the top edge of the signboard shall not exceed the height of the wall from which the sign projects, if attached to a single story building, or the height of the sill or bottom of any second story window, if attached to a multistory building.
- D. The distance from the building wall to the signboard shall not exceed six inches (6").
- E. The width of the signboard shall not exceed three (3) feet.
- F. Limited to one (1) sign per business. Projecting sign area shall be deducted from the allowable wall signage area.
- G. Granted to ground floor commercial uses only.

Awning Signs

Awning signs are allowed in all COR sub-districts. Awning signs are allowed for ground floor uses only, provided that the following standards are met:

- A. If acting as the main business sign, it shall not exceed 24 square feet in area, and the height of the lettering, numbers, or graphics shall not exceed 12 inches.
- B. If acting as an auxiliary business sign, it shall be located on the valance only, shall not exceed four (4) square feet in area, and the height of the lettering, numbers, or graphics shall not exceed four inches (4").
- C. Limited to two such signs per business.
- D. If acting as the main business sign, it shall not be in addition to a wall-mounted or applied letter sign.

Sandwich Board Signs

Sandwich board signs are permitted within all COR sub-districts.

- A. One (1) sandwich board sign per business is permitted in any business, commercial and mixed use district and shall be located within five feet (5') of the main building entrance to the business it advertises.
- B. Sandwich board signs shall be displayed only during open business hours and must be removed daily.
- C. Sandwich board signs shall be no more than a total of two feet (2') in width and three feet (3') in height



- D. Sandwich board signs must leave a minimum of five feet (5') of clearance for pedestrian access if placed on a public or private sidewalk. Sandwich board signs may not hinder the ability of persons to access vehicles parked at the curb and/or access to a building.
- E. Acceptable materials for sandwich board signs shall include the following: metal, wood synthetic materials such as a chalk board and whiteboard. Sandwich board signs shall not be illuminated, nor shall they contain moving parts, or have balloons, streamers, stringers, pennants or similar adornments attached to them. Sandwich board signs shall be maintained in a good appearance at all times.
- F. No sandwich board sign shall be secured, tethered or installed on traffic devices, utility equipment, street furniture, street lights, or any other public fixture.
- G. Sandwich board signs are temporary signs and shall not be counted towards the total sign area of the site for permanent signage.

Temporary Signs

Temporary signs are allowed per Section 117-465 (Temporary signs) of the Zoning Ordinance, except as noted below:

- A. Freestanding temporary signs shall only be allowed in the COR1 District.
- B. In all other COR districts, temporary signs shall be limited to temporary sandwich board signs or temporary wall signage.

Off-Site Signs

Off-site signs are prohibited except for wayfinding and community signage specifically allowed by the Design Framework.

Table 2

Sign Standards					
Development Standard	COR1	COR2	COR3	COR4	COR5
Project Signs					
Number of signs allowed	1*	1*	1*	1*	1*
Size of Sign (maximum)	6 sq. ft./6 feet high	100 sq. ft./6 feet high	6 sq. ft./6 feet high	6 sq. ft./6 feet high	6 sq. ft./6 feet high
Menu Board**	N/A	1 per drive-through/36 sq. ft. max.	N/A	N/A	N/A
Directional Sign	N/A	Per 117-463(l)	N/A	N/A	N/A
Wall Sign					
Number of signs allowed	1*	1*	1*	1*	1*
Size of Sign					
Single Tenant Building	50 sq. ft. or 5% of the ground floor façade area, whichever is less	15% of façade area	50 sq. ft. or 5% of the ground floor façade area, whichever is less	50 sq. ft. or 5% of the ground floor façade area, whichever is less	50 sq. ft. or 5% of the ground floor façade area, whichever is less
Multi-Tenant Buildings	50 sq. ft. or 5% of the façade area, whichever is less	15% of façade area	50 sq. ft. or 5% of the façade area, whichever is less	50 sq. ft. or 5% of the façade area, whichever is less	50 sq. ft. or 5% of the façade area, whichever is less
Building Facing Highway 10	5% of the façade area	15% of façade area	5% of the façade area	5% of the façade area	5% of the façade area
Window Sign					
Number of signs allowed	1	1	1	1	1
Size of Sign	10% of area of window or 4 sq. ft., whichever is less. Deducted from allowable wall sign area.	30% of area of window. Deducted from allowable wall sign area.	10% of area of window or 4 sq. ft., whichever is less. Deducted from allowable wall sign area.	10% of area of window or 4 sq. ft., whichever is less. Deducted from allowable wall sign area.	10% of area of window or 4 sq. ft., whichever is less. Deducted from allowable wall sign area.
Directory Sign					
Number of signs allowed	1 per building entrance	1 per building entrance	1 per building entrance	1 per building entrance	1 per building entrance
Size of Sign	3 sq. ft. maximum	3 sq. ft. maximum	3 sq. ft. maximum	3 sq. ft. maximum	3 sq. ft. maximum
Projecting Sign					
Number of signs allowed	1*	1*	1*	1*	1*
Size of Sign	6 sq. ft./3 feet wide	6 sq. ft./3 feet wide	6 sq. ft./3 feet wide	6 sq. ft./3 feet wide	6 sq. ft./3 feet wide
Awning Sign					
Number of signs allowed	2 per business	2 per business	2 per business	2 per business	2 per business
Size of Sign	24 sq. ft./max. letter height 12-inches for main business sign or 4 sq. ft./max letter height 4-inches if auxiliary. Area is deducted from allowable wall sign area.	24 sq. ft./max. letter height 12-inches for main business sign or 4 sq. ft./max letter height 4-inches if auxiliary. Area is deducted from allowable wall sign area.	24 sq. ft./max. letter height 12-inches for main business sign or 4 sq. ft./max letter height 4-inches if auxiliary. Area is deducted from allowable wall sign area.	24 sq. ft./max. letter height 12-inches for main business sign or 4 sq. ft./max letter height 4-inches if auxiliary. Area is deducted from allowable wall sign area.	24 sq. ft./max. letter height 12-inches for main business sign or 4 sq. ft./max letter height 4-inches if auxiliary. Area is deducted from allowable wall sign area.

*One (1) sign is allowed per street frontage (either wall or project)

**Restaurants and cafes in all districts are allowed one (1) wall mounted menu board not to exceed 2 sq. ft. in addition to other permitted wall signage.

Additional standards

- A. Businesses with service entrances may identify these with one (1) wall-mounted or applied letter sign not exceeding two square feet.

- B. One (1) directional sign, facing a rear parking lot. This sign may be any type of permitted sign other than a freestanding sign, but shall be limited to four (4) square feet in area.

Creative Sign Standards

- A. *Purpose.* This section establishes standards and procedures for the design, review, and approval of creative signs. The purposes of this creative sign program are to:
 - 1. Encourage signs of unique design, and that exhibit a high degree of thoughtfulness, imagination, inventiveness, and spirit; and
 - 2. Provide a process for the application of sign regulations in ways that will allow creatively designed signs that make a positive visual contribution to the overall image of the city, while mitigating the impacts of large or unusually designed signs.
- B. *Applicability.* An applicant may request approval of a sign permit for a creative sign to authorize onsite signs that employ standards that differ from the other provisions of this chapter but comply with the provisions of this section.
- C. *Application Requirements.* A sign permit application for a creative sign shall include all information and materials required by the City.
- D. *Procedure.* A sign permit application for a creative sign shall be subject to review and approval by the City as part of the Site Plan review process. When the creative sign is proposed after site plan review is complete, a creative sign may be approved by the Zoning Administrator when the proposed sign is fifty square feet or less, and shall be approved by the City Council when the sign is larger than fifty square feet.
- E. *Design Criteria.* In approving an application for a creative sign, the review authority shall ensure that a proposed sign meets the following design criteria:
 - 1. Design Quality. The sign shall:
 - a. Constitute a substantial aesthetic improvement to the site and shall have a positive visual impact on the surrounding area;
 - b. Be of unique design, and exhibit a high degree of thoughtfulness, imagination, inventiveness, and spirit; and
 - c. Provide strong graphic character through the imaginative use of graphics, color, texture, quality materials, scale, and proportion.
 - 2. Contextual Criteria. The sign shall contain at least one (1) of the following elements:
 - a. Classic historic design style;
 - b. Creative image reflecting current or historic character of the City;
 - c. Inventive representation of the use, name, or logo of the structure or business.

3. Architectural Criteria. The sign shall:
 - a. Utilize or enhance the architectural elements of the building; and
 - b. Be placed in a logical location in relation to the overall composition of the building's façade and not cover any key architectural features and details of the façade.
4. Neighborhood Impacts. The sign shall be located and designed not to cause light and glare impacts on neighboring residential uses.

Prohibited signs

The following signs are prohibited:

- A. Box signs or cabinet signs, whether on a wall, projecting or on canopies are prohibited except for logo signs permitted as part of an overall sign plan.
- B. Signs employing mercury vapor, low pressure and high pressure sodium and metal halide lighting; plastic panel rear-lighted signs.
- C. Signs on roofs, dormers, and balconies.
- D. Billboards.
- E. Signs painted or mounted upon the exterior side or rear walls on any principle or accessory building or structure, except as otherwise permitted hereunder.
- F. Free standing pylon signs over six (6) feet in height, except community signs.
- G. Back-lit awnings.
- H. Interchangeable letter boards or panels.
- I. Flashing signs.
- J. Off-premises signs, except community signs.

Overall Framework – Stormwater Management

Overview

Water features and drainage systems are essential components of The COR Master Plan. The mix of ponds, streams, fountains and other water elements will provide focal amenities and year round activities within the framework of an environmentally responsible, visually pleasing strategy to manage stormwater. Because the Mississippi River is a restricted discharge water of the state, and because we are creating a new discharge from this development, each sub-district and each site has a responsibility to utilize ‘best management practices’ (BMP) to pretreat run-off, reduce erosion and encourage infiltration, with the understanding that regional treatment will be provided. Water elements are not intended to be separate stand-alone features, but instead should be integrated with the variety of parks, trails and public open space proposed for The COR. Water and landscape should be designed and utilized within multipurpose areas that accommodate both active and passive recreational use.

Objectives

Integration of water and landscape, design creativity, use of high quality materials and safety concerns are the critical objectives to be met – the following examples illustrate only a few of many possibilities:

- Innovative new products, such as special soil systems (Netlon, structural soils), pervious pavements for parking areas, storm ceptors, underground storage and other creative techniques should be used to BMP standards
- ‘Green architecture’, expressed through green roofs, gray water recycling and other techniques should be included to reduce the impact of new development on stormwater systems
- Water feature design should include both formal elements (such as reflecting pools or fountains) and natural/informal forms (such as ponds, streams, waterfalls) and should explore creative ways to integrate wetland/rain garden landscapes with active, urban spaces.



Guideline Recommendations

This framework not only defines the overall role and character of The COR, but also encourages each development parcel to address the following:

- **Create** signature water features (ponds, pools, fountains, waterfalls, etc.) as major visual amenities throughout The COR
- **Promote** high quality, creative and appealing aesthetics for all system elements
- **Integrate** stormwater management components (meeting both water quality and quantity requirements)

A great deal of time and effort has gone into the calculation and design of a 'watershed-based' stormwater management plan to support COR development. While this overall strategy addresses the water quantity issue for the entire COR by providing storage and conveyance facilities for storm events, individual development projects (block-by-block) have an equal responsibility to meet water quality standards as a primary goal. Each project should integrate a variety of techniques, materials and methods to promote multiple use, maximum flexibility, improved aesthetics for parking areas, park spaces, drainage swales and other site features.

Overall Framework – Parks/Public Spaces

Overview

The overall design framework of The COR is based on a system of linked parks, trails and open space. The City of Ramsey, Anoka County, and to some extent, the State of Minnesota all play a role in local and regional parks programming, design review, construction sequencing, implementation and ultimately maintenance and operation of key public spaces within this framework. The goal is to link existing and proposed parks and trails defined in regional park plans with proposed new parks and trails within The COR. Of equal importance is the contribution from each block and each development project to this network of green, adding a variety of private, semi-private, and perhaps some additional public space throughout The COR. Private development will share the responsibility to provide inviting, innovative and useable green space as integral parts of individual parcel site design.

Guideline Recommendations

The Design Framework encourages the following:

- Work with the City to create an integrated, comprehensive open space system that links with existing city and county trails and open space networks
- Encourage private development (block-by-block) to share in the responsibility to provide inviting, innovative and useable green space as integral parts of each development project
- Integrate stormwater management components (meeting water quality and quantity requirements) within both public / private park and open space improvements



Together, the system of public and semi-public green space will result in a welcoming public realm throughout the new community.

Objectives

Based on the Development Master Plan for The COR, a variety of public and private green space is proposed including:

- Each block and each project will provide intentional, creative, innovative, useable green areas as integral components of site development and building design.
- At the individual block scale, small squares and greens will provide places for gathering and relaxation, especially targeted to meet the demands of adjacent, or nearby buildings. Elements such as gardens, gazebos and fountains should characterize these more intimate public spaces.
- At the neighborhood scale, parks will provide space for more active recreation, and should be flexible enough to accommodate a variety of recreational activities.
- Playgrounds, game fields and park buildings are park amenities that will target a wider user demand from the surrounding community.
- The Municipal Plaza will connect with all other parks and open space elements, providing a focal point for activity and a sense of place. Gardens, public pavilions and shelters, play lots and open play fields are amenities that will provide built-in flexibility to meet the demands of both the local population and regional visitors to The COR.



Part Two: Sub-district Framework

Overview

The Master Plan and Zoning Ordinance identify five (5) distinct sub-districts within The COR. Each of these sub-districts is defined by a unique mix of uses, specific site development patterns and perhaps a distinctive character or image. The sub-districts complement one another as part of the overall plan. The sub-districts are shown the attached Sub-district Map (Figure 7: Sub-district Map). They include:

- **COR1 Mixed Use Core** – provides the broadest variety, highest density and greatest intensity of development, encouraging both vertical and horizontal mixed use
- **COR2 Commercial** – provides a location for larger scale retail and other auto-orientated commercial uses
- **COR3 Workplace** – provides a location for uses with high concentrations of employees, such as medical/technology related office, and other corporate or institutional uses
- **COR4 Neighborhood** – provides opportunities for a range of housing types from small lot single family to townhouse, to high density senior or rental apartment
- **COR5 Park and Open Space** – preserves environmental features and provides neighborhood/community amenities throughout The COR

Development plans must respond to the overall COR Design Framework described in Part One of this document, but also must address the following detailed framework standards for each sub-district. To further clarify and illustrate proposed features in the Master Plan, these sub-district guidelines are organized under the following categories:

- Public Realm / Streetscape Framework
- Site Design Framework
- Architectural Framework

In all cases, the sub-district framework must be applied in harmony with the overall COR framework and with other existing city, county, state codes, design criteria, plans and studies that support broader goals for regional growth and development. However, within each district, development standards shall be based, in part, on the street hierarchy established in The COR.

Public Realm/Streetscape

- A. The developer shall be responsible for construction of all streetscape improvements along adjacent streets. These improvements include all hardscape improvements, such as trails, sidewalks, benches, bike racks, etc., as well as street trees and other greenscape.
- B. The landowner shall be responsible for maintenance of the streetscape improvements along adjacent streets. Such maintenance may be managed as part of a Special Service District (SSD) or similar.

Plazas

- A. All properties with principal buildings in excess of 30,000 square feet shall be required to have a public plaza space.
- B. The public plaza space shall include benches, bike racks trash receptacles, lighting fixtures and other amenities to create a welcoming space for tenants of the building and members of the public.

C. These plaza spaces should be visible from the public street.

Architecture

These architectural framework standards provide an important balance between design continuity, desirable variety and the notion that buildings should complement, and perhaps contrast, but not compete with one another. The lasting appeal of the final outcome must be grounded in the authenticity of the design and the acceptable level of ‘messiness’ that comes with creating a real downtown over time; ‘faux’ second floors, stage set or themed solutions, and large faceless buildings are not acceptable.



Auto Versus Human Design: Providing rear alleys or side loaded garages enables the home to present itself to the street, which promotes sociability and walkability.

Minimum Standards

Definitions

Build to line: The line at which construction of a building facade is to occur on a lot. The build to line provides a maximum setback for all building facades from the right-of-way or inside edge of the sidewalk, whichever is greater. The build to line applies to all facades abutting a street right of way. Build to line standards are based on the sub-district the parcel is located and the street in which the building is located upon.

Setback: The minimum required distance between a parking lot or the vertical wall of a building and a lot line. Setbacks are typically more flexible than build to lines and allow a building to be set further back from the lot line and street right-of-way.

Requirements:

- A. Additional development standards shall be defined within each sub-district.
- B. Provide a diverse mix of materials, applied in a variety of proportions, exposures and detailing within a block, or along a street.

C. Buildings should be articulated to break up the mass of the building façade on all elevations. Large blank exterior walls shall be prohibited. Windows are encouraged to be used to break up the mass of the building. Rooflines and building elevations should be articulated to break up the mass of buildings. Buildings must be broken at a minimum of every fifty (50) feet. This variation can be accomplished through one (1) or more of the following:

1. Wall face variations (minimum depth of two (2) feet)
2. Pilasters or columns (minimum depth of two (2) feet)
3. Upper wall break in color and/or materials (minimum of 2/3 up the height of the wall)
4. Wainscot (minimum of four (4) feet high)
5. Canopies (minimum four (4) foot width)
6. Corner and demising wall or building separations



More Desirable

D. Each development application must list building materials, roofing materials and building colors on the plans. Building articulation, mechanical screening by architectural elements and design elements on all building elevations must be identified on the plans. The plans shall be subject to City review and approval to ensure that the design intent of the Framework has been met.



Less Desirable

E. Building materials shall be high-quality durable materials, such as glass, stone, brick, windows, canvas awnings, etc.

1. Use local sources if available
2. Siding is not allowed (vinyl, metal, wood) except as a complimentary use
3. Use clear or lightly tinted glass for all windows and doors – mirrored, reflective or highly tinted glazing is not acceptable
4. Metal and wood components are acceptable as a complimentary, not primary, building material
5. COR1 sub-district buildings shall be primarily brick or a comparable alternative and shall comprise a minimum of fifty (50%) percent of the non-glazed wall area

F. Residential development should provide variety within the subdivision to avoid monotony. Developers will include front porches and windows that face all streets. Corner units shall have more than one (1) window per side of building to help create a sense of place in the community and promote safety on the street.

G. Garage forward or “snout houses” are highly discouraged on all residential development as they dominate the view from the street and sidewalk.

H. All sides of buildings shall have an equal finish in terms of materials and general design.

I. The main entrance of each principal building must face the street. On corner lots, the main entrance may face either of the streets or be oriented to the corner. With buildings that have more than one (1) main entrance, only one (1) entrance must meet this requirement.

- J. Building massing shall be oriented parallel to the street frontage of the lot.
- K. Trash and recycling areas shall be designed internal to the building.
- L. Provide recessed entries wherever possible.
- M. Buildings shall have a base and top to the architecture.
- N. Multi-story buildings are preferred in the COR1 sub-district, but occasional single story buildings are acceptable; single story buildings should not dominate any street frontage and should be a minimum of twenty (20) feet to the roofline.
- O. Maximize glass openings for all ground level, street front façades – especially for retail, restaurant and other commercial uses – fifty (50%) minimum of total ground level façade, or demonstrate great design through other means.
- P. Provide real window openings for all street facing façades above ground level in all districts—a minimum of forty (40%) percent of total façade.



Residential uses in COR4 and COR5 must also comply with the following:

- A. *Location of main entrance*
 1. A building must include a front porch or covered balcony/patio at all main entrances that face a street. The porch or stoop shall adjoin the main entrance and the main entrance shall be accessible from the porch.
 2. The main entrance of each principal building must face the street. On corner lots, the main entrance may face either of the streets or be oriented to the corner. With buildings that have more than one (1) main entrance, only one (1) entrance must meet this requirement.
- B. *Porches:* Porches used to satisfy the design criteria shall comply with the following:
 1. Porches shall be covered by a solid roof. The roof shall not be located more than 12 feet above the floor of the porch. If the roof of a required porch is developed as a deck or balcony, it may be flat.
 2. The porch shall have minimum dimensions of 6 feet by 6 feet. (6' x 6'). For single-family detached dwelling units, the covered area provided by the porch must be at least



forty-eight (48) square feet and a minimum of eight (8) feet wide. If the main entrance is for more than one (1) dwelling unit, the covered area provided by the porch must be at least sixty-three (63) square feet and a minimum of nine (9) feet wide.



C. *Covered balconies/patio*: The covered area must be at least forty-eight (48) square feet, a minimum of eight (8) feet wide, and no more than fifteen (15) feet above grade. The covered area must be accessible from the interior living space of the house.

D. *Openings between porch floor and ground*: Openings of more than one (1) foot between the porch floor and the ground must be covered with a solid material or lattice.

E. *Roofs*

1. *Slope*: Principal structures must have a roof that is sloped, with a pitch that is no flatter than six (6) units of horizontal run to twelve (12) units of horizontal rise.
2. *Architectural features*: The roof of a principal structure shall include the following architectural details:
 - a. At least one (1) dormer facing the street. If only one (1) dormer is included, it shall be at least five (5) feet wide and shall be centered horizontally between each end of the front elevation. If more than one (1) dormer is provided, a dormer at least four (4) feet wide must be provided on each side of the front elevation;
or
 - b. A gabled end, or a gabled end of a roof projection, facing the street.
3. *Roof eaves*: Roof eaves must project from the building wall at least twelve (12) inches, measured horizontally, on at least the front and side elevations.



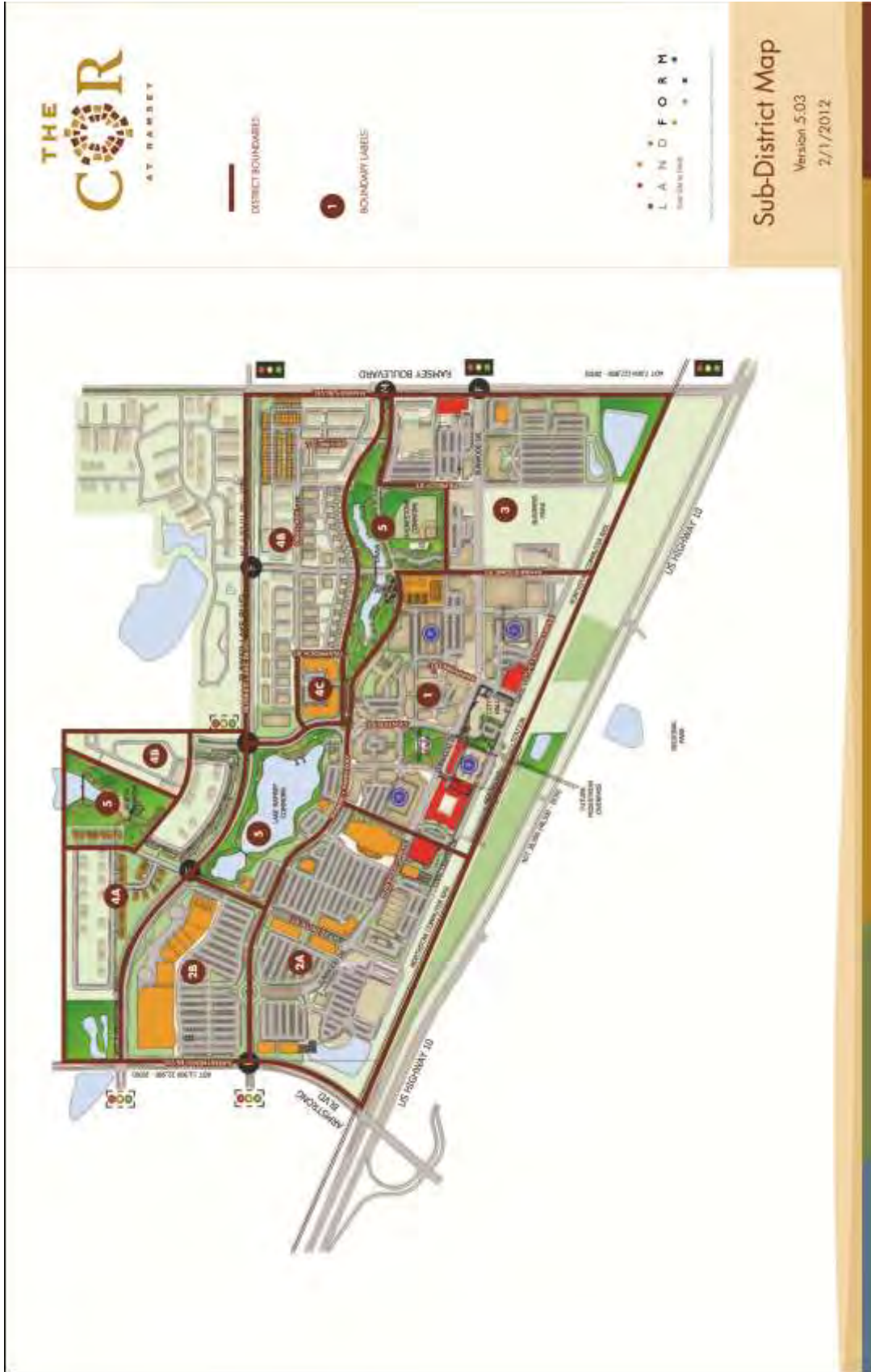

Figure 7: Sub-district Map

Sub-District Framework - COR1 Mixed Use Core

Public Realm / Streetscape

Public realm and streetscape improvements define the character of The COR and create a memorable signature for the Mixed Use Core sub-district. This is the most urban of all sub-districts in The COR and will be developed with a very urban pattern. Great parks and great streets, encourage intensified levels of activity, support the proposed mix of uses, invite community gathering and accommodate special events throughout the year.

Site Development

Framework standards that address building location, organization of space and parking options tend to focus on what can be measured – dimensions, setbacks, number of spaces and so on. But in addition to these issues, the Design Framework also describes the aesthetic qualities and design character of a preferred ‘urban form’ for the Mixed Use Core. The compact and higher density blocks that define this sub-district encourage a mix of uses, with a continuous built edge along street frontage. Innovative parking strategies support this mix, providing easy access to destination shopping, restaurant and entertainment venues. Together these elements will promote the core area as the center of activity – the place to see and be seen within The COR.

Architecture

Buildings in the Mixed Use Core will play a major role in defining the overall character of The COR. The proposed mix of uses for this signature destination suggests the potential for a variety of building types, demanding creativity and innovation to highlight unique architecture, while knitting the entire sub-district together as a coherent whole. Overall building design is an important consideration, but emphasis on first floor façade treatments is essential to encourage street-level activity and enhance the pedestrian experience. Architecture to be ‘4-sided’ at all locations visible to public areas. Emphasis will be on great design along public street frontage.

Table 3

COR1 Development Standards						
	Arterial Street	Destination Street	Parkway	Connector Street	Downtown Street	Local Street
Minimum lot size	None	None	None	None	None	None
Minimum lot width	20 feet	20 feet	20 feet	20 feet	20 feet	20 feet
Minimum lot depth	80 feet	80 feet	80 feet	80 feet	80 feet	80 feet
Allowable residential density in dwelling units per acre ⁽¹⁾	>15 DU/AC	>15 DU/AC	>15 DU/AC	>15 DU/AC	>15 DU/AC	>15 DU/AC
Minimum floor area ratio (FAR) for nonresidential uses/vertically mixed buildings/sites	.75	.75	.75	.75	.75	.75
Build to Line						
Front yard ⁽⁴⁾	30 feet as measured from building front to right-of-way ⁽²⁾⁽³⁾ (60% of front facade w/in max.)	5 feet as measured from building front to right-of-way ⁽²⁾ (60% of front facade w/in max.)	5 feet as measured from building front to right-of-way ⁽²⁾ (60% of front facade w/in max.)	5 feet as measured from building front to right-of-way ⁽²⁾ (60% of front facade w/in max.)	5 feet as measured from building front to right-of-way ⁽²⁾ (60% of front facade w/in max.)	5 feet as measured from building front to right-of-way ⁽²⁾ (60% of front facade w/in max.)
Side yard	no req.	no req.	no req.	no req.	no req.	no req.
Rear yard	no req.	no req.	no req.	no req.	no req.	no req.
Driveway length (minimum)	25 feet for residential units	25 feet for residential units	25 feet for residential units	25 feet for residential units	25 feet for residential units	25 feet for residential units
Building height (min. - max.)	2 - 5 stories.	2 - 5 stories.	2 - 5 stories.	2 - 5 stories.	2 - 5 stories.	2 - 5 stories.
Planter Style	N/A	Planter Bed	Boulevard Sod	Boulevard Sod	N/A	Boulevard Sod
Tree Spacing (on center)	N/A	35 feet	35 feet	35 feet	35 feet	35 feet
Boulevard Width	N/A	6 feet	6 feet	6 feet	N/A	6 feet
Sidewalk Width	10 feet	10 feet	6 feet	10 feet	10 feet	10 feet

1. Residential density is based on the net area of the parcel in question for parcels. In the event that public open space that is not dedicated to the City is developed independently of any particular residential project, the land area of the open space shall be divided equally among those abutting projects for purposes of density calculations.
2. Build to line shall be measured from building front to edge of right-of-way, or edge of sidewalk easement as defined by the City and said sidewalk must be encumbered by a sidewalk easement recorded with the office of the Anoka County Recorder.
3. The City may approve up to a 60-foot setback if it finds that topography or other factors require that a building be set back further to achieve acceptable grades or buffer between the street, the site entrance and the building.
4. In order to address vision clearance standards on higher speed roadways, parcels that are located at an intersection with an arterial roadway are allowed a build-to line of 35 feet from both streets.

A. At least sixty (60%) percent of street frontage of any lot shall be occupied by building facades meeting this build-to-line. On lots with more than one (1) street frontage, the build to line shall apply on each side fronting a street. An enclosed open area plaza space or outdoor seating with a decorative wall with a minimum height of three feet (3') and a maximum of four and one-half feet (4 ½') can be used to meet the sixty (60%) percent street frontage requirement.

B. Screening Of Parking Areas: Wherever a surface parking area faces a street frontage, such frontage shall be screened with a decorative wall, railing, hedge, or a combination of these elements, to a minimum height of three feet (3') and a maximum height of four and one-half feet (4 ½') above the level of the parking lot, at the build-to line. This screening may be broken into sections along the street edge provided it meets the sixty (60%) percent required.

Sub-District Framework - COR2 Commercial

Public Realm / Streetscape

While the Commercial Sub-district encourages a mix of large and small floor plates accommodating auto-oriented uses, this suggests even greater attention be paid to public realm and streetscape improvements that not only accommodate vehicles, but also invite bicycle and pedestrian traffic. Surface parking lots provide convenient access to storefronts, but present an additional challenge to the overall visual character and aesthetic appeal of this area. While no large public parks are identified for this sub-district, small pocket parks, squares or other gathering spaces are encouraged. A consistent, attractive streetscape is also essential.

Site Development

Site Design Framework for this sub-district focus on a unique opportunity to recast typical commercial development patterns into a contemporary and innovative strategy that responds to overall objectives for The COR. Specifically, this suggests that the majority of buildings front on the primary through streets, with parking and service areas on the side or in the back, away from view. However, the market realities suggest that the types of auto-oriented users in this district will have the potential for larger parking fields and drive-throughs that will make a true urban model challenging. The City will hold all users to this design vision while modifying the COR2 standards slightly to accommodate these types of more typical suburban land uses. A mix of uses within individual blocks, including retail, restaurant and residential, further enhances this model, addresses design character/aesthetics and promotes activity throughout much of the day and evening hours.

Architecture

Buildings in the Commercial Sub-district make a significant contribution to first impressions of The COR. Buildings form gateways at the major entries into the site, architectural elements and choice of materials convey a certain character and the scale or massing of structures begins to define the feel or experience of this place. These are not just 'commodity' buildings, but instead should raise the bar in terms of overall design and specific details that make The COR unique, inviting and memorable. Architecture to be '4-sided' at all locations visible to public areas. Emphasis will be on great design along public street frontage.

Table 4

COR2 Development Standards						
	Arterial Street	Destination Street	Parkway	Connector Street	Downtown Street	Local Street
Minimum lot size	None	None	None	None	None	None
Minimum lot width	80 feet	80 feet	80 feet	80 feet	80 feet	80 feet
Minimum lot depth	100 feet	100 feet	100 feet	100 feet	100 feet	100 feet
Allowable residential density in dwelling units per acre ⁽¹⁾	>15 DU/AC	>15 DU/AC	>15 DU/AC	>15 DU/AC	>15 DU/AC	>15 DU/AC
Build to Line						
Front yard ⁽⁴⁾	30 feet as measured from building front to right-of-way ⁽²⁾⁽³⁾ (40% of front facade w/in max.)	15 feet as measured from building front to right-of-way ⁽²⁾ (40% of front facade w/in max.)	30 feet as measured from building front to right-of-way ⁽²⁾⁽³⁾ (40% of front facade w/in max.)	15 feet as measured from building front to right-of-way ⁽²⁾ (40% of front facade w/in max.)	15 feet as measured from building front to right-of-way ⁽²⁾ (40% of front facade w/in max.)	15 feet as measured from building front to right-of-way ⁽²⁾ (40% of front facade w/in max.)
Side yard	no req.	no req.	no req.	no req.	no req.	no req.
Rear yard	no req.	no req.	no req.	no req.	no req.	no req.
Driveway length (minimum)	25 feet for residential units	25 feet for residential units	25 feet for residential units	25 feet for residential units	25 feet for residential units	25 feet for residential units
Building height (min. - max.)	1-4 stories.	1-4 stories.	1-4 stories.	1-4 stories.	1-4 stories.	1-4 stories.
Planter Style	N/A	Boulevard Sod	Boulevard Sod	Boulevard Sod	N/A	Boulevard Sod
Tree Spacing (on center)	N/A	35 feet	35 feet	35 feet	35 feet	35 feet
Boulevard Width	N/A	6 feet	6 feet	6 feet	N/A	6 feet
Sidewalk Width	10 feet	6 feet	6 feet	10 feet	10 feet	10 feet

1. Residential density is based on the net area of the parcel in question for parcels. In the event that public open space that is not dedicated to the City is developed independently of any particular residential project, the land area of the open space shall be divided equally among those abutting projects for purposes of density calculations.
2. Build to line shall be measured from building front to edge of right-of-way, or edge of sidewalk easement as defined by the City and said sidewalk must be encumbered by a sidewalk easement recorded with the office of the Anoka County Recorder.
3. The City may approve up to a 60-foot setback if it finds that topography or other factors require that a building be set back further to achieve acceptable grades or buffer between the street, the site entrance and the building.
4. In order to address vision clearance standards on higher speed roadways, parcels that are located at an intersection with an arterial roadway are allowed a build-to line of 35 feet from both streets.

- A. At least forty (40%) percent of street frontage of any lot shall be occupied by building facades meeting this build-to-line. On lots with more than one (1) street frontage, the build to line shall apply only to one (1) street frontage.
 1. An enclosed open area plaza space or outdoor seating with a decorative wall with a minimum height of three feet (3') and a maximum of four and one-half feet (4 ½') can be used to meet the forty (40%) percent street frontage requirement.
 2. The City may approve a variation from the required build to line if the applicant provides a street edge consisting of fencing, decorative wall and/or landscaping with a minimum height of three feet (3') and a maximum of four and one-half feet (4 ½') can be used to meet the forty (40%) percent street frontage requirement.
- B. Screening Of Parking Areas: Wherever a surface parking area faces a street frontage, such frontage shall be screened with a decorative wall, railing, hedge, or a combination of these elements, to a minimum height of three feet (3') and a maximum height of four and one-half feet (4 ½') above the

level of the parking lot, at the build-to line. This screening may be broken into sections along the street edge provided it meets the forty (40%) percent required on all street frontages.

Sub-District Framework - COR3 Workplace

Public Realm/Streetscape

The Workplace Sub-district also encourages a mix of large and small floor plate buildings, but instead of commercial or entertainment, this area of The COR is dominated by office and institutional uses. With opportunities for corporate or medical campus development comes the attendant auto-related infrastructure – easy access, bigger streets and large surface parking lots. Once again, this suggests that equal attention be paid to public realm and streetscape improvements that not only accommodate vehicles, but also invite bicycle and pedestrian traffic. The Draw, an active, neighborhood scale, recreational play space has been included in this sub-district, but small pocket parks, squares or other gathering places are also encouraged. In addition, streetscape improvements provide an important public amenity and inviting pedestrian connection to adjacent sub-districts.

Site Development

The mix of medical, office, institutional and other uses in this sub-district suggest the potential for a campus-like arrangement of buildings on some blocks. These blocks would tend to be more internally oriented than in other districts, with driveways, parking lots, courtyards and walkway connections in the center, ringed by buildings around the outside. Buildings would still face adjacent streets, with both primary and secondary entries provided to animate these important façades, particularly along Ramsey Boulevard, Sunwood Drive and Rhinestone Street. While the Workplace sub-district also encourages mixed use, this desired development objective will likely occur mostly within blocks, not within individual buildings as seen in other districts.

Architecture

Buildings in the Workplace Sub-district also make a significant contribution to first impressions as people enter The COR via Highway 10, Ramsey Boulevard and Sunwood Drive. Buildings form gateways at the major entries into the site, architectural elements and choice of materials convey quality and permanence, and the scale or massing of structures begins to define the feel and character of this place. The proposed mix of uses within this sub-district suggest a variety of potential building types – blending medical campus with small office, storefront and some housing -- demands design creativity and innovation to highlight unique architecture, and knit the entire sub-district together as a coherent whole. Architecture to be '4-sided' at all locations visible to public areas. Emphasis will be on great design along public street frontage.

Table 5

COR3 Development Standards						
	Arterial Street	Destination Street	Parkway	Connector Street	Downtown Street	Local Street
Minimum lot size	None	None	None	None	None	None
Minimum lot width	40 feet	40 feet	40 feet	40 feet	40 feet	40 feet
Minimum lot depth	80 feet	80 feet	80 feet	80 feet	80 feet	80 feet
Allowable residential density in dwelling units per acre ⁽¹⁾	none	none	none	none	none	none
Minimum floor area ratio (FAR) for nonresidential uses/vertically mixed buildings/sites	.25	.25	.25	.25	.25	.25
Build to Line						
Front yard ⁽⁴⁾	30 feet as measured from building front to right-of-way ⁽²⁾⁽³⁾ (60% of front facade w/in max.)	15 feet as measured from building front to right-of-way ⁽²⁾ (60% of front facade w/in max.)	15 feet as measured from building front to right-of-way ⁽²⁾ (60% of front facade w/in max.)	15 feet as measured from building front to right-of-way ⁽²⁾ (60% of front facade w/in max.)	15 feet as measured from building front to right-of-way ⁽²⁾ (60% of front facade w/in max.)	15 feet as measured from building front to right-of-way ⁽²⁾ (60% of front facade w/in max.)
Side yard	no req.	no req.	no req.	no req.	no req.	no req.
Rear yard	no req.	no req.	no req.	no req.	no req.	no req.
Driveway length (minimum)	25 feet for residential units	25 feet for residential units	25 feet for residential units	25 feet for residential units	25 feet for residential units	25 feet for residential units
Building height (min. - max.)	2 - 4 stories.	2 - 4 stories.	2 - 4 stories.	2 - 4 stories.	2 - 4 stories.	2 - 4 stories.
Planter Style	N/A	Planter Bed	Boulevard Sod	Boulevard Sod	N/A	Boulevard Sod
Tree Spacing (on center)	N/A	35 feet	35 feet	35 feet	35 feet	35 feet
Boulevard Width	N/A	6 feet	6 feet	6 feet	N/A	6 feet
Sidewalk Width	10 feet	10 feet	6 feet	10 feet	10 feet	10 feet

1. Residential density is based on the net area of the parcel in question for parcels. In the event that public open space that is not dedicated to the City is developed independently of any particular residential project, the land area of the open space shall be divided equally among those abutting projects for purposes of density calculations.
2. Build to line shall be measured from building front to edge of right-of-way, or edge of sidewalk easement as defined by the City and said sidewalk must be encumbered by a sidewalk easement recorded with the office of the Anoka County Recorder.
3. The City may approve up to a 60-foot setback if it finds that topography or other factors require that a building be set back further to achieve acceptable grades or buffer between the street, the site entrance and the building.
4. In order to address vision clearance standards on higher speed roadways, parcels that are located at an intersection with an arterial roadway are allowed a build-to line of 35 feet from both streets.

A. At least sixty (60%) percent of street frontage of any lot shall be occupied by building facades meeting this build-to-line. On lots with more than one (1) street frontage, the build to line shall apply on each side fronting a street. An enclosed open area plaza space or outdoor seating with a decorative wall with a minimum height of three feet (3') and a maximum of four and one-half feet (4 ½') can be used to meet the sixty (60%) percent street frontage requirement.

B. Screening Of Parking Areas: Wherever a surface parking area faces a street frontage, such frontage shall be screened with a decorative wall, railing, hedge, or a combination of these elements, to a minimum height of three feet (3') and a maximum height of four and one-half feet (4 ½') above the level of the parking lot, at the build-to line. This screening may be broken into sections along the street edge provided it meets the sixty (60%) percent required.

Sub-District Framework - COR4 Neighborhood

Public Realm/Streetscape

Two prominent public parks supply much of the informal green space for The COR, and more specifically, provide the valuable park frontage and mix of amenities needed to support housing development within the Neighborhood Sub-district. North Commons surrounds an existing wetland and provides open space for year-round activities including a proposed sledding hill. The sub-district is adjacent to The Draw, which is characterized by wetlands, ponds and a meandering stream channel surrounded by gently sloping hills. Other park features include active and passive recreation areas, natural and manicured landscapes, education and interpretation opportunities, pedestrian and bicycle trails and many other amenities. Tree-lined streets connect these parks to surrounding residential neighborhoods and to nearby parks and amenities throughout The COR.

Site Development

The Neighborhood Sub-district emphasizes residential development. To support the proposed mix of housing, a framework of streets and blocks, based on the traditional grid system, encourages compact development patterns with increasing densities closer to the heart of The COR. Typical blocks either front onto signature parks or include some private green space within the site; many blocks have both. The arterial streets that frame this property, including Ramsey, Armstrong and Bunker Lake Boulevards, provide an important 'face' for this sub-district. Residential front doors will connect with public walks along each of these streets promoting the urban character of The COR.

Architecture

The largest in terms of overall acreage, the Neighborhood Sub-district will define the character and quality of the entire northern half of The COR property. With prominent street frontage along most of the major thoroughfares that serve this site, the variety of choices for building type, architectural style and design detailing are crucial decisions that together will promote a safe and attractive residential neighborhood. Integrating contemporary and traditional styles is also an important consideration, central to the notion that a unique and creative model for housing development will be a signature for The COR. Architecture to be '4-sided' at all locations visible to public areas. Emphasis will be on great design along public street frontage.

Table 6

COR4 Development Standards						
	Arterial Street	Destination Street	Parkway	Connector Street	Downtown Street	Local Street
Minimum lot size	None	None	None	None	None	None
Minimum lot width	20 feet	20 feet	20 feet	20 feet	20 feet	20 feet
Minimum lot depth	80 feet	80 feet	80 feet	80 feet	80 feet	80 feet
Allowable residential density in dwelling units per acre ⁽¹⁾	4-15 DU/AC	4-15 DU/AC	4-15 DU/AC	4-15 DU/AC	4-15 DU/AC	4-15 DU/AC
Minimum floor area ratio (FAR) for nonresidential uses/vertically mixed buildings/sites	.25	.25	.25	.25	.25	.25
Build to Line						
Front yard ⁽⁴⁾	30 feet as measured from building front to right-of-way ⁽²⁾⁽³⁾ (60% of front facade w/in max.)	20 feet as measured from building front to right-of-way ⁽²⁾ (60% of front facade w/in max.)	20 feet as measured from building front to right-of-way ⁽²⁾ (60% of front facade w/in max.)	20 feet as measured from building front to right-of-way ⁽²⁾ (60% of front facade w/in max.)	20 feet as measured from building front to right-of-way ⁽²⁾ (60% of front facade w/in max.)	20 feet as measured from building front to right-of-way ⁽²⁾ (60% of front facade w/in max.)
Side yard	no req.	no req.	no req.	no req.	no req.	no req.
Rear yard	no req.	no req.	no req.	no req.	no req.	no req.
Driveway length (minimum)	25 feet for residential units	25 feet for residential units	25 feet for residential units	25 feet for residential units	25 feet for residential units	25 feet for residential units
Building height (min. - max.)	1-4 stories.	1-4 stories.	1-4 stories.	1-4 stories.	1-4 stories.	1-4 stories.
Planter Style	N/A	Planter Bed	Boulevard Sod	Boulevard Sod	N/A	Boulevard Sod
Tree Spacing (on center)	N/A	35 feet	35 feet	35 feet	35 feet	35 feet
Boulevard Width	N/A	6 feet	6 feet	6 feet	N/A	6 feet
Sidewalk Width	10 feet	10 feet	6 feet	10 feet	10 feet	10 feet

1. Residential density is based on the net area of the parcel in question for parcels. In the event that public open space that is not dedicated to the City is developed independently of any particular residential project, the land area of the open space shall be divided equally among those abutting projects for purposes of density calculations.
2. Build to line shall be measured from building front to edge of right-of-way, or edge of sidewalk easement as defined by the City and said sidewalk must be encumbered by a sidewalk easement recorded with the office of the Anoka County Recorder.
3. The City may approve up to a 60-foot setback if it finds that topography or other factors require that a building be set back further to achieve acceptable grades or buffer between the street, the site entrance and the building.
4. In order to address vision clearance standards on higher speed roadways, parcels that are located at an intersection with an arterial roadway are allowed a build-to line of 35 feet from both streets.

A. Screening Of Parking Areas: Wherever a surface parking area faces a street frontage, such frontage shall be screened with a decorative wall, railing, hedge, or a combination of these elements, to a minimum height of three feet (3') and a maximum height of four and one-half feet (4½') above the level of the parking lot, at the build-to line. This screening may be broken into sections along the street edge provided it meets the sixty (60%) percent required.

Sub-District Framework - COR5 Parks & Open Space

Public Realm/Streetscape

The overall structure of The COR is based on a system of linked parks, trails and open space. This includes existing and proposed parks and trails defined in city and regional parks plans, joined with new parks and trails within The COR. Of equal importance is the contribution from each block and each development project to this green structure, adding a variety of private, semi-private and perhaps some additional public space throughout each sub-district. Great strolling streets provide connections between commercial, workplace, entertainment and residential neighborhoods and encourage shared use for cars, pedestrians and bicycles.

Site Development

The COR Master Plan illustrates a strong framework of green space, including a mix of public parks, destination amenities, courtyards, commons and other features. As a key component of the overall plan, this integrated system of parks, trails and open space provides the framework around which all other land uses are organized. Placemaking and connectivity are important site development considerations, linking each block and each sub-district with major public spaces nearby and with many other amenities and attractions in The COR.

Architecture

There are numerous opportunities to include buildings and other structures as significant design features within the proposed parks, trails and open space system for The COR. These could range from simple picnic shelters and landscaped arbors to more complex park buildings that might contain meeting rooms, rest rooms, storage areas and other facilities. Design of these important buildings should respond to the specific setting and landscape features in each park, and complement the overall character and quality of buildings located within surrounding blocks. Additionally, limited retail is planned along the perimeter of the park.

Table 7

COR5 Development Standards						
	Arterial Street	Destination Street	Parkway	Connector Street	Downtown Street	Local Street
Minimum lot size	0.5	N/A	0.5	0.5	0.5	0.5
Minimum lot width	N/A	N/A	N/A	N/A	N/A	N/A
Minimum lot depth	N/A	N/A	N/A	N/A	N/A	N/A
Allowable residential density in dwelling units per acre ⁽¹⁾	N/A	N/A	N/A	N/A	N/A	N/A
Minimum floor area ratio (FAR) for nonresidential uses/vertically mixed buildings/sites	N/A	N/A	N/A	N/A	N/A	N/A
Build to Line						
Front yard ⁽⁴⁾	30 feet as measured from building front to right-of-way ⁽²⁾⁽³⁾ (60% of front facade w/in max.)	N/A	10 feet as measured from building front to right-of-way ⁽²⁾ (60% of front facade w/in max.)	10 feet as measured from building front to right-of-way ⁽²⁾ (60% of front facade w/in max.)	10 feet as measured from building front to right-of-way ⁽²⁾ (60% of front facade w/in max.)	10 feet as measured from building front to right-of-way ⁽²⁾ (60% of front facade w/in max.)
Side yard	no req.	N/A	no req.	no req.	no req.	no req.
Rear yard	no req.	N/A	no req.	no req.	no req.	no req.
Driveway length (minimum)	25 feet	N/A	25 feet	25 feet	25 feet	25 feet
Building height (min. - max.)	1-2 stories.	N/A	1-2 stories.	1-2 stories.	1-2 stories.	1-2 stories.
Planter Style	N/A	N/A	Boulevard Sod	Boulevard Sod	N/A	Boulevard Sod
Tree Spacing (on center)	N/A	N/A	35 feet	35 feet	35 feet	35 feet
Boulevard Width	N/A	N/A	6 feet	6 feet	N/A	6 feet
Sidewalk Width	10 feet	N/A	6 feet	10 feet	10 feet	10 feet

1. Residential density is based on the net area of the parcel in question for parcels. In the event that public open space that is not dedicated to the City is developed independently of any particular residential project, the land area of the open space shall be divided equally among those abutting projects for purposes of density calculations.
2. Build to line shall be measured from building front to edge of right-of-way, or edge of sidewalk easement as defined by the City and said sidewalk must be encumbered by a sidewalk easement recorded with the office of the Anoka County Recorder.
3. The City may approve up to a 60-foot setback if it finds that topography or other factors require that a building be set back further to achieve acceptable grades or buffer between the street, the site entrance and the building.
4. In order to address vision clearance standards on higher speed roadways, parcels that are located at an intersection with an arterial roadway are allowed a build-to line of 35 feet from both streets.

A. Where commercial buildings are planned, at least sixty (60%) percent of street frontage of any lot shall be occupied by building facades meeting this build-to-line. On lots with more than one (1) street frontage, the build to line shall apply on each side fronting a street. An enclosed open area plaza space or outdoor seating with a decorative wall with a minimum height of three feet (3') and a maximum of four and one-half feet (4 ½') can be used to meet the sixty (60%) percent street frontage requirement.

B. Screening Of Parking Areas: Wherever a surface parking area faces a street frontage, such frontage shall be screened with a decorative wall, railing, hedge, or a combination of these elements, to a minimum height of three feet (3') and a maximum height of four and one-half feet (4 ½') above the level of the parking lot, at the build-to line. This screening may be broken into sections along the street edge provided it meets the sixty (60%) percent required.

Implementation

Introduction

This framework provides distinct strategies for guiding The COR's form and appearance. This framework's vision for the COR will take several years to implement. Successful implementation will require consistent application of the Design Framework by City staff. Zoning enforcement and design framework standards will not succeed without the cooperation and commitment of landowners, development interests, and the rest of the community.

Design Review

The Design Framework will be administered by staff as part of the development review process. Staff will incorporate design review to ensure compliance with the Design Framework as a standard step in the development review process.

This page intentionally left blank

APPENDIX A: SPECIFICATIONS AND DETAILS

Contents

Design Framework – The COR.....	1
Purpose	1
Application	1
Implied Responsibility	1
Part One: Overall Framework	2
Overall Framework - Context.....	3
Overview	3
Guideline Recommendations.....	3
Objectives.....	3
Overall Framework – Street Hierarchy	5
Overview	5
Guideline Recommendations.....	5
Objectives.....	5
Transit Overview	8
Transit Guideline Recommendations.....	8
Transit Objectives	9
Overall Framework - Streetscape	10
Overview	10
Guideline Recommendations.....	12
Objectives.....	12
Street Trees and Plantings	12
Street Furniture.....	14
Sidewalks and Boulevard	14
Street Lights	15
Standards for Outdoor Dining.....	15
Overall Framework - Parking	16
Overview	16
Guideline Recommendations.....	16
Objectives.....	17

Minimum Standards.....	20
Private Streets.....	24
Loading Areas.....	24
Overall Framework – Building Design.....	25
Overview	<u>2625</u>
Guideline Recommendations.....	<u>2625</u>
Objectives.....	<u>2625</u>
Architectural Overview	<u>2726</u>
Architecture Recommendations	<u>2726</u>
Overall Framework - Signage	<u>3029</u>
Overview	<u>3029</u>
Guideline Recommendations.....	<u>3029</u>
Objectives.....	<u>3029</u>
Definitions.....	<u>3029</u>
Standards	<u>3332</u>
Overall Framework – Stormwater Management.....	<u>4542</u>
Overview	<u>4642</u>
Objectives.....	<u>4642</u>
Guideline Recommendations.....	<u>4642</u>
Overall Framework – Parks/Public Spaces.....	<u>4844</u>
Overview	<u>4844</u>
Guideline Recommendations.....	<u>4844</u>
Objectives.....	<u>4844</u>
Part Two: Sub-district Framework	<u>5045</u>
Overview	<u>5045</u>
Public Realm/Streetscape	<u>5045</u>
Plazas.....	<u>5045</u>
Architecture	<u>5146</u>
Minimum Standards.....	<u>5146</u>
Sub-District Framework - COR1 Mixed Use Core.....	<u>5651</u>
Public Realm / Streetscape	<u>5751</u>
Site Development.....	<u>5751</u>

Architecture	5751
Sub-District Framework - COR2 Commercial	5953
Public Realm / Streetscape	5953
Site Development.....	5953
Architecture	5953
Sub-District Framework - COR3 Workplace	6256
Public Realm/Streetscape	6256
Site Development.....	6256
Architecture	6256
Sub-District Framework - COR4 Neighborhood	6458
Public Realm/Streetscape	6458
Site Development.....	6458
Architecture	6458
Sub-District Framework - COR5 Parks & Open Space	6660
Public Realm/Streetscape	6660
Site Development.....	6660
Architecture	6660
Implementation	6862
Introduction	6962
Design Review	6962

List of Figures

Figure 1: Development Master Plan 5.03	4
Figure 2: Street Hierarchy Map.....	7
Figure 3: Master Lighting Plan	11
Figure 4: Streetscape Master Plan	18
Figure 5: Parking District Map.....	19
Figure 6: Signage Plan	31
Figure 7: Sub-district Map.....	50

Appendix A: Specifications and Details

Design Framework – The COR

Purpose

The primary purpose of Design Framework is to set basic parameters, describe preferences and illustrate design intent. These framework standards serve as a framework within which creative design can and should occur – there is no one solution, but many options that meet the basic requirements of this document.

Application

The format and content of this framework are specifically tailored for use as a supplement to the Zoning Ordinance. This document is organized into two sections. The first section outlines issues and recommendations that apply to the entire COR. The second section highlights specific framework that apply to each sub-district within The COR. The City of Ramsey has adopted Development Plan 5.03 as the Master Plan for The COR. This master plan provides illustrative guidance for building locations and orientation. Any changes to this approved master plan must be reviewed and approved by the City Council as part of the development application. This Development Plan will be updated by the City as changes are approved.

Implied Responsibility

All participants in the development of The COR recognize the local and regional impacts of this project and the various systems that play an important role. Each parcel and each building must fit within the context of the entire plan. Individual projects must complement, not compete with, adjacent development in terms of public green space, walk and trail connections, stormwater management solutions, street layout, parking strategies, land use mix and building design.

Part One: Overall Framework

There are a number of framework standards that apply to the entire COR, including recommendations for stormwater management, parks, streets, land use, parking, transit and other development components. Many of these overall COR framework standards overlap, or are integrated with one another. For ease of discussion they are categorized according to the same list of 'layers' that formed the basic structure for the Master Framework:

- Context – local, city, regional
- Street Hierarchy--access, circulation, arrangement
- Streetscape—preferred design, location
- Parking -- quantity, location, type
- Building Design-- preferred uses, horizontal/vertical mixed use, built form, character of development
- Signage—design, location, quantity, type
- Stormwater Management-- surface water features, stormwater management
- Parks/Public Spaces – parks, trails and open space

It is essential that proposed design solutions for development projects and other improvements within The COR demonstrate an understanding of the interplay between these layers.

Overall Framework - Context

Overview

The COR is a unique area within the City; but it is a part of, and connected with, a variety of local, city-wide and regional systems (~~See Figure 1: Development Master Plan 5.03~~). Each development project, whether a single building, one lot, or a series of blocks, must provide reasonable links to these systems as a primary design objective.

Guideline Recommendations

To ensure that The COR takes full advantage of local and regional systems, development should:

- Provide safe, easily recognized connections to city, county and state trail corridors
- Make provisions for city and regional transit service and amenities (including the Northstar Line) and encourage their use
- Tie into, and improve, the Ramsey utility network
- Integrate with and complement the existing (and future) street framework
- Become an integral part of the city and county drainage/stormwater management plan

Objectives

- Overall COR design (and all new private development within The COR) will accommodate stormwater from new projects and from off-site, and highlight stormwater features as an amenity
- Bikeways and pedestrian routes into The COR from adjacent neighborhoods must be designed for safety and ease of access, suggesting that a person on a bicycle has an equally accessible route to downtown.
- Parks and open space will be easily accessible to all COR residents, visitors, people who work here and also for the citizens of Ramsey and the surrounding area. This connected green system is reminiscent of the world renowned 'Grand Rounds' of Minneapolis.

- DEVELOPMENT STATUS**
- EXISTING DEVELOPMENT
 - PROPOSED DEVELOPMENT
 - ACTIVE DEALS
 - UNDER CONTRACT
 - COMPLETED

- ACCESS**
- EXISTING SIGNALIZED INTERSECTION
 - FUTURE SIGNALIZED INTERSECTION
 - FULL INTERSECTION
 - NO LEFT OUTBOUND MOVEMENTS
 - PARKING GARAGE

- TRAFFIC INFORMATION**
- ADT INFORMATION TAKEN FROM 2009 ACTUAL COUNTS AND 2030 PROJECTED VOLUMES



Overall Framework – Street Hierarchy

Overview

The Development Master Plan defines a specific strategy for the layout of streets and blocks within, and around The COR. The size, type and configuration of this street hierarchy (See [Figure 1: Street Hierarchy](#)[Figure 2: Street Hierarchy](#)) is based on a combination of projected traffic volume, level of service at intersections, proposed adjacent land use (destination commercial, residential, civic, recreation, etc.) and desired aesthetic character.

Great streets are essential components of an attractive and inviting public realm. These guidelines promote a street system that balances pedestrian and vehicular use. Providing streets that support traffic flow is important, but also creating ample space for street-side activities, strolling promenades, pockets of green and other amenities is critical to the success of The COR. Streets will promote convenient access by car – to storefronts, to parking lots and ramps, to entertainment attractions – but will also encourage foot traffic as a primary way to move about and conduct business in the core area.

Guideline Recommendations

The proposed street and block pattern reflects a compact urban character, not allowing dead end streets or cul-de-sacs, in favor of a traditional grid pattern and connected streets including the following:

- Provide a street network that distributes pedestrian and vehicular traffic throughout the various districts in The COR and encourages a more dispersed and less congested traffic flow (many choices or travel paths).
- Provide a clear hierarchy of streets resulting in a simple and understandable system for movement – easy access and convenient circulation throughout The COR.
- Work with Anoka County to convert primary perimeter streets (arterials such as Ramsey, Armstrong and Bunker Lake Boulevards) to urban street sections, providing sidewalks and street trees to replace roadside ditches.
- Promote improvements that invite pedestrian and bicycle use including wide sidewalks, streetscape amenities and designated bicycle trails (both on and off-street).



Objectives

Creative design solutions for public realm improvements should reflect these basic street classifications (street hierarchy) including:

- Arterial street – these streets provide the boundary of The COR and all access into The COR will be from one of these three streets:
 - Bunker Lake Boulevard
 - Armstrong Boulevard
 - Ramsey Boulevard
- Destination street – signature addresses for shopping, entertainment, services, work place and other primary amenities
 - Sunwood Drive



- Parkway – premier ‘green streets’ adjacent to primary public park / green space, with more landscaping than other streets in The COR
 - Ramsey Parkway
 - Center Street (north of the roundabout)
- Connector street – primary routes that link various districts within The COR, usually providing the most direct means of getting from point A to point B
 - Rhinestone Street
 - Zeolite Street
 - Veterans Drive
- Downtown street – the most urban of street sections where high pedestrian traffic is intended and traffic calming measures such as on street parking, bump outs and other methods will be employed
 - Center Street (south of the roundabout)
 - Sapphire Street (north of Sunwood)
 - Other streets as shown on the Street Hierarchy Map
- Local street – neither destination nor primary connector routes, these streets provide much of the rest of the street grid throughout The COR.



These street hierarchy classifications are intended to provide guidance regarding the streetscape, but it should be noted that within a street classification, there may be construction or design distinctions, based on the sub-district classification. For example, Sunwood Drive is defined as a destination street throughout The COR, but the design may be different between the COR1 and COR2 sub-districts. The Master Streetscape Map will provide design direction.

Transit Overview

The COR is designed to be a Transit Oriented Development (TOD) in a variety of ways that go beyond providing a walkable public realm and connected street grid. The Master Plan also includes a multimodal transit station, with dedicated commuter parking, integrated with other uses at the heart of the retail, restaurant and entertainment district. This station functions as a hub where local circulator transit comes together with regional transit service and the Northstar Corridor. The COR is the Twin Cities' first and only transit-oriented development along the new Northstar Commuter Rail Line. Ramsey Station at The COR will open for riders boarding the train in November 2012. As Northstar's most visible station, The COR will immediately bolster the ridership on the line and continue to build recognition for this regional service.



Transit components include the following:

- Ramsey Star Express service provides peak period, peak direction bus service between downtown Minneapolis and Ramsey until the Northstar Commuter Rail station stop is complete
- Northstar Commuter Rail provides train service between Big Lake and downtown Minneapolis
- 350 park and ride parking spaces are provided for commuters adjacent to the transit station
- Pedestrian and bicycle connections are emphasized in the Master Plan as major links between the transit station, various districts within The COR and into the surrounding neighborhoods
- The COR can accommodate Metro Mobility, citywide circulator bus or town trolley connections as part of local and regional service to the transit station



The COR also encourages developers to participate in a Travel Demand Management (TDM) program to both assist and encourage residents and visitors to take advantage of the various modes available for their commuting and travel needs. The TDM program draws from incentives and services available through Anoka County and Metro Commuter Services that match riders with carpools and vanpools, provide discounted transit passes and manage work hours among other functions.

- Developers shall submit a TDM plan with their site plan application for new development and work with the City to implement their plans.

Transit Guideline Recommendations

Transit is an important component of the overall plan, with expectations for more ridership, using a greater range of transit options as they become available. More people, together with the mix of activities and amenities in The COR, encourages better designed, better connected transit service. It is a shared responsibility between city, county and developer to promote transit use, with both policy and bricks-and-mortar attention to the following framework:

- Understand and take advantage of opportunities to use existing and proposed transit components

- Provide transit related facilities specifically linked to uses and character within each COR district, including signage and lighting for way-finding and bicycle amenities
- Building future Northstar Commuter Rail riders through the Ramsey Star Express bus service

Transit Objectives

The primary objective is to provide a balance of transit service, bicycle and pedestrian connections and lanes to move traffic. The framework for The COR promotes public transportation as part of the solution and suggests a variety of street improvements and other amenities to invite increased use. Photographs throughout the framework suggest some of the many possibilities.

Overall Framework - Streetscape

Overview

The Master Plan defines a specific strategy for the layout of streets and blocks within and around The COR. The amenities within the public right-of-way -and immediately adjacent -play an important role in the aesthetics of The COR. Great streets are essential components of an attractive and inviting public realm. Developing a streetscape that is comfortable and inviting to pedestrians is important to realizing the vision for The COR. The framework will encourage interesting and inviting places for the public.

The Streetscape framework defines the visual character and physical improvements for all public spaces within The COR. The document also provides the general framework and examples for design of proposed quasi-public and private space located within each development parcel.

Public realm/streetscape framework focus on the following elements:

- Parks, plazas and other public gathering spaces
- Street/sidewalk character and streetscape elements
- Bicycle/pedestrian connections (on-street and off-street)
- Residential courts, pocket parks and other private green space



The goal is to foster a safe and interesting public realm that will invite pedestrian activity, promote traffic calming, increase transit use and encourage community gathering. Street trees, lighting and decorative fencing provide the backbone for streetscape improvements. Added detail, such as special pavements, street furniture, public art and layered plantings will highlight specific nodes or uses. The City has developed a series of street cross-sections to illustrate these design expectations. Typical street sections are provided in Appendix A as a reference.

Destination and Connector streets must balance a high level of service for the automobile with attractive and inviting amenities for the pedestrian including:

- Provide gracious sidewalk width to support intensity of pedestrian traffic in the core
- Install street trees to frame the street and provide shade
- Provide street lighting that meets all safety standards and design criteria, while creating a signature character for this district
- Explore a range of options for streetscape improvements including special pavements, interesting concrete tinting or scoring patterns, additional plantings, ornamental fencing and other features (note, however, that simpler is better and too much clutter is a negative)



The COR includes a network of bicycle/pedestrian trails and walkways (both on and off-street) that connect adjacent sub-districts to the Mixed Use Core. As you approach the core, these connections tend to become part of the shared right of way along the major streets, or become part of the urban park spaces. Bicycle riders may choose to share the street with vehicular traffic, or dismount and walk their bicycles along with the other pedestrians using the sidewalks. Providing and maintaining these bicycle and pedestrian connections should be a key component for all development projects in the core.



Figure 23: Master Lighting Plan

Guideline Recommendations

The proposed street and block pattern reflects a compact urban character, including the following:

- Bike racks interspersed throughout The COR to encourage cycling as an alternative mode of transportation.
- Benches on the public sidewalks to encourage people to linger in The COR
- Trees and planters along the streets to create an inviting space
- Wide sidewalks and both on- and off-street bicycle trails
- Kiosks and other way finding tools for visitors and residents in The COR
- Outdoor dining is encouraged on the street side of buildings within all districts.
- Public plaza space is strongly encouraged to be located adjacent to the streets



Objectives

Creative design solutions for streetscape improvements should include:

- Streetscape improvements that provide traffic calming, particularly along Destination and Downtown streets
- Inviting streets that draw you into and through The COR
- A marriage of building design and streetscape design that encourages active spaces near the streets



Street Trees and Plantings

Street trees and planter boxes are a critical element in the unique character of The COR and will be used to help distinguish between different street types and sub-districts within The COR. However, there may be variety within the same street when the street crosses into sub-districts.

- Street trees will be chosen to ensure that the species allow for clear pedestrian access along the streets and require minimal maintenance.
- Along Destination, Downtown, Parkway and Local streets, where regularly spaced blocks exists, one (1) tree species shall be provided per block. In order to provide variety and protect against disease, adjacent blocks shall not be allowed the same street tree. Initial development along a block shall establish the tree species for that block, subject to City review and approval.
- Along streets without regular block space or longer blocks, such as Connector and Arterial streets, the City may approve groupings of 3-6 trees of one (1) species in lieu of the regular block spacing.
- Alternatives to the above mentioned planting plan shall be subject to review and approval by the City Council.

Destination Street Trees:

- Autumn Blaze Maple (*Acer x freemanii* 'Jeffersed')
- Bicolor Oak (*Quercus bicolor*)
- Sienna Glenn Maple (*Acer x freemanii* 'Sienna')
- Skyline Honeylocust (*Gleditsia triacanthos var. inermis* 'Skyline')
- Ginko (*Ginkgo biloba*)
- Accolade Elm (*Ulmus x 'Accolade'*)

Parkway Street Trees:

- Valley Forge Elm (*Ulmus americana* 'Valley Forge')
- Bitternut Hickory (*Carya cordiformis*)
- Siouland Poplar (*Populus deltoides* 'Siouland')
- Sienna Glen Maple (*Acer x freemanii* 'Sienna')
- Boulevard Linden (*Tilia americana* 'Boulevard')
- Northern Catalpa (*Catalpa speciosa*)
- Spring Snow Crabapple (*Malus* 'Spring Snow')
- Kelsey Crabapple (*Malus* 'Kelsey')
- Korean Mountain Ash (*Sorbus alnifolia*)
- Ohio Buckeye (*Aesculus glabra*)
- Ginkgo (*Ginkgo biloba*)

Connector Street Trees:

- Bicolor Oak (*Quercus bicolor*)
- Northern Red Oak (*Quercus rubra*)
- Princeton Elm (*Ulmus americana* 'Princeton')
- Accolade Elm (*Ulmus x 'Accolade'*)
- Autumn Blaze Maple (*Acer x freemanii* 'Jeffersed')
- Skyline Honeylocust (*Gleditsia triacanthos var. inermis* 'Skyline')
- Kentucky Coffeytree (male) (*Gymnocladus dioicus*)
- River Birch (single stem) (*Betula nigra*)
- Black Alder (*Alnus glutinosa*)
- Black Cherry (*Prunus serotina*)
- Spring Snow Crabapple (*Malus* 'Spring Snow')
- Kelsey Crabapple (*Malus* 'Kelsey')
- Japanese Tree Lilac (*Syringa reticulate*)
- Thornless Cockspur Hawthorne (*Crataegus crus-galli var. inermis*)

Downtown Street Trees:

- Princeton Elm (*Ulmus americana* 'Princeton')
- Accolade Elm (*Ulmus x 'Accolade'*)
- Autumn Blaze Maple (*Acer x freemanii* 'Jeffersed')
- Skyline Honeylocust (*Gleditsia triacanthos var. inermis* 'Skyline')
- Kentucky Coffeytree (male) (*Gymnocladus dioicus*)
- River Birch (single stem) (*Betula nigra*)
- Black Alder (*Alnus glutinosa*)
- Black Cherry (*Prunus serotina*)
- Spring Snow Crabapple (*Malus* 'Spring Snow')
- Kelsey Crabapple (*Malus* 'Kelsey')
- Japanese Tree Lilac (*Syringa reticulate*)
- Thornless Cockspur Hawthorne (*Crataegus crus-galli var. inermis*)

Local and Arterial Street Trees:

Local and Arterial Street trees may be chosen from any species on the above lists.

Planter Beds/Boxes/Tree Grates

- Planter beds, tree grates and planters shall be as shown on the Streetscape Master Plan. Details and specification shall be added to Appendix A as developed and approved by the City. Appendix A shall be amended as needed.
- Irrigation shall be provided to ensure survival of plant materials. The City shall provide irrigation systems along the Parkway and Destination streets. Unless otherwise approved, all other irrigation shall be the responsibility of the landowner.

Street Furniture

Bike racks, trash enclosures and benches are encouraged on all streets, but will be required on Destination, Connector and Parkways and other streets as shown conceptually on the Streetscape Master Plan.

Bike racks shall be the standard bike rack (see Appendix A for specifications).

Trash enclosures shall be the standard trash enclosures (see Appendix A for specifications).

Benches shall be the standard bench (See Appendix A for specifications).

Benches shall be grouped in twos that face each other and provide an opportunity for an outdoor conversation space.

Alternative bike rack, trash enclosures and bench designs will be considered on a case-by-case basis. The City will review alternative designs as part of the site plan review and will evaluate these alternatives based on the following:

- Does the design maintain the character of the district?
- Does the alternative design maintain the quality of the standard feature?
- Does the design provide a relationship between the public elements of the streetscape and the building that would not otherwise be possible?

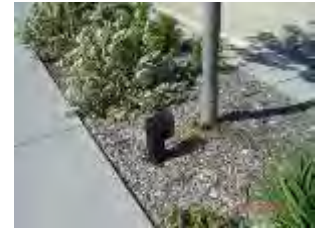

Sidewalks and Boulevard

In the design framework, the term “boulevard” is defined as “the space between the sidewalk and the curb.” The boulevard area provides the required space for public features such as street lights, benches, fire hydrants, street signs, etc. The boulevard will have different characteristics based on the street hierarchy.

The street width and layout within different zones may affect the ability of a particular development to provide the minimum boulevard width and the minimum sidewalk width within the existing public right-of-way. In those cases, the landowner shall provide a permanent public easement over the portion of the sidewalk that is located on private property.

Street Lights

Street lights are owned and installed by Connexus Energy. The streetlight design was developed in conjunction with the City of Ramsey and Connexus (See [Figure 2: Master Lighting Plan](#)~~Figure 3: Master Lighting Plan~~). The standard street lights are designed to accommodate banner arms should banner signage be desired. The banner arms should be the manufacturer's standard break-away banner arms to ensure safety and minimize maintenance costs. Connexus provides street light maintenance for the City. Connexus bills the City of Ramsey for the cost of installation and maintenance.

The choice of street light was intended to emphasize the pedestrian scale of The COR. Light poles within the public right-of-way should be planned to accommodate banners, flowers, hanging artwork and electrical outlets.

There are three (3) different streetlight types within The COR:

- 24-foot high poles at intersections
- 14-foot high poles at mid-block
- 12-foot high poles at The Draw



The City will ensure that the appropriate streetlights are installed on all public streets as described by the Design Framework. Private developers shall provide parking lot or other project lighting that retains these design

objectives. All lighting shall comply with City Code performance standards for lighting. All lighting shall be reviewed by City staff to ensure compliance with the Design Framework and City Code standards described above.

Standards for Outdoor Dining.

Outdoor dining is encouraged as an attractive addition to a pedestrian- and retail-friendly, vital COR. Such dining is encouraged subject to the standards in Section 117-118 of the Zoning Ordinance.

Overall Framework - Parking

Overview

Balancing the realities of car-related necessities (streets, parking and so on) with future transit service and the desired character of The COR is a significant challenge. The goal is to provide adequate parking; both quantity and location, while promoting new strategies that support the overall needs of The COR. Parking will be provided through a combination of on street spaces, off-street surface lots, underground lots and structured ramps to support the mix of uses at the core.

Parking structures should contribute to the overall character and image of The COR. Ramp design should include elements, colors and materials that reflect, or complement surrounding buildings. Liner stores or other street level uses should be integrated into ramp design along important street frontages. The City also encourages developers to wrap the ramp with multi-story uses that will provide commercial and residential opportunities and help to define the street edge.

Guideline Recommendations

Parking guidelines encourage the following:

- Locate surface parking lots away from the major streets, either behind or to the side of primary buildings; surface parking lots along major street frontage are not allowed in the core area
- Minimize surface parking lots in favor of other solutions including underground parking to serve residential buildings, on-street parking to serve retail shops and parking ramps
- Provide a combination of fencing, landscaping and landform to screen parking areas from major streets and important views, soften parking area edges, provide shade, integrate native plantings, offset islands and reduce to 'sea of parking' image
- Create strategies for shared parking between adjacent uses, taking advantage of peak and off-peak cycles, business hours, nighttime activities, special events and other needs
- Provide alternative surfaces for secondary (less frequently used) parking areas including porous pavements, green pavements and so on
- Provide facilities or services that respond to and connect with future transit to reduce required parking, including shuttle/circulator bus, bicycle lockers
- Provide flexibility including hours for on-street parking, security and enforcement practices, permit or metering
- Provide parallel parking on both public and private streets throughout The COR, to add parking and create a traffic calming, pedestrian buffer; Bumpouts are encouraged as a traffic calming measure on all streets within the COR.
- Explore options to integrate stormwater management requirements into parking area design
- Provide parking spaces for typical daily use, satisfying both quantity and location needs through a mix of on street, small surface lot, underground and ramped parking solutions
- Provide options for additional/overflow parking to support holiday traffic and special events including porous pavements, turf parking areas (Netlon and other soil amendments) or shuttle service from nearby parking areas
- Encourage shared parking solutions that target around the clock shifts in destination, audience or take advantage of peak/off-peak hours of operation for various uses within the core area

- Promote municipal parking ramps as the primary facility to meet public parking needs within the core area
- Discourage driveway access to parking facilities along Arterial, Destination and Parkway streets, in favor of side streets.

Objectives

The primary objective is to provide a balance of surface lots, on-street and structured parking, with ample quantities and close proximity to serve the mix of uses in The COR. The Design Framework anticipates the construction of a total of 3 parking structures in COR1 to serve the needs of the area by providing structured parking that can be shared among users, allow developers to maximize the development on each individual lot.

As discussed later in this section, sizing and timing of the structured parking will be finalized as the area develops and parking demand grows. In addition to providing adequate space, excellent design is a major factor as well. The framework for The COR encourages creativity, innovation, quality and attention to detail in every aspect of project development, including parking solutions. Photographs throughout the Design Framework suggest some of the many possibilities.





Figure 34: Streetscape Master Plan

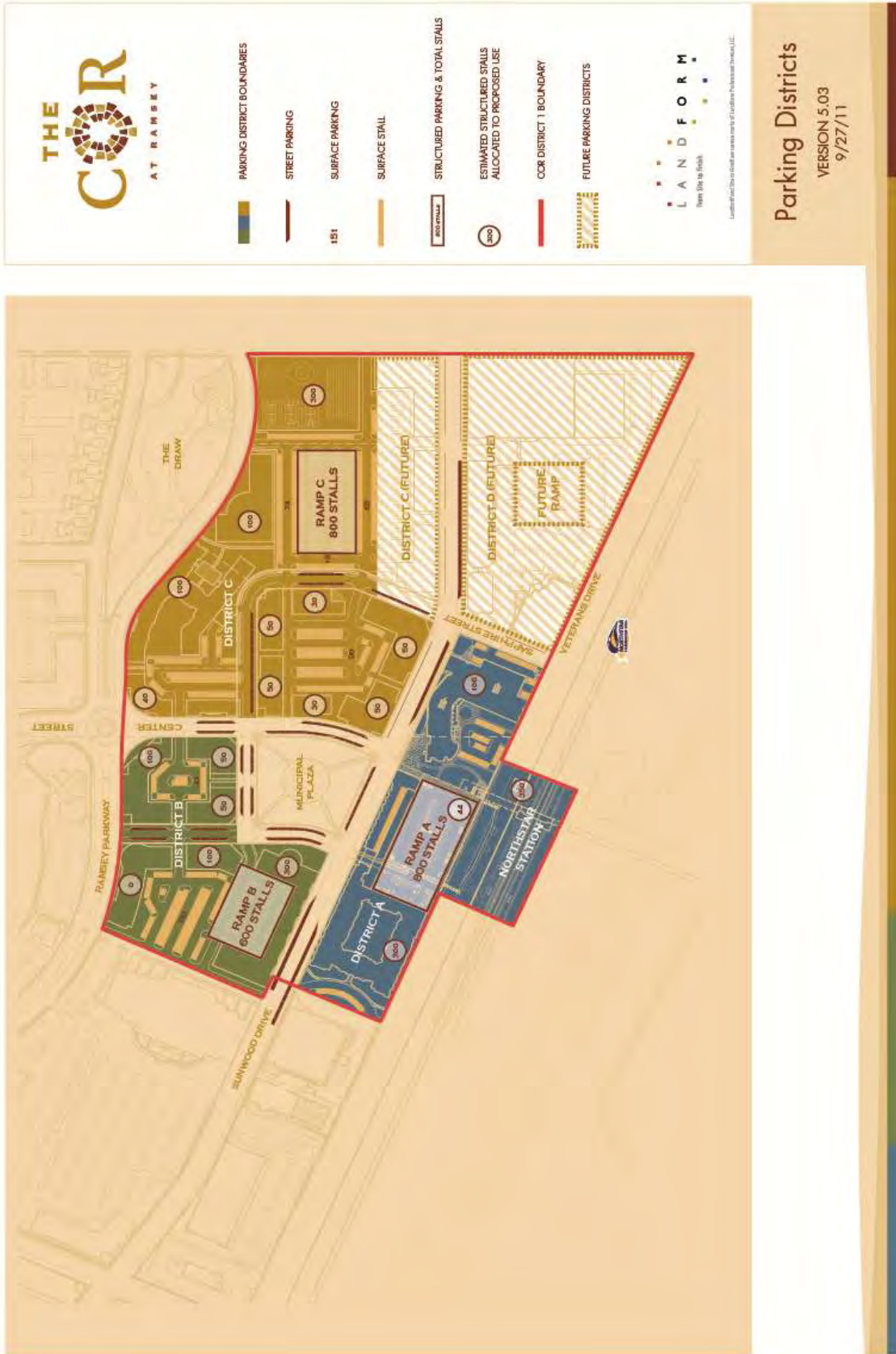
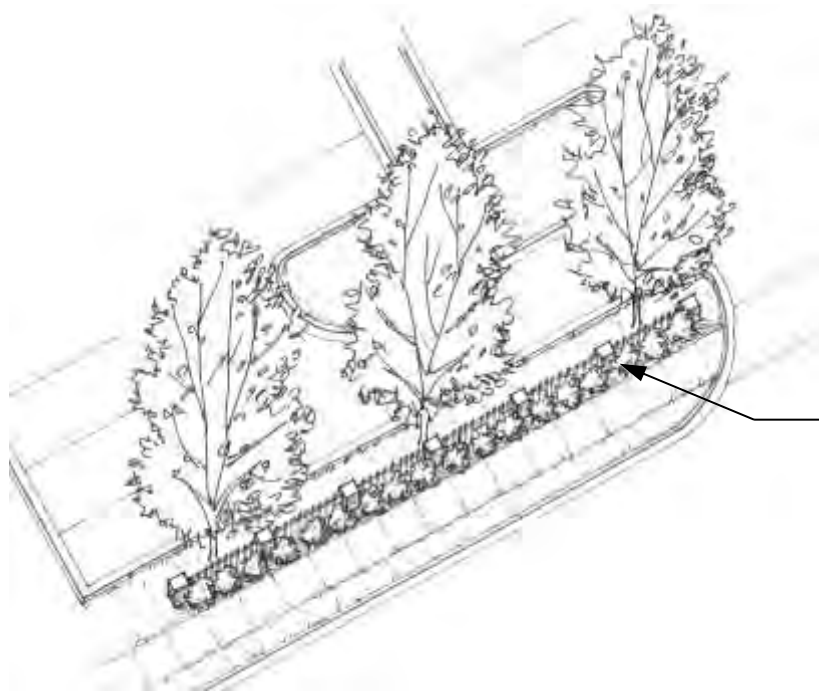

Figure 45: Parking District Map

Minimum Standards

Parking in The COR is intended to be shared to the greatest extent practicable in all mixed-use areas. The parking standards are intended to provide a practical basis for providing adequate parking within the COR District through a careful analysis of uses, shared parking arrangements, use of public street parking and reduction allowances for the proximity to the transit station. A parking plan has been prepared to identify the planned number, location, sharing arrangements and public use (see [Figure 3: Streetscape Master Plan](#), ~~Figure 4: Streetscape Master Plan~~ and ~~Figure 4: Parking District Map~~ [Figure 5: Parking District Map](#)). The parking plan provides information that can be used to help address longer term parking arrangements where the possibility of use conversion or building expansion exists. Parking shall be provided under any of the following arrangements:

- A. No parking shall be located between the front of the principal structure and the street on parcels abutting Destination and Downtown streets in COR1.
- B. Not more than fifty (50%) percent of the parking shall be located in front of the principal structure and the street on parcels abutting Arterial, Parkway, Connector and Local streets.
 1. In the COR2 district, developments may be allowed more than fifty (50%) percent parking in the front yard, provided all other design standards have been met, including the use of a wall, railing, hedge or combination to create a street edge and screen parking.
- C. Wherever a surface parking area faces a street frontage, such frontage shall be screened with a decorative wall, railing, hedge, or a combination of these elements, to a minimum height of three feet (3') and a maximum height of four and one-half feet ($4\frac{1}{2}'$) above the level of the parking lot, at the build-to line required for the property. The amount of required screening may vary by sub-district and street frontage and is described in Part Two of this document.



Landscaped edge that combines fence with trees, low shrubs and ground cover for parking lot screening and buffering along sidewalk to screen parking

- D. No parking spaces shall be located on corner lots at the point of street intersections.
- E. Shared parking in COR1 will be accomplished through a Parking Use and Maintenance Agreement (PUMA).
- F. Off-street parking in the COR2 and COR3 sub-districts shall be secured for public use through parking easements and other appropriate conveyances. Shared parking arrangements between nearby uses are encouraged in both sub-districts.
 - 1. The City may approve joint parking for one or more businesses where the total number of parking stalls provided for joint use is less than the sum of the total required for each business should they provide them separately. The applicant must demonstrate the feasibility of the arrangement in a written report. Such a permit shall not be granted except when the following conditions are found to exist:
 - i. Proximity. The building or use for which application is being made to utilize the off-street parking facilities provided by another building or use shall be located within three hundred (300') feet of such parking facilities, excluding public rights-of-way.
 - ii. Conflict in Hours. The applicant shall demonstrate in documented fashion that there is no substantial conflict in the principal operating hours of the two (2) buildings or uses for which joint use of off-street parking facilities is proposed.
 - iii. Written Consent and Agreement. A legally binding instrument, executed by the parties concerned, for joint use of off-street parking facilities, duly approved as

to title of grantors or lessors, and in a form and manner of execution approved by the City Attorney, shall be filed with the City Clerk and recorded with the Anoka County Recorder or Registrar of Titles, and a certified copy of the recorded document shall be filed with the City within sixty (60) days after approval of the joint parking use by the City or the interim use permit shall be considered null and void.

- G. On-street parking adjacent to buildings shall not be used for the purposes of calculating parking requirements.
- H. Within the COR-4 sub-district, parking on individual parcels serving individual uses may be provided if designated and approved as part of the master plan.
- I. Within all sub-districts, a minimum driveway length of twenty-five (25') feet is required to limit conflicts between vehicles parked in the driveway and street or sidewalk users.
- J. In order to ensure the pedestrian orientation of the COR Districts, minimum/maximum on-site parking standards are set based on the following table:

Table 1

Use	Minimum number of parking stalls	Maximum number of parking stalls*
Retail	2 per 1,000 sq. ft.	4 per 1,000 sq. ft.
Restaurants	3 per 1,000 sq. ft. 1 per each 2 seats	5 per 1,000 sq. ft. 1 per each 1 seats.
Offices	2 per 1,000 sq. ft.	3 per 1,000 sq. ft.
Medical offices, clinics	2 per 1,000 sq. ft.	4 per 1,000 sq. ft.
Health clubs	3 per 1,000 sq. ft.	5 per 1,000 sq. ft.
Theaters, places of assembly	1 per 5 seats	1 per 3 seats
Residential		
Attached or detached	1 per unit	2 per unit
Multifamily units	1 per unit	2 per unit

*If a parking structure is provided on site, maximum parking stalls do not apply.

- K. Non-Specified Uses. For uses not specifically listed above, off-street parking requirements shall be computed by the Zoning Administrator on the same basis as required for the most similar listed uses. In such cases, the Zoning Administrator shall also consult off-street parking reference materials including, but not limited to, manuals prepared by the American Planning Association and Institute of Transportation Engineers.
- L. Handicap Parking. The size, number, and location of stalls reserved for handicapped parking shall be provided and identified as required by applicable regulations. These spaces are included in the computation for the minimum parking space requirement.
- M. Change in Land Use. When the site intensity or use of a building and/or property is increased with consequential effect upon the parking requirements as prescribed in this Section, the

parking requirements as prescribed herein shall be used to provide for such increase in the site intensity and/or use.

- N. Use of required parking spaces. Required parking spaces must be available for the use of residents, customers or employees of the use. Fees may be charged for the use of required parking spaces. Required parking spaces may not be assigned in any way to a use on another site, except for joint parking situations. Also, required parking spaces may not be used for the parking of equipment or storage of goods or inoperable vehicles.
- O. Transit Service Reduction. The minimum number of parking stalls required on site may be reduced by 10% for any parcel located within ¼ mile of a transit stop. To qualify for this reduction, the transit stop must provide regular service on all days of the week and direct pedestrian access must be provided between the building and the transit stop.
- P. Bike Racks. In addition to the bike racks provided as part of the streetscape, individual businesses are encouraged to provide bike racks for customers. Bike rack locations will be reviewed and approved by the City as part of the site plan review.
- Q. Increase to Maximum Required Parking. If additional parking is sought to exceed these maximum requirements, a conditional use permit can be sought to increase maximums up to twenty-five (25%) percent.
 - 1. In the COR-2 sub-district, an increase of twenty-five (25%) percent in the maximum number of parking stalls is permitted without the issuance of a conditional use permit if approved as part of the site plan.
- R. In the COR1 sub-district, a PUMA (Parking Use and Maintenance Agreement) shall be applied to all development as follows:
 - 1. It is the City's intent to maximize development on individual lots. In order to help landowners accomplish this goal, the City will develop public parking ramps, which will be available for public parking within The COR. In order to minimize the amount of the site required for parking, the landowner may choose to enter into the PUMA for utilization of the public parking ramps to meet all or a portion of their minimum parking requirements.
 - 2. Each development shall be subject to a PUMA that specifies that each property in the COR1 shall be financially responsible for its proportionate share of a shared parking facility. The proportionate share shall be determined on the basis of the property's off-street parking needs, as determined by the parking requirements of Item J above.

3. The City shall establish fees by ordinance. The developer shall be responsible for payment in an amount equal to the value of the required parking on a per-stall price basis for ramp parking through the PUMA. The City will determine the appropriate contribution.



4. Funds collected by the City shall be deposited in a special fund used only to acquire and/or develop off-street parking facilities for the COR. Financial responsibility shall cover the construction and continuing maintenance of the parking facility.
5. The parking facility may be constructed and maintained by the City or by a private management entity acceptable to the City.

Private Streets

Private streets may be allowed within residential subdivisions, subject to the standards in Section 117-112 (e)3.b. of the Zoning Ordinance.

Loading Areas

- A. Loading areas and docks shall be located in the rear of the building.
- B. Loading areas shall not be located in the front yard and shall be fully screened from public streets, public parks and residential areas through landscaping and building design measures.



B.

This page intentionally left blank.

Overall Framework – Building Design

Overview

The COR Development Plan 5.03 identifies the preferred mix and approximate location of a variety of land use types. Together with the Zoning Code, this Design Framework focuses on the following overall objectives:

- Promote vertical and horizontal mixed use (within a building, within a block, within a district)
- Provide a variety of housing types, styles, pricing
- Encourage increased density in and around the central core area
- Promote an interesting mix of building styles, scales and massing for each sub-district
- Support creative, innovative, high quality design solutions as the benchmark for success
- Integrate mix of uses with public green space within each district
- Provide a variety of commercial types
- Mix residential and commercial uses to promote street-level activity throughout the day

Guideline Recommendations

The mix of land uses in The COR will encourage activity during the day and into the evening and nighttime hours. As a focus of commerce, employment, recreation and housing, The COR resembles a small to medium size Midwestern downtown in scale and character. Land uses are intentionally mixed, to bring shoppers and workers into the area during the day and attract new residents and visitors to entertainment venues in the evening.

The civic component of The COR, anchored by City Hall, Police Station and variety of public spaces and squares, adds an important element to the land use mix and brings a level of authenticity to the district.

Objectives

- Encourage vertical mixed-use in the core with housing and office space over retail uses along the street, particularly in the center of the district.
- In residential districts, particularly closer to the core, a limited amount of retail uses will be encouraged to service residents and provide nearby places to gather.
- Promote innovative models for housing that include a mix of townhomes, flats and lofts within single buildings or on the same block.
- Accommodate larger, ‘big box’ retailing and auto-oriented uses within the COR2 sub-district only if innovative design approaches are used including two story buildings, use of liner stores facing the street, minimal blank walls, creative parking strategies, etc.
- Where similar uses create a ‘family’ or campus of buildings (e.g. medical campus), buildings should reinforce the street edge and parking should be set within the core of the block.
- Uses shall promote pedestrian friendly streets, contributing to street level activities and overall visual character of each district.
- All uses should reinforce the street edge.

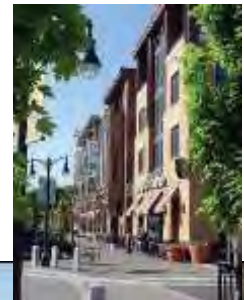

Architectural Overview

High quality architecture is an essential component in fulfilling the objectives of the Design Framework. Rather than prescribing a particular style, these architectural guidelines are intended to encourage an integration of both traditional and contemporary design. Architectural designs should provide a consistent quality, measured, to a great degree, by the pedestrian experience along the street and by an architectural expression that provides character without being thematic, obtrusive, or artificial. Architectural character should strive to be authentic and varied, but not 'thematic'.

Architecture Recommendations

Of all the layers that combine to form The COR Development Plan, architecture will typically be the most prominent development component. Both visually and physically, architecture will play a major role in defining the overall design character and mix of uses for The COR. It is crucial that the design and location of buildings address these architectural guidelines, with specific emphasis on the following:

- An animated street presence with a mix of street-level uses, interesting building façades, many doors and windows on the street, careful design of lighting, awnings, signage and other elements that animate the pedestrian experience

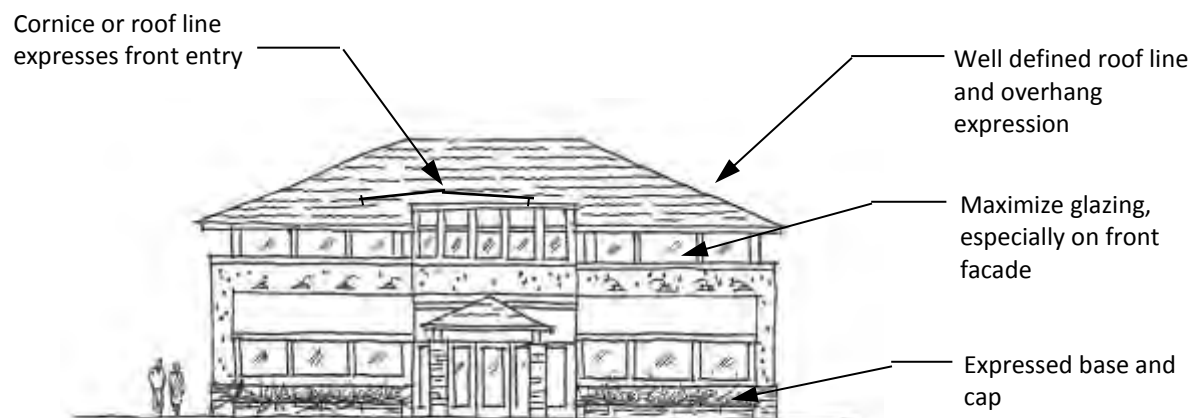

- Variety in building design, character and expression; not one theme or building style, but a thoughtful integration of many design solutions
- Variety of building types including a range of height, scale and proportion, that support an integrated mix of housing options, shopping destinations, entertainment venues, civic structures and other COR uses
- Use of high quality materials, suggesting a preference toward native materials and masonry elements, with respect for local building techniques
- Building location is as important as building style; special architectural elements, character, transparency and a higher level of materials and detailing should be used to highlight key streets and important crossroads throughout The COR
- Buildings should always be located at all four corners of intersections.
 - In the COR2 sub-district, if the City finds that there are unique circumstances where buildings cannot be located on the corner, the City may approve the use of fences, walls or other design elements to create that "street edge"

- Buildings will be located at the street right-of-way line (zero setback), but also allow recessed space for outdoor dining and other street level activities providing some minor deviation for variety
- Greater emphasis should be given to architectural elements, materials and other design features for buildings located at primary intersections, or where streets intersect with parks, such as the streets that front on or end near the Municipal Plaza. These locations can often be seen from several directions, perhaps terminate a view from a distance down the street or sit at a prominent node; They will likely become future landmarks or helpful orientation/wayfinding icons as The COR develops
- Encourage both vertical mixed use (within each building) and horizontal mixed use (within each block) throughout this district
- Include a mix of housing, civic, retail, restaurant, entertainment, performance and other uses that encourage a variety of activities throughout the day.
- Minimize openings between buildings, although limited driveway access and some provision for pedestrian connections through blocks are encouraged – gaps between buildings to accommodate surface parking lots, greater building setbacks or other purposes are discouraged
- Use recessed entries and windows to create street-level interest, variety and enhance pedestrian scale along street frontage

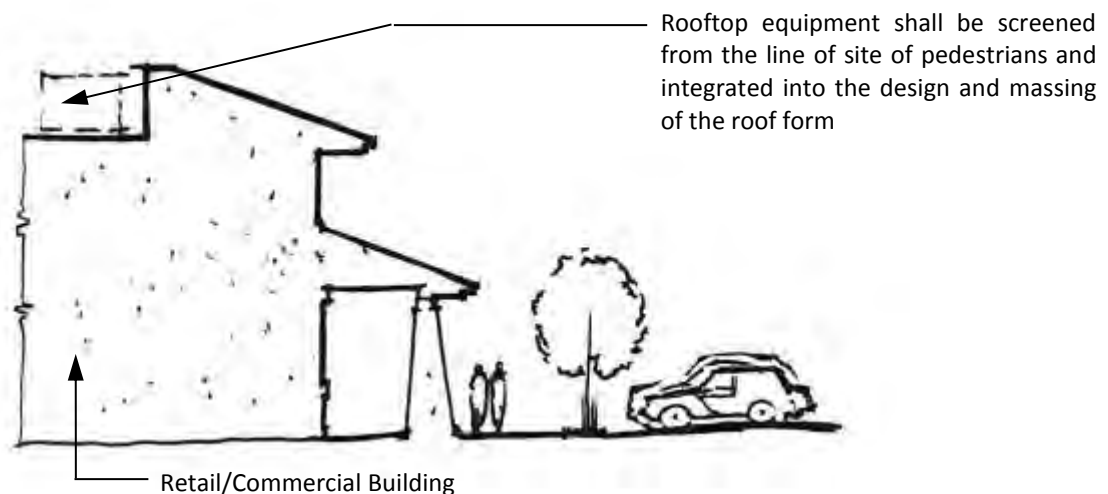
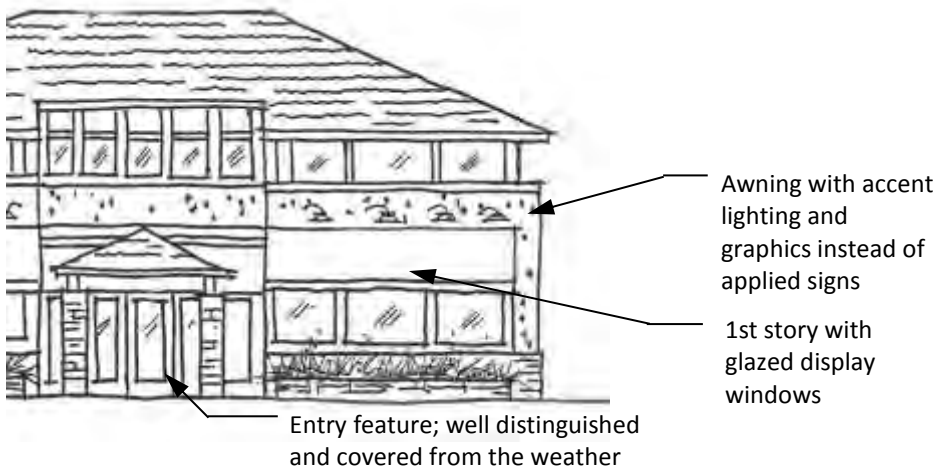

- Equipment, mechanical systems, transformers, etc. must be screened from view in a way that is integral to the architecture of the building. Screening should be accomplished with materials similar to or compatible with materials used on the main structure; metal fencing or mechanical vent screens alone are not sufficient.
- Roof lines and cornice details shall be completed in a 3-dimensional manner so that the back of roof features or similar unfinished areas are not visible.

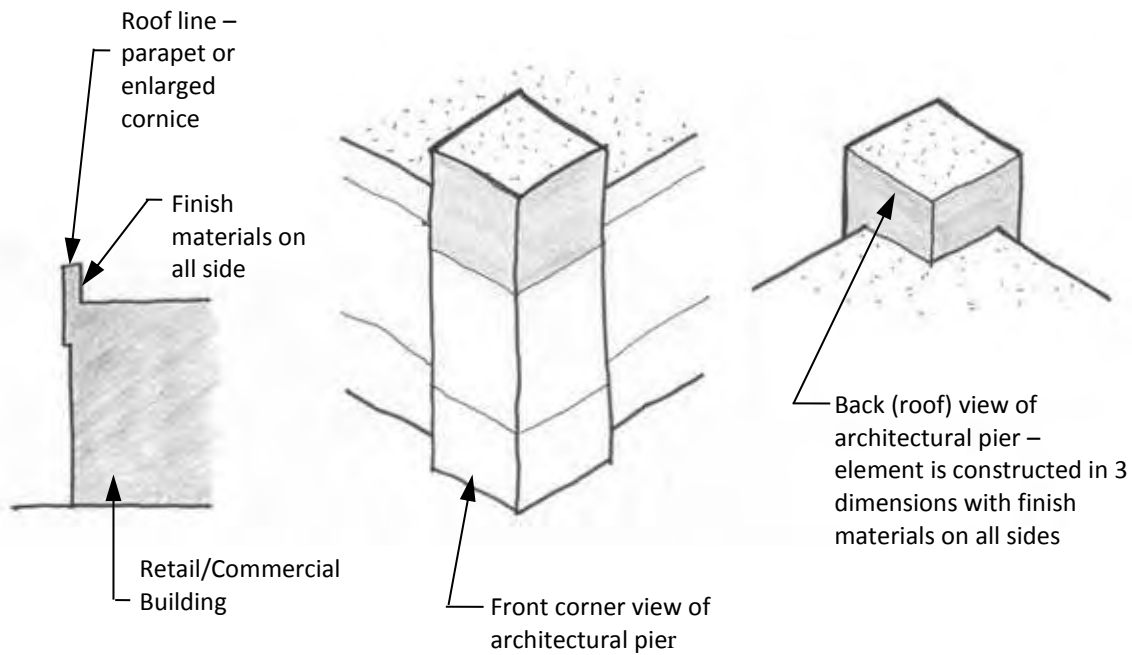

Overall Framework - Signage

Overview

Signage within The COR should provide a system for clear wayfinding for all modes of transportation and should ensure successful business operation while maintaining the design aesthetic of this unique project. These sign standards are intended to allow flexibility and creativity while maintaining the design concepts of The COR. Due to the distinctive nature of The COR, the sign standards from the City Code are not applicable and signage shall be allowed as prescribed by the Design Framework. A Master Sign Plan identifies the location of key sign locations (see [Figure 5: Signage Plan](#)~~Figure 6: Signage Plan~~).

Guideline Recommendations

The COR development manager shall prepare a Master Sign Plan for the public elements of the project, which are in compliance with the design framework and will be adopted by reference. The Master Sign Plan will specifically address public signs including:

- The three (3) off-site community signs
- Banner signs on light poles
- Signage for public parks
- Signage for public parking ramps
- Signage for public buildings
- Community kiosks



Objectives

Signage should be used as a tool to help identify businesses and neighborhoods with The COR and should have elements that are focused on the pedestrian nature of The COR as well as the signage needs for businesses.

- Signage and lighting which is integrated into the design of the building is encouraged.

Definitions

Awning Sign means a sign incorporated into or attached to an awning.

Community sign means an off-site sign identifying the development name and key tenants. Community signs may also include public information. Reader boards are allowed to be incorporated into community signs within The COR. [Gateway and kiosk signs are part of this category.](#)

Temporary Sign means a sign which is erected or displayed for a limited period of time and not affixed to a Minnesota State Building Code approved structure.

Project sign means a freestanding area identification sign which identifies a single-family or multifamily residential subdivision, a commercial development or an industrial park or office park and which is located on the same [parcel-site](#) as the development it identifies. [A site shall be identified as the block in which the use is located.](#)

Projecting sign means any sign, all or any part of which extends beyond the surface of the building or wall by more than 16 inches.

Public Realm/Streetscape sign means any sign erected and maintained by public officials or public agencies, or approved and authorized for use by state or local governmental authorities.

Sandwich Board Signs means a self-supporting, freestanding temporary sign with only two (2) sides that are situated adjacent to a business with the intent to attract pedestrian traffic to businesses. Sandwich board signs are not meant to be read by vehicular traffic.

Wall sign means any sign which is affixed to a wall of any building. This definition includes individual letter signs and signs on mansards.

Window sign means a sign installed inside a window, or any sign placed within a building for the purpose of being visible from the public right-of-way. This does not include merchandise on display.

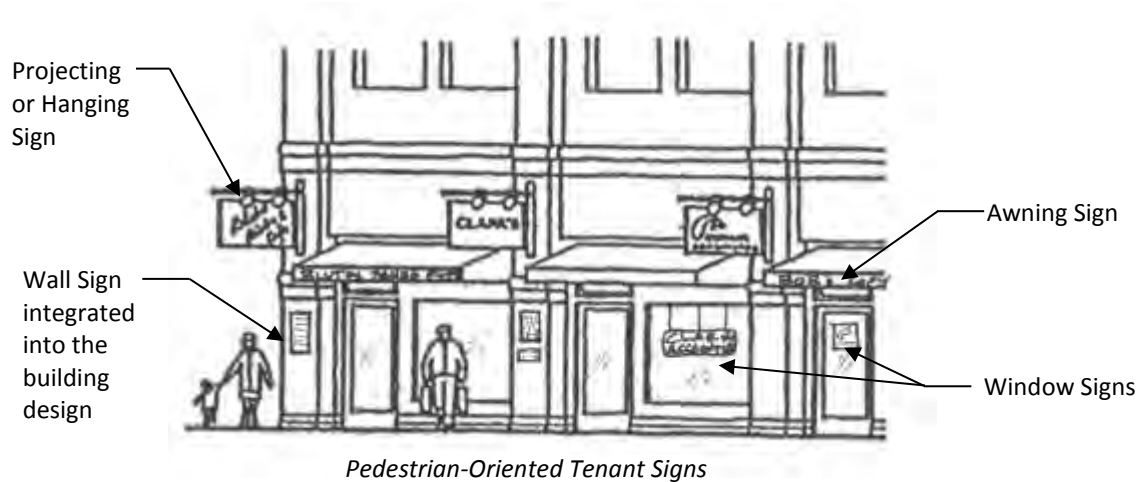

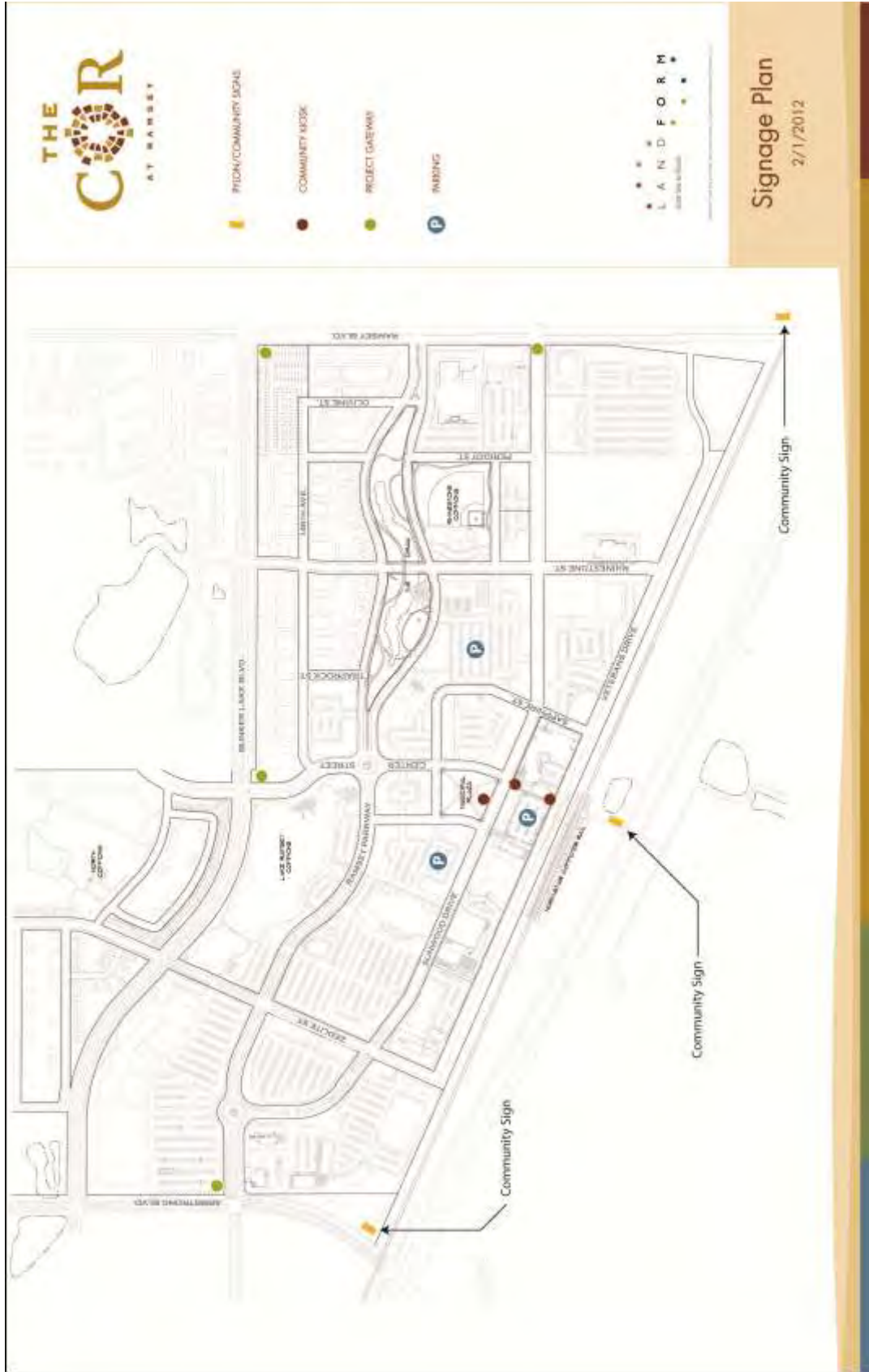

Figure 56: Signage Plan

Standards

Public Realm/Streetscape Signs

The pedestrian oriented nature of The COR requires unique signage that will build on the design concepts for The COR. These types of signs include banner signs on the streetlights, kiosks, street signs, wayfinding signs, signage for public parking ramps, etc. As the design concept for The COR has been refined, so has the signage plan. ~~The COR development manager shall develop standards for these public realm signs as part of the Master Sign Plan. The Master Sign Plan shall be incorporated by reference and may be updated from time to time. Such signage shall be allowed on public spaces as needed to provide information and wayfinding. No advertising shall be allowed on Public Realm/Streetscape Signs except for community events.~~ The Master Sign Plan is included as Appendix B. Size, location, and construction specifications of these signs shall be determined by the Master Sign Plan, which must be approved by the City Council, after a recommendation by the Planning Commission. Careful foresight has been given to size of signs based on needs of the adjacent roadways in order to maintain adequate safety standards that may otherwise be compromised by poor design. Roadways with higher speeds warrant larger lettering to maintain safe travel.

Community and Gateway signs

Community signs include are planned to include three (3) signs on Highway 10, as shown on the Signage Plan (see ~~Figure 5: Signage Plan~~ Figure 6: Signage Plan). The signs include the existing Community Sign near the future transit plaza, the sign at the northwest corner of Highway 10 and Ramsey Boulevard and the planned sign at the northwest corner of Highway 10 and Armstrong Boulevard.

Gateway signs are planned at multiple locations at entrances to The COR from major roadways, as shown on the Signage Plan. General gateway signs may identify The COR only. Retail Gateway signs may include provisions for off-premise, tenant sign panels.

These off-site signs, part of a unified development, are allowed as shown on the signage plan and shall have consistent materials and colors. ~~The Master Sign Plan shall detail the materials, colors and standards for these three (3) community signs. The Master Sign Plan shall include standards for which tenants shall be allowed on the community signs.~~ Community and Gateway Signs shall conform to the design of the Master Sign Plan. Tenants within the unified development shall be allowed to utilize tenant panels on the Community and Retail Gateway Signs.

Amendments to the Master Sign Plan and Approved Community Signs. As the Master Sign Plan is adopted as part of the zoning ordinance, and has the effect of being a zoning ordinance, amendments to the Master Sign Plan must be processed by Ordinance and approved by City Council after review and recommendation by the Planning Commission.

<u>Sign Type</u>	<u>Allowable Size</u>	<u>Architecture</u>	<u>Allowable Height</u>
<u>Community Sign</u>	<u>300 Square Feet</u>	<u>Per Appendix B</u>	<u>30 Feet *</u>
<u>Gateway Sign</u>	<u>50 Square Feet</u>	<u>Per Appendix B</u>	<u>10 Feet</u>
<u>Retail Gateway Sign</u>	<u>150 Square Feet</u>	<u>Per Appendix B</u>	<u>12 Feet</u>
<u>Community Kiosk</u>	<u>32 Square Feet</u>	<u>Per Appendix B</u>	<u>10 Feet*</u>
<u>Parking Ramp Signage</u>	<u>100 Square Feet</u>	<u>Per Appendix B</u>	<u>(Wall Signage)</u>

* From highest point of adjacent road centerline



Desirable signs are designed to be architecturally compatible with buildings within the development and other signage within the development

Project Signs

Project signs are permitted within all COR sub-districts.

One (1) freestanding sign is allowed per building, provided that the following standards are met:

- A. The building in which the advertising business is located, shall be set back a minimum of six (6) feet from a public street right-of-way.
- B. The area of each face of the signboard shall not exceed six (6) square feet and the signboard shall not have more than two (2) readable faces. The signboard may exceed six (6) square feet, but not more than 32 square feet, provided that the sign consists of individual letters, without internally illuminated box letters. Lighting may be achieved through 'halo' lighting effects.
- C. The height of the top of the signboard, or of any posts, brackets, or other supporting elements shall not exceed six (6') feet from the ground.
- D. The signboard shall be constructed of wood, acrylic, aluminum or metal and shall be architecturally compatible with the style, composition, materials, colors and details of the building.
- E. No part of the sign shall encroach on the right-of-way and its location shall not interfere with pedestrian or vehicular circulation.
- F. Limited to one (1) sign per building and shall not be in addition to wall-mounted, applied letter or projecting signs.

- G. The readable faces of the sign shall be perpendicular to the adjacent street.

In the COR2 District, the following signage shall be allowed:

- A. Ground sign. There shall not be more than one (1) ground sign for each parcel. The gross surface area of a ground sign shall not exceed one hundred (100) square feet for each exposed face nor exceed an aggregate gross surface area of two hundred (200) square feet. Ground signs may be shared and combined at areas of shared entrances for multiple users. Shared ground signs shall not exceed 150 square feet. A shared sign shall be allowed for each entrance to the site (defined as bordered by public streets).
- B. Menu board. One (1) on-site menu board per drive-up or walk-up lane of a drive-in restaurant up to a maximum of thirty-two (32) square feet each and a maximum height of three (3) feet. Menu boards are allowed a message on one (1) side only and cannot contain an advertising message.
- C. Directional signs.
 - 1. Directional or instructional signs are permitted in accordance with Section 117-463(I).
 - 2. Parking lot directional signs designating parking area entrances and exits are limited to one (1) sign for each entrance and/or exit and shall not exceed four (4) square feet for each exposed face. Parking lot directional signs shall not project higher than five feet (5') in height, as measured from the established grade of the parking area to which such signs are accessory.
 - 3. Parking lot instructional signs designating the conditions of use or identification parking areas shall not exceed eight (8) square feet and shall not project higher than ten (10) feet in height for wall signs and seven (7) feet in height for ground signs, as measured from the established grade of the parking area to which such signs are accessory.

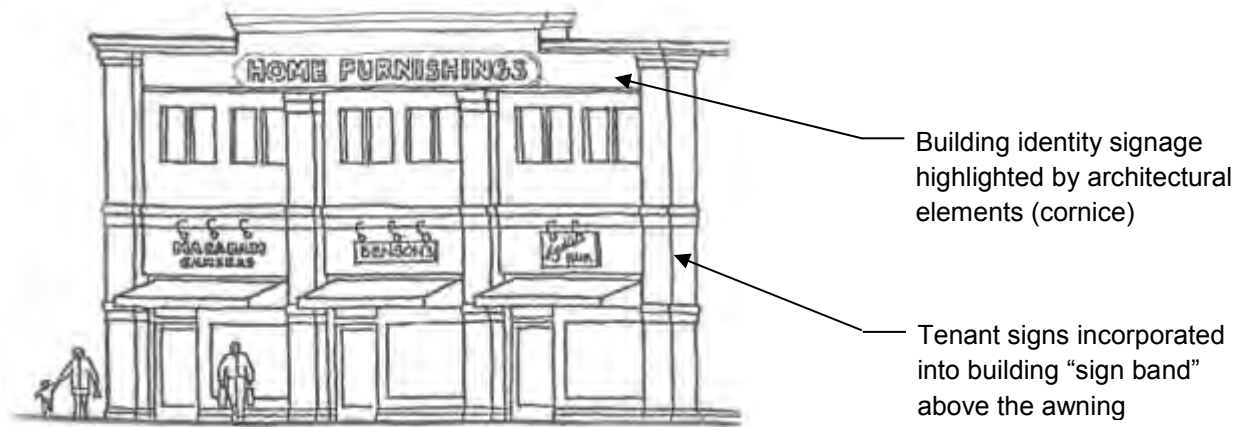

Wall Signs

Wall signs are permitted within all COR sub-districts.

Wall signs shall be permitted on one (1) wall, except that lots with frontage on more than one (1) street may have signage on one (1) wall per street frontage.

Within the COR1, COR3, COR4 and COR5 districts, the following standards apply:

- A. Wall-mounted or painted signs, provided the following standards are met:
 1. The sign shall be affixed to the front facade of the building, and shall project outward from the wall to which it is attached no more than six inches (6").
 2. Single Tenant Buildings. Each building shall be allowed one (1) wall sign per street frontage. Signage must be located on the street elevation. The area of the sign shall not exceed ~~five-fifteen (515%)~~ five-fifteen (515%) percent of the ground floor building facade area. ~~Individual signs may not exceed or fifty (50) square feet, whichever is less.~~
 3. Multi-Tenant Buildings.
 - a. Each building shall be allowed wall signage on the street frontage elevation. For buildings with multiple street frontages, the allowable signage is per street frontage. Signage must be located on the street elevation.
 - b. Each building is allowed wall signage that shall not exceed 5% of the wall area of the building façade adjacent to the street. ~~or Individual signs may not exceed 50 square feet, whichever is less.~~
 - c. Tenant signage must be located on the tenant lease space.
 - d. At least fifty (50%) percent of the allowed signage must be allocated to ground floor tenants and located on the ground floor.
 - e. Signage is limited to a maximum of one (1) sign per business/tenant, except that tenants with frontage on multiple streets may be permitted to have signage on each street frontage.
 - f. Multi-tenant buildings must have wall signs of similar design. Sign permits for

tenants in multi-tenant buildings shall only be permitted by the City after the building owner has submitted a comprehensive sign plan approved by the Zoning Administrator. The comprehensive sign plan for the building shall include similar design standards including sign material, color, style, spacing and size.

4. Signs for buildings facing Highway 10. Single or multi-tenant buildings that have frontage on Highway 10 or are separated from Highway 10 only by other public right-of-way, shall be allowed to have signage on that street elevation that is up to ~~five-fifteen~~ (5.15%) percent of the wall area of that building façade with no maximum square footage.
- B. Wall-mounted building directory signs identifying the occupants of a commercial building, including upper story business uses, provided the following standards are met:
1. The sign is located next to the entrance.
 2. The sign shall project outward from the wall to which it is attached no more than six inches (6").
 3. The sign shall not extend above the parapet, eave, or building facade.
 - ~~4. The area of the signboard shall not exceed three (3) square feet, with each tenant limited to one (1) square foot.~~
 - ~~5.4.~~ The height of the lettering, numbers, or graphics shall not exceed ~~four-twelve~~ (12.4") inches.
 - ~~6.5.~~ One (1) such sign is allowed per public building entrance and is allowed in addition to other permitted wall signage.
- C. Applied letters may substitute for wall-mounted signs, if constructed of painted wood, painted cast metal, bronze, brass, acrylic or black anodized aluminum. The height of applied letters shall not exceed 12 inches.
- D. Logos are considered signs and shall be included in the maximum allowable sign area.
- E. Window or door signs, provided that the following standards are met:
1. The sign shall not exceed ten percent of the window or door area or four (4) square feet, whichever is less.
 2. The sign shall be silk screened, hand painted, applied letters/graphics, neon tubing or other sign technologies that meet these standards.
 3. Limited to one (1) sign per business, applied on either the window or the door, but not on both.

4. The sign shall not have an opaque backing of any type although smoked glass is allowed.

5. Window signage (includes graphics) shall be permitted on the same building walls that have, or are allowed to have, wall signage pursuant to Item A above. Window signage shall be deducted from the allowable wall signage area.

Within the COR2 district, where more conventional suburban development is expected, rather than the neo-traditional development planned for the other COR sub-districts, the following standards apply:

- A. Wall, canopy or marquee sign. Total sign area may not exceed 15 percent of the front building facade. At least 50 percent of the signage area must be placed on the measured wall with remaining signage area, if desired, distributed on any other wall. Sign height shall not exceed the top of the parapet wall or, if no parapet wall, sign height shall not exceed the height of the eaves. The gross surface area of a wall, canopy or marquee sign may be increased by ten percent if such wall sign:
 1. Consists only of individual, outlined alphabetic, numeric and/or symbolic characters without background except that provided by the building surface to which the sign is to be affixed;
 2. Illumination, if any, is achieved through shielded illumination, shielded silhouette lighting, or shielded spot lighting but not any lighting where the light source is visible or exposed on the face or sides of the characters; and
 3. A wall, canopy or marquee sign may be located on the outermost wall of any principle building but shall not project more than 16 inches from the wall to which the sign is to be affixed. A wall sign shall not project higher than the parapet line of the wall to which the sign is to be affixed.
- B. Window signs are restricted to 30 percent of the area of the window in which the sign is to be displayed.

In all COR sub-districts, restaurants and cafes shall be permitted one (1) wall-mounted display featuring the actual menu as used at the dining table, to be contained within a shallow wood or metal case and clearly visible through a glass front. The display case shall be attached to the building wall, next to the main entrance, at a height of approximately five feet (5'), shall not exceed a total area of two square feet, and may be lighted. This signage is allowed in addition to other permitted wall signage.

Projecting Signs

Projecting signs are permitted within all COR sub-districts.

Projecting signs, including graphics or icon signs, mounted perpendicular to the building wall, are encouraged in all sub-districts, provided the following standards are met:

- A. The sign area shall not exceed ~~six~~sixty-two (632) square feet.
- B. The distance from the ground to the lower edge of the signboard shall be ten feet or greater.



- C. The height of the top edge of the signboard shall not exceed the height of the wall from which the sign projects, if attached to a single story building, or the height of the sill or bottom of any second story window, if attached to a multistory building.
- D. The distance from the building wall to the signboard shall not exceed six inches (6").
- E. The width of the signboard shall not exceed three (3) feet.
- F. Limited to one (1) sign per business. Projecting sign area shall be deducted from the allowable wall signage area.
- G. Granted to ground floor commercial uses only.

Awning Signs

Awning signs are allowed in all COR sub-districts. Awning signs are allowed for ground floor uses only, provided that the following standards are met:

- A. If acting as the main business sign, it shall not exceed 24 square feet in area, ~~and the height of the lettering, numbers, or graphics shall not exceed 12 inches.~~
- B. If acting as an auxiliary business sign, it shall be located on the valance only, shall not exceed four (4) square feet in area, and the height of the lettering, numbers, or graphics shall not exceed four inches (4").
- C. Limited to two such signs per business, per frontage.
- D. If acting as the main business sign, it shall not be in addition to a wall-mounted or applied letter sign.

Sandwich Board Signs

Sandwich board signs are permitted within all COR sub-districts.

- A. One (1) sandwich board sign per business is permitted in any business, commercial and mixed use district and shall be located within five feet (5') of the main building entrance to the business it advertises.
- B. Sandwich board signs shall be displayed only during open business hours and must be removed daily.
- C. Sandwich board signs shall be no more than a total of two feet (2') in width and three feet (3') in height



- D. Sandwich board signs must leave a minimum of five feet (5') of clearance for pedestrian access if placed on a public or private sidewalk. Sandwich board signs may not hinder the ability of persons to access vehicles parked at the curb and/or access to a building.
- E. Acceptable materials for sandwich board signs shall include the following: metal, wood synthetic materials such as a chalk board and whiteboard. Sandwich board signs shall not be illuminated, nor shall they contain moving parts, or have balloons, streamers, stringers, pennants or similar adornments attached to them. Sandwich board signs shall be maintained in a good appearance at all times.
- F. No sandwich board sign shall be secured, tethered or installed on traffic devices, utility equipment, street furniture, street lights, or any other public fixture.
- G. Sandwich board signs are temporary signs and shall not be counted towards the total sign area of the site for permanent signage.

Temporary Signs

Temporary signs are allowed per Section 117-465 (Temporary signs) of the Zoning Ordinance, except as noted below:

- A. Freestanding temporary signs shall only be allowed in the COR~~2~~ and COR3 Districts.
- B. In all other COR districts, temporary signs shall be limited to temporary sandwich board signs or temporary wall signage, without interchangeable letters.
- B-C. Real estate and leasing signs shall be exempt from temporary and permanent sign regulations, provided that these signs do not exceed thirty-two (32) square feet.

Off-Site Signs

Off-site signs are prohibited except for wayfinding and community signage specifically allowed by the Design Framework.

Table 2

Sign Standards					
Development Standard	COR1	COR2	COR3	COR4	COR5
Project Signs					
Number of signs allowed	1*	1*	1*	1*	1*
Size of Sign (maximum)	6 sq. ft./6 feet high***	100 sq. ft./6 feet high	6 sq. ft./6 feet high***	6 sq. ft./6 feet high	6 sq. ft./6 feet high
Menu Board**	N/A	1 per drive-through lane/36 40 sq. ft. max.	N/A	N/A	N/A
Directional Sign	N/A	Per 117-463(l)	N/A	N/A	N/A
Wall Sign					
Number of signs allowed	1*	1*	1*	1*	1*
Size of Sign					
Single Tenant Building	50 sq. ft. or 15% of the ground floor façade area, -or- 15% of the front façade area when facing Highway 10, whichever is less	15% of façade area	50 sq. ft. or 15% of the ground floor façade area, whichever is less	50 sq. ft. or 5% of the ground floor façade area, whichever is less	50 sq. ft. or 5% of the ground floor façade area, whichever is less
Multi-Tenant Buildings	50 sq. ft. or 15% of the façade area, whichever is less	15% of façade area	50 sq. ft. or 15% of the façade area, whichever is less	50 sq. ft. or 5% of the façade area, whichever is less	50 sq. ft. or 5% of the façade area, whichever is less
Building Facing Highway 10	15% of the façade area	15% of façade area	15% of the façade area	15% of the façade area	15% of the façade area
Window Sign					
Number of signs allowed	1	1	1	1	1
Size of Sign	10% of area of window or 4 sq. ft., whichever is less. Deducted from allowable wall sign area.	30% of area of window. Deducted from allowable wall sign area.	10% of area of window or 4 sq. ft., whichever is less. Deducted from allowable wall sign area.	10% of area of window or 4 sq. ft., whichever is less. Deducted from allowable wall sign area.	10% of area of window or 4 sq. ft., whichever is less. Deducted from allowable wall sign area.
Directory Sign					
Number of signs allowed	1 per building entrance	1 per building entrance	1 per building entrance	1 per building entrance	1 per building entrance
Size of Sign	3 sq. ft. maximum	3 sq. ft. maximum	3 sq. ft. maximum	3 sq. ft. maximum	3 sq. ft. maximum
Projecting Sign					
Number of signs allowed	1*	1*	1*	1*	1*
Size of Sign	6 sq. ft./3 feet wide	6 sq. ft./3 feet wide	6 sq. ft./3 feet wide	6 sq. ft./3 feet wide	6 sq. ft./3 feet wide
Awning Sign					
Number of signs allowed	2 per business	2 per business	2 per business	2 per business	2 per business
Size of Sign	24 sq. ft./max. letter height 12-inches for main business sign or 4 sq. ft./max letter height 4-inches if auxiliary. Area is deducted from allowable wall sign area.	24 sq. ft./max. letter height 12-inches for main business sign or 4 sq. ft./max letter height 4-inches if auxiliary. Area is deducted from allowable wall sign area.	24 sq. ft./max. letter height 12-inches for main business sign or 4 sq. ft./max letter height 4-inches if auxiliary. Area is deducted from allowable wall sign area.	24 sq. ft./max. letter height 12-inches for main business sign or 4 sq. ft./max letter height 4-inches if auxiliary. Area is deducted from allowable wall sign area.	24 sq. ft./max. letter height 12-inches for main business sign or 4 sq. ft./max letter height 4-inches if auxiliary. Area is deducted from allowable wall sign area.

*One (1) sign is allowed per street frontage (either wall or project)

**Restaurants and cafes in all districts are allowed one (1) wall mounted menu board not to exceed 2 sq. ft. in addition to other permitted wall signage.

***See Page 32, 'Project Signs' for allowances up to 32 square feet.

Additional standards

- A. Businesses with service entrances may identify these with one (1) wall-mounted or applied letter sign not exceeding two square feet.
- B. One (1) directional sign, facing a rear parking lot. This sign may be any type of permitted sign other than a freestanding sign, but shall be limited to four (4) square feet in area.

Creative Sign Standards

- A. *Purpose.* This section establishes standards and procedures for the design, review, and approval of creative signs. The purposes of this creative sign program are to:
 - 1. Encourage signs of unique design, and that exhibit a high degree of thoughtfulness, imagination, inventiveness, and spirit; and
 - 2. Provide a process for the application of sign regulations in ways that will allow creatively designed signs that make a positive visual contribution to the overall image of the city, while mitigating the impacts of large or unusually designed signs.
- B. *Applicability.* An applicant may request approval of a sign permit for a creative sign to authorize onsite signs that employ standards that differ from the other provisions of this chapter but comply with the provisions of this section.
- C. *Application Requirements.* A sign permit application for a creative sign shall include all information and materials required by the City.
- D. *Procedure.* A sign permit application for a creative sign shall be subject to review and approval by the City as part of the Site Plan review process. When the creative sign is proposed after site plan review is complete, a creative sign may be approved by the Zoning Administrator when the proposed sign is fifty square feet or less, and shall be approved by the City Council when the sign is larger than fifty square feet.
- E. *Design Criteria.* In approving an application for a creative sign, the review authority shall ensure that a proposed sign meets the following design criteria:
 - 1. Design Quality. The sign shall:
 - a. Constitute a substantial aesthetic improvement to the site and shall have a positive visual impact on the surrounding area;
 - b. Be of unique design, and exhibit a high degree of thoughtfulness, imagination, inventiveness, and spirit; and
 - c. Provide strong graphic character through the imaginative use of graphics, color, texture, quality materials, scale, and proportion.
 - 2. Contextual Criteria. The sign shall contain at least one (1) of the following elements:
 - a. Classic historic design style;

- b. Creative image reflecting current or historic character of the City;
 - c. Inventive representation of the use, name, or logo of the structure or business.
3. Architectural Criteria. The sign shall:
- a. Utilize or enhance the architectural elements of the building; and
 - b. Be placed in a logical location in relation to the overall composition of the building's façade and not cover any key architectural features and details of the façade.
4. Neighborhood Impacts. The sign shall be located and designed not to cause light and glare impacts on neighboring residential uses.

Prohibited signs

The following signs are prohibited:

- A. Box signs or cabinet signs, whether on a wall, projecting or on canopies are prohibited except for logo signs permitted as part of an overall sign plan.
- B. Signs employing mercury vapor, low pressure and high pressure sodium and metal halide lighting; plastic panel rear-lighted signs.
- C. Signs on roofs, dormers, and balconies.
- D. Billboards.
- E. Signs painted or mounted upon the exterior side or rear walls on any principle or accessory building or structure, except as otherwise permitted hereunder.
- F. Free standing pylon signs over six (6) feet in height, except community signs.
- G. Back-lit awnings.
- H. Interchangeable letter boards or panels.
- I. Flashing signs.
- J. Off-premises signs, except community signs.

This page intentionally left blank.

Overall Framework – Stormwater Management

Overview

Water features and drainage systems are essential components of The COR Master Plan. The mix of ponds, streams, fountains and other water elements will provide focal amenities and year round activities within the framework of an environmentally responsible, visually pleasing strategy to manage stormwater. Because the Mississippi River is a restricted discharge water of the state, and because we are creating a new discharge from this development, each sub-district and each site has a responsibility to utilize ‘best management practices’ (BMP) to pretreat run-off, reduce erosion and encourage infiltration, with the understanding that regional treatment will be provided. Water elements are not intended to be separate stand-alone features, but instead should be integrated with the variety of parks, trails and public open space proposed for The COR. Water and landscape should be designed and utilized within multipurpose areas that accommodate both active and passive recreational use.

Objectives

Integration of water and landscape, design creativity, use of high quality materials and safety concerns are the critical objectives to be met – the following examples illustrate only a few of many possibilities:

- Innovative new products, such as special soil systems (Netlon, structural soils), pervious pavements for parking areas, storm ceptors, underground storage and other creative techniques should be used to BMP standards
- ‘Green architecture’, expressed through green roofs, gray water recycling and other techniques should be included to reduce the impact of new development on stormwater systems
- Water feature design should include both formal elements (such as reflecting pools or fountains) and natural/informal forms (such as ponds, streams, waterfalls) and should explore creative ways to integrate wetland/rain garden landscapes with active, urban spaces.

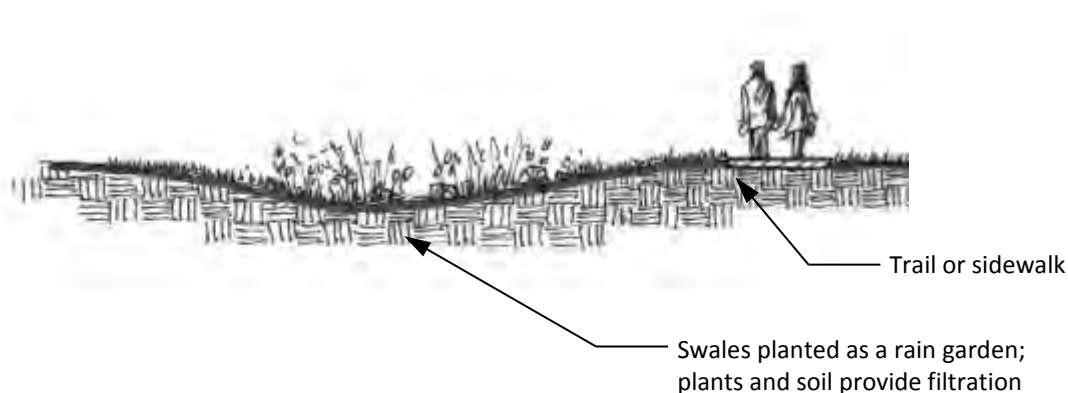

Guideline Recommendations

This framework not only defines the overall role and character of The COR, but also encourages each development parcel to address the following:

- **Create** signature water features (ponds, pools, fountains, waterfalls, etc.) as major visual amenities throughout The COR
- **Promote** high quality, creative and appealing aesthetics for all system elements
- **Integrate** stormwater management components (meeting both water quality and quantity requirements)

A great deal of time and effort has gone into the calculation and design of a 'watershed-based' stormwater management plan to support COR development. While this overall strategy addresses the water quantity issue for the entire COR by providing storage and conveyance facilities for storm events, individual development projects (block-by-block) have an equal responsibility to meet water quality standards as a primary goal. Each project should integrate a variety of techniques, materials and methods to promote multiple use, maximum flexibility, improved aesthetics for parking areas, park spaces, drainage swales and other site features.

Overall Framework – Parks/Public Spaces

Overview

The overall design framework of The COR is based on a system of linked parks, trails and open space. The City of Ramsey, Anoka County, and to some extent, the State of Minnesota all play a role in local and regional parks programming, design review, construction sequencing, implementation and ultimately maintenance and operation of key public spaces within this framework. The goal is to link existing and proposed parks and trails defined in regional park plans with proposed new parks and trails within The COR. Of equal importance is the contribution from each block and each development project to this network of green, adding a variety of private, semi-private, and perhaps some additional public space throughout The COR. Private development will share the responsibility to provide inviting, innovative and useable green space as integral parts of individual parcel site design.

Guideline Recommendations

The Design Framework encourages the following:

- Work with the City to create an integrated, comprehensive open space system that links with existing city and county trails and open space networks
- Encourage private development (block-by-block) to share in the responsibility to provide inviting, innovative and useable green space as integral parts of each development project
- Integrate stormwater management components (meeting water quality and quantity requirements) within both public / private park and open space improvements



Together, the system of public and semi-public green space will result in a welcoming public realm throughout the new community.

Objectives

Based on the Development Master Plan for The COR, a variety of public and private green space is proposed including:

- Each block and each project will provide intentional, creative, innovative, useable green areas as integral components of site development and building design.
- At the individual block scale, small squares and greens will provide places for gathering and relaxation, especially targeted to meet the demands of adjacent, or nearby buildings. Elements such as gardens, gazebos and fountains should characterize these more intimate public spaces.
- At the neighborhood scale, parks will provide space for more active recreation, and should be flexible enough to accommodate a variety of recreational activities.
- Playgrounds, game fields and park buildings are park amenities that will target a wider user demand from the surrounding community.
- The Municipal Plaza will connect with all other parks and open space elements, providing a focal point for activity and a sense of place. Gardens, public pavilions and shelters, play lots and open play fields are amenities that will provide built-in flexibility to meet the demands of both the local population and regional visitors to The COR.



Regional Systems

The COR is the heart of several regional systems that are either located within or adjacent to The COR. These regional systems include the Northstar Commuter Rail, the Central Anoka County Regional Trail, the Mississippi West Regional Park, and the Mississippi River Trail.

A number of these systems have a pedestrian component. As such, Ramsey desires to locate the future Central Anoka County Regional Trail through the heart of The COR, along Center Street. The map below indicates Ramsey's preferred route for this trail. As this trail requires crossing Highway 10, it is imperative that a safe, grade-separated crossing is realized. This pedestrian overpass is envisioned to be connected to the Northstar Commuter Rail – Ramsey Station, and has been named the 'Mississippi Skyway'.

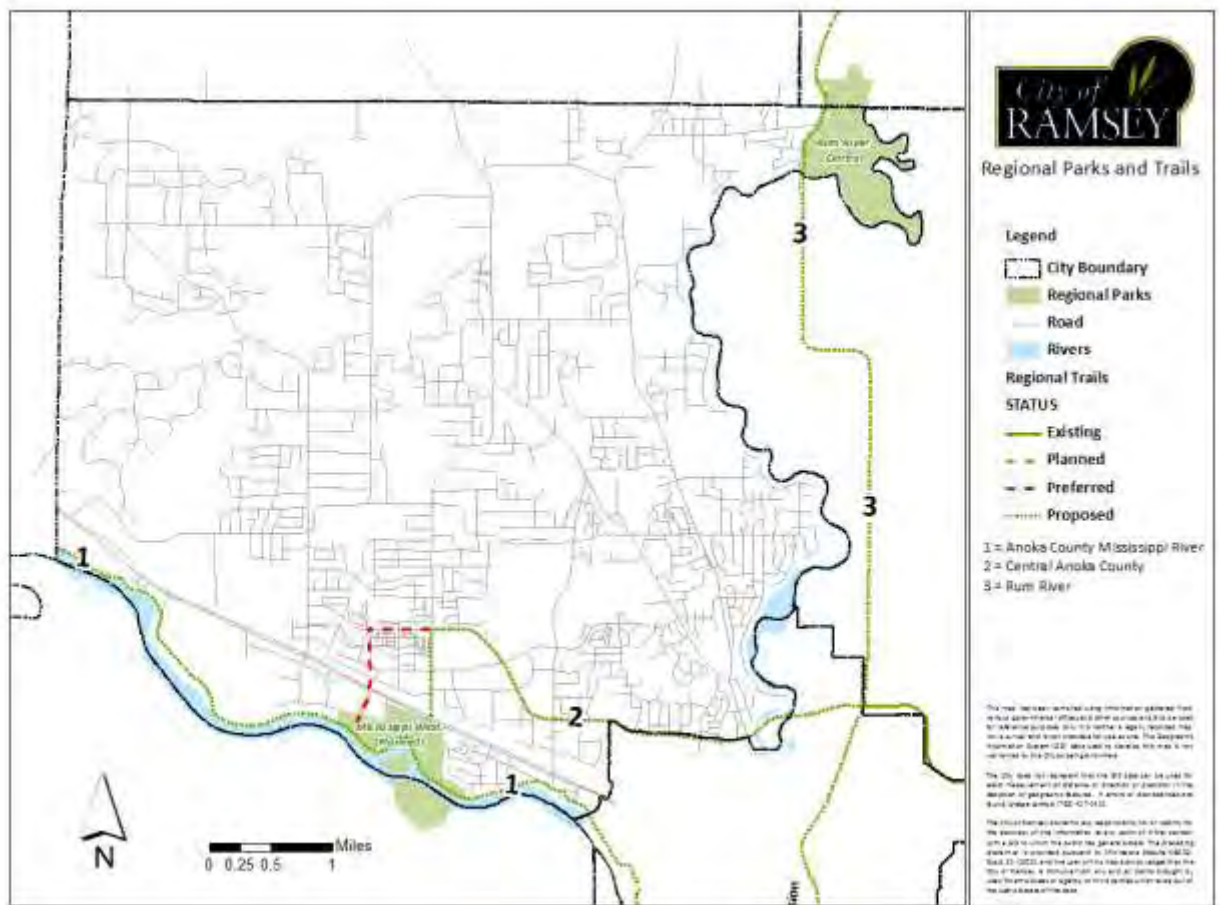

Part Two: Sub-district Framework

Overview

The Master Plan and Zoning Ordinance identify five (5) distinct sub-districts within The COR. Each of these sub-districts is defined by a unique mix of uses, specific site development patterns and perhaps a distinctive character or image. The sub-districts complement one another as part of the overall plan. The sub-districts are shown the attached Sub-district Map (~~Error! Reference source not found.Figure 7: Sub-district Map~~). They include:

- **COR1 Mixed Use Core** – provides the broadest variety, highest density and greatest intensity of development, encouraging both vertical and horizontal mixed use
- **COR2 Commercial** – provides a location for larger scale retail and other auto-orientated commercial uses
- **COR3 Workplace** – provides a location for uses with high concentrations of employees, such as medical/technology related office, and other corporate or institutional uses
- **COR4 Neighborhood** – provides opportunities for a range of housing types from small lot single family to townhouse, to high density senior or rental apartment
- **COR5 Park and Open Space** – preserves environmental features and provides neighborhood/community amenities throughout The COR

Development plans must respond to the overall COR Design Framework described in Part One of this document, but also must address the following detailed framework standards for each sub-district. To further clarify and illustrate proposed features in the Master Plan, these sub-district guidelines are organized under the following categories:

- Public Realm / Streetscape Framework
- Site Design Framework
- Architectural Framework

In all cases, the sub-district framework must be applied in harmony with the overall COR framework and with other existing city, county, state codes, design criteria, plans and studies that support broader goals for regional growth and development. However, within each district, development standards shall be based, in part, on the street hierarchy established in The COR.

Public Realm/Streetscape

- A. The developer shall be responsible for construction of all streetscape improvements along adjacent streets. These improvements include all hardscape improvements, such as trails, sidewalks, benches, bike racks, etc., as well as street trees and other greenscape.
- B. The landowner shall be responsible for maintenance of the streetscape improvements along adjacent streets. Such maintenance may be managed as part of a Special Service District (SSD) or similar.

Plazas

- A. All properties with principal buildings in excess of 30,000 square feet shall be required to have a public plaza space.

- B. The public plaza space shall include benches, bike racks trash receptacles, lighting fixtures and other amenities to create a welcoming space for tenants of the building and members of the public.
- C. These plaza spaces should be visible from the public street.

Architecture

These architectural framework standards provide an important balance between design continuity, desirable variety and the notion that buildings should complement, and perhaps contrast, but not compete with one another. The lasting appeal of the final outcome must be grounded in the authenticity of the design and the acceptable level of ‘messiness’ that comes with creating a real downtown over time; ‘faux’ second floors, stage set or themed solutions, and large faceless buildings are not acceptable.



Auto Versus Human Design: Providing rear alleys or side loaded garages enables the home to present itself to the street, which promotes sociability and walkability.

Minimum Standards

Definitions

Build to line: The line at which construction of a building facade is to occur on a lot. The build to line provides a maximum setback for all building facades from the right-of-way or inside edge of the sidewalk, whichever is greater. The build to line applies to all facades abutting a street right of way. Build to line standards are based on the sub-district the parcel is located and the street in which the building is located upon.

Setback: The minimum required distance between a parking lot or the vertical wall of a building and a lot line. Setbacks are typically more flexible than build to lines and allow a building to be set further back from the lot line and street right-of-way.

Requirements:

- A. Additional development standards shall be defined within each sub-district.

- B. Provide a diverse mix of materials, applied in a variety of proportions, exposures and detailing within a block, or along a street.
- C. Buildings should be articulated to break up the mass of the building façade on all elevations. Large blank exterior walls shall be prohibited. Windows are encouraged to be used to break up the mass of the building. Rooflines and building elevations should be articulated to break up the mass of buildings. Buildings must be broken at a minimum of every fifty (50) feet. This variation can be accomplished through one (1) or more of the following:
 1. Wall face variations (minimum depth of two (2) feet)
 2. Pilasters or columns (minimum depth of two (2) feet)
 3. Upper wall break in color and/or materials (minimum of 2/3 up the height of the wall)
 4. Wainscot (minimum of four (4) feet high)
 5. Canopies (minimum four (4) foot width)
 6. Corner and demising wall or building separations



More Desirable

- D. Each development application must list building materials, roofing materials and building colors on the plans. Building articulation, mechanical screening by architectural elements and design elements on all building elevations must be identified on the plans. The plans shall be subject to City review and approval to ensure that the design intent of the Framework has been met.



Less Desirable

- E. Building materials shall be high-quality durable materials, such as glass, stone, brick, windows, canvas awnings, etc.
 1. Use local sources if available
 2. Siding is not allowed (vinyl, metal, wood) except as a complimentary use
 3. Use clear or lightly tinted glass for all windows and doors – mirrored, reflective or highly tinted glazing is not acceptable
 4. Metal and wood components are acceptable as a complimentary, not primary, building material
 5. COR1 sub-district buildings shall be primarily brick or a comparable alternative and shall comprise a minimum of fifty (50%) percent of the non-glazed wall area
- F. Residential development should provide variety within the subdivision to avoid monotony. Developers will include front porches and windows that face all streets. Corner units shall have more than one (1) window per side of building to help create a sense of place in the community and promote safety on the street.
- G. Garage forward or “snout houses” are highly discouraged on all residential development as they dominate the view from the street and sidewalk.
- H. All sides of buildings shall have an equal finish in terms of materials and general design.

I. The main entrance of each principal building must face the street. On corner lots, the main entrance may face either of the streets or be oriented to the corner. With buildings that have more than one (1) main entrance, only one (1) entrance must meet this requirement.



J. Building massing shall be oriented parallel to the street frontage of the lot.

K. Trash and recycling areas shall be designed internal to the building.

L. Provide recessed entries wherever possible.

M. Buildings shall have a base and top to the architecture.

N. Multi-story buildings are preferred in the COR1 sub-district, but occasional single story buildings are acceptable; single story buildings should not dominate any street frontage and should be a minimum of twenty (20) feet to the roofline.



O. Maximize glass openings for all ground level, street front façades – especially for retail, restaurant and other commercial uses – fifty (50%) minimum of total ground level façade, or demonstrate great design through other means.

P. Provide real window openings for all street facing façades above ground level in all districts—a minimum of forty (40%) percent of total façade.

Residential uses in COR4 and COR5 must also comply with the following:

A. *Location of main entrance*

1. A building must include a front porch or covered balcony/patio at all main entrances that face a street. The porch or stoop shall adjoin the main entrance and the main entrance shall be accessible from the porch.
2. The main entrance of each principal building must face the street. On corner lots, the main entrance may face either of the streets or be oriented to the corner. With buildings that have more than one (1) main entrance, only one (1) entrance must meet this requirement.



B. *Porches:* Porches used to satisfy the design criteria shall comply with the following:

1. Porches shall be covered by a solid roof. The roof shall not

be located more than 12 feet above the floor of the porch. If the roof of a required porch is developed as a deck or balcony, it may be flat.

2. The porch shall have minimum dimensions of 6 feet by 6 feet. (6' x 6'). For single-family detached dwelling units, the covered area provided by the porch must be at least forty-eight (48) square feet and a minimum of eight (8) feet wide. If the main entrance is for more than one (1) dwelling unit, the covered area provided by the porch must be at least sixty-three (63) square feet and a minimum of nine (9) feet wide.



- C. *Covered balconies/patio*: The covered area must be at least forty-eight (48) square feet, a minimum of eight (8) feet wide, and no more than fifteen (15) feet above grade. The covered area must be accessible from the interior living space of the house.

- D. *Openings between porch floor and ground*: Openings of more than one (1) foot between the porch floor and the ground must be covered with a solid material or lattice.



E. *Roofs*

1. *Slope*: Principal structures must have a roof that is sloped, with a pitch that is no flatter than six (6) units of horizontal run to twelve (12) units of horizontal rise.
2. *Architectural features*: The roof of a principal structure shall include the following architectural details:
 - a. At least one (1) dormer facing the street. If only one (1) dormer is included, it shall be at least five (5) feet wide and shall be centered horizontally between each end of the front elevation. If more than one (1) dormer is provided, a dormer at least four (4) feet wide must be provided on each side of the front elevation; or
 - b. A gabled end, or a gabled end of a roof projection, facing the street.
3. *Roof eaves*: Roof eaves must project from the building wall at least twelve (12) inches, measured horizontally, on at least the front and side elevations.



Sub-District Framework - COR1 Mixed Use Core

Public Realm / Streetscape

Public realm and streetscape improvements define the character of The COR and create a memorable signature for the Mixed Use Core sub-district. This is the most urban of all sub-districts in The COR and will be developed with a very urban pattern. Great parks and great streets, encourage intensified levels of activity, support the proposed mix of uses, invite community gathering and accommodate special events throughout the year.

Site Development

Framework standards that address building location, organization of space and parking options tend to focus on what can be measured – dimensions, setbacks, number of spaces and so on. But in addition to these issues, the Design Framework also describes the aesthetic qualities and design character of a preferred ‘urban form’ for the Mixed Use Core. The compact and higher density blocks that define this sub-district encourage a mix of uses, with a continuous built edge along street frontage. Innovative parking strategies support this mix, providing easy access to destination shopping, restaurant and entertainment venues. Together these elements will promote the core area as the center of activity – the place to see and be seen within The COR.

Architecture

Buildings in the Mixed Use Core will play a major role in defining the overall character of The COR. The proposed mix of uses for this signature destination suggests the potential for a variety of building types, demanding creativity and innovation to highlight unique architecture, while knitting the entire sub-district together as a coherent whole. Overall building design is an important consideration, but emphasis on first floor façade treatments is essential to encourage street-level activity and enhance the pedestrian experience. Architecture to be ‘4-sided’ at all locations visible to public areas. Emphasis will be on great design along public street frontage.

Table 3

COR1 Development Standards						
	Arterial Street	Destination Street	Parkway	Connector Street	Downtown Street	Local Street
Minimum lot size	None	None	None	None	None	None
Minimum lot width	20 feet	20 feet	20 feet	20 feet	20 feet	20 feet
Minimum lot depth	80 feet	80 feet	80 feet	80 feet	80 feet	80 feet
Allowable residential density in dwelling units per acre ⁽¹⁾	>15 DU/AC	>15 DU/AC	>15 DU/AC	>15 DU/AC	>15 DU/AC	>15 DU/AC
Minimum floor area ratio (FAR) for nonresidential uses/vertically mixed buildings/sites	.75	.75	.75	.75	.75	.75
Build to Line						
Front yard ⁽⁴⁾	30 feet as measured from building front to right-of-way ⁽²⁾⁽³⁾ (60% of front facade w/in max.)	5 feet as measured from building front to right-of-way ⁽²⁾ (60% of front facade w/in max.)	5 feet as measured from building front to right-of-way ⁽²⁾ (60% of front facade w/in max.)	5 feet as measured from building front to right-of-way ⁽²⁾ (60% of front facade w/in max.)	5 feet as measured from building front to right-of-way ⁽²⁾ (60% of front facade w/in max.)	5 feet as measured from building front to right-of-way ⁽²⁾ (60% of front facade w/in max.)
Side yard	no req.	no req.	no req.	no req.	no req.	no req.
Rear yard	no req.	no req.	no req.	no req.	no req.	no req.
Driveway length (minimum)	25 feet for residential units	25 feet for residential units	25 feet for residential units	25 feet for residential units	25 feet for residential units	25 feet for residential units
Building height (min. - max.)	2 - 5 stories.	2 - 5 stories.	2 - 5 stories.	2 - 5 stories.	2 - 5 stories.	2 - 5 stories.
Planter Style	N/A	Planter Bed	Boulevard Sod	Boulevard Sod	N/A	Boulevard Sod
Tree Spacing (on center)	N/A	35 feet	35 feet	35 feet	35 feet	35 feet
Boulevard Width	N/A	6 feet	6 feet	6 feet	N/A	6 feet
Sidewalk Width	10 feet	10 feet	6 feet	10 feet	10 feet	10 feet

1. Residential density is based on the net area of the parcel in question for parcels. In the event that public open space that is not dedicated to the City is developed independently of any particular residential project, the land area of the open space shall be divided equally among those abutting projects for purposes of density calculations.
2. Build to line shall be measured from building front to edge of right-of-way, or edge of sidewalk easement as defined by the City and said sidewalk must be encumbered by a sidewalk easement recorded with the office of the Anoka County Recorder.
3. The City may approve up to a 60-foot setback if it finds that topography or other factors require that a building be set back further to achieve acceptable grades or buffer between the street, the site entrance and the building.
4. In order to address vision clearance standards on higher speed roadways, parcels that are located at an intersection with an arterial roadway are allowed a build-to line of 35 feet from both streets.

A. At least sixty (60%) percent of street frontage of any lot shall be occupied by building facades meeting this build-to-line. On lots with more than one (1) street frontage, the build to line shall apply on each side fronting a street. An enclosed open area plaza space or outdoor seating with a decorative wall with a minimum height of three feet (3') and a maximum of four and one-half feet (4 ½') can be used to meet the sixty (60%) percent street frontage requirement.

B. Screening Of Parking Areas: Wherever a surface parking area faces a street frontage, such frontage shall be screened with a decorative wall, railing, hedge, or a combination of these elements, to a minimum height of three feet (3') and a maximum height of four and one-half feet (4 ½') above the level of the parking lot, at the build-to line. This screening may be broken into sections along the street edge provided it meets the sixty (60%) percent required.

Sub-District Framework - COR2 Commercial

Public Realm / Streetscape

While the Commercial Sub-district encourages a mix of large and small floor plates accommodating auto-oriented uses, this suggests even greater attention be paid to public realm and streetscape improvements that not only accommodate vehicles, but also invite bicycle and pedestrian traffic. Surface parking lots provide convenient access to storefronts, but present an additional challenge to the overall visual character and aesthetic appeal of this area. While no large public parks are identified for this sub-district, small pocket parks, squares or other gathering spaces are encouraged. A consistent, attractive streetscape is also essential.

Site Development

Site Design Framework for this sub-district focus on a unique opportunity to recast typical commercial development patterns into a contemporary and innovative strategy that responds to overall objectives for The COR. Specifically, this suggests that the majority of buildings front on the primary through streets, with parking and service areas on the side or in the back, away from view. However, the market realities suggest that the types of auto-oriented users in this district will have the potential for larger parking fields and drive-throughs that will make a true urban model challenging. The City will hold all users to this design vision while modifying the COR2 standards slightly to accommodate these types of more typical suburban land uses. A mix of uses within individual blocks, including retail, restaurant and residential, further enhances this model, addresses design character/aesthetics and promotes activity throughout much of the day and evening hours.

Architecture

Buildings in the Commercial Sub-district make a significant contribution to first impressions of The COR. Buildings form gateways at the major entries into the site, architectural elements and choice of materials convey a certain character and the scale or massing of structures begins to define the feel or experience of this place. These are not just 'commodity' buildings, but instead should raise the bar in terms of overall design and specific details that make The COR unique, inviting and memorable. Architecture to be '4-sided' at all locations visible to public areas. Emphasis will be on great design along public street frontage.

Table 4

COR2 Development Standards						
	Arterial Street	Destination Street	Parkway	Connector Street	Downtown Street	Local Street
Minimum lot size	None	None	None	None	None	None
Minimum lot width	80 feet	80 feet	80 feet	80 feet	80 feet	80 feet
Minimum lot depth	100 feet	100 feet	100 feet	100 feet	100 feet	100 feet
Allowable residential density in dwelling units per acre ⁽¹⁾	>15 DU/AC	>15 DU/AC	>15 DU/AC	>15 DU/AC	>15 DU/AC	>15 DU/AC
Build to Line						
Front yard ⁽⁴⁾	30 feet as measured from building front to right-of-way ⁽²⁾⁽³⁾ (40% of front facade w/in max.)	15 feet as measured from building front to right-of-way ⁽²⁾ (40% of front facade w/in max.)	30 feet as measured from building front to right-of-way ⁽²⁾⁽³⁾ (40% of front facade w/in max.)	15 feet as measured from building front to right-of-way ⁽²⁾ (40% of front facade w/in max.)	15 feet as measured from building front to right-of-way ⁽²⁾ (40% of front facade w/in max.)	15 feet as measured from building front to right-of-way ⁽²⁾ (40% of front facade w/in max.)
Side yard	no req.	no req.	no req.	no req.	no req.	no req.
Rear yard	no req.	no req.	no req.	no req.	no req.	no req.
Driveway length (minimum)	25 feet for residential units	25 feet for residential units	25 feet for residential units	25 feet for residential units	25 feet for residential units	25 feet for residential units
Building height (min. - max.)	1-4 stories.	1-4 stories.	1-4 stories.	1-4 stories.	1-4 stories.	1-4 stories.
Planter Style	N/A	Boulevard Sod	Boulevard Sod	Boulevard Sod	N/A	Boulevard Sod
Tree Spacing (on center)	N/A	35 feet	35 feet	35 feet	35 feet	35 feet
Boulevard Width	N/A	6 feet	6 feet	6 feet	N/A	6 feet
Sidewalk Width	10 feet	6 feet	6 feet	10 feet	10 feet	10 feet

1. Residential density is based on the net area of the parcel in question for parcels. In the event that public open space that is not dedicated to the City is developed independently of any particular residential project, the land area of the open space shall be divided equally among those abutting projects for purposes of density calculations.
2. Build to line shall be measured from building front to edge of right-of-way, or edge of sidewalk easement as defined by the City and said sidewalk must be encumbered by a sidewalk easement recorded with the office of the Anoka County Recorder.
3. The City may approve up to a 60-foot setback if it finds that topography or other factors require that a building be set back further to achieve acceptable grades or buffer between the street, the site entrance and the building.
4. In order to address vision clearance standards on higher speed roadways, parcels that are located at an intersection with an arterial roadway are allowed a build-to line of 35 feet from both streets.

- A. At least forty (40%) percent of street frontage of any lot shall be occupied by building facades meeting this build-to-line. On lots with more than one (1) street frontage, the build to line shall apply only to one (1) street frontage.
1. An enclosed open area plaza space or outdoor seating with a decorative wall with a minimum height of three feet (3') and a maximum of four and one-half feet (4 ½') can be used to meet the forty (40%) percent street frontage requirement.
 2. The City may approve a variation from the required build to line if the applicant provides a street edge consisting of fencing, decorative wall and/or landscaping with a minimum height of three feet (3') and a maximum of four and one-half feet (4 ½') can be used to meet the forty (40%) percent street frontage requirement.

B. Screening Of Parking Areas: Wherever a surface parking area faces a street frontage, such frontage shall be screened with a decorative wall, railing, hedge, or a combination of these elements, to a minimum height of three feet (3') and a maximum height of four and one-half feet (4 ½') above the

level of the parking lot, at the build-to line. This screening may be broken into sections along the street edge provided it meets the forty (40%) percent required on all street frontages.

Sub-District Framework - COR3 Workplace

Public Realm/Streetscape

The Workplace Sub-district also encourages a mix of large and small floor plate buildings, but instead of commercial or entertainment, this area of The COR is dominated by office and institutional uses. With opportunities for corporate or medical campus development comes the attendant auto-related infrastructure – easy access, bigger streets and large surface parking lots. Once again, this suggests that equal attention be paid to public realm and streetscape improvements that not only accommodate vehicles, but also invite bicycle and pedestrian traffic. The Draw, an active, neighborhood scale, recreational play space has been included in this sub-district, but small pocket parks, squares or other gathering places are also encouraged. In addition, streetscape improvements provide an important public amenity and inviting pedestrian connection to adjacent sub-districts.

Site Development

The mix of medical, office, institutional and other uses in this sub-district suggest the potential for a campus-like arrangement of buildings on some blocks. These blocks would tend to be more internally oriented than in other districts, with driveways, parking lots, courtyards and walkway connections in the center, ringed by buildings around the outside. Buildings would still face adjacent streets, with both primary and secondary entries provided to animate these important façades, particularly along Ramsey Boulevard, Sunwood Drive and Rhinestone Street. While the Workplace sub-district also encourages mixed use, this desired development objective will likely occur mostly within blocks, not within individual buildings as seen in other districts.

Architecture

Buildings in the Workplace Sub-district also make a significant contribution to first impressions as people enter The COR via Highway 10, Ramsey Boulevard and Sunwood Drive. Buildings form gateways at the major entries into the site, architectural elements and choice of materials convey quality and permanence, and the scale or massing of structures begins to define the feel and character of this place. The proposed mix of uses within this sub-district suggest a variety of potential building types – blending medical campus with small office, storefront and some housing -- demands design creativity and innovation to highlight unique architecture, and knit the entire sub-district together as a coherent whole. Architecture to be '4-sided' at all locations visible to public areas. Emphasis will be on great design along public street frontage.

Table 5

COR3 Development Standards						
	Arterial Street	Destination Street	Parkway	Connector Street	Downtown Street	Local Street
Minimum lot size	None	None	None	None	None	None
Minimum lot width	40 feet	40 feet	40 feet	40 feet	40 feet	40 feet
Minimum lot depth	80 feet	80 feet	80 feet	80 feet	80 feet	80 feet
Allowable residential density in dwelling units per acre ⁽¹⁾	none	none	none	none	none	none
Minimum floor area ratio (FAR) for nonresidential uses/vertically mixed buildings/sites	.25	.25	.25	.25	.25	.25
Build to Line						
Front yard ⁽⁴⁾	30 feet as measured from building front to right-of-way ⁽²⁾⁽³⁾ (60% of front facade w/in max.)	15 feet as measured from building front to right-of-way ⁽²⁾ (60% of front facade w/in max.)	15 feet as measured from building front to right-of-way ⁽²⁾ (60% of front facade w/in max.)	15 feet as measured from building front to right-of-way ⁽²⁾ (60% of front facade w/in max.)	15 feet as measured from building front to right-of-way ⁽²⁾ (60% of front facade w/in max.)	15 feet as measured from building front to right-of-way ⁽²⁾ (60% of front facade w/in max.)
Side yard	no req.	no req.	no req.	no req.	no req.	no req.
Rear yard	no req.	no req.	no req.	no req.	no req.	no req.
Driveway length (minimum)	25 feet for residential units	25 feet for residential units	25 feet for residential units	25 feet for residential units	25 feet for residential units	25 feet for residential units
Building height (min. - max.)	2 - 4 stories.	2 - 4 stories.	2 - 4 stories.	2 - 4 stories.	2 - 4 stories.	2 - 4 stories.
Planter Style	N/A	Planter Bed	Boulevard Sod	Boulevard Sod	N/A	Boulevard Sod
Tree Spacing (on center)	N/A	35 feet	35 feet	35 feet	35 feet	35 feet
Boulevard Width	N/A	6 feet	6 feet	6 feet	N/A	6 feet
Sidewalk Width	10 feet	10 feet	6 feet	10 feet	10 feet	10 feet

1. Residential density is based on the net area of the parcel in question for parcels. In the event that public open space that is not dedicated to the City is developed independently of any particular residential project, the land area of the open space shall be divided equally among those abutting projects for purposes of density calculations.
2. Build to line shall be measured from building front to edge of right-of-way, or edge of sidewalk easement as defined by the City and said sidewalk must be encumbered by a sidewalk easement recorded with the office of the Anoka County Recorder.
3. The City may approve up to a 60-foot setback if it finds that topography or other factors require that a building be set back further to achieve acceptable grades or buffer between the street, the site entrance and the building.
4. In order to address vision clearance standards on higher speed roadways, parcels that are located at an intersection with an arterial roadway are allowed a build-to line of 35 feet from both streets.

A. At least sixty (60%) percent of street frontage of any lot shall be occupied by building facades meeting this build-to-line. On lots with more than one (1) street frontage, the build to line shall apply on each side fronting a street. An enclosed open area plaza space or outdoor seating with a decorative wall with a minimum height of three feet (3') and a maximum of four and one-half feet (4 ½') can be used to meet the sixty (60%) percent street frontage requirement.

B. Screening Of Parking Areas: Wherever a surface parking area faces a street frontage, such frontage shall be screened with a decorative wall, railing, hedge, or a combination of these elements, to a minimum height of three feet (3') and a maximum height of four and one-half feet (4 ½') above the level of the parking lot, at the build-to line. This screening may be broken into sections along the street edge provided it meets the sixty (60%) percent required.

Sub-District Framework - COR4 Neighborhood

Public Realm/Streetscape

Two prominent public parks supply much of the informal green space for The COR, and more specifically, provide the valuable park frontage and mix of amenities needed to support housing development within the Neighborhood Sub-district. North Commons surrounds an existing wetland and provides open space for year-round activities including a proposed sledding hill. The sub-district is adjacent to The Draw, which is characterized by wetlands, ponds and a meandering stream channel surrounded by gently sloping hills. Other park features include active and passive recreation areas, natural and manicured landscapes, education and interpretation opportunities, pedestrian and bicycle trails and many other amenities. Tree-lined streets connect these parks to surrounding residential neighborhoods and to nearby parks and amenities throughout The COR.

Site Development

The Neighborhood Sub-district emphasizes residential development. To support the proposed mix of housing, a framework of streets and blocks, based on the traditional grid system, encourages compact development patterns with increasing densities closer to the heart of The COR. Typical blocks either front onto signature parks or include some private green space within the site; many blocks have both. The arterial streets that frame this property, including Ramsey, Armstrong and Bunker Lake Boulevards, provide an important 'face' for this sub-district. Residential front doors will connect with public walks along each of these streets promoting the urban character of The COR.

Architecture

The largest in terms of overall acreage, the Neighborhood Sub-district will define the character and quality of the entire northern half of The COR property. With prominent street frontage along most of the major thoroughfares that serve this site, the variety of choices for building type, architectural style and design detailing are crucial decisions that together will promote a safe and attractive residential neighborhood. Integrating contemporary and traditional styles is also an important consideration, central to the notion that a unique and creative model for housing development will be a signature for The COR. Architecture to be '4-sided' at all locations visible to public areas. Emphasis will be on great design along public street frontage.

Table 6

COR4 Development Standards						
	Arterial Street	Destination Street	Parkway	Connector Street	Downtown Street	Local Street
Minimum lot size	None	None	None	None	None	None
Minimum lot width	20 feet	20 feet	20 feet	20 feet	20 feet	20 feet
Minimum lot depth	80 feet	80 feet	80 feet	80 feet	80 feet	80 feet
Allowable residential density in dwelling units per acre ⁽¹⁾	4-15 DU/AC	4-15 DU/AC	4-15 DU/AC	4-15 DU/AC	4-15 DU/AC	4-15 DU/AC
Minimum floor area ratio (FAR) for nonresidential uses/vertically mixed buildings/sites	.25	.25	.25	.25	.25	.25
Build to Line						
Front yard ⁽⁴⁾	30 feet as measured from building front to right-of-way ⁽²⁾⁽³⁾ (60% of front facade w/in max.)	20 feet as measured from building front to right-of-way ⁽²⁾ (60% of front facade w/in max.)	20 feet as measured from building front to right-of-way ⁽²⁾ (60% of front facade w/in max.)	20 feet as measured from building front to right-of-way ⁽²⁾ (60% of front facade w/in max.)	20 feet as measured from building front to right-of-way ⁽²⁾ (60% of front facade w/in max.)	20 feet as measured from building front to right-of-way ⁽²⁾ (60% of front facade w/in max.)
Side yard	no req.	no req.	no req.	no req.	no req.	no req.
Rear yard	no req.	no req.	no req.	no req.	no req.	no req.
Driveway length (minimum)	25 feet for residential units	25 feet for residential units	25 feet for residential units	25 feet for residential units	25 feet for residential units	25 feet for residential units
Building height (min. - max.)	1-4 stories.	1-4 stories.	1-4 stories.	1-4 stories.	1-4 stories.	1-4 stories.
Planter Style	N/A	Planter Bed	Boulevard Sod	Boulevard Sod	N/A	Boulevard Sod
Tree Spacing (on center)	N/A	35 feet	35 feet	35 feet	35 feet	35 feet
Boulevard Width	N/A	6 feet	6 feet	6 feet	N/A	6 feet
Sidewalk Width	10 feet	10 feet	6 feet	10 feet	10 feet	10 feet

1. Residential density is based on the net area of the parcel in question for parcels. In the event that public open space that is not dedicated to the City is developed independently of any particular residential project, the land area of the open space shall be divided equally among those abutting projects for purposes of density calculations.
2. Build to line shall be measured from building front to edge of right-of-way, or edge of sidewalk easement as defined by the City and said sidewalk must be encumbered by a sidewalk easement recorded with the office of the Anoka County Recorder.
3. The City may approve up to a 60-foot setback if it finds that topography or other factors require that a building be set back further to achieve acceptable grades or buffer between the street, the site entrance and the building.
4. In order to address vision clearance standards on higher speed roadways, parcels that are located at an intersection with an arterial roadway are allowed a build-to line of 35 feet from both streets.

A. Screening Of Parking Areas: Wherever a surface parking area faces a street frontage, such frontage shall be screened with a decorative wall, railing, hedge, or a combination of these elements, to a minimum height of three feet (3') and a maximum height of four and one-half feet (4½') above the level of the parking lot, at the build-to line. This screening may be broken into sections along the street edge provided it meets the sixty (60%) percent required.

Sub-District Framework - COR5 Parks & Open Space

Public Realm/Streetscape

The overall structure of The COR is based on a system of linked parks, trails and open space. This includes existing and proposed parks and trails defined in city and regional parks plans, joined with new parks and trails within The COR. Of equal importance is the contribution from each block and each development project to this green structure, adding a variety of private, semi-private and perhaps some additional public space throughout each sub-district. Great strolling streets provide connections between commercial, workplace, entertainment and residential neighborhoods and encourage shared use for cars, pedestrians and bicycles.

Site Development

The COR Master Plan illustrates a strong framework of green space, including a mix of public parks, destination amenities, courtyards, commons and other features. As a key component of the overall plan, this integrated system of parks, trails and open space provides the framework around which all other land uses are organized. Placemaking and connectivity are important site development considerations, linking each block and each sub-district with major public spaces nearby and with many other amenities and attractions in The COR.

Architecture

There are numerous opportunities to include buildings and other structures as significant design features within the proposed parks, trails and open space system for The COR. These could range from simple picnic shelters and landscaped arbors to more complex park buildings that might contain meeting rooms, rest rooms, storage areas and other facilities. Design of these important buildings should respond to the specific setting and landscape features in each park, and complement the overall character and quality of buildings located within surrounding blocks. Additionally, limited retail is planned along the perimeter of the park.

Table 7

COR5 Development Standards						
	Arterial Street	Destination Street	Parkway	Connector Street	Downtown Street	Local Street
Minimum lot size	0.5	N/A	0.5	0.5	0.5	0.5
Minimum lot width	N/A	N/A	N/A	N/A	N/A	N/A
Minimum lot depth	N/A	N/A	N/A	N/A	N/A	N/A
Allowable residential density in dwelling units per acre ⁽¹⁾	N/A	N/A	N/A	N/A	N/A	N/A
Minimum floor area ratio (FAR) for nonresidential uses/vertically mixed buildings/sites	N/A	N/A	N/A	N/A	N/A	N/A
Build to Line						
Front yard ⁽⁴⁾	30 feet as measured from building front to right-of-way ⁽²⁾⁽³⁾ (60% of front facade w/in max.)	N/A	10 feet as measured from building front to right-of-way ⁽²⁾ (60% of front facade w/in max.)	10 feet as measured from building front to right-of-way ⁽²⁾ (60% of front facade w/in max.)	10 feet as measured from building front to right-of-way ⁽²⁾ (60% of front facade w/in max.)	10 feet as measured from building front to right-of-way ⁽²⁾ (60% of front facade w/in max.)
Side yard	no req.	N/A	no req.	no req.	no req.	no req.
Rear yard	no req.	N/A	no req.	no req.	no req.	no req.
Driveway length (minimum)	25 feet	N/A	25 feet	25 feet	25 feet	25 feet
Building height (min. - max.)	1-2 stories.	N/A	1-2 stories.	1-2 stories.	1-2 stories.	1-2 stories.
Planter Style	N/A	N/A	Boulevard Sod	Boulevard Sod	N/A	Boulevard Sod
Tree Spacing (on center)	N/A	N/A	35 feet	35 feet	35 feet	35 feet
Boulevard Width	N/A	N/A	6 feet	6 feet	N/A	6 feet
Sidewalk Width	10 feet	N/A	6 feet	10 feet	10 feet	10 feet

1. Residential density is based on the net area of the parcel in question for parcels. In the event that public open space that is not dedicated to the City is developed independently of any particular residential project, the land area of the open space shall be divided equally among those abutting projects for purposes of density calculations.
2. Build to line shall be measured from building front to edge of right-of-way, or edge of sidewalk easement as defined by the City and said sidewalk must be encumbered by a sidewalk easement recorded with the office of the Anoka County Recorder.
3. The City may approve up to a 60-foot setback if it finds that topography or other factors require that a building be set back further to achieve acceptable grades or buffer between the street, the site entrance and the building.
4. In order to address vision clearance standards on higher speed roadways, parcels that are located at an intersection with an arterial roadway are allowed a build-to line of 35 feet from both streets.

A. Where commercial buildings are planned, at least sixty (60%) percent of street frontage of any lot shall be occupied by building facades meeting this build-to-line. On lots with more than one (1) street frontage, the build to line shall apply on each side fronting a street. An enclosed open area plaza space or outdoor seating with a decorative wall with a minimum height of three feet (3') and a maximum of four and one-half feet (4 ½') can be used to meet the sixty (60%) percent street frontage requirement.

B. Screening Of Parking Areas: Wherever a surface parking area faces a street frontage, such frontage shall be screened with a decorative wall, railing, hedge, or a combination of these elements, to a minimum height of three feet (3') and a maximum height of four and one-half feet (4 ½') above the level of the parking lot, at the build-to line. This screening may be broken into sections along the street edge provided it meets the sixty (60%) percent required.

This page intentionally left blank.

Implementation

Introduction

This framework provides distinct strategies for guiding The COR's form and appearance. This framework's vision for the COR will take several years to implement. Successful implementation will require consistent application of the Design Framework by City staff. Zoning enforcement and design framework standards will not succeed without the cooperation and commitment of landowners, development interests, and the rest of the community.

Design Review

The Design Framework will be administered by staff as part of the development review process. Staff will incorporate design review to ensure compliance with the Design Framework as a standard step in the development review process.

This page intentionally left blank

APPENDIX A: SPECIFICATIONS AND DETAILS

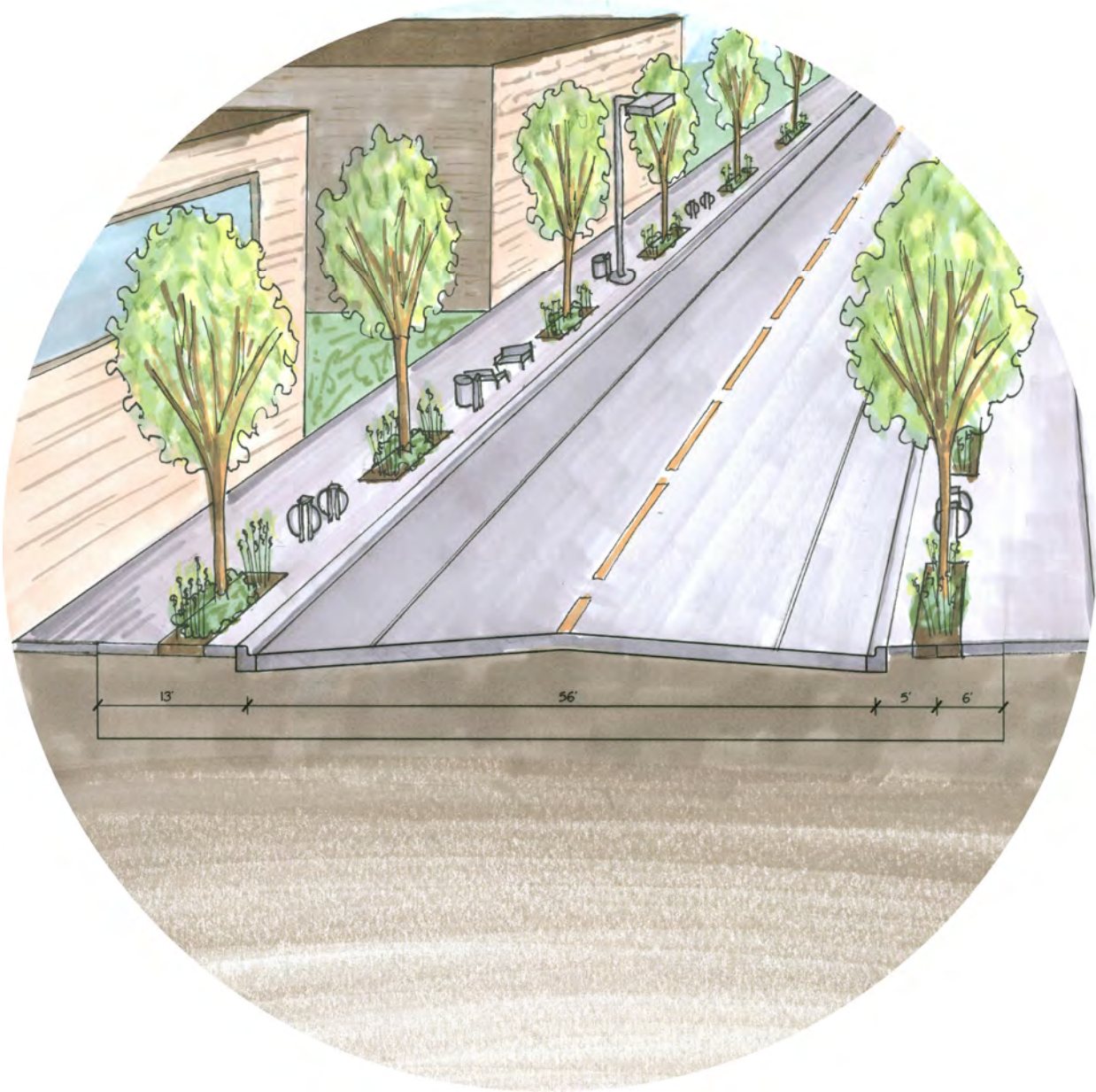
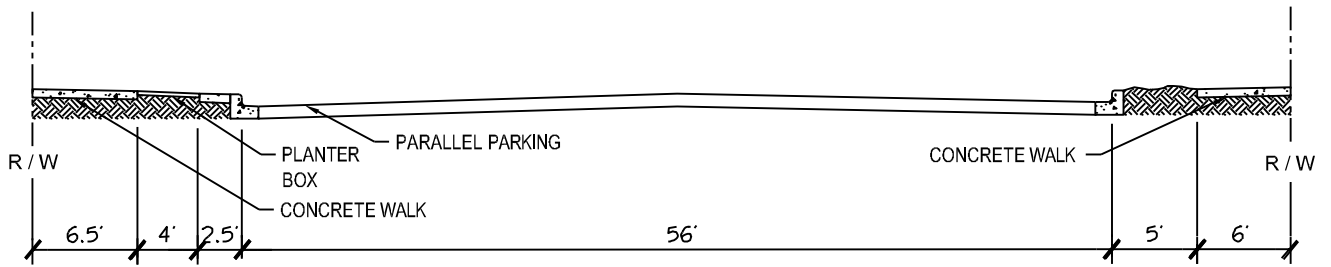

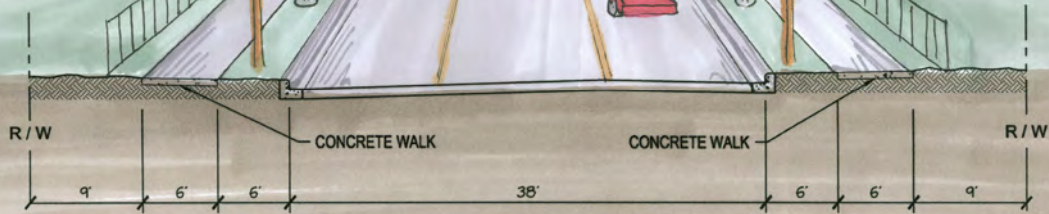
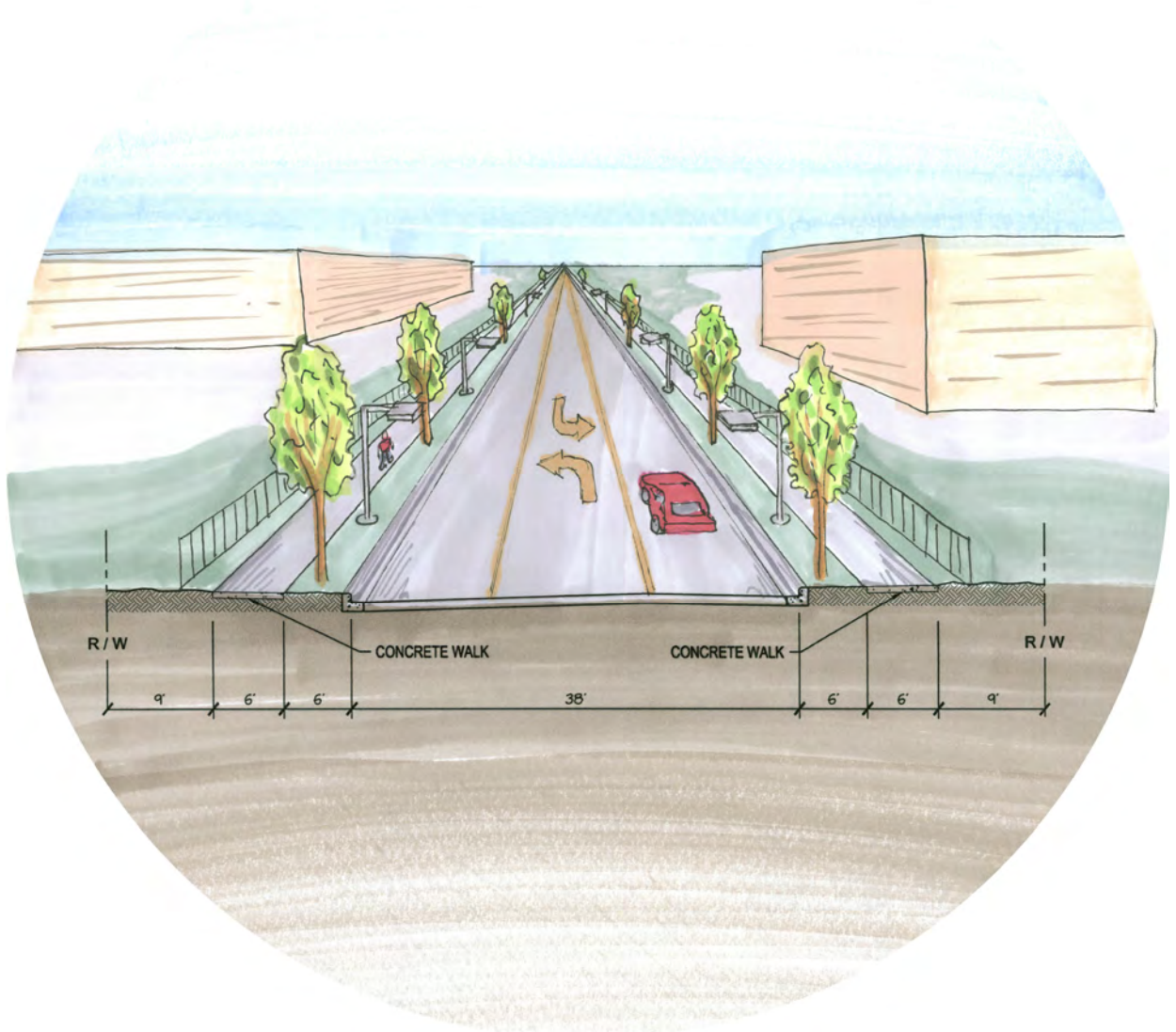
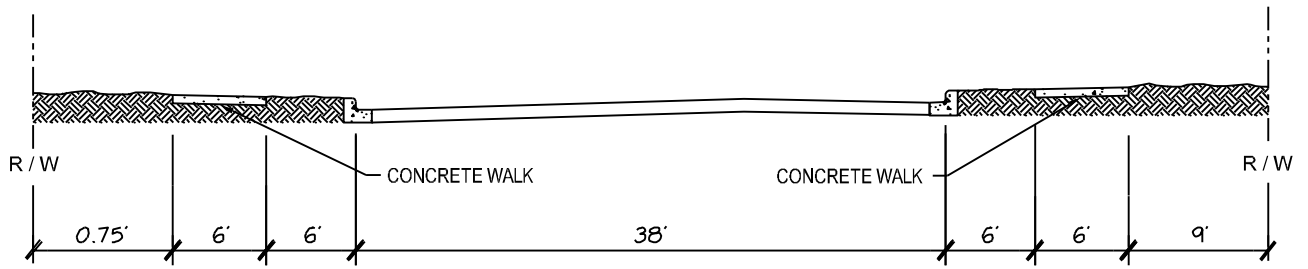

LANDFORM
From Site to Finish

DESIGN FRAMEWORK
The COR at Ramsey
PERSPECTIVE SECTION #2
Sunwood Dr. West of Zeolite St.

THE
COR
RAMSEY, MINNESOTA

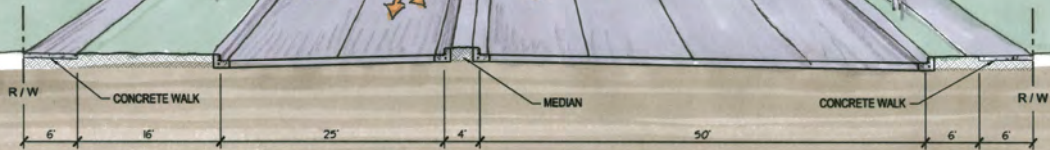
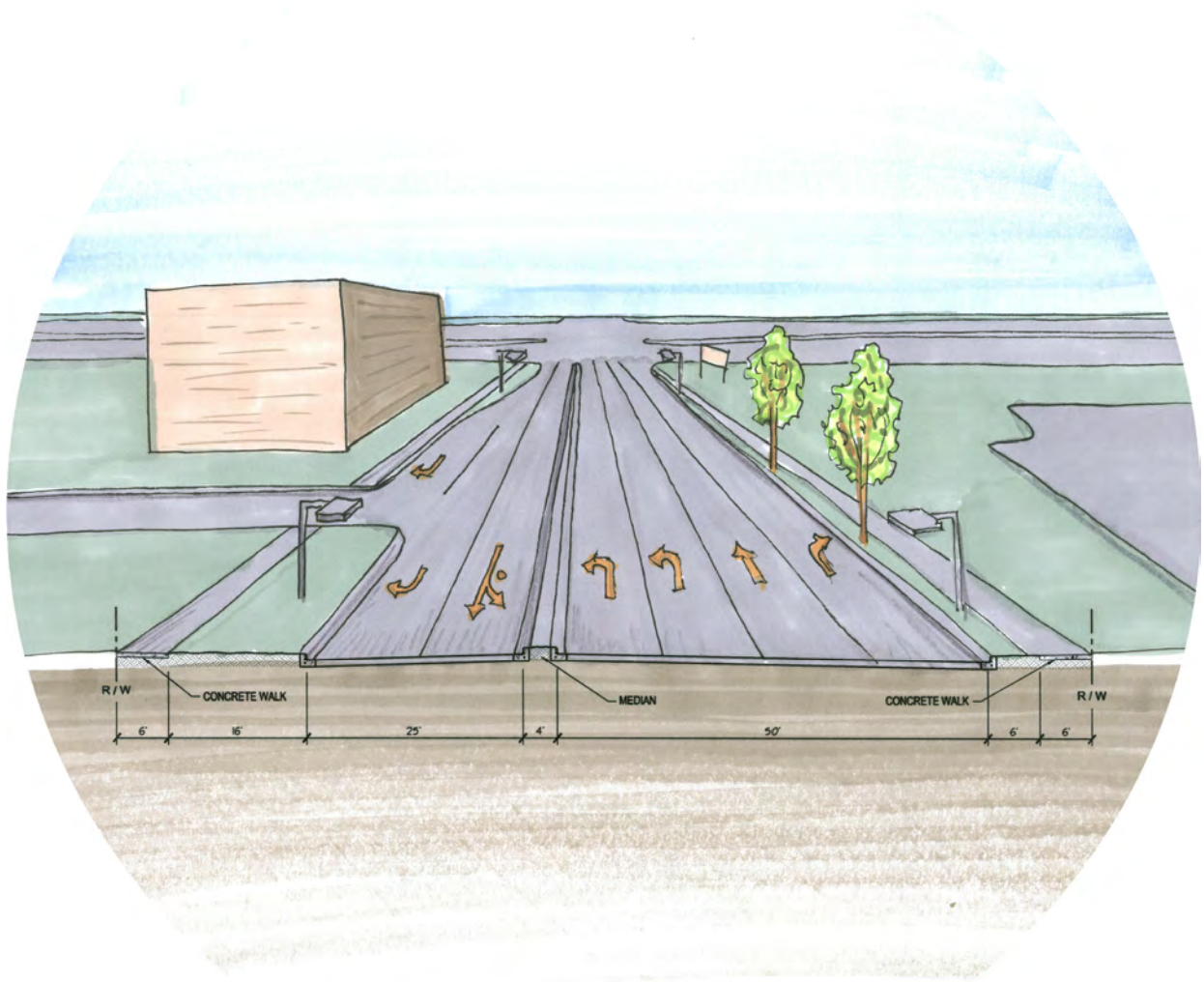
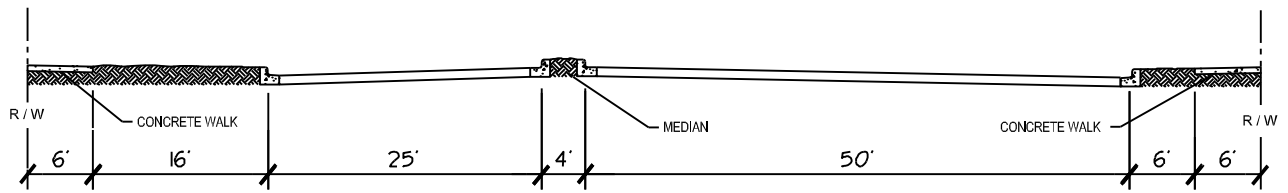

LANDFORM
From Site to Finish

DESIGN FRAMEWORK
The COR at Ramsey
PERSPECTIVE SECTION #3
Ramsey Pkwy. West of Roundabout

THE
COR
RAMSEY, MINNESOTA

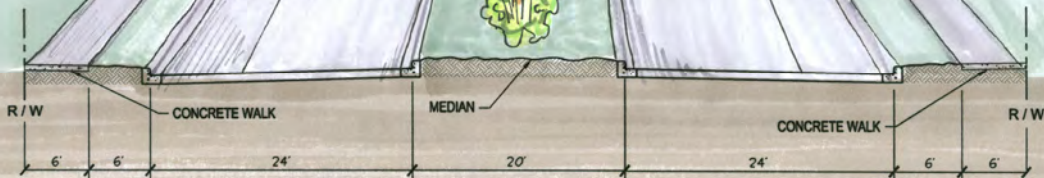
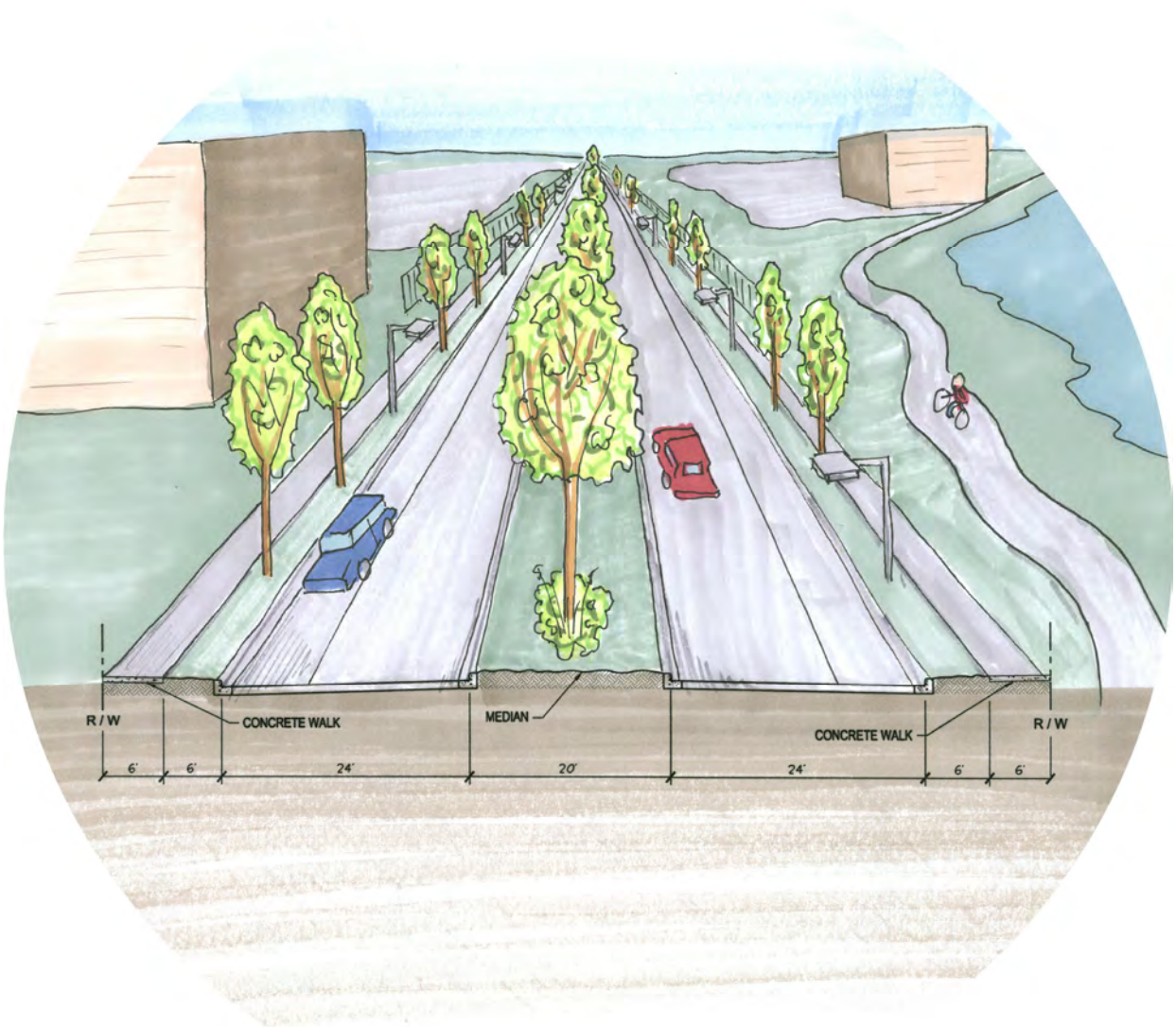
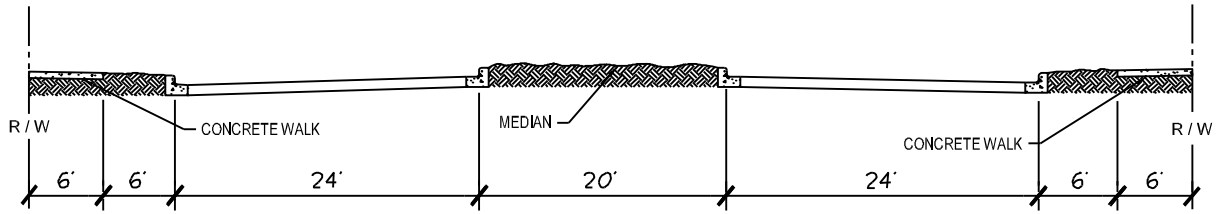

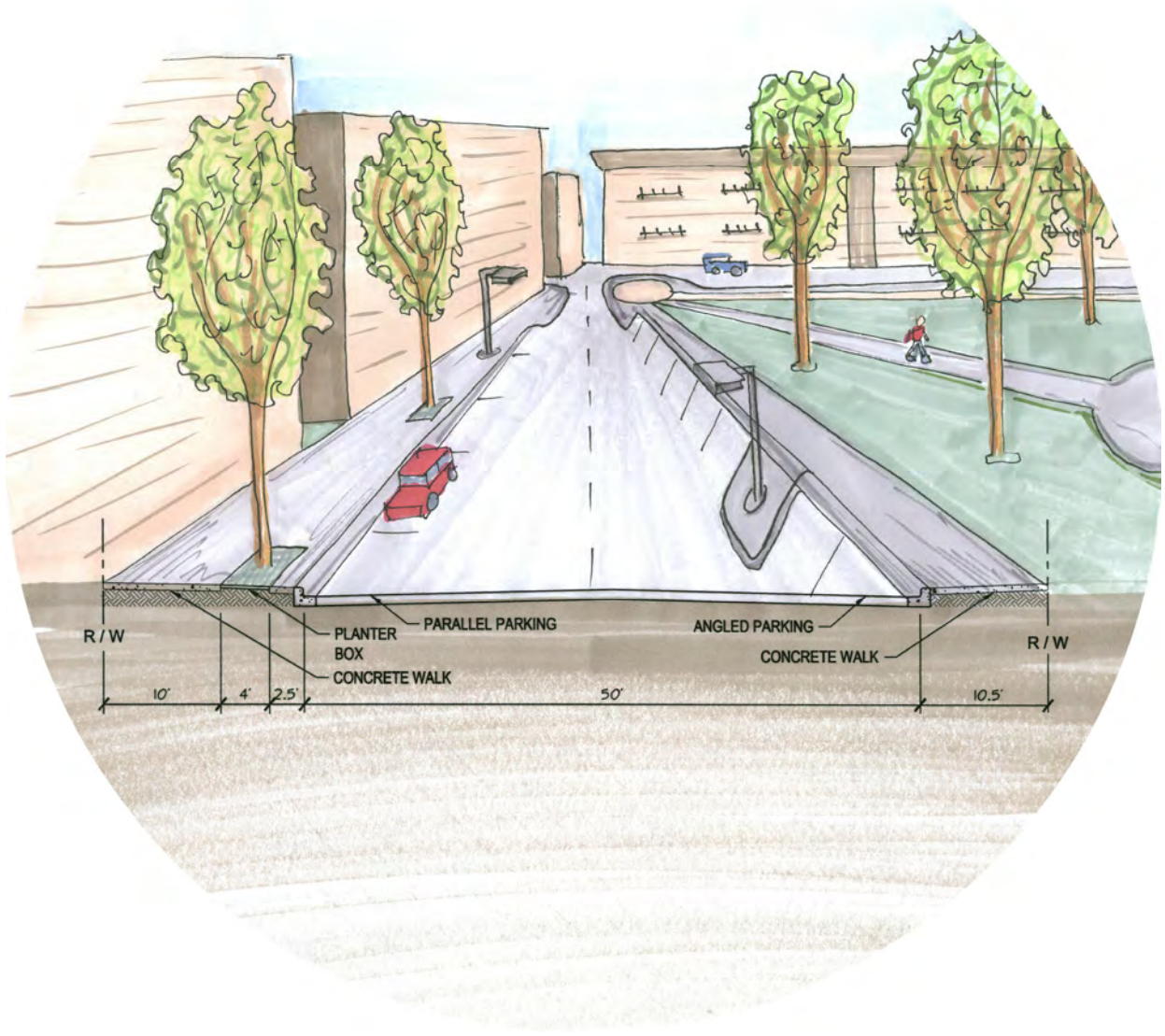
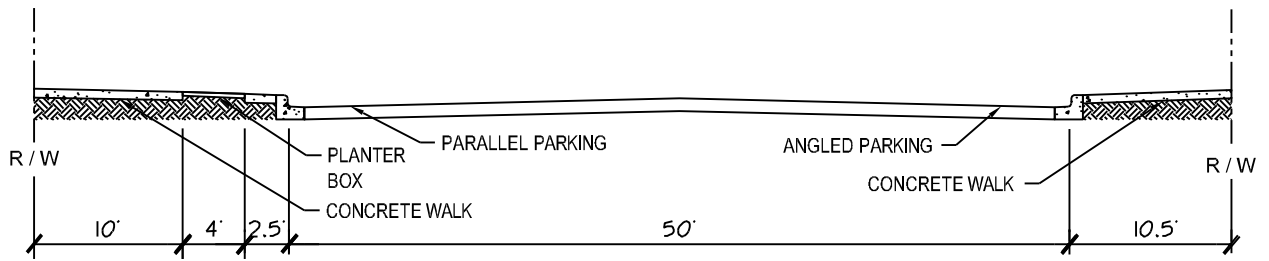

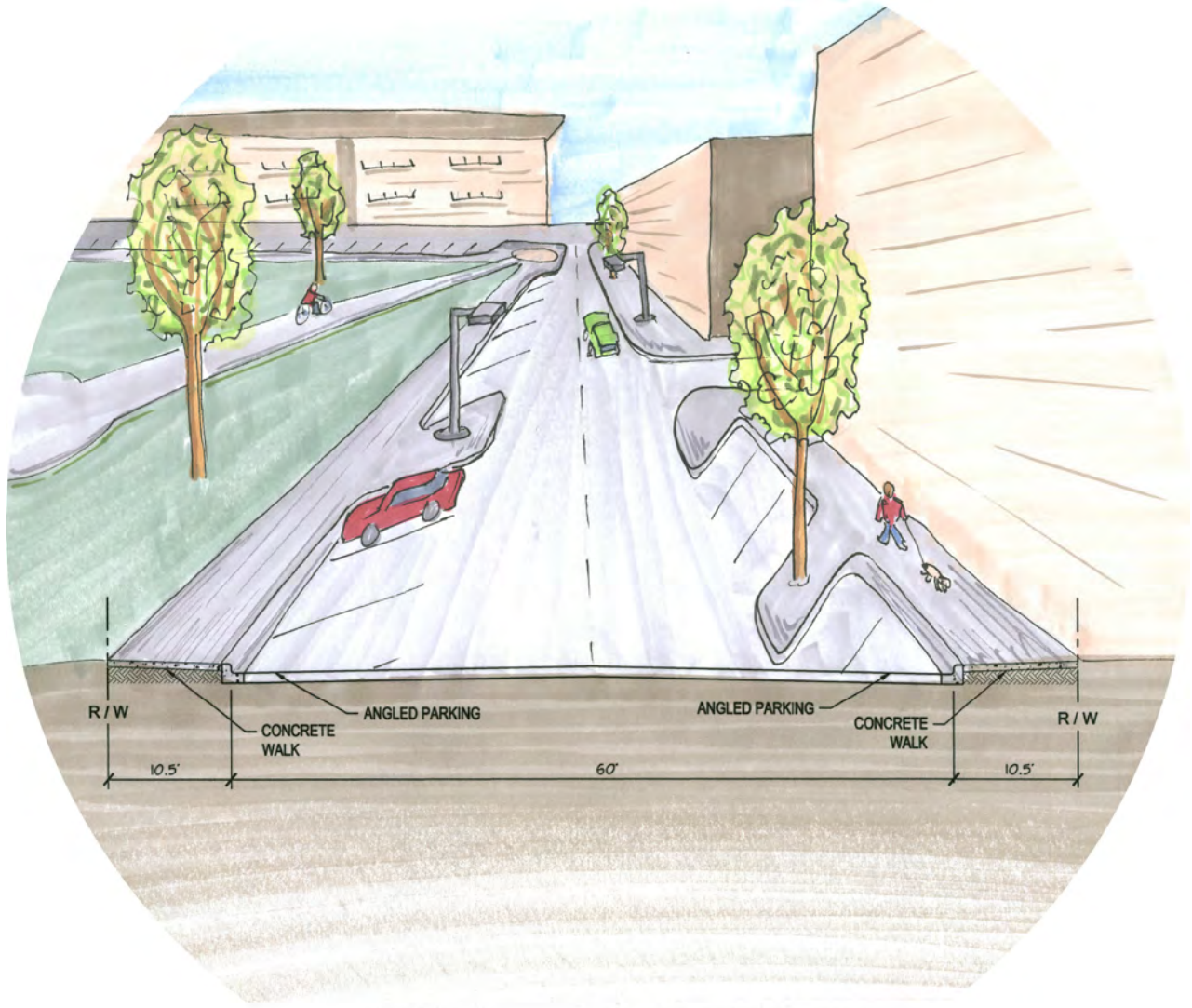
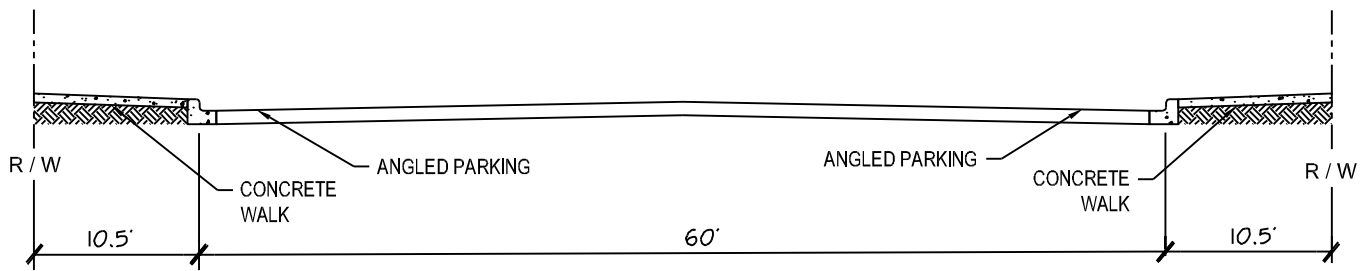

• •
L A N D F O R M
 From Site to Finish

DESIGN FRAMEWORK
 The COR at Ramsey
 PERSPECTIVE SECTION #6
 Center St. East of Municipal Plaza



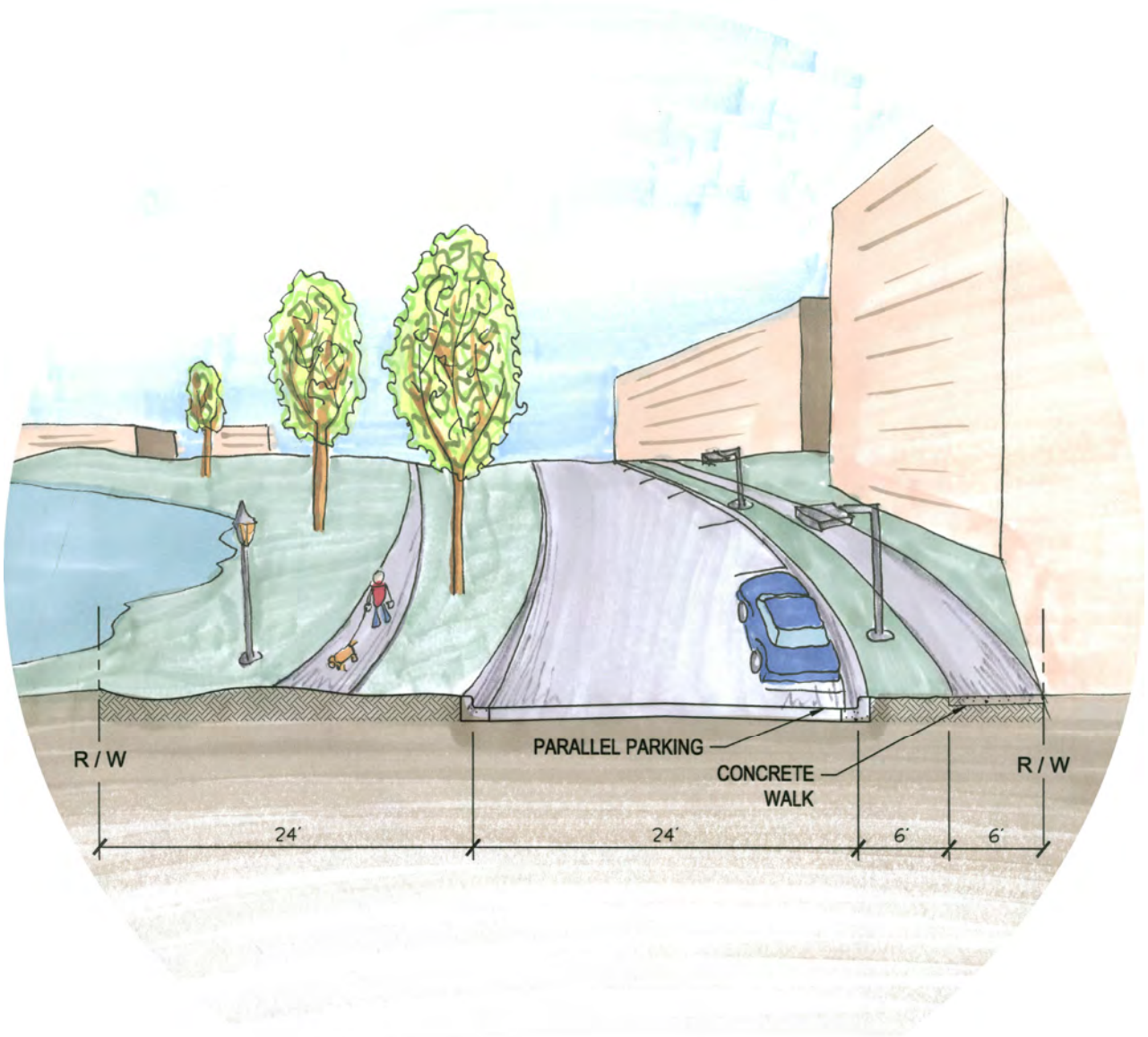
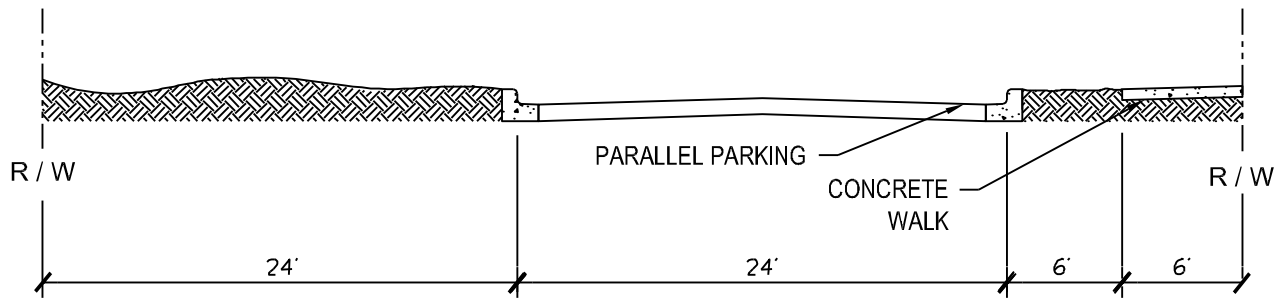

● ●
L A N D F O R M
 From Site to Finish

DESIGN FRAMEWORK
 The COR at Ramsey
 PERSPECTIVE SECTION #7
 Ramsey Pkwy. South of The Draw

THE
COR
 RAMSEY, MINNESOTA

THE COR

AT RAMSEY

- PYLON/COMMUNITY SIGNS
- COMMUNITY KIOSK
- PROJECT GATEWAY
- P PARKING

*See 'Appendix B' for sign details



Landform™ and Site to Finish™ are service marks of Landform Professional Services, LLC.

Signage Plan

09/06/2012





EXHIBIT B.1

	<p>DESIGN FRAMEWORK The COR at Ramsey</p> <hr/> <p>PYLON/COMMUNITY SIGN 'A' Armstrong Blvd. & Highway 10</p>	
--	--	--



Eastbound



Westbound

EXHIBIT B.2



DESIGN FRAMEWORK
The COR at Ramsey

PYLON/COMMUNITY SIGN 'B'
Commuter Rail & Highway 10





EXHIBIT B.3

	<p>DESIGN FRAMEWORK The COR at Ramsey</p> <hr/> <p>PYLON/COMMUNITY SIGN 'C' Ramsey Blvd. & Highway 10</p>	
--	---	--

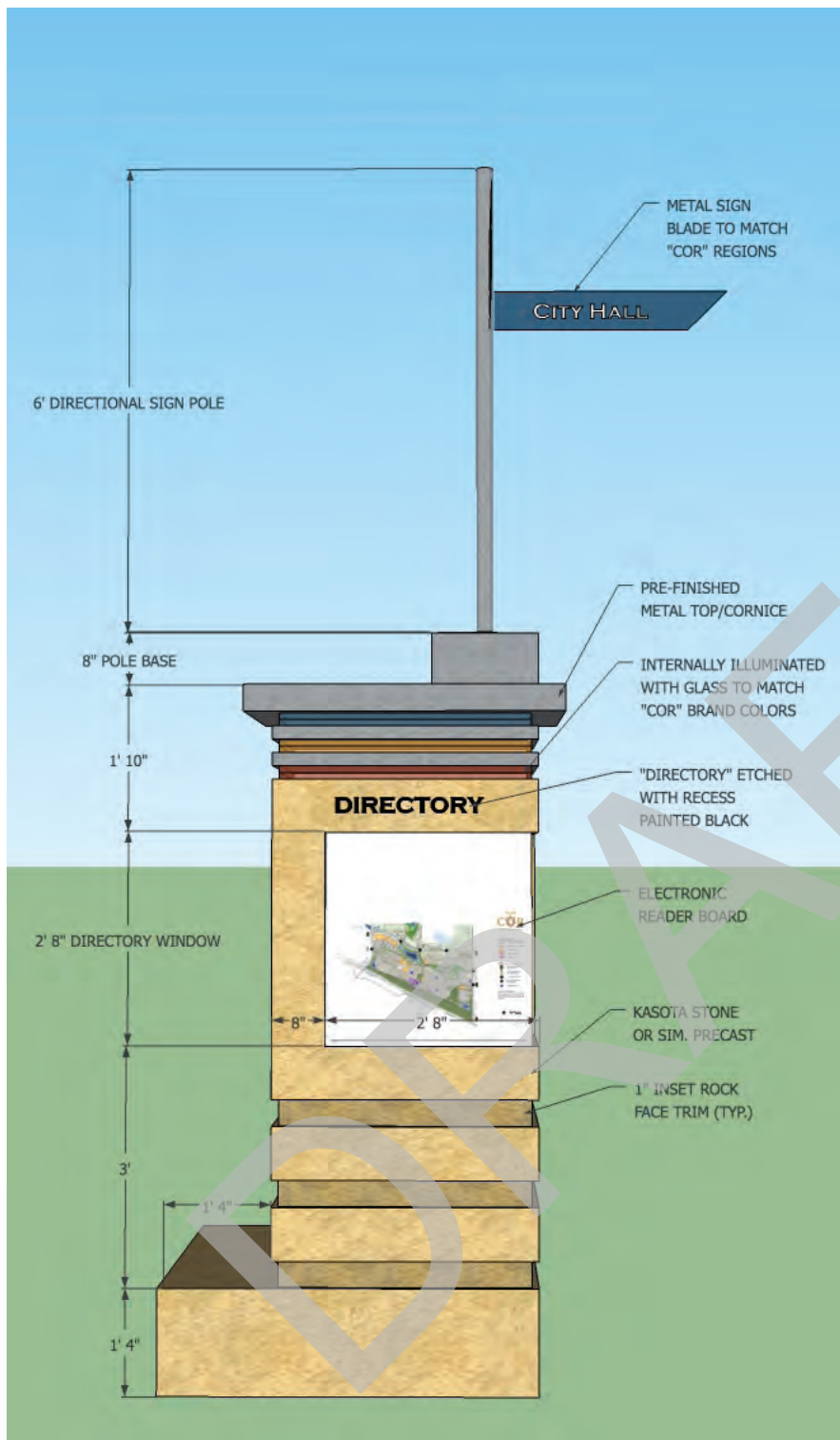

DIRECTORY PANEL VIEW



EVENTS PANEL VIEW

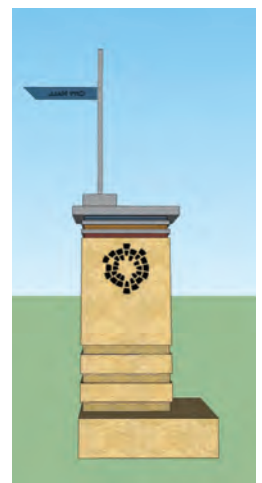

REAR VIEW

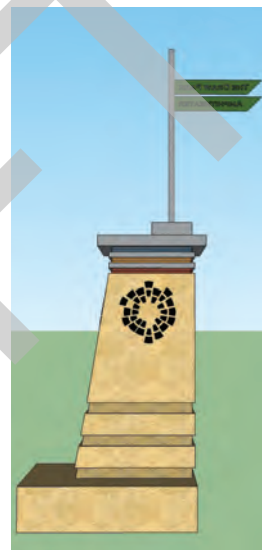

SIDE VIEW



PERSPECTIVE

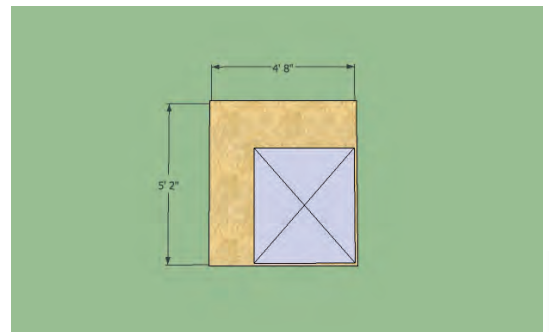

PLAN VIEW

EXHIBIT B.4



DESIGN FRAMEWORK
The COR at Ramsey

COMMUNITY KIOSK 'A'
Commuter Rail & Veterans Dr.



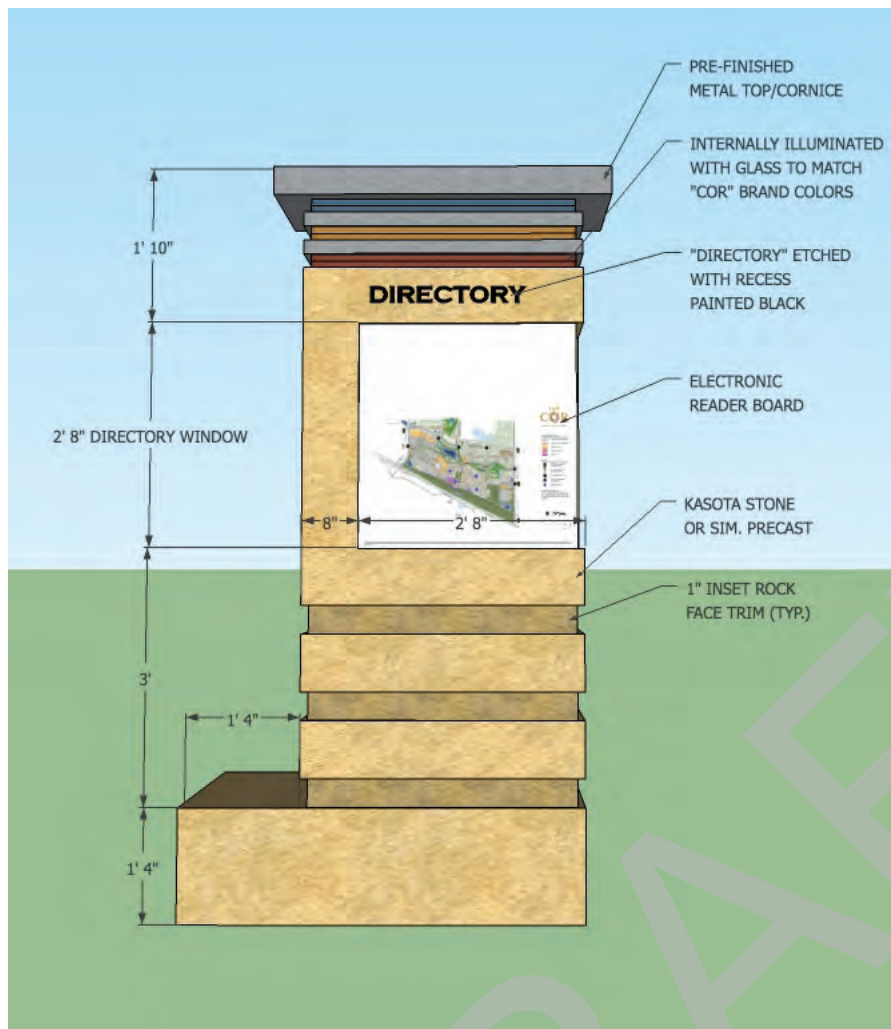

DIRECTORY PANEL VIEW



EVENTS PANEL VIEW

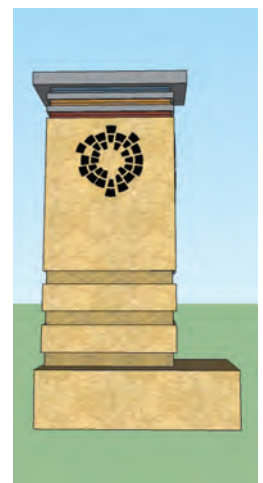

REAR VIEW



SIDE VIEW



PERSPECTIVE

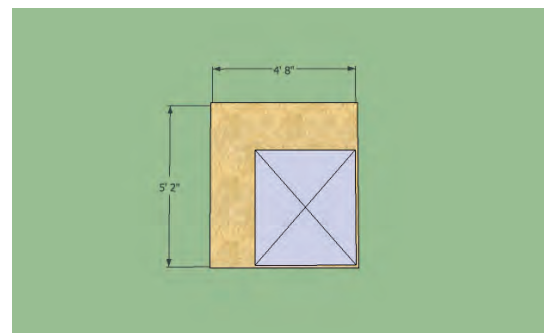

PLAN VIEW

EXHIBIT B.5



DESIGN FRAMEWORK
 The COR at Ramsey
 COMMUNITY KIOSK 'B'
 Sunwood Dr. & Center St.



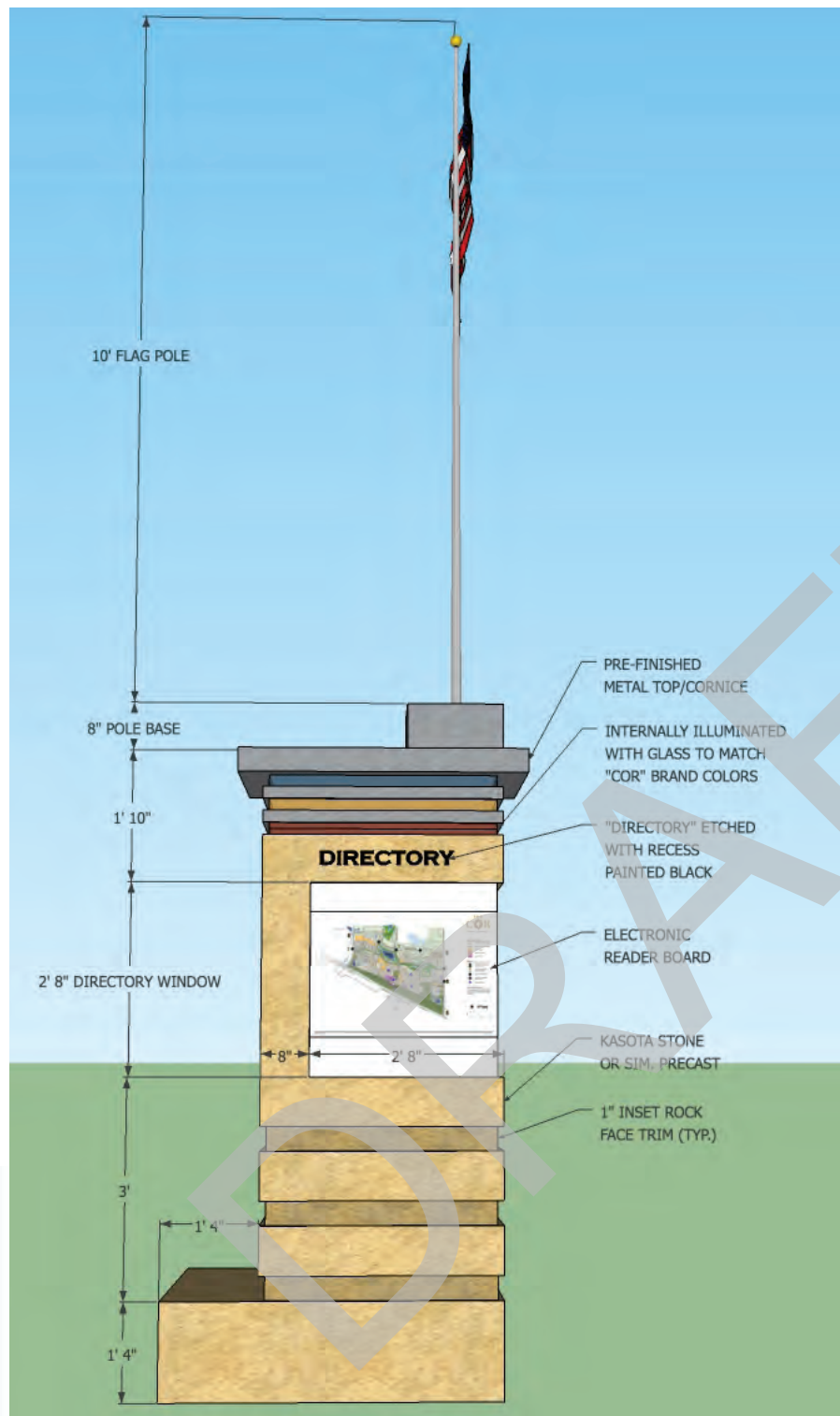

DIRECTORY PANEL VIEW



EVENTS PANEL VIEW

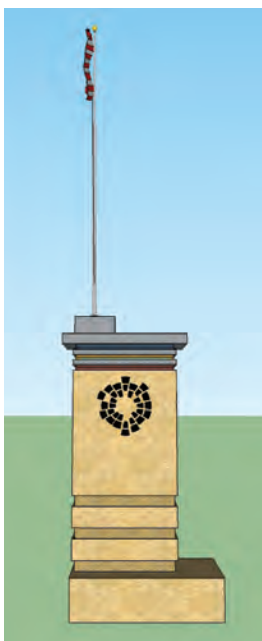

REAR VIEW

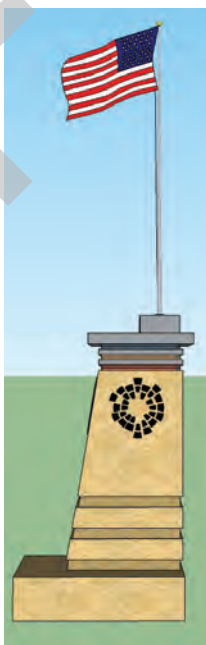

SIDE VIEW



PERSPECTIVE

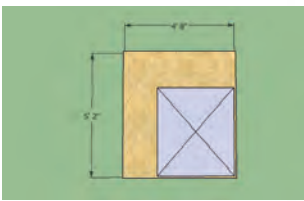

PLAN VIEW

EXHIBIT B.6

DESIGN FRAMEWORK
The COR at Ramsey
 COMMUNITY KIOSK 'C'
 Sunwood Dr. at Municipal Plaza

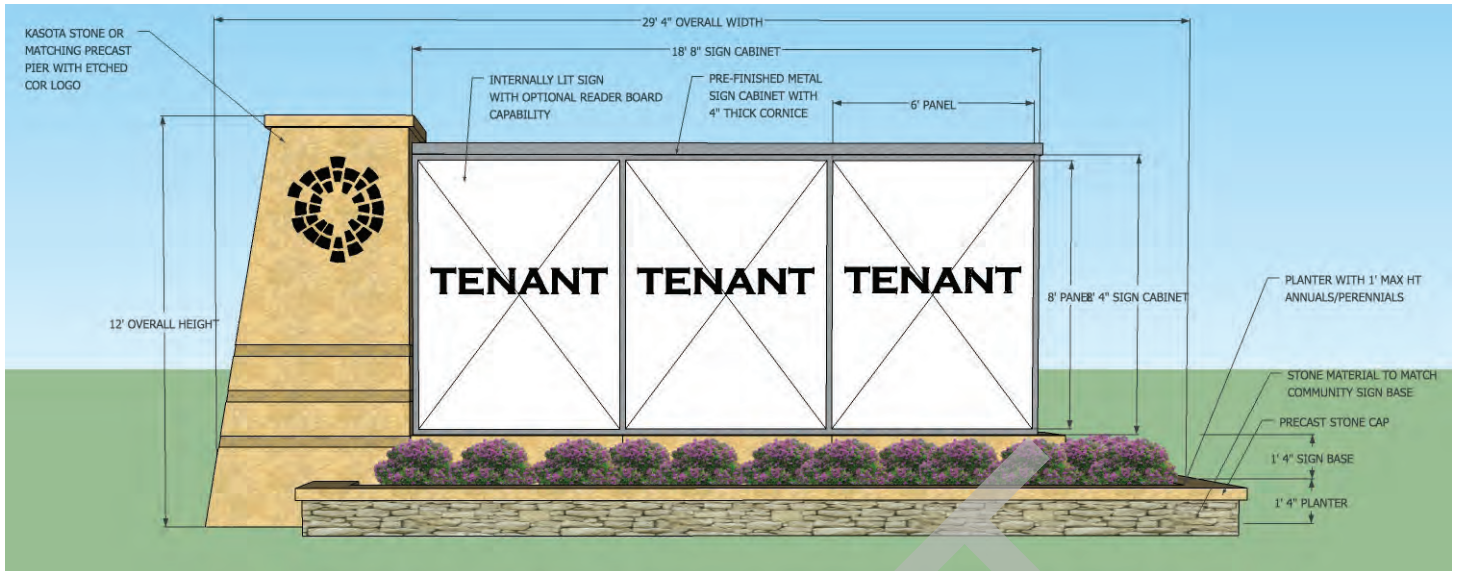

ELEVATION AT SUNWOOD

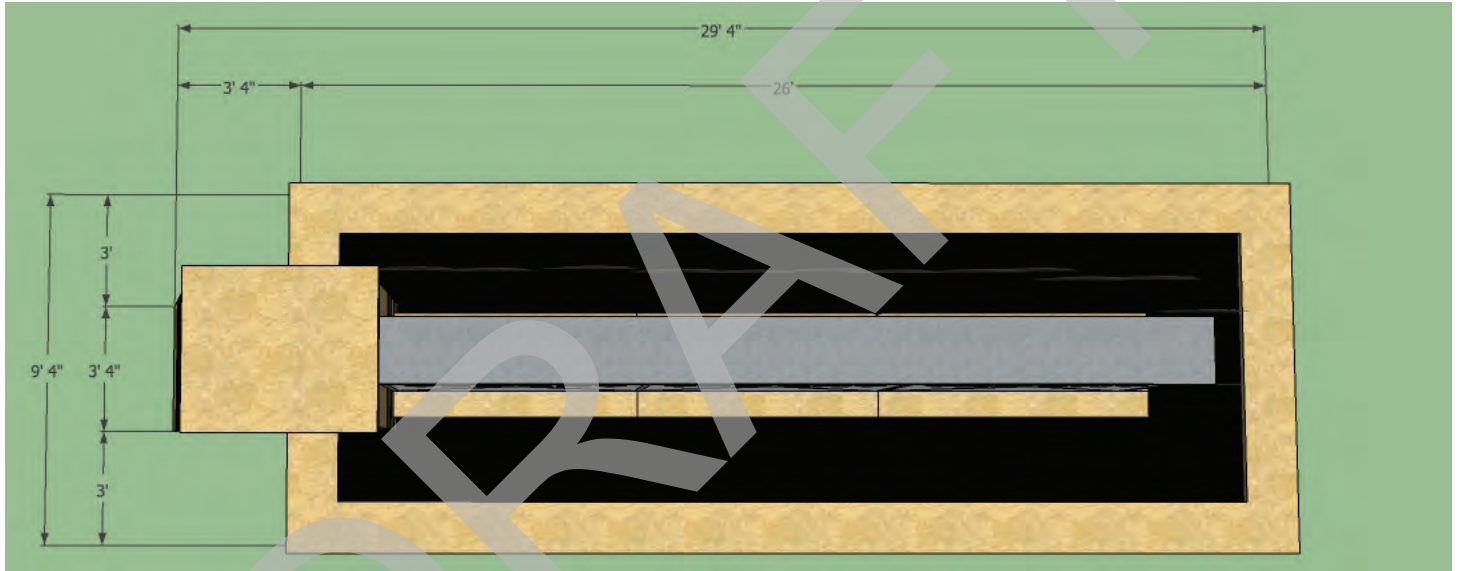

PLAN VIEW

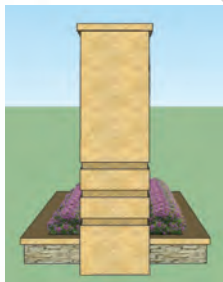

PROFILE VIEW



PROFILE VIEW

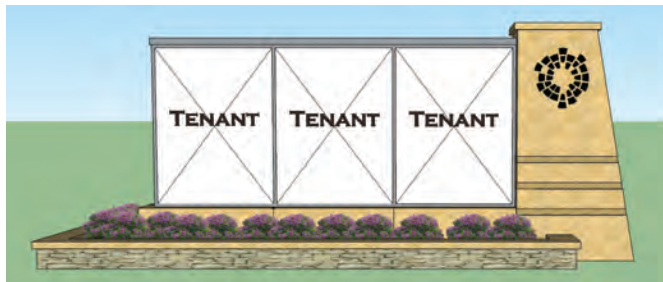

ELEVATION

EXHIBIT B.7



DESIGN FRAMEWORK
The COR at Ramsey
 PROJECT GATEWAY SIGN 'A'
 Sunwood Dr. & Armstrong Blvd.



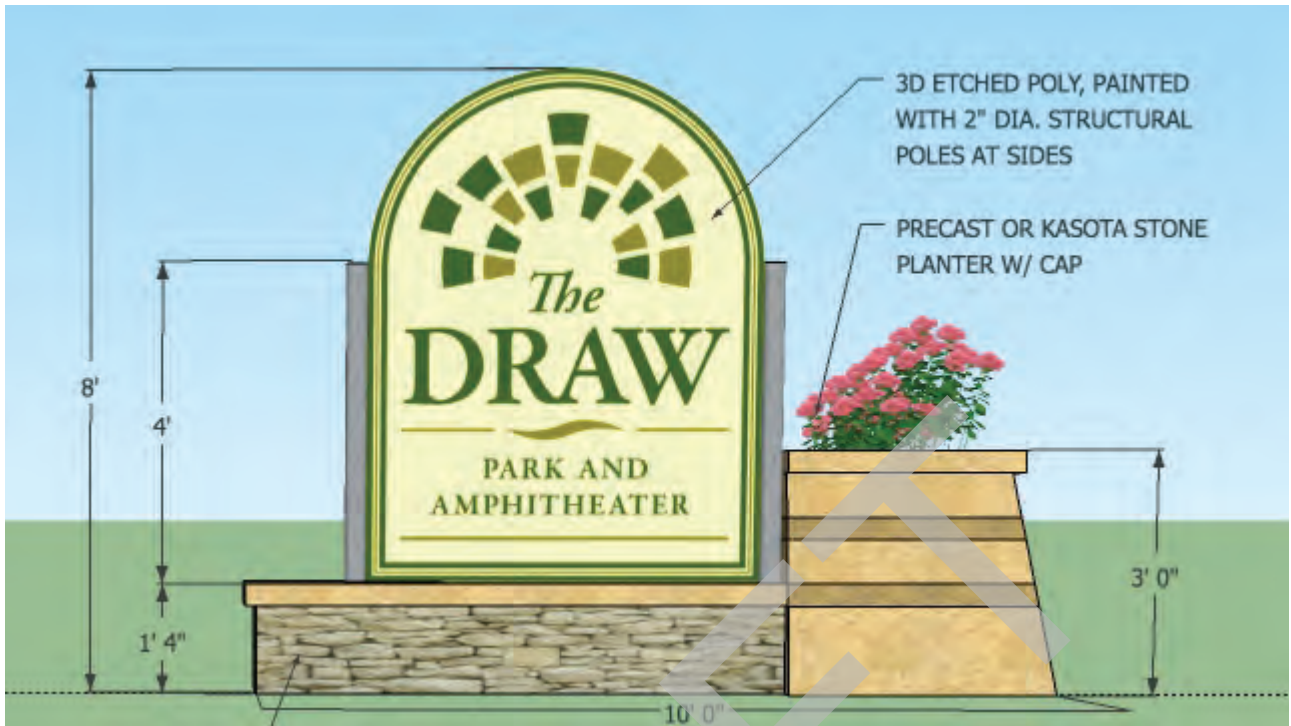
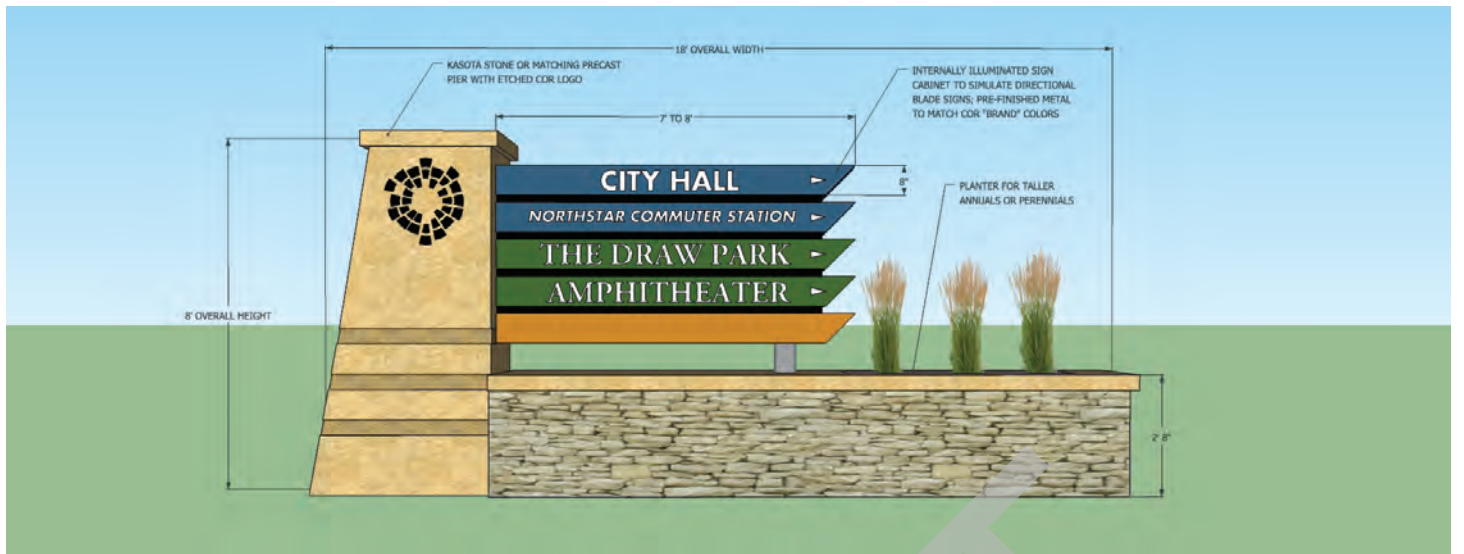
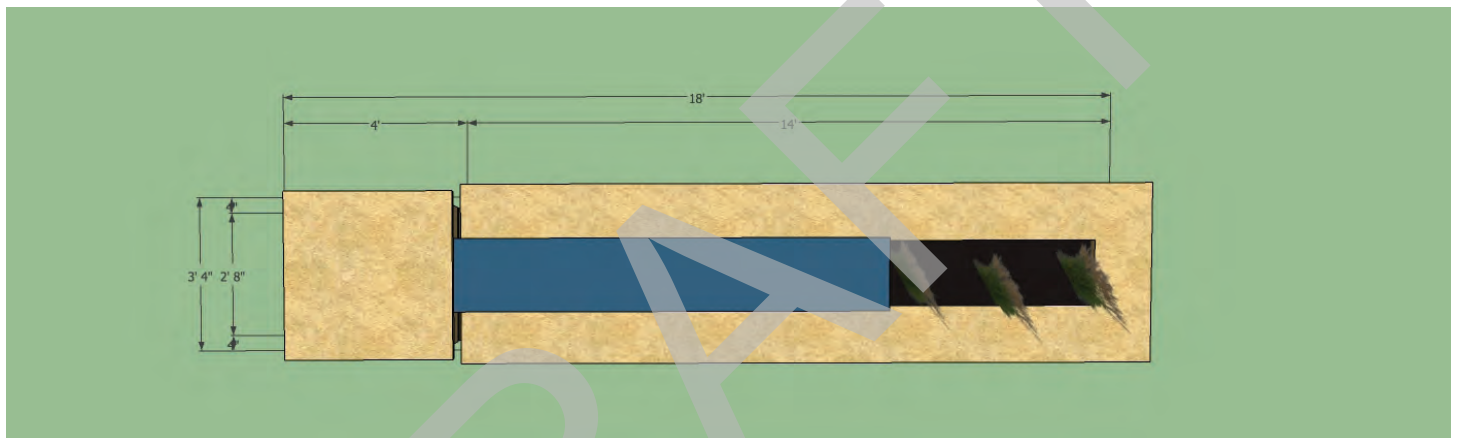

EXHIBIT B.8



ELEVATION AT EASTBOUND BUNKER LAKE



PLAN VIEW



PROFILE VIEW

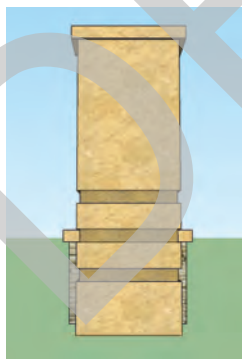

PROFILE VIEW



ELEVATION AT WESTBOUND BUNKER LAKE

EXHIBIT B.9



DESIGN FRAMEWORK
The COR at Ramsey
 PROJECT GATEWAY SIGN 'C'
 Bunker Lake Blvd. & Center St.





ELEVATION AT SOUTH BOUND RAMSEY

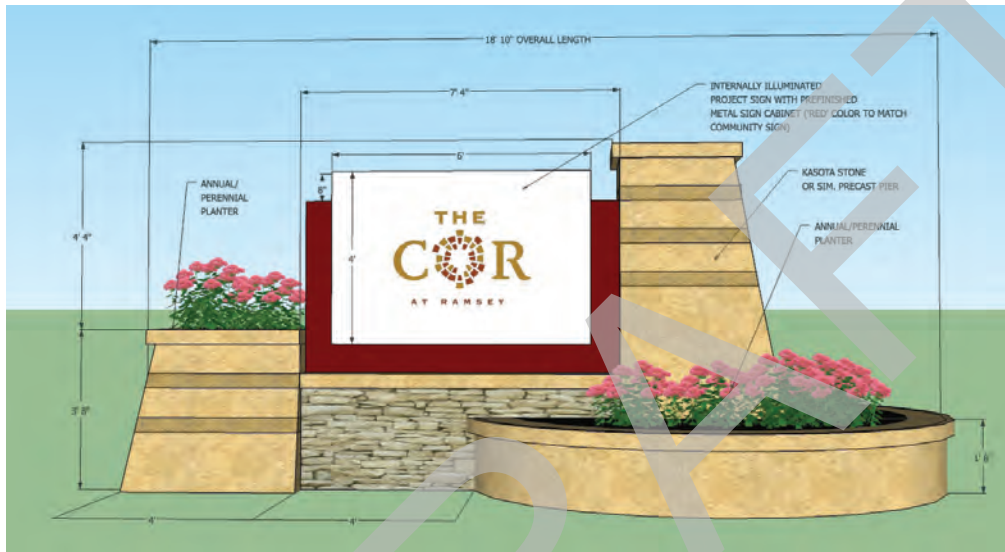

ELEVATION AT WESTBOUND BUNKER LAKE



PERSPECTIVE

EXHIBIT B.10



DESIGN FRAMEWORK
The COR at Ramsey

PROJECT GATEWAY SIGN 'D'
Bunker Lake Blvd. & Ramsey Blvd.



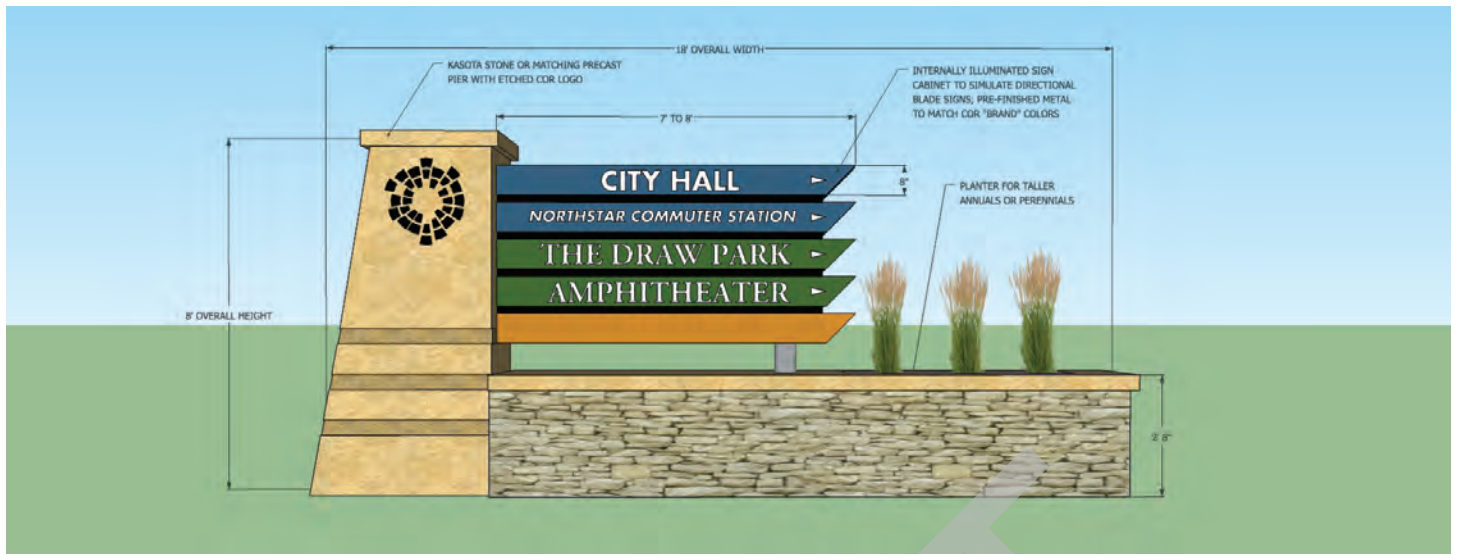

ELEVATION AT SOUTHBOUND RAMSEY

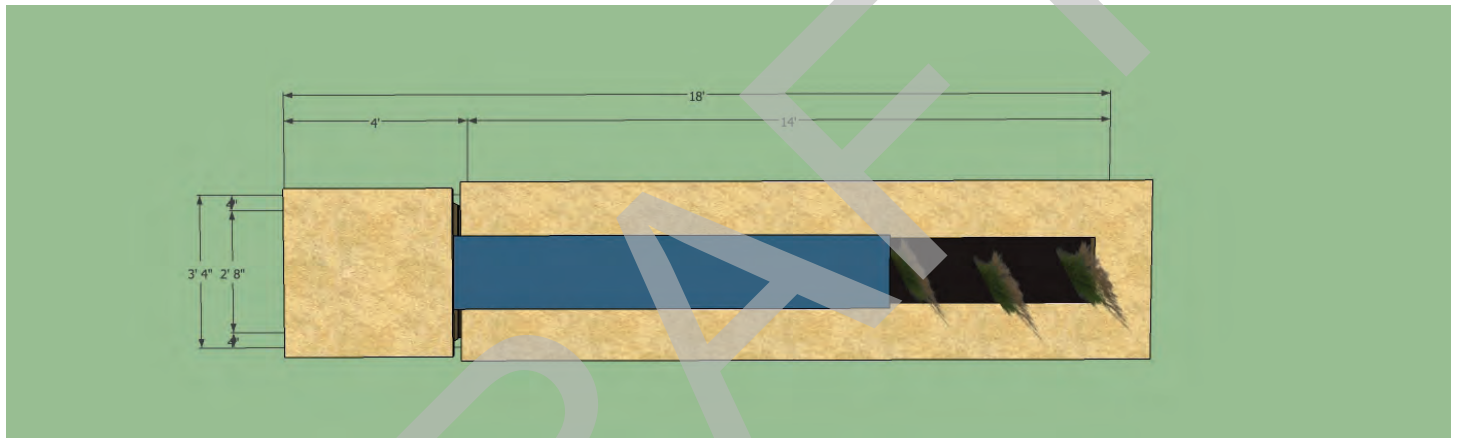

PLAN VIEW



PROFILE VIEW

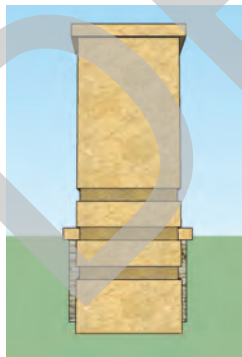

PROFILE VIEW



ELEVATION AT NORTHBOUND RAMSEY

EXHIBIT B.11



DESIGN FRAMEWORK
The COR at Ramsey
 PROJECT GATEWAY SIGN 'E'
 Sunwood Dr. & Ramsey Blvd.





EXHIBIT B.12

 From Site to Finish

DESIGN FRAMEWORK
 The COR at Ramsey

PUBLIC PARKING SIGNAGE
 Standard Signage





EXHIBIT B.13

L A N D F O R M
 From Site to Finish

DESIGN FRAMEWORK
The COR at Ramsey
 LIGHT POLE BANNER SIGNS
 Standard Signage





PERMANENT TENANT SIGN 1.



RAMP MARQUEE SIGN 2.



INFILL BANNERS 3.



COLUMN BANNERS 4.



WINDOW FILM SIGN 5.



PERMANENT TENANT SIGN 6.

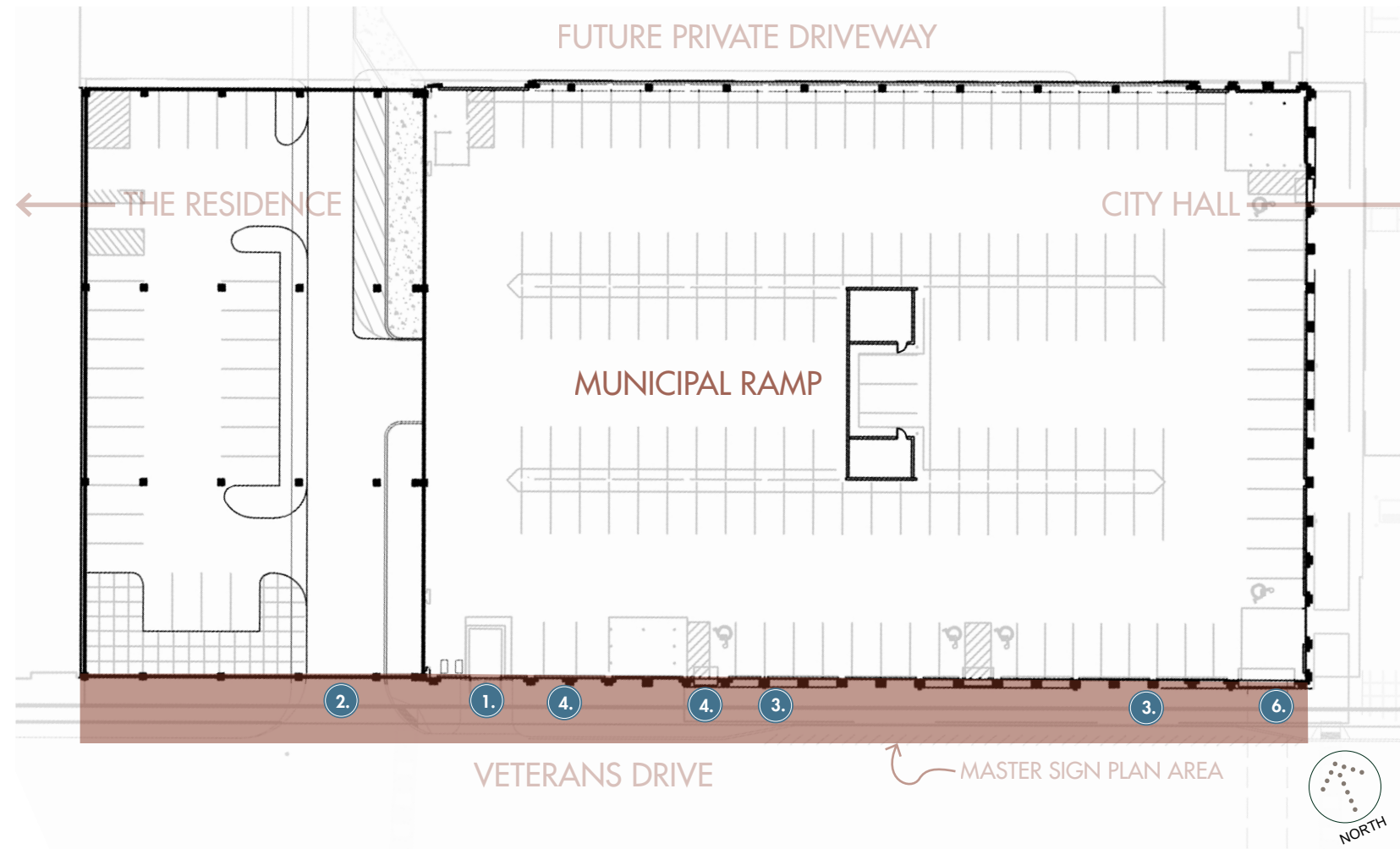

PLAN - N.T.S.

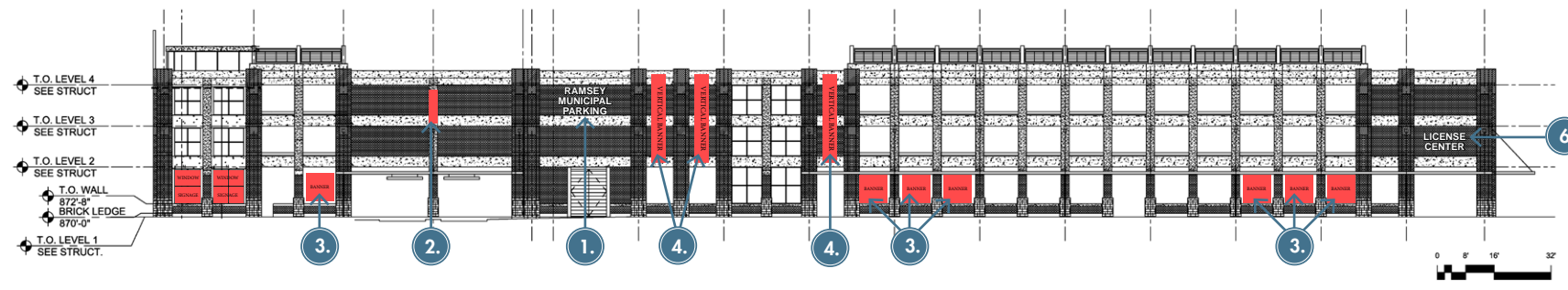

SOUTH ELEVATION - N.T.S.



Sign Descriptions:

- 1. 'RAMSEY MUNICIPAL PARKING' brushed aluminum letters, flood illuminated.
Typical Sign Area = ±66 S.F.
Qty. 1 Total South Elevation = 66 S.F.
- 2. Two-sided Internally illuminated marquee sign cabinet. Typical Sign Area = ±60 S.F.
Qty. 1 Total South Elevation = 60 S.F.
- 3. Typical banner 6'x 6' printed perforated canvas with finished seams; occurs at open bays.
Typical Sign Area = 36 S.F.
Qty. 6 Total South Elevation = 216 S.F.
- 4. Typical banner 4'x20' printed canvas x 3 sides.
Typical Sign Area = 240 S.F.
Qty. 3 Total South Elevation = 720 S.F.
- 5. Window film signs. Sizes vary.
Typical Sign Area = 64 S.F.
Qty. 2 Total South Elevation = 128 S.F.
- 6. "LICENSE CENTER" brushed aluminum letters
Typical Sign Area = 60 S.F.
Qty. 1 Total South Elevation = 60 S.F.

Ramp Elevation & Sign Area Calculations:

South Elevation:

Total Elevation Area = ±15,589 S.F.
 Total Allowable Sign Area (15% Elevation Area) = ±2,338 S.F.
 Total Proposed Sign Area Used = 1250 S.F.



Landform® and Site to Finish® are registered service marks of Landform Professional Services, LLC.