

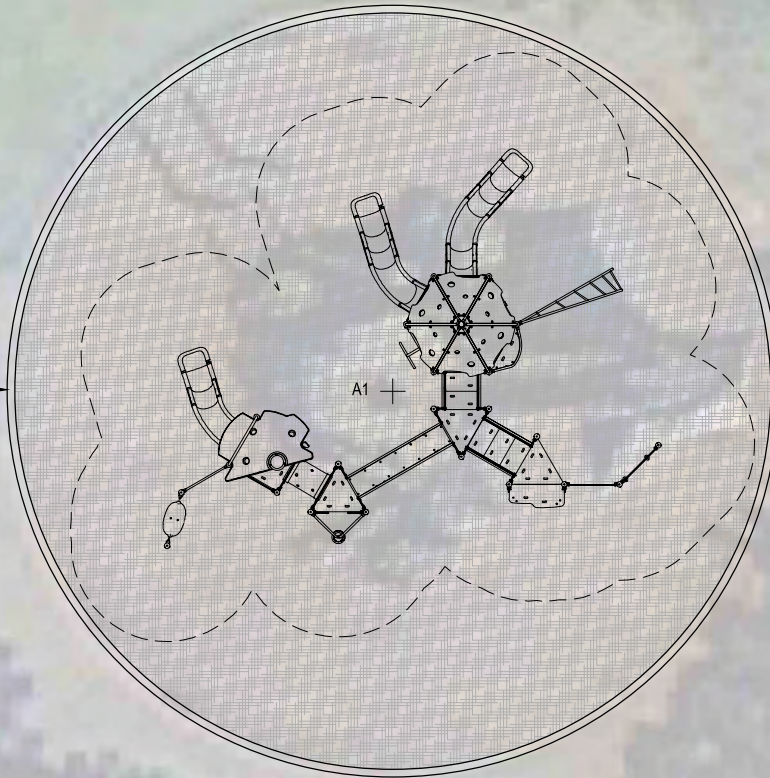

Ø49'-7 3/4"
[Ø1513cm]



TOTAL EWF SURFACING AREA: 1860 SF

6" CONCRETE BORDERS
PERIMETER: 156 LF

#	Product Number	Product Name	M.F.H.	Count
A	PCE410132-x02	Denali with Roof	7'3"	1

ALPINE PARK
CITY OF RAMSEY
6600 Alpine Drive NW
Anoka, MN
Site Plan - Option 1



MANUFACTURER'S SHOP DRAWING:

FOR USE BY CONTRACTOR, ENGINEER, OR DESIGN PROFESSIONAL OF RECORD; SEE BIDDING SALES PROPOSAL FOR COMPLETE SCOPE TO BE PROVIDED BY COMPANY OR PROVIDING AGENCY. CONSULT FINAL PLAN AND SCOPE WITH KOMPAN SALES REP OR PROJECT MANAGER PRIOR TO USE FOR PERMITS, ON CONSTRUCTION, PROCESSING, PROVIDED TO USE EQUIPMENT IN COMPLIANCE WITH ALL APPLICABLE REGULATIONS AND STANDARDS. TO BE READ CONJUNCTIVELY WITH KOMPAN STANDARDS FOR SITE PREPARATION, MATERIALS AND INSTALLATION PROCESSES. PROVIDED TO USE EQUIPMENT IN COMPLIANCE WITH ALL APPLICABLE REGULATIONS AND STANDARDS. SAFETY: ALL REQUIREMENTS IN THE CODE OF CONDUCT.

SLAB BY OTHERS UNLESS OTHERWISE NOTED FOR SURFACE MOUNT OPTIONS; THE CONCRETE REQUIREMENTS MAY BE UP TO 5% OF SLAB FOR MANUALLY COMPRESSED STRENGTH. CONTACT KOMPAN FOR SPECIFIC PRODUCT REQUIREMENTS. ALL COMPOSITE STRUCTURES SHOWN REQUIRE A SITE GRADE OF 2% MAXIMUM IN OPTIMAL SPECIFICATIONS FOR EACH KOMPAN STRUCTURE. MAY BE FOUND AT: WWW.KOMPAN.COM OR MANAGER.

DIMENSIONS OF PLAY AREA, SITE AND ORIENTATION, LOCATIONS OF ALL EXISTING UTILITIES, EQUIPMENT AND SITE FURNISHINGS TO BE FIELD VERIFIED PRIOR TO CONSTRUCTION.

PREPARED AND PRINTED IN USA BY KOMPAN © 2023 KOMPAN, INC., AUSTIN, TX, USA 800-254-9188

KOMPAN!
Let's play

SALES REPRESENTATIVE			SHEET
John Engler			K1.0
REVIEW BY DESIGN	DRAWN BY SuSub	DATE 01/02/2024	
REV. NO.	REV. BY	REV. DATE	REVISION NOTES
-	-	-	-

LAYOUT B IN ACCORDANCE WITH ASTM F447

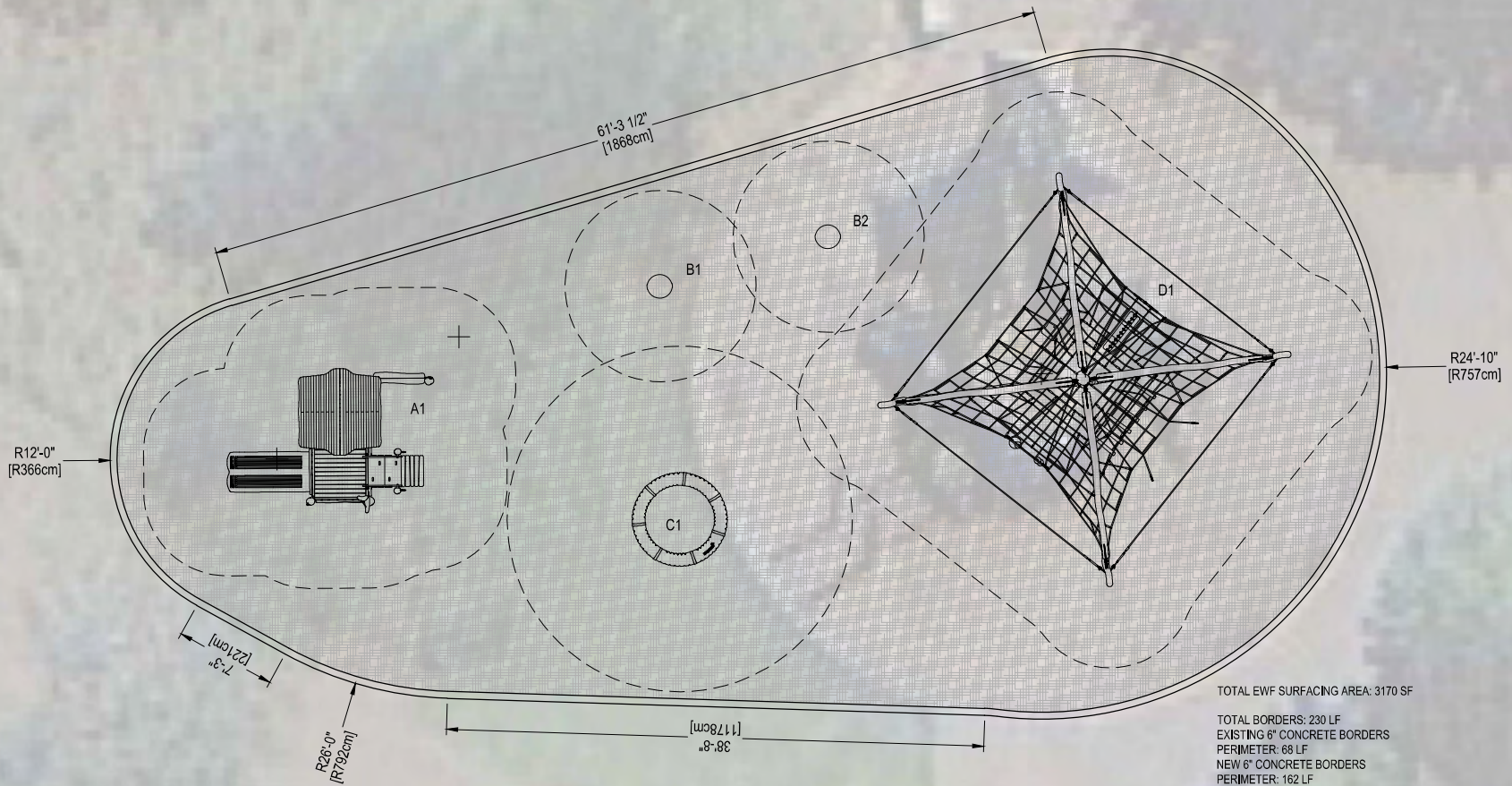

TOTAL EWF SURFACING AREA: 3170 SF

TOTAL BORDERS: 230 LF
 EXISTING 6" CONCRETE BORDERS
 PERIMETER: 68 LF
 NEW 6" CONCRETE BORDERS
 PERIMETER: 162 LF

#	Product Number	Product Name	M.F.H.	Count
A	NR0409-xx21	The Wizard's Hideaway	211'	1
B	ELE40034-xx17SC	Spinner Bowl	112'	2
C	GXY980014-xx17	Supernova	24'	1
D	NR0836-xx01	Jungle Dome	7'10"	1

ALPINE PARK
CITY OF RAMSEY
 6600 Alpine Drive NW
 Anoka, MN
 Site Plan - Option 2



MANUFACTURER'S SHOP DRAWING:

FOR USE BY CONTRACTOR, ENGINEER, OR DESIGN PROFESSIONAL OF RECORD. SEE BIDDING SALES PROPOSAL FOR COMPLETE SCOPE TO BE PROVIDED BY CONTRACTOR/PROFESSIONAL AGENCY. CONSULT FINAL PLAN AND SCOPE WITH KOMPAN SALES REP OR PROJECT MANAGER PRIOR TO USE FOR PERMITS, PERMITTING, OR CONSTRUCTION. TO BE READ CONJUNCTIVELY WITH KOMPAN STANDARDS FOR SITE PREPARATION, MATERIALS AND INSTALLATION PROCESSES PROVIDED BY EQUIPMENT PURCHASER. A COMPLIANT PLAYGROUND CONFORMANCE IS REQUIRED FOR SAFETY. ALL REQUIREMENTS IN THE CODES OF CONDUCT.

SLAB BY OTHERS UNLESS OTHERWISE NOTED FOR SURFACE MOUNT OPTIONS. THE CONCRETE REQUIREMENTS MAY BE UP TO 5% OF SLAB FOR MINIMUM COMPRESSIVE STRENGTH. CONTACT KOMPAN FOR SPECIFIC PRODUCT REQUIREMENTS. ALL CONCRETE STRUCTURES SHOWN REQUIRE A SITE GRADE OF 2% MAXIMUM (% OPTIMAL) SPECIFICATIONS FOR EACH KOMPAN STRUCTURE MAY BE FOUND AT WWW.KOMPAN.COM OR MANAGER.

DIMENSIONS OF PLAY AREA, SITE AND ORIENTATION, LOCATIONS OF ALL EXISTING UTILITIES, EQUIPMENT AND SITE FURNISHINGS TO BE FIELD VERIFIED PRIOR TO CONSTRUCTION.

PREPARED AND PRINTED IN USA BY KOMPAN © 2023 KOMPAN, INC., AUSTIN, TX, USA 8004264787



SALES REPRESENTATIVE			SHEET	
John Engler			K1.0	
REVIEW BY	DRAWN BY	DATE		
DESIGN	SusSub	01/02/2024		
REV. NO.	REV. BY	REV. DATE	REVISION NOTES	
-	-	-	-	

LAYOUT B IN ACCORDANCE WITH ASTM F481

ST. CROIX



RECREATION

FunPlaygrounds.com

Option A

St. Croix Recreation Fun Playgrounds INC.
1826 Tower Dr W
Stillwater, MN 55082 US
16514301247
hannah@stcroixrec.com



Estimate

ESTIMATE # 6731

DATE 01/08/2024

EXPIRATION DATE 02/29/2024

ADDRESS

City of Ramsey
ALPINE PARK
PROPOSAL [REDACTED]

SHIP TO

City of Ramsey
Attn: Parks Department
14100 Jasper St NW
Ramsey, MN 55303
ATTN: MARIAH
ALBRECHT

PLEASE DETACH TOP PORTION AND RETURN WITH YOUR PAYMENT.

SHIP VIA
TRUCKLOAD

SALES REP
MIKE BASICH

ACTIVITY	QTY	RATE	AMOUNT
BCI 100-178955-1 BURKE CUSTOM PLAY ENVIRONMENT AS DEPICTED IN IMAGES AND DOCUMENTS ATTACHED AND IDENTIFIED AS PR#100-178955-1 (ALPINE PARK OPTION A)	1	67,953.00	67,953.00
Freight Freight quotes currently only valid for 15 days. Quote based on information currently listed on estimate. Modifications to delivery address, contact or offloading capability must be made prior to order. If made after order is placed, surcharges may apply.	1	3,500.00	3,500.00
Concrete Curb 175 Linear Feet of 6" wide by 12" tall concrete curb rectangular on prepared grade- w/2 # 4rebar continuous	175	43.00	7,525.00
ENGINEERED WOOD FIBER ENGINEERED WOOD FIBER 12" COMPACTED DEPTH	180	43.00	7,740.00
SF RUBBER RESILIENT 215 SQUARE FEET RUBBER PIP 50% BLACK 50% GREEN AT SWINGS	1	6,880.00	6,880.00
INSTALLATION *Please reference project manager/installer directly for specific scope of work, and/or additional information found in email correspondence, proposals, and estimates.	1	16,000.00	16,000.00
APPLIED DISCOUNT ADDITIONAL MFG. DISCOUNT APPLIED	1	-9,598.00	-9,598.00

MATERIAL ITEMS AS QUOTED ARE GOOD FOR 30 DAYS. FREIGHT QUOTES ARE GOOD FOR 15 DUE TO FUEL UNCERTAINTIES. SALES TAX SUBJECT TO CHANGE. ADD IF NOT TAX EXEMPT OR SUPPLY EXEMPTION CERTIFICATE IF NOT ON FILE. PAYMENT TERMS ARE NET 30 DAYS UNLESS OTHERWISE NOTED. FAILURE TO PAY IN A TIMELY MANNER WILL BE SUBJECT TO INTEREST AT A RATE OF 1.5%/MONTH OR 18% ANNUALLY.

TOTAL

\$100,000.00

By signing estimate or authorizing by email or PO, purchaser is agreeing to billing terms as listed on the estimate. Order to include model number(s), quantity and color(s) above including any supplemental documents provided and/or requested. Please verify all content for accuracy. **Those purchasing off of the MN State Contract are bound only by the terms and conditions listed in said contract**

*LEAD TIMES AND SHIPPING DATES ARE BASED ON CURRENT INVENTORY. PLEASE BE PATIENT AS OUR VENDORS NAVIGATE SUPPLY CHAINS & NATIONAL SHORTAGES.

**FOR BIDDING CONTRACTORS & SUPPLIERS: ST CROIX RECREATION IS NOT LIABLE FOR INTERPRETATION OF PROJECT BIDS, DRAWINGS OR ADDENDA. IT IS THE CUSTOMER'S RESPONSIBILITY TO VERIFY ACCURACY OF MODEL NUMBER(S), DESCRIPTION(S), QUANTITY AND COLOR(S) DIRECTLY WITH END USER

Accepted By

Accepted Date

By signing estimate or authorizing by email or PO, purchaser is agreeing to billing terms as listed on the estimate. Order to include model number(s), quantity and color(s) above including any supplemental documents provided and/or requested. Please verify all content for accuracy. **Those purchasing off of the MN State Contract are bound only by the terms and conditions listed in said contract**

Option A



St. Croix Recreation Fun Playgrounds Inc.

1826 Tower Dr W | Stillwater, MN 55082 | 651-430-1247

Proposal 100-178955-1 | 1/4/2024

OUR MISSION IS TO BRING
PLAY THAT MOVES YOU.
TO COMMUNITIES AROUND
THE WORLD

January 04, 2024

Mariah Albrecht
City of Ramsey Parks
7550 Sunwood Dr NW
Ramsey, MN 55303-5137
Phone: 763-433-9820

Dear Mariah Albrecht:

St. Croix Recreation Fun Playgrounds Inc. is delighted to provide City of Ramsey Parks with this playground equipment proposal.

This design was developed with your specific needs in mind, and we look forward to discussing this project further with you to ensure your complete satisfaction. St. Croix Recreation Fun Playgrounds Inc. is confident that this proposal will satisfy City of Ramsey Parks's functional, environmental, and safety requirements -- and most importantly -- bring joy and excitement to the children and families directly benefiting from your new playground.

You have our personal commitment to support this project and your organization in every manner possible, and we look forward to developing a long-standing relationship with City of Ramsey Parks. We appreciate your consideration and value this opportunity to earn your business.

Sincerely,

Mike Basich
Sales Representative

St. Croix Recreation Fun Playgrounds Inc.
1826 Tower Dr W
Stillwater, MN 55082
www.funplaygrounds.com
www.bciburke.com

Phone: 651-430-1247
Fax: -
mb@stcroixrec.com

OUR MISSION IS TO BRING
PLAY THAT MOVES YOU[®]
TO COMMUNITIES AROUND
THE WORLD

COOPERATIVE PURCHASING OPTIONS

PLAYGROUNDS WITHOUT ALL THE PAPERWORK

Purchasing with contracts may sound intimidating, but getting your community playspace doesn't need to be a painful process of writing specifications, issuing RFP's and jumping through hoops – it can be simplified – we promise! As you continue planning for your new playground, review the Purchasing Contracts offered through our partners.

EQUALIS GROUP

Equalis is an innovative cooperative purchasing organization that believes in the power of partnership and that when you work together you achieve more. The basic premise of the Equalis cooperative purchasing organization is to leverage the combined buying power of all members for better pricing and favorable contract terms. Equalis Group uses the lead agency model for competitively bid contracts, provides our participants the savings they expect and offers efficiencies and peace of mind within the procurement process. It is our mission to continuously improve the measurable and meaningful impact of cooperative services for everyone throughout the supply chain.

GOVMVMT

GOVMVMT is a non-profit group purchasing organization that meets the highest industry standards while putting the public's interest at the forefront of everything they do. Each one of GOVMVMT's first-class suppliers has consciously joined their mission to create the most credible, ethical, and public agency-focused non-profit cooperative purchasing program in the country.

GSA

Federal parks, child development programs, military bases and other agencies are a major priority for BCI Burke, and agencies can purchase Burke playgrounds through Burke's GSA contract for installation virtually anywhere in the world.

OMNIA PARTNERS

OMNIA Partners, Public Sector (Subsidiary National IPA) is the largest and most experienced organization in purchasing and supply chain management. Comprised of participants and suppliers in the public sector, we bring together industry-leading buying power and world-class suppliers to offer an extensive portfolio of competitively solicited and publicly awarded contracts and partnerships. OMNIA Partners is proud to offer more value and resources to state and local government, higher education, K-12 education and non-profits.

SOURCEWELL

As a leader in cooperative purchasing, Sourcewell is passionate about helping members fulfill their public service missions. Sourcewell builds strong relationships with members and vendors to develop practical solutions together.

The easiest way to Join Our Movement is to call your local Representative at 800.266.1250 or visit bciburke.com/rep. Our passion is bringing play to communities like yours and we can't wait to help you get started!



Option A

DESIGN SUMMARY

St. Croix Recreation Fun Playgrounds Inc. is very pleased to present this Proposal for consideration for the Alpine Park located in Ramsey. BCI Burke Company, LLC has been providing recreational playground equipment for over 100 years and has developed the right mix of world-class capabilities to meet the initial and continuing needs of City of Ramsey Parks. We believe our proposal will meet or exceed your project's requirements and will deliver the greatest value to you.

The following is a summary of some of the key elements of our Proposal:

- Project Name: Alpine Park
- Project Number: 100-178955-1
- User Capacity: 47
- Age Groups: 5 to 12
- Dimensions: 77' 6"x75' 10"
- Designer Name: Leah Kirssin

St. Croix Recreation Fun Playgrounds Inc. has developed a custom playground configuration based on the requirements as they have been presented for the Alpine Park playground project. Our custom design will provide a safe and affordable playground environment that is aesthetically pleasing, full of fun for all users and uniquely satisfies your specific requirements. In addition, proposal # 100-178955-1 has been designed with a focus on safety, and is fully compliant with ASTM F1487 and CPSC playground safety standards.

We invite you to review this proposal for the Alpine Park playground project and to contact us with any questions that you may have.

Thank you in advance for giving us the opportunity to make this project a success.

Option A

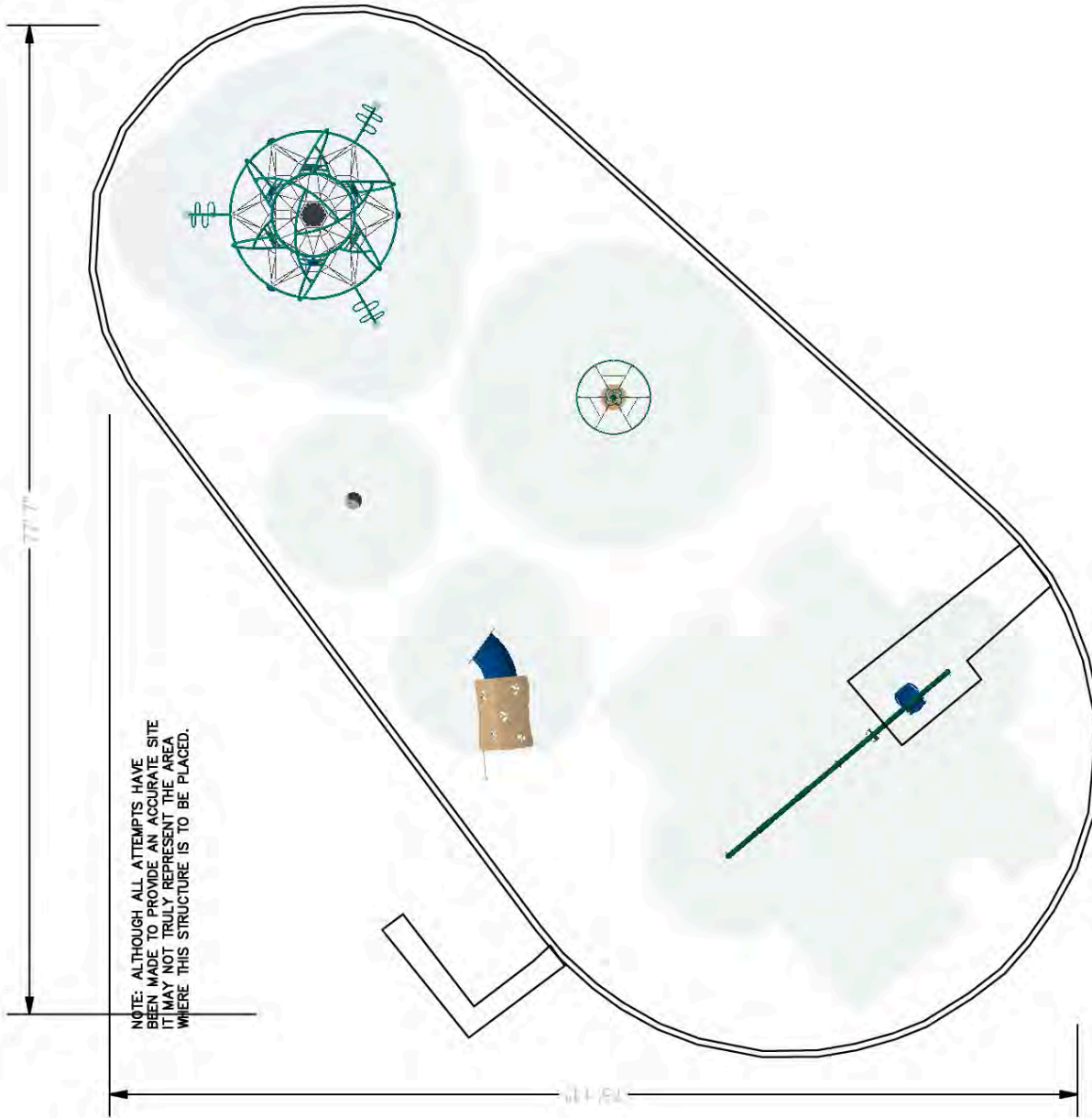

NOTE: ALTHOUGH ALL ATTEMPTS HAVE BEEN MADE TO PROVIDE AN ACCURATE SITE PLAN, IT MAY NOT TRULY REPRESENT THE AREA WHERE THIS STRUCTURE IS TO BE PLACED.

The use and layout of play components identified in this plan conform to the CPSC guidelines. U.S. CPSC recommends the separation of age groups in playground layouts.

PLAYGROUND ACCESSIBILITY (Provided/Required)			
TOTAL ELEVATED EVENTS	TRANSFER ACCESSIBLE EVENTS	RAMP ACCESSIBLE EVENTS	TYPES OF GROUND EVENTS
9	4 / 2	0 / 0	7 / 1 4 / 1

OVERALL BOUNDING OF USE ZONES **The space requirements shown here are to ASTM standards. Requirements for other standards may be different.

Area: 5887.8 sq.ft.
 Perimeter: 306.9 ft.
STRUCTURE SIZE: 11"x77' 7"
POST SIZE(S):

Warning: Accessible safety surfacing material is required beneath and around this equipment that is compliant with ASTM, CPSC, and ADAAG requirements.

SERIES Burke Basics	SITE PLAN VIEW	
GROUP: BB-2765 Free Standing	Alpine Park Ramsey, MN 55303	01/04/2024
DESIGNED FOR AGES: 5 to 12	Burke PLAY THAT MOVES YOU.	St. Croix Recreation Fun Playgrounds 100-178955-1 Designer: Leah Kirssin
BCI BURKE COMPANY, LLC PO BOX 549 FOND DU LAC, WI 54936-0549 920.921.9220 BCIBURKE.COM		

Option A

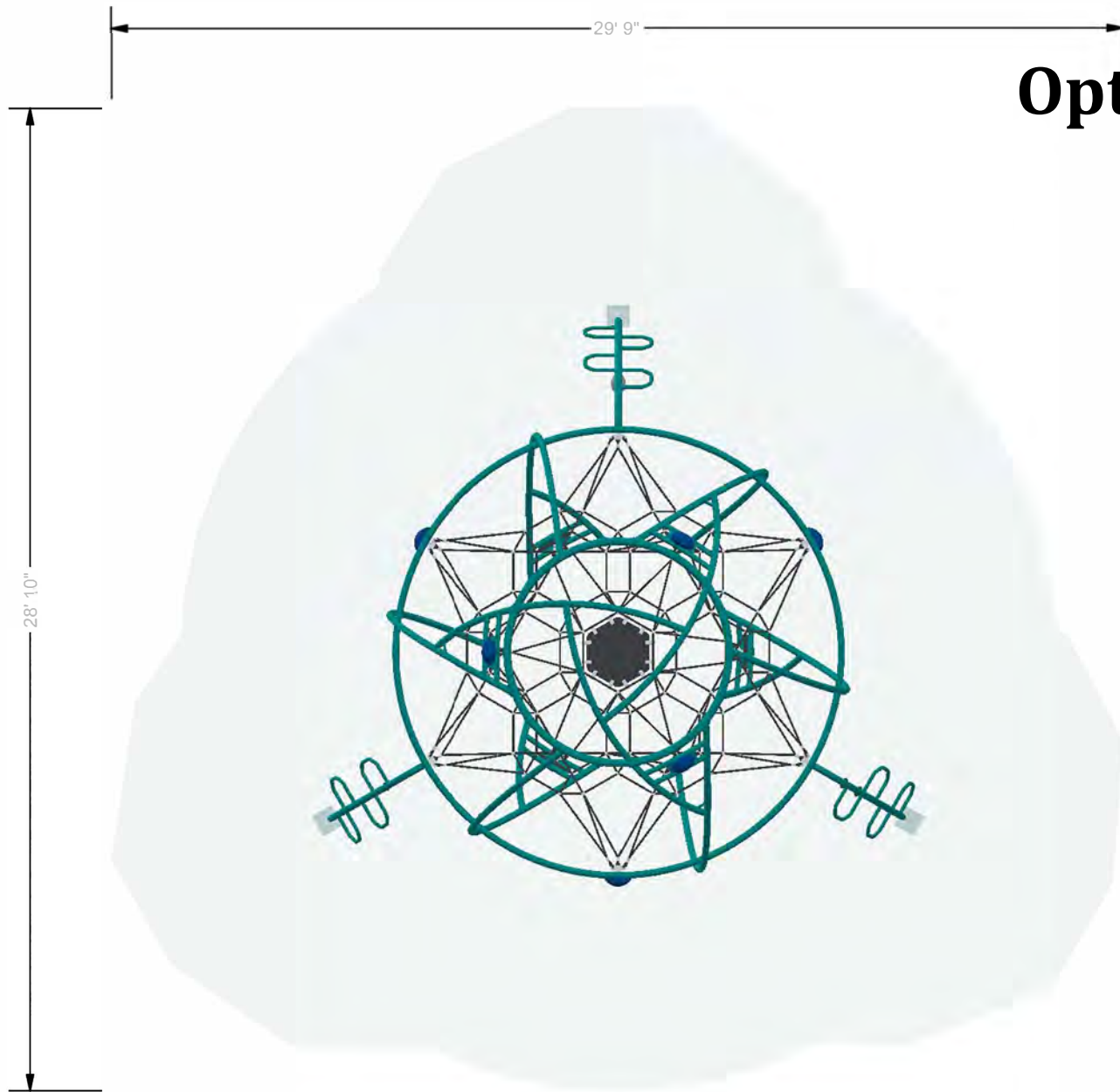

SERIES Burke Basics

GROUP:
BB-2765

DESIGNED FOR AGES:
5 to 12

Alpine Park

Ramsey, MN 55303

Burke
PLAY THAT MOVES YOU

SITE PLAN VIEW

01/04/2024

St. Croix Recreation Fun Playgrounds

100-178955-1

Designer: Leah Kirssin

BCI BURKE COMPANY, LLC | PO BOX 549 FOND DU LAC, WI 54936-0549 | 920.921.9220 | BCI.BURKE.COM

OVERALL BOUNDING OF USE ZONES

Area: 5887.8 sq.ft.
Perimeter: 306.9 ft.

STRUCTURE SIZE: 11"x77' 7"

POST SIZE(S):

**The space requirements shown here are to ASTM standards. Requirements for other standards may be different.

PLAYGROUND ACCESSIBILITY (Provided/Required)

TOTAL EVENTS	ELEVATED EVENTS	TRANSFER ACCESSIBLE EVENTS	RAMP ACCESSIBLE EVENTS	GROUND EVENTS	TYPES OF GROUND EVENTS
9	4 / 2	0 / 0	0 / 0	7 / 1	4 / 1

The use and layout of play components identified in this plan conform to the CPSC guidelines. U.S. CPSC recommends the separation of age groups in playground layouts.

Warning: Accessible safety surfacing material is required beneath and around this equipment that is compliant with ASTM, CPSC, and ADAAG requirements.

Option A

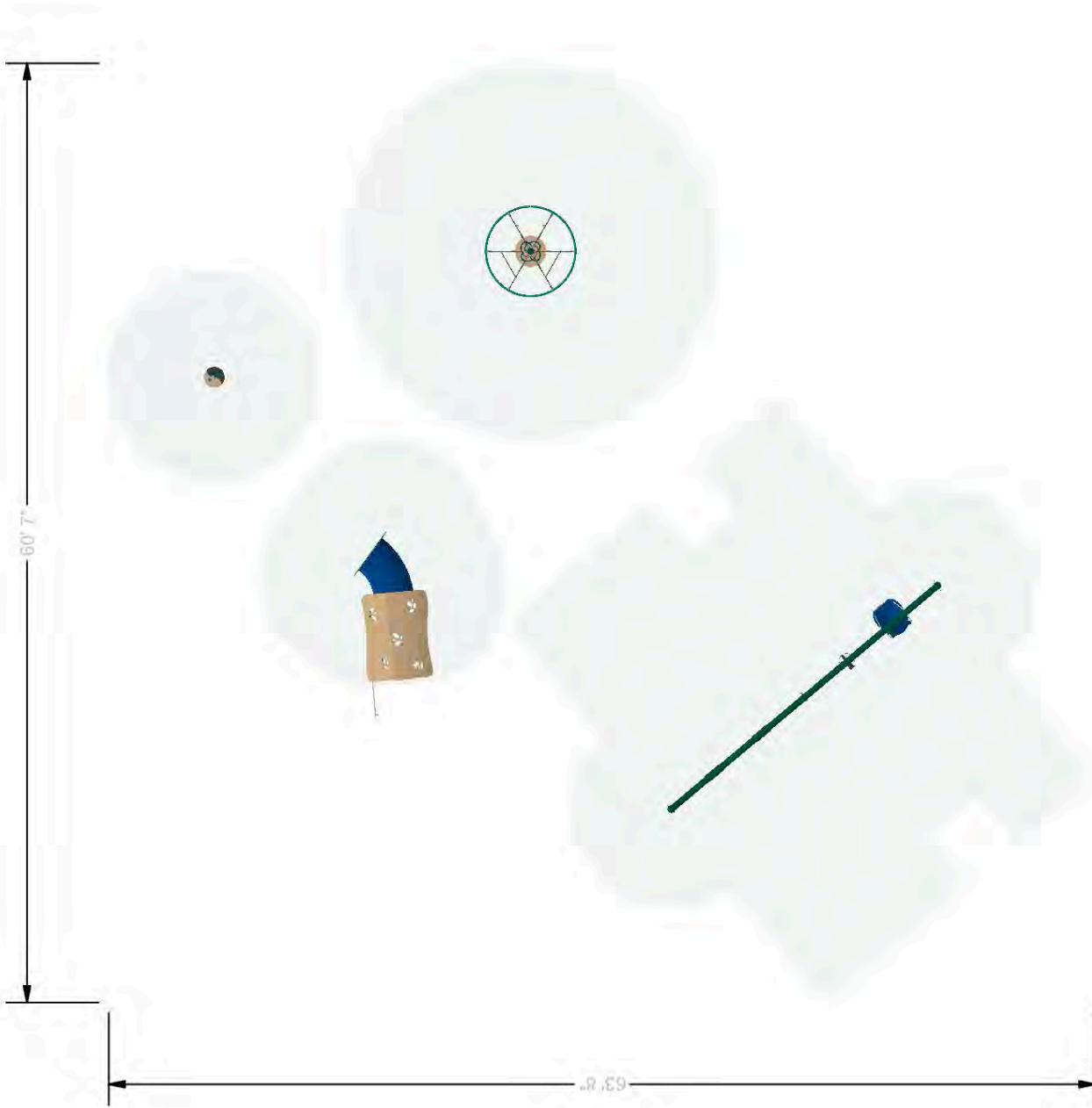

The use and layout of play components identified in this plan conform to the CPSC guidelines. U.S. CPSC recommends the separation of age groups in playground layouts.

PLAYGROUND ACCESSIBILITY (Provided/Required)			
TOTAL ELEVATED EVENTS	TRANSFER ACCESSIBLE EVENTS	RAMP ACCESSIBLE EVENTS	TYPES OF GROUND EVENTS
9	4 / 2	0 / 0	7 / 1 4 / 1

**The space requirements shown here are to ASTM standards. Requirements for other standards may be different.

OVERALL BOUNDING OF USE ZONES
 Area: 5887.8 sq.ft.
 Perimeter: 306.9 ft.
STRUCTURE SIZE: 11'x77' 7"
POST SIZE(S):

Warning: Accessible safety surfacing material is required beneath and around this equipment that is compliant with ASTM, CPSC, and ADAAG requirements.

SERIES Burke Basics

SITE PLAN VIEW

GROUP:
Free Standing

Alpine Park
Ramsey, MN 55303

01/04/2024

DESIGNED FOR AGES:
5 to 12



St. Croix Recreation Fun Playgrounds
100-178955-1

Designer: Leah Kirssin

Option A

ITEM	COMP.	DESCRIPTION
1	560-2587	ROPEVENTURE REVOLV
2	560-2600	REVOLV ATTACHMENT CLIMBER-RAINDROPS
3	560-2597	REVOLV ATTACHMENT CLIMBER- BUBBLE MIRROR
4	560-2599	REVOLV ATTACHMENT CLIMBER- HYPNO

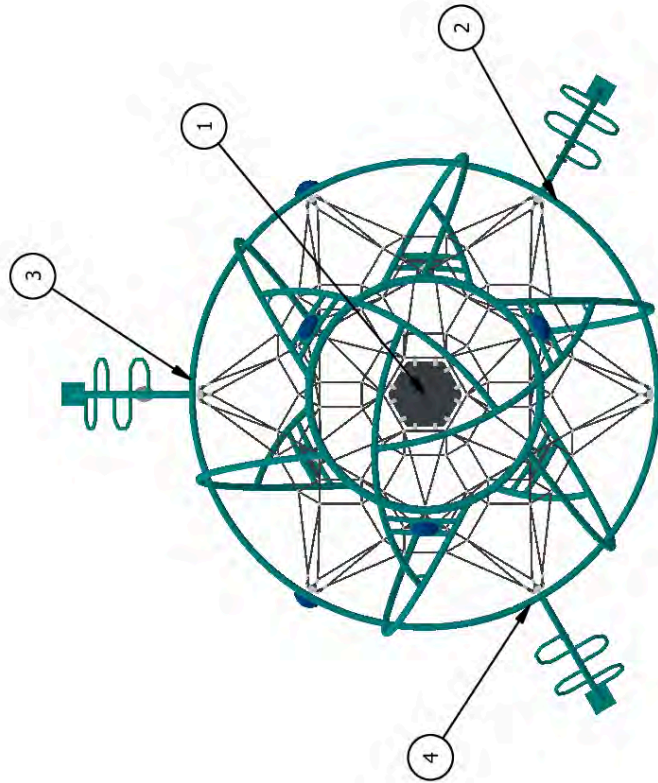

SERIES Burke Basics

COMPONENT VIEW

GROUP:
BB-2765

Alpine Park
Ramsey, MN 55303

01/04/2024

DESIGNED FOR AGES:
5 to 12

St. Croix Recreation Fun Playgrounds
100-176955-1

Burke
PLAY THAT MOVES YOU

Designer: Leah Kirssin

Option A

ITEM	COMP.	DESCRIPTION
1	550-0201	SINGLE POST SWING ASSEMBLY 5" OD
2	550-0202	SINGLE POST SWING ADD-ON 5" OD
3	550-0111	BELT SEAT, 8' SINGLE, STD CHAIN
4	550-0171	FREEDOM SWING SEAT, 8' BEAM, STD CHAIN
5	550-0099	TOT SEAT, 7' & 8' SINGLE, STD CHAIN
6	580-1376	PLAYHOUSE WITH TUNNEL
7	580-1374	FENCE, PLAYHOUSE TO FS
8	560-0457	SWIFT TWIST SPINNER
9	560-2611	SPINETIC W/O SPEED LIMITER

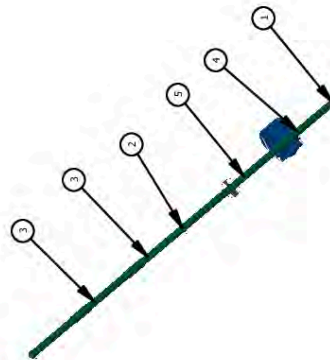
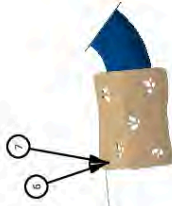

SERIES Burke Basics

COMPONENT VIEW

GROUP:
Free Standing

Alpine Park
Ramsey, MN 55303

01/04/2024

DESIGNED FOR AGES:
5 to 12

St. Croix Recreation Fun Playgrounds
100-176955-1

Burke
PLAY THAT MOVES YOU

Designer: Leah Kirssin

Option A

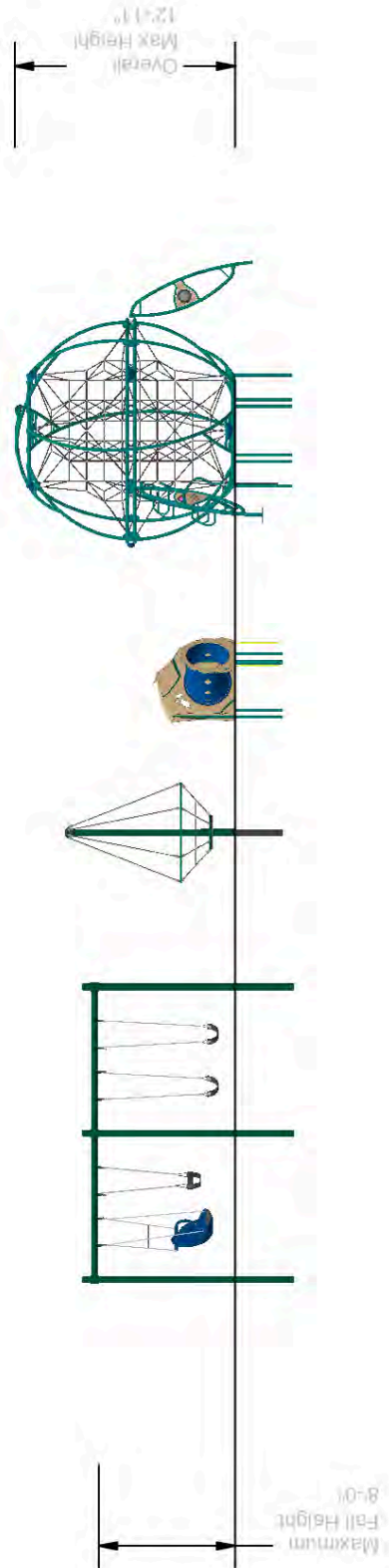

SERIES Burke Basics

ELEVATION VIEW

GROUP:
BB-2765|Free Standing

Alpine Park
Ramsey, MN 55303

01/04/2024

DESIGNED FOR AGES:
5 to 12

St. Croix Recreation Fun Playgrounds
100-178955-1

Designer: Leah Kirssin

Burke
PLAY THAT MOVES YOU

Option A

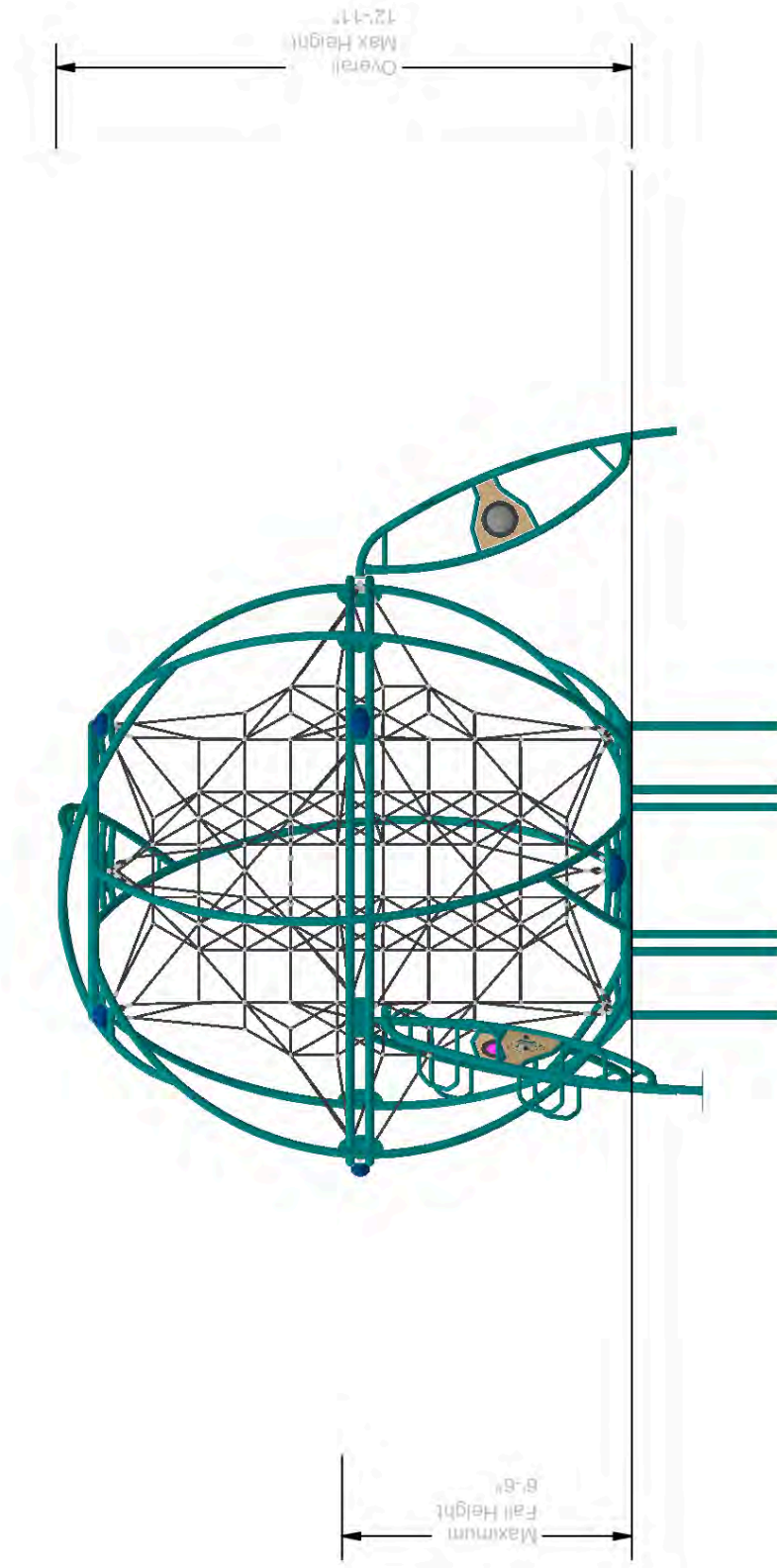

SERIES Burke Basics		ELEVATION VIEW
GROUP: BB-2765	Alpine Park Ramsey, MN 55303	01/04/2024
DESIGNED FOR AGES: 5 to 12	Burke PLAY THAT MOVES YOU	St. Croix Recreation Fun Playgrounds 100-178955-1
Designer: Leah Kirssin		
BCI BURKE COMPANY, LLC PO BOX 549 FOND DU LAC, WI 54936-0549 920.921.9220 BCIBURKE.COM		

Option A

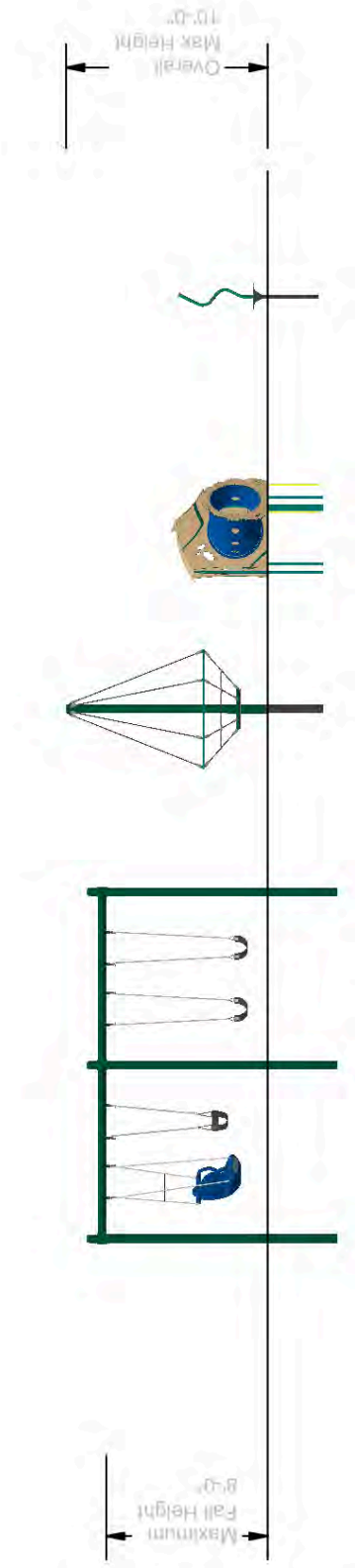

SERIES Burke Basics	ELEVATION VIEW
GROUP: Free Standing	01/04/2024
DESIGNED FOR AGES: 5 to 12	St. Croix Recreation Fun Playgrounds 100-176955-1
Alpine Park Ramsey, MN 55303	Designer: Leah Kirssin
Burke PLAY THAT MOVES YOU	
BCI BURKE COMPANY, LLC PO BOX 549 FOND DU LAC, WI 54936-0549 920.921.9220 BCIBURKE.COM	

Option A

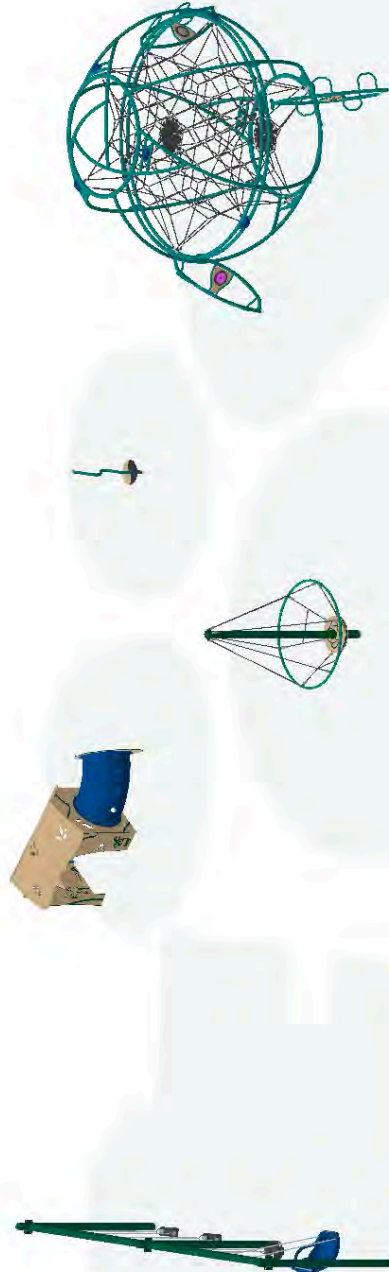

SERIES Burke Basics

GROUP:
BB-2765|Free Standing

DESIGNED FOR AGES:
5 to 12

Alpine Park
Ramsey, MN 55303

Burke
PLAY THAT MOVES YOU

ISOMETRIC VIEW

01/04/2024

St. Croix Recreation Fun Playgrounds
100-176955-1

Designer: Leah Kirssin

Option A

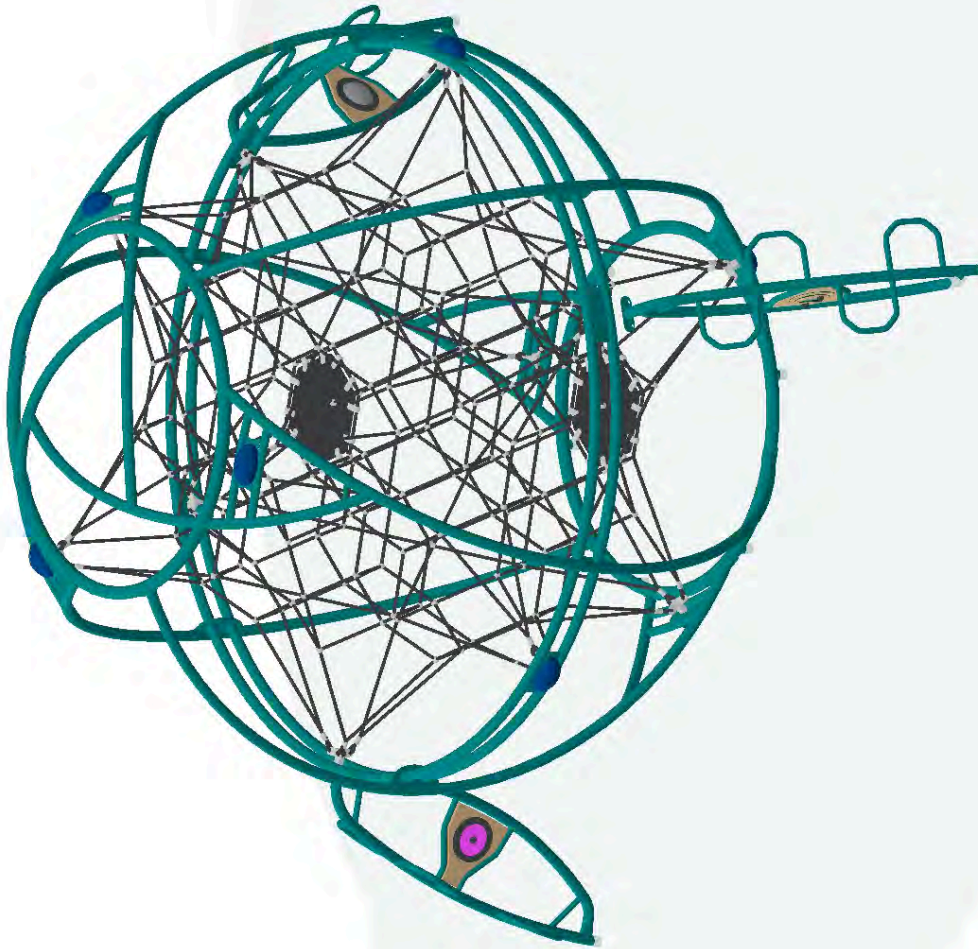

SERIES Burke Basics

GROUP:
BB-2765

DESIGNED FOR AGES:
5 to 12

Alpine Park

Ramsey, MN 55303

Burke
PLAY THAT MOVES YOU

ISOMETRIC VIEW

01/04/2024

St. Croix Recreation Fun Playgrounds
100-178955-1

Designer: Leah Kirssin

Option A

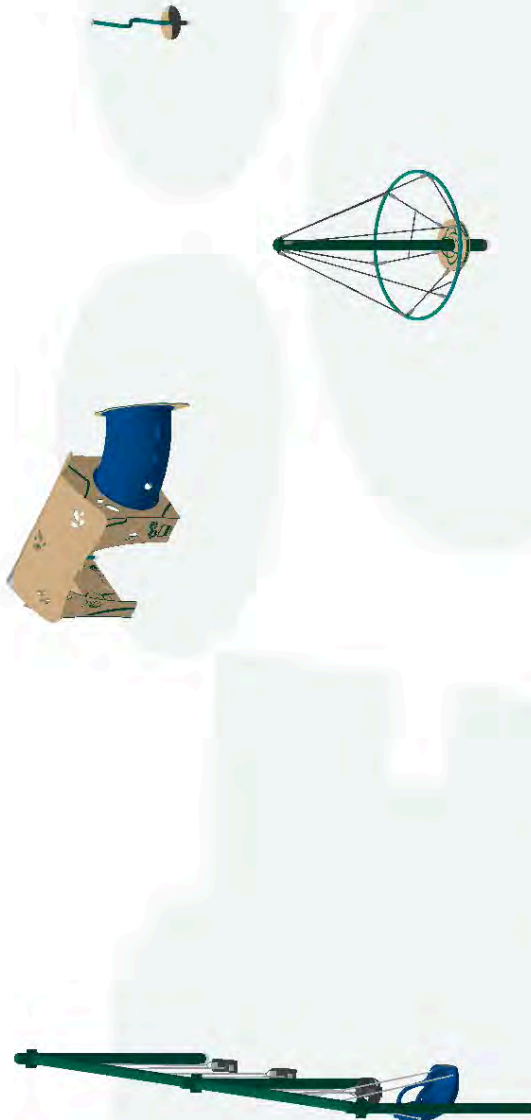

SERIES Burke Basics

ISOMETRIC VIEW

GROUP:
Free Standing

Alpine Park
Ramsey, MN 55303

01/04/2024

DESIGNED FOR AGES:
5 to 12

St. Croix Recreation Fun Playgrounds
100-178955-1

Designer: Leah Kirssin

Burke
PLAY THAT MOVES YOU

The play components identified in this proposal are IPEMA certified. The use and layout of these components conform to the requirements of ASTM F1487. To verify product certification, visit www.ipema.org.



The space requirements shown in this proposal are to ASTM standards. Requirements for other standards may be different.

Component No.	Description	Qty	User Cap	Ext. User Cap	Weight	Ext. Weight
---------------	-------------	-----	----------	---------------	--------	-------------

BB-2765

Burke Basics

560-2587	ROPEVENTURE REVOLV	1	18	18	2059	2059
560-2597	REVOLV ATTACHMENT CLIMBER- BU...	1	2	2	75	75
560-2599	REVOLV ATTACHMENT CLIMBER- HYPNO	1	2	2	76	76
560-2600	REVOLV ATTACHMENT CLIMBER-RAI...	1	2	2	76	76
660-0101	INSTALL KIT, BURKE BASICS - P...	1	0	0	2	2

Total User Capacity: 24
Total Weight: 2288 lbs.
Total Price: \$47,825

Free Standing

Burke Basics

550-0099	TOT SEAT, 7' & 8' SINGLE, STD...	1	1	1	12	12
550-0111	BELT SEAT, 8' SINGLE, STD CHAIN	2	1	2	10	20
550-0171	FREEDOM SWING SEAT, 8' BEAM, ...	1	1	1	38	38
550-0201	SINGLE POST SWING ASSEMBLY 5" OD	1	0	0	220	220
550-0202	SINGLE POST SWING ADD-ON 5" OD	1	0	0	145	145
560-0457	SWIFT TWIST SPINNER	1	1	1	52	52
560-2611	SPINETIC W/O SPEED LIMITER	1	8	8	257	257
580-1374	FENCE, PLAYHOUSE TO FS	1	2	2	27	27
580-1376	PLAYHOUSE WITH TUNNEL	1	8	8	400	400
660-0100	INSTALL KIT, BURKE BASICS - P...	1	0	0	2	2

Total User Capacity: 23
Total Weight: 1173 lbs.
Total Price: \$20,128

Special Notes:

Prices do not include freight, unloading, material storage, site excavation/preparation, removal of existing equipment, removal of excess soil from footing holes, site security, safety surfacing, installation, or sales tax (if applicable). Prices are based on standard colors per CURRENT YEAR BCI Burke Catalog. Custom colors, where available, would be an extra charge. **Pricing is valid for 30 days from the date of this proposal.**

Option A

COLOR SELECTION LIST | Default Color Option

GROUP 1 (BB-2765)

Acc: Aqua
Plastic: Blue
Panel: Tan-Green-Tan
Flat: Tan

GROUP 2 (Free Standing)

Post: Green
Deck: Brown
Plastic: Blue
Acc: Aqua
Panel: Tan-Green-Tan
Flat: Tan

Option A

COLORS THAT MOVE YOU

POWDER COAT PAINT



SOLIS HUE TOPPERS

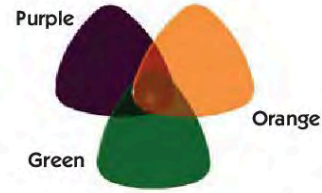

ROCKIT CLIMBERS

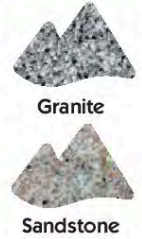

PLATFORMS



HDPE PLASTIC PANELS

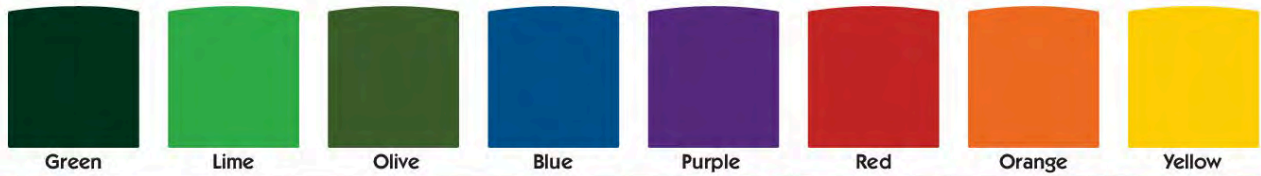

SHADE CANOPIES

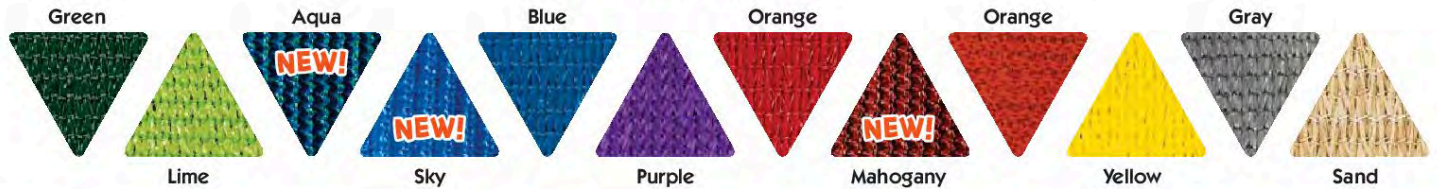

ROTOMOLD PLASTIC

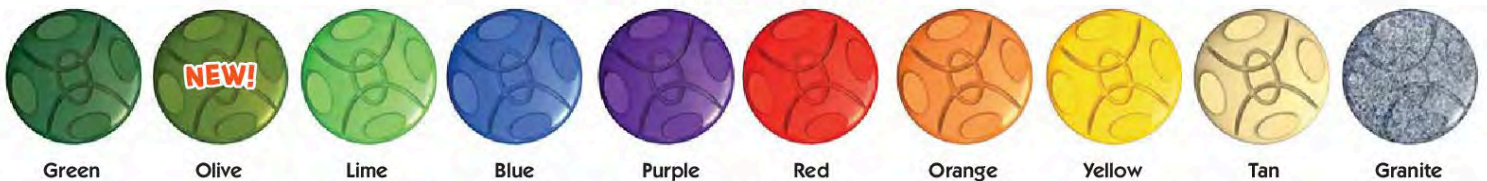

VISIT BCIBURKE.COM/COLOR TO CUSTOMIZE YOUR PLAYGROUND COLORS!

BURKE GENERATIONS WARRANTY®

The Longest and Strongest warranty in the industry

BCI Burke Company, LLC ("Burke") warrants that all standard products are warranted to be free from defects in materials and workmanship, under normal use and service, for a period of one (1) year from the date of shipment.

We stand behind our products. In addition, the following products are warranted, under normal use and service from the date of shipment as follows:

- One Hundred (100) Year Limited Warranty on aluminum and steel upright posts (including Intensity®, Synergy™, Nucleus®, Voltage®, Little Buddies®, ELEVATE®, ACTIVATE®, INVIGORATE™) against structural failure due to corrosion, deterioration or workmanship.
- One Hundred (100) Year Limited Warranty on KoreKonekt® clamps against structural failure due to corrosion, deterioration or workmanship.
- One Hundred (100) Year Limited Warranty on Hardware (nuts, bolts, washers)
- One Hundred (100) Year Limited Warranty on bolt-through fastening and clamp systems (Synergy™, Intensity®, Nucleus®, Voltage®, Little Buddies®, ELEVATE®).
- Twenty-Five (25) Year Limited Warranty on spring assemblies and aluminum cast animals.
- Fifteen (15) Year Limited Warranty on structure platforms and decks, metal roofs, table tops, bench tops, railings and barriers against structural failure due to materials or workmanship.
- Fifteen (15) Year Limited Warranty on all plastic components including StoneBorders against structural failure due to materials or workmanship.
- Ten (10) Year Limited Warranty on ShadePlay Canopies fabric, threads, and cables against degradation, cracking or material breakdown resulting from ultra-violet exposure, natural deterioration or manufacturing defects. This warranty is limited to the design loads as stated in the specifications.
- Ten (10) Year Limited Warranty on NaturePlay® Boulders and GFRC products against structural failure due to natural deterioration or workmanship. Natural wear, which may occur with any concrete product with age, is excluded from this warranty.
- Ten (10) Year Limited Warranty on Full Color Custom Signage against manufacturing defects that cause delamination or degradation of the sign. Full Color Custom Signs also carry a two (2) year warranty against premature fading of the print and graphics on the signs.
- Five (5) Year Limited Warranty on Intensity® and RopeVenture® cables and LEVEL X® flex bridge against premature wear due to natural deterioration or manufacturing defects. Determination of premature wear will be at the manufacturer's discretion.
- Five (5) Year Limited Warranty on moving parts, including swing components, against structural failure due to materials or workmanship.
- Five (5) Year Limited Warranty on PlayEnsemble® cables and mallets against defects in materials and workmanship.
- Three (3) Year Limited Warranty on electronic panel speakers, sound chips and circuit boards against electronic failure caused by manufacturing defects.

The warranty stated above is valid only if the equipment is erected in conformity with the layout plan and/or installation instructions furnished by BCI Burke Company, LLC using approved parts; have been maintained and inspected in accordance with BCI Burke Company, LLC instructions. Burke's liability and your exclusive remedy hereunder will be limited to repair or replacement of those parts found in Burke's reasonable judgment to be defective. Any claim made within the above stated warranty periods must be made promptly after discovery of the defect. A part is covered only for the original warranty period of the applicable part. Replacement parts carry the applicable warranty from the date of shipment of the replacement from Burke. After the expiration of the warranty period, you must pay for all parts, transportation and service charges.

Burke reserves the right to accept or reject any claim in whole or in part. Burke will not accept the return of any product without its prior written approval. Burke will assume transportation charges for shipment of the returned product if it is returned in strict compliance with Burke's written instructions.

THE FOREGOING WARRANTIES ARE EXCLUSIVE AND IN LIEU OF ANY OTHER WARRANTY, EXPRESS OR IMPLIED, INCLUDING BUT NOT LIMITED TO ANY IMPLIED WARRANTY OF MERCHANTABILITY OR FITNESS FOR A PARTICULAR PURPOSE. IF THE FOREGOING DISCLAIMER OF ADDITIONAL WARRANTIES IS NOT GIVEN FULL FORCE AND EFFECT, ANY RESULTING ADDITIONAL WARRANTY SHALL BE LIMITED IN DURATION TO THE EXPRESS WARRANTIES AND BE OTHERWISE SUBJECT TO AND LIMITED BY THE TERMS OF BURKE'S PRODUCT WARRANTY. SOME STATES DO NOT ALLOW THE EXCLUSION OF CERTAIN IMPLIED WARRANTIES, SO THE ABOVE LIMITATION MAY NOT APPLY TO YOU.

Warranty Exclusions: The above stated warranties do not cover: "cosmetic" defects, such as scratches, dents, marring, or fading; damage due to incorrect installation, vandalism, misuse, accident, wear and tear from normal use, exposure to extreme weather; immersion in salt or chlorine water, unauthorized repair or modification, abnormal use, lack of maintenance, or other cause not within Burke's control; and

Limitation of Remedies: Burke is not liable for consequential or incidental damages, including but not limited to labor costs or lost profits resulting from the use of or inability to use the products or from the products being incorporated in or becoming a component of any other product. If, after a reasonable number of repeated efforts, Burke is unable to repair or replace a defective or nonconforming product, Burke shall have the option to accept return of the product, or part thereof, if such does not substantially impair its value, and return the purchase price as the buyer's entire and exclusive remedy. Without limiting the generality of the foregoing, Burke will not be responsible for labor costs involved in the removal of products or the installation of replacement products. Some states do not allow the exclusion of incidental damages, so the above exclusion may not apply to you.

The environment near a saltwater coast can be extremely corrosive. Some corrosion and/or deterioration is considered "normal wear" in this environment. Product installed within 500 yards of a saltwater shoreline will only be covered for half the period of the standard product warranty, up to a maximum of five years, for defects caused by corrosion. Products installed in direct contact with saltwater or that are subjected to salt spray are not covered by the standard warranty for any defects caused by corrosion.

Contact your local Burke Representative for warranty information regarding Burke Turf® and Burke Tile products.

Terms of Sale

Pricing: Prices published in this catalog are in USD, are approximate and do not include shipping & handling, surfacing, installation nor applicable taxes. All prices are subject to change without notice. Contact your Burke representative for current pricing. Payments are to be made in USD.

Weights: Weights are approximate and may vary with actual orders.

Installation: All equipment is shipped unassembled. For a list of factory-certified installers in your area, please contact your Burke representative.

Specifications: Product specifications in this catalog were correct at the time of publication. However, product improvements are ongoing at Burke, and we reserve the right to change or discontinue specifications without notice.

Loss or Damage in Transit: A signed bill of lading is our receipt from a carrier that our shipment to you was complete and in good condition upon arrival. Before you sign, please check the Bill of Lading carefully when the shipment arrives to make sure nothing is missing and there are no damages. Once the shipment leaves our plant, we are no longer responsible for any damage, loss or shortage.

For more information regarding the warranty, call Customer Service at 920-921-9220 or 1-800-356-2070.

01/2021

Option B

St. Croix Recreation Fun Playgrounds INC.

1826 Tower Dr W
Stillwater, MN 55082 US
16514301247
hannah@stcroixrec.com



Estimate

ESTIMATE # 6732

DATE 01/08/2024

EXPIRATION DATE 02/29/2024

ADDRESS

City of Ramsey
ALPINE PARK
PROPOSAL SCOPE B

SHIP TO

City of Ramsey
Attn: Parks Department
14100 Jasper St NW
Ramsey, MN 55303
ATTN: MARIAH
ALBRECHT

PLEASE DETACH TOP PORTION AND RETURN WITH YOUR PAYMENT.

SHIP VIA

TRUCKLOAD

SALES REP

MIKE BASICH

ACTIVITY	QTY	RATE	AMOUNT
BCI 100-178990-1 CUSTOM BURKE PLAY ENVIRONMENT INCLUDING ALL STRUCTURES AND COMPONENTS AS DEPICTED IN IMAGES, DRAWINGS AND MATERIALS LISTS IDENTIFIED AS PR#100-178990-1 ATTACHED. (PROPOSAL SCOPE B)	1	114,475.00	114,475.00
Freight Freight quotes currently only valid for 15 days. Quote based on information currently listed on estimate. Modifications to delivery address, contact or offloading capability must be made prior to order. If made after order is placed, surcharges may apply.	1	3,500.00	3,500.00
Concrete Curb 230 Linear Feet of 6" wide by 12" tall concrete curb rectangular on prepared grade- w/2 # 4 rebar continuous	1	10,750.00	10,750.00
ENGINEERED WOOD FIBER ENGINEERED WOOD FIBER 12" COMPACTED DEPTH	220	38.00	8,360.00
SF RUBBER RESILIENT 350 SQUARE FEET RUBBER PIP 50% BLACK 50% GREEN AT SWINGS, SLIDE EXITS	1	11,200.00	11,200.00
INSTALLATION *Please reference project manager/installer directly for specific scope of work, and/or additional information found in email correspondence, proposals, and estimates.	1	32,000.00	32,000.00
APPLIED DISCOUNT ADDITIONAL MFG. DISCOUNT APPLIED	1	-30,285.00	-30,285.00

MATERIAL ITEMS AS QUOTED ARE GOOD FOR 30 DAYS. FREIGHT QUOTES ARE GOOD FOR 15 DUE TO FUEL UNCERTAINTIES. SALES TAX SUBJECT TO CHANGE. ADD IF NOT TAX EXEMPT OR SUPPLY EXEMPTION CERTIFICATE IF NOT ON FILE. PAYMENT TERMS ARE NET 30 DAYS UNLESS OTHERWISE NOTED. FAILURE TO PAY IN A TIMELY MANNER WILL BE SUBJECT TO INTEREST AT A RATE OF 1.5%/MONTH OR 18% ANNUALLY.

TOTAL

\$150,000.00

By signing estimate or authorizing by email or PO, purchaser is agreeing to billing terms as listed on the estimate. Order to include model number(s), quantity and color(s) above including any supplemental documents provided and/or requested. Please verify all content for accuracy. **Those purchasing off of the MN State Contract are bound only by the terms and conditions listed in said contract**

*LEAD TIMES AND SHIPPING DATES ARE BASED ON CURRENT INVENTORY. PLEASE BE PATIENT AS OUR VENDORS NAVIGATE SUPPLY CHAINS & NATIONAL SHORTAGES.

**FOR BIDDING CONTRACTORS & SUPPLIERS: ST CROIX RECREATION IS NOT LIABLE FOR INTERPRETATION OF PROJECT BIDS, DRAWINGS OR ADDENDA. IT IS THE CUSTOMER'S RESPONSIBILITY TO VERIFY ACCURACY OF MODEL NUMBER(S), DESCRIPTION(S), QUANTITY AND COLOR(S) DIRECTLY WITH END USER

Accepted By

Accepted Date

By signing estimate or authorizing by email or PO, purchaser is agreeing to billing terms as listed on the estimate. Order to include model number(s), quantity and color(s) above including any supplemental documents provided and/or requested. Please verify all content for accuracy. **Those purchasing off of the MN State Contract are bound only by the terms and conditions listed in said contract**

Option B

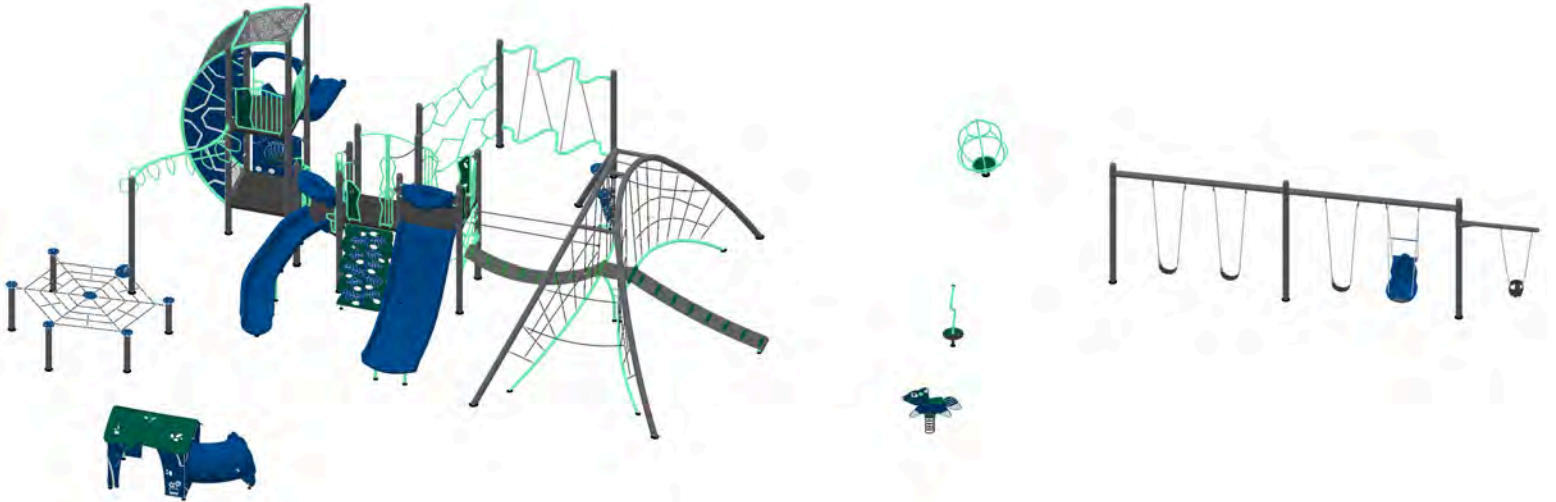

St. Croix Recreation Fun Playgrounds Inc.

1826 Tower Dr W | Stillwater, MN 55082 | 651-430-1247

Proposal 100-178990-1 | 1/5/2024

OUR MISSION IS TO BRING
PLAY THAT MOVES YOU[®]
TO COMMUNITIES AROUND
THE WORLD

6600 Alpine Dr, Ramsey, MN, 55303 | Ramsey, MN 55303

January 05, 2024

Mariah Albrecht
City of Ramsey Parks Department
7550 Sunwood Dr. NW
Ramsey, MN 55303
Phone: 763-433-9820

Dear Mariah Albrecht:

St. Croix Recreation Fun Playgrounds Inc. is delighted to provide City of Ramsey Parks Department with this playground equipment proposal.

This design was developed with your specific needs in mind, and we look forward to discussing this project further with you to ensure your complete satisfaction. St. Croix Recreation Fun Playgrounds Inc. is confident that this proposal will satisfy City of Ramsey Parks Department's functional, environmental, and safety requirements -- and most importantly -- bring joy and excitement to the children and families directly benefiting from your new playground.

You have our personal commitment to support this project and your organization in every manner possible, and we look forward to developing a long-standing relationship with City of Ramsey Parks Department. We appreciate your consideration and value this opportunity to earn your business.

Sincerely,

Mike Basich
Sales Representative

St. Croix Recreation Fun Playgrounds Inc.
1826 Tower Dr W
Stillwater, MN 55082
www.funplaygrounds.com
www.bciburke.com

Phone: 651-430-1247
Fax: -
mb@stcroixrec.com

OUR MISSION IS TO BRING
PLAY THAT MOVES YOU[®]
TO COMMUNITIES AROUND
THE WORLD

COOPERATIVE PURCHASING OPTIONS

PLAYGROUNDS WITHOUT ALL THE PAPERWORK

Purchasing with contracts may sound intimidating, but getting your community playspace doesn't need to be a painful process of writing specifications, issuing RFP's and jumping through hoops – it can be simplified – we promise! As you continue planning for your new playground, review the Purchasing Contracts offered through our partners.

EQUALIS GROUP

Equalis is an innovative cooperative purchasing organization that believes in the power of partnership and that when you work together you achieve more. The basic premise of the Equalis cooperative purchasing organization is to leverage the combined buying power of all members for better pricing and favorable contract terms. Equalis Group uses the lead agency model for competitively bid contracts, provides our participants the savings they expect and offers efficiencies and peace of mind within the procurement process. It is our mission to continuously improve the measurable and meaningful impact of cooperative services for everyone throughout the supply chain.

GOVMVMT

GOVMVMT is a non-profit group purchasing organization that meets the highest industry standards while putting the public's interest at the forefront of everything they do. Each one of GOVMVMT's first-class suppliers has consciously joined their mission to create the most credible, ethical, and public agency-focused non-profit cooperative purchasing program in the country.

GSA

Federal parks, child development programs, military bases and other agencies are a major priority for BCI Burke, and agencies can purchase Burke playgrounds through Burke's GSA contract for installation virtually anywhere in the world.

OMNIA PARTNERS

OMNIA Partners, Public Sector (Subsidiary National IPA) is the largest and most experienced organization in purchasing and supply chain management. Comprised of participants and suppliers in the public sector, we bring together industry-leading buying power and world-class suppliers to offer an extensive portfolio of competitively solicited and publicly awarded contracts and partnerships. OMNIA Partners is proud to offer more value and resources to state and local government, higher education, K-12 education and non-profits.

SOURCEWELL

As a leader in cooperative purchasing, Sourcewell is passionate about helping members fulfill their public service missions. Sourcewell builds strong relationships with members and vendors to develop practical solutions together.

The easiest way to Join Our Movement is to call your local Representative at 800.266.1250 or visit bciburke.com/rep. Our passion is bringing play to communities like yours and we can't wait to help you get started!



DESIGN SUMMARY

St. Croix Recreation Fun Playgrounds Inc. is very pleased to present this Proposal for consideration for the Ramsey Alpine Park Option 2 located in Ramsey. BCI Burke Company, LLC has been providing recreational playground equipment for over 100 years and has developed the right mix of world-class capabilities to meet the initial and continuing needs of City of Ramsey Parks Department. We believe our proposal will meet or exceed your project's requirements and will deliver the greatest value to you.

The following is a summary of some of the key elements of our Proposal:

- Project Name: Ramsey Alpine Park Option 2
- Project Number: 100-178990-1
- User Capacity: 154
- Age Groups: 5 to 12
- Dimensions: 87' 2"x90' 1"
- Designer Name: Leah Kirssin

St. Croix Recreation Fun Playgrounds Inc. has developed a custom playground configuration based on the requirements as they have been presented for the Ramsey Alpine Park Option 2 playground project. Our custom design will provide a safe and affordable playground environment that is aesthetically pleasing, full of fun for all users and uniquely satisfies your specific requirements. In addition, proposal # 100-178990-1 has been designed with a focus on safety, and is fully compliant with ASTM F1487 and CPSC playground safety standards.

We invite you to review this proposal for the Ramsey Alpine Park Option 2 playground project and to contact us with any questions that you may have.

Thank you in advance for giving us the opportunity to make this project a success.

Option B

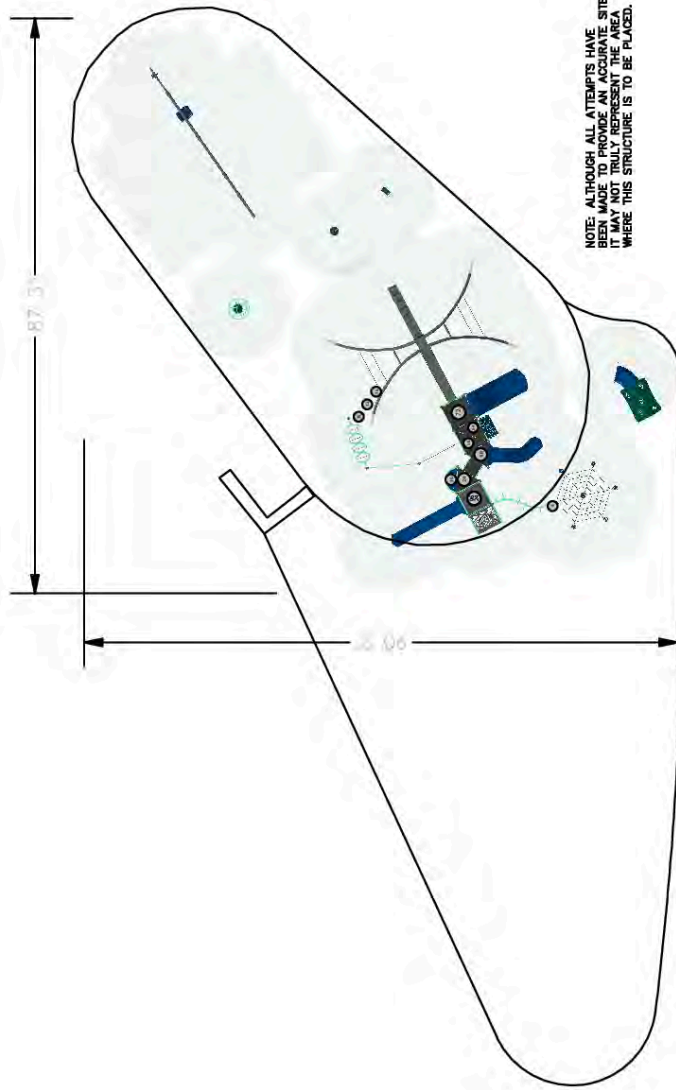

NOTE: ALTHOUGH ALL ATTEMPTS HAVE BEEN MADE TO PROVIDE AN ACCURATE SITE PLAN, THE CLIENT IS ADVISED THAT WHERE THIS STRUCTURE IS TO BE PLACED.

The use and layout of play components identified in this plan conform to the CPSC guidelines. U.S. CPSC recommends the separation of age groups in playground layouts.

TOTAL EVENTS	PLAYGROUND ACCESSIBILITY (Provided/Required)			TYPES OF GROUND EVENTS
	ELEVATED EVENTS	TRANSFER ACCESSIBLE EVENTS	RAMP ACCESSIBLE EVENTS	
28	10 / 5	10 / 0	0 / 0	20 / 3
				8 / 3

**The space requirements shown here are to ASTM standards. Requirements for other standards may be different.

OVERALL BOUNDING OF USE ZONES
 Area: 7855.2 sq. ft.
 Perimeter: 354.6 ft.
STRUCTURE SIZE: 90' 2" x 87' 3"
POST SIZE(S): 5"

Warning: Accessible safety surfacing material is required beneath and around this equipment that is compliant with ASTM, CPSC, and ADAAG requirements.

SERIES LINE: Nucleus | Intensity | Burke Basics

SITE PLAN VIEW

GROUP:
Structure | Free Standing

Ramsey Alpine Park Option 2

01/05/2024

Ramsey, MN 55303

St. Croix Recreation Fun Playgrounds

DESIGNED FOR AGES:
5 to 12

Burke
PLAY THAT MOVES YOU.

100-178990-1

Designer: Leah Kirssin

Option B

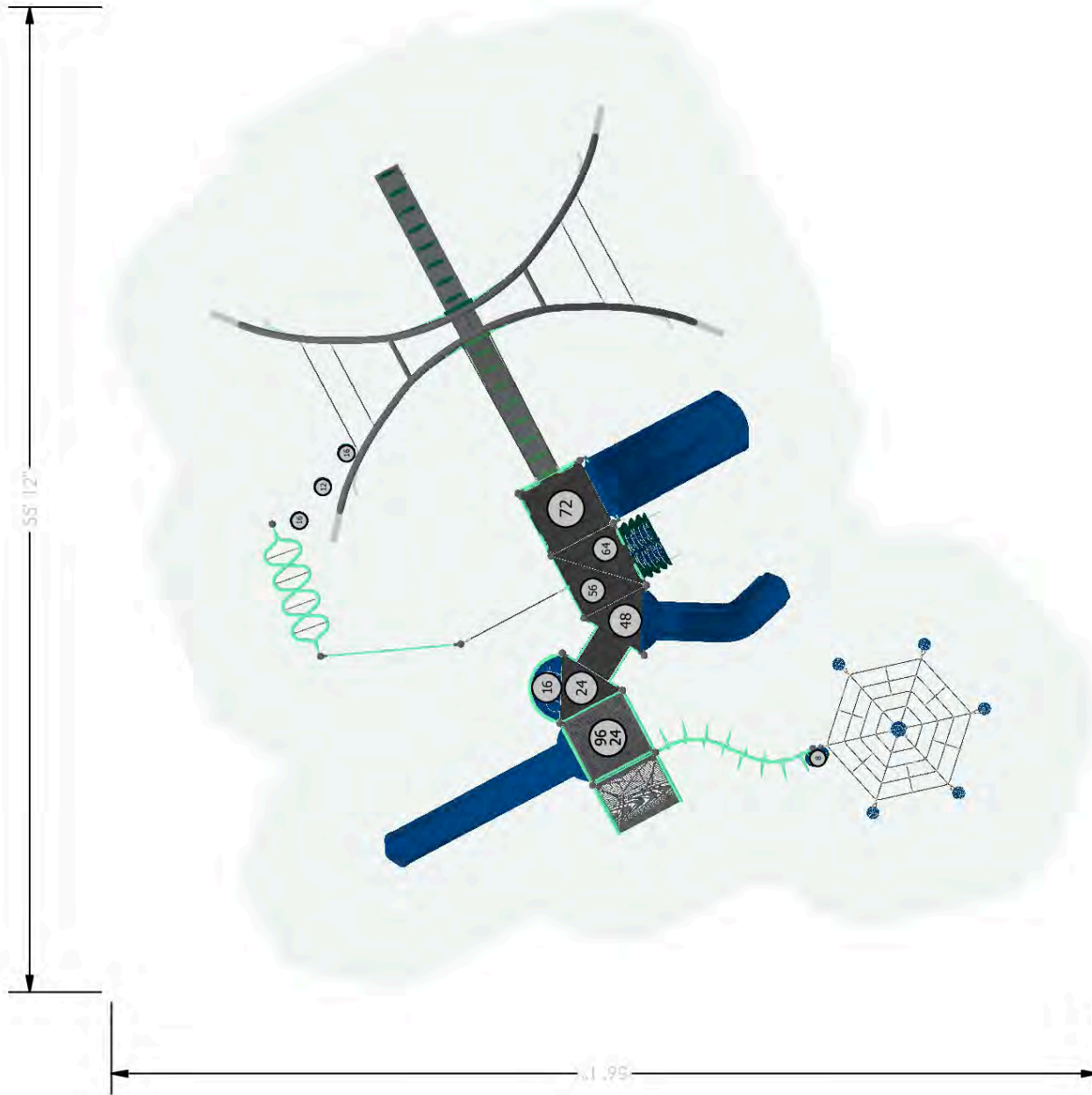

The use and layout of play components identified in this plan conform to the CPSC guidelines. U.S. CPSC recommends the separation of age groups in playground layouts.

TOTAL EVENTS	PLAYGROUND ACCESSIBILITY (Provided/Required)			TYPES OF GROUND EVENTS
	ELEVATED EVENTS	TRANSFER ACCESSIBLE EVENTS	RAMP ACCESSIBLE EVENTS	
28	10 / 5	10 / 0	0 / 0	20 / 3
				8 / 3

OVERALL BOUNDING OF USE ZONES
 Area: 7855.2 sq. ft.
 Perimeter: 354.6 ft.
STRUCTURE SIZE: 90' 2" x 87' 3"
POST SIZE(S): 5"

**The space requirements shown here are to ASTM standards. Requirements for other standards may be different.

Warning: Accessible safety surfacing material is required beneath and around this equipment that is compliant with ASTM, CPSC, and ADAAG requirements.

SERIES LINE: Nucleus | Intensity | Burke Basics

SITE PLAN VIEW

GROUP:
Structure

Ramsey Alpine Park Option 2

01/05/2024

Ramsey, MN 55303

St. Croix Recreation Fun Playgrounds

DESIGNED FOR AGES:
5 to 12

Burke
PLAY THAT MOVES YOU.

100-176990-1

Designer: Leah Kirssin

Option B

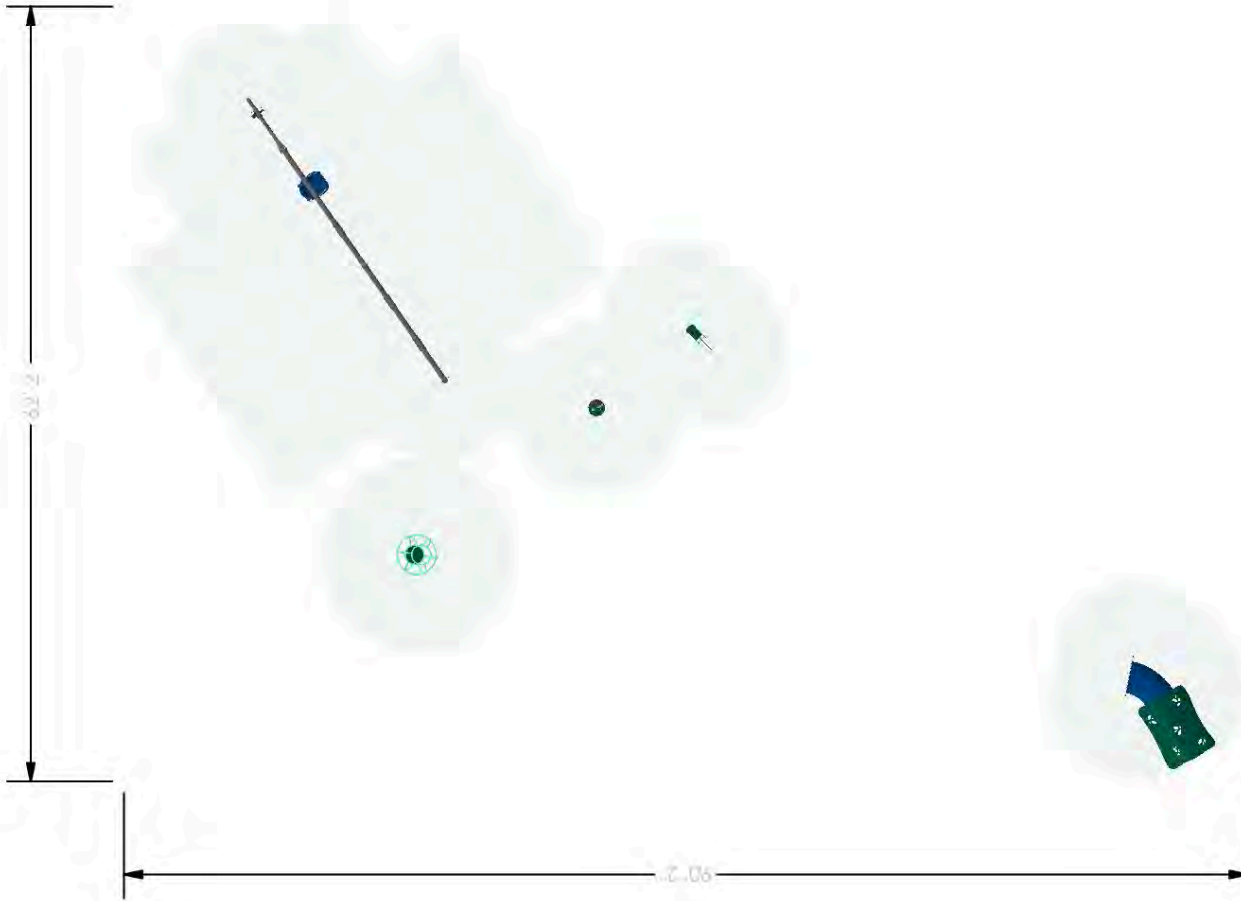

The use and layout of play components identified in this plan conform to the CPSC guidelines. U.S. CPSC recommends the separation of age groups in playground layouts.

TOTAL EVENTS	PLAYGROUND ACCESSIBILITY (Provided/Required)			TYPES OF GROUND EVENTS
	ELEVATED EVENTS	TRANSFER ACCESSIBLE EVENTS	RAMP ACCESSIBLE EVENTS	
28	10 / 5	10 / 0	0 / 0	20 / 3
				8 / 3

**The space requirements shown here are to ASTM standards. Requirements for other standards may be different.

OVERALL BOUNDING OF USE ZONES
 Area: 7855.2 sq.ft.
 Perimeter: 354.6 ft.
STRUCTURE SIZE: 90' 2" x 87' 3"
POST SIZE(S): 5"

SERIES LINE: Burke Basics

SITE PLAN VIEW

GROUP:
Free Standing

Ramsey Alpine Park Option 2

01/05/2024

Ramsey, MN 55303

St. Croix Recreation Fun Playgrounds

DESIGNED FOR AGES:
5 to 12



100-178990-1

Designer: Leah Kirssin

Warning: Accessible safety surfacing material is required beneath and around this equipment that is compliant with ASTM, CPSC, and ADAAG requirements.

Option B

ITEM	COMP.	DESCRIPTION
1	270-0129	TRIANGLE PLATFORM
2	470-0075	CRESCENT PLATFORM
3	270-0009	8" CLOSURE PLATE, ELLIPSE
4	270-0130	SQUARE PLATFORM
5	370-1679	S OVERHEAD, NUCLEUS
6	370-0814	WOBBLY WEB NET
7	670-0412	WOBBLY WEB POST, MED
8	670-0411	WOBBLY WEB POST, TALL
9	670-0413	WOBBLY WEB POST, SHORT
10	370-1608	OVISTEP LAUNCH PAD
11	570-1858	3-IN-A-ROW PANEL, ABOVE PLATFORM
12	470-0758	VELO XL SLIDE, 88"-96" W/O HOOD
13	470-0967	SLIDE HOOD, LOW SIDE WALL
14	370-1649	EVOLUTION, DECK TO ROOF CLIMBER
15	570-0100	EVOLUTION BARRIER
16	470-0015	EVOLUTION SQUARE ROOF
17	470-0008	EVOLUTION SIDE ROOF SUPPORT, LEFT
18	470-0003	EVOLUTION TOP ROOF SUPPORT, SINGLE
19	470-0009	EVOLUTION SIDE ROOF SUPPORT, RIGHT
20	370-0039	EVOLUTION 24" TRANSITION STAIR W/ BARRIERS
21	470-0660	VIPER L 48-56 W/O HOOD
22	470-0805	SLIDE HOOD, HIGH SIDE WALL
23	270-0301	SPLIT SQUARE PLATFORMCLOSURE PLATE
24	470-0803	CONTOUR SLIDE, 64"-72"
25	370-1634	LEVEL X LINK
26	270-0120	EVOLUTION UNITARY ENCLOSURE
27	560-2613	LEVEL X ALLY CENTER
28	560-2605	LEVEL X GROUND LINK
29	370-0865	TREE BRANCH CLIMBER 72"
30	370-0197	TRANGO TWO CLIMBER
31	270-0292	EVOLUTION CENTER MOUNT ENCLOSURE
32	370-0804	JUNGLE VINE CLIMBER 64"
33	370-0033	ODYSSEY POST LINK DOUBLE
34	370-0808	TWISTING TRAVERSE
35	560-0453	STEP SPOT POD 8-16"

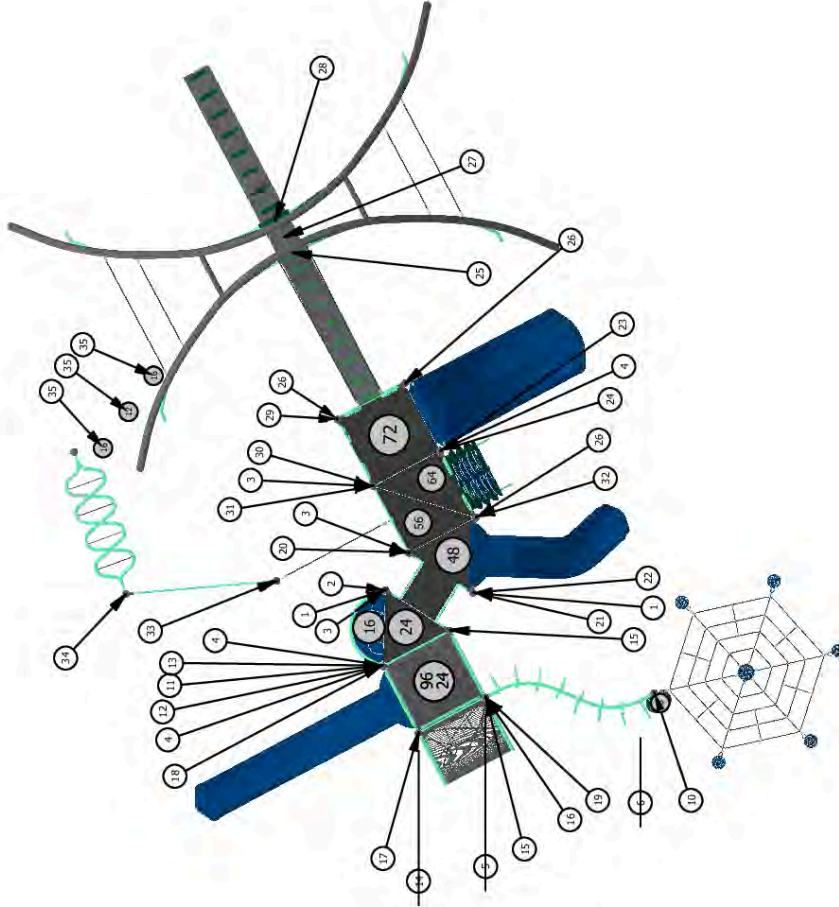

SERIES LINE: Nucleus | Intensity | Burke Basics

COMPONENT VIEW

GROUP:
Structure

Ramsey Alpine Park Option 2

01/05/2024

Ramsey, MN 55303

St. Croix Recreation Fun Playgrounds

DESIGNED FOR AGES:
5 to 12

100-178990-1

Burke
PLAY THAT MOVES YOU

Designer: Leah Kirssin

Option B

ITEM	COMP.	DESCRIPTION
1	550-0201	SINGLE POST SWING ASSEMBLY 5" OD
2	550-0202	SINGLE POST SWING ADD-ON 5" OD
3	550-0183	TOT BAY, ADD-ON, GALV CHAIN
4	550-0111	BELT SEAT, 8' SINGLE, STD CHAIN
5	550-0171	FREEDOM SWING SEAT, 8' BEAM, STD CHAIN
6	560-2586	COMET 1
7	570-2692	RACCOON ROCKER
8	580-1376	PLAYHOUSE WITH TUNNEL
9	560-0457	SWIFT TWIST SPINNER

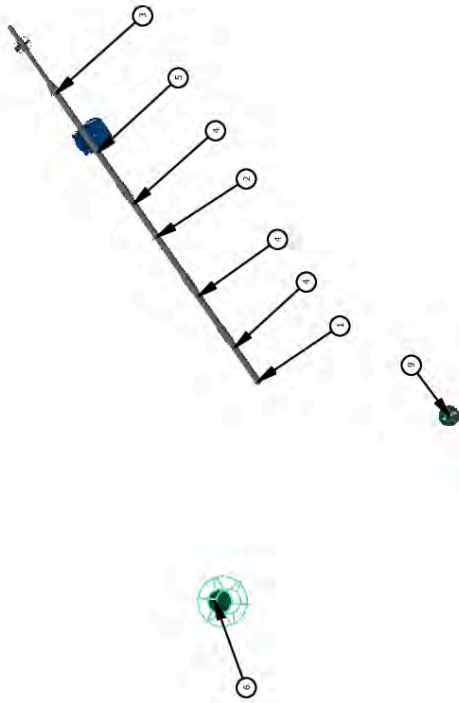

SERIES LINE: Burke Basics

COMPONENT VIEW

GROUP:
Free Standing

Ramsey Alpine Park Option 2
Ramsey, MN 55303

01/05/2024

DESIGNED FOR AGES:
5 to 12

St. Croix Recreation Fun Playgrounds
100-178990-1



Designer: Leah Kirssin

Option B

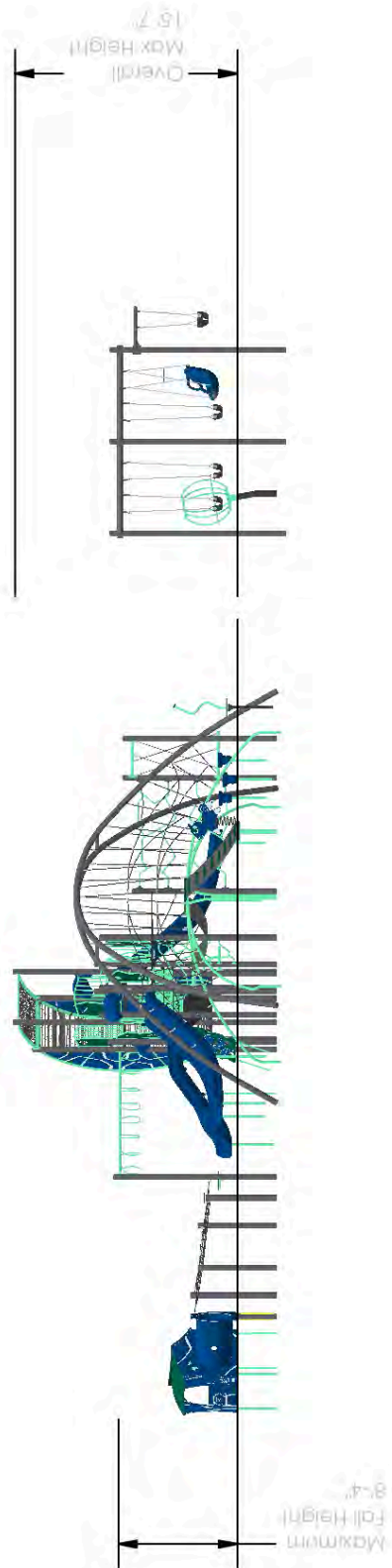

SERIES LINE: Nucleus | Intensity | Burke Basics

ELEVATION VIEW

GROUP:
Structure | Free Standing

Ramsey Alpine Park Option 2

01/05/2024

Ramsey, MN 55303

St. Croix Recreation Fun Playgrounds

DESIGNED FOR AGES:
5 to 12

Burke
PLAY THAT MOVES YOU

100-178990-1

Designer: Leah Kirssin

Option B

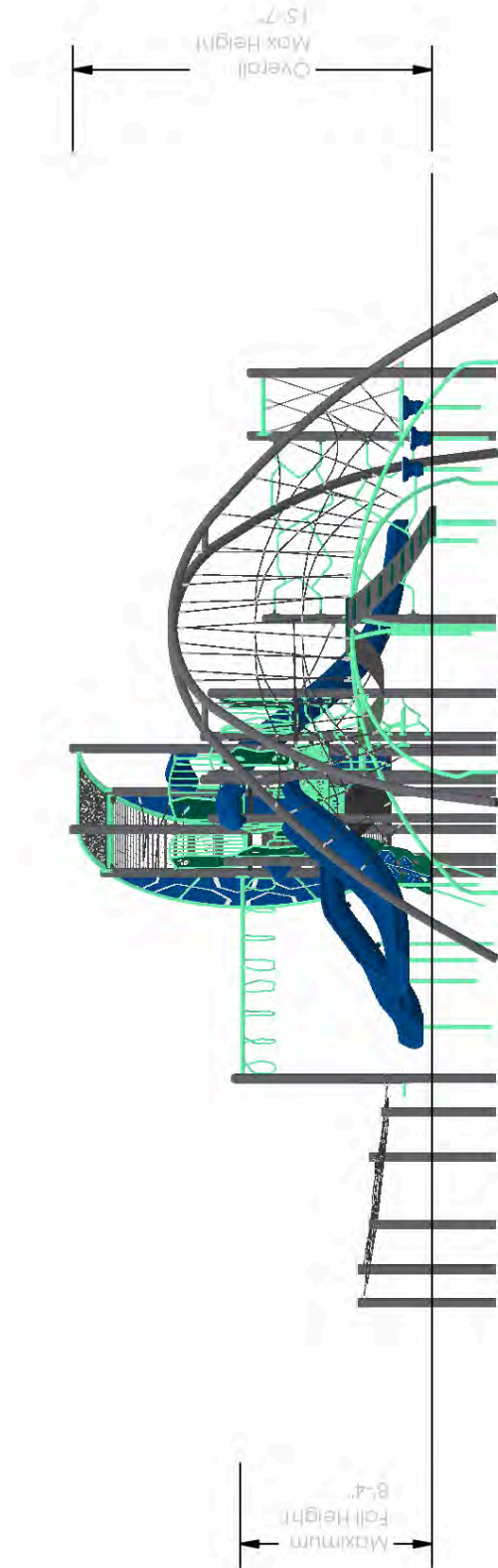

SERIES LINE: Nucleus | Intensity | Burke Basics

ELEVATION VIEW

GROUP:
Structure

Ramsey Alpine Park Option 2

Ramsey, MN 55303

01/05/2024

DESIGNED FOR AGES:
5 to 12

St. Croix Recreation Fun Playgrounds
100-178990-1

Designer: Leah Kirssin

Burke
PLAY THAT MOVES YOU

Option B

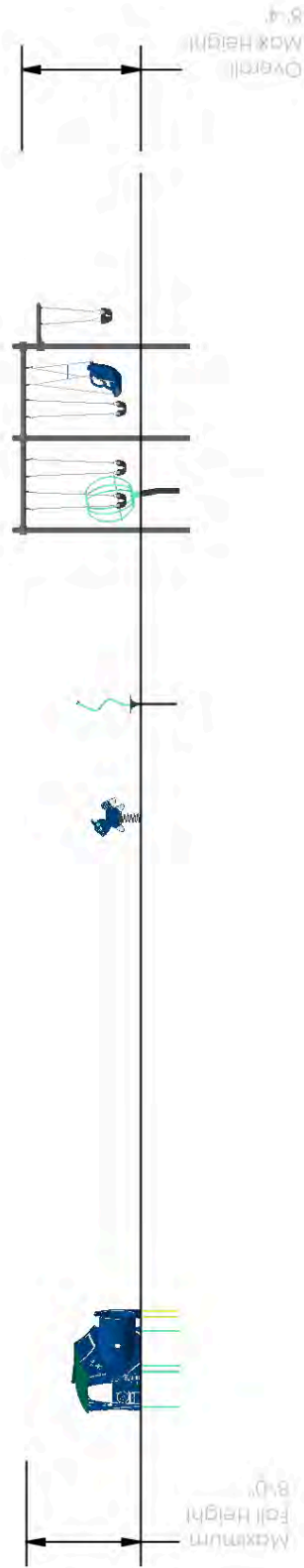

SERIES LINE: Burke Basics

ELEVATION VIEW

GROUP:
Free Standing

Ramsey Alpine Park Option 2

01/05/2024

Ramsey, MN 55303

St. Croix Recreation Fun Playgrounds

DESIGNED FOR AGES:
5 to 12

Burke
PLAY THAT MOVES YOU

100-178990-1

Designer: Leah Kirssin

Option B

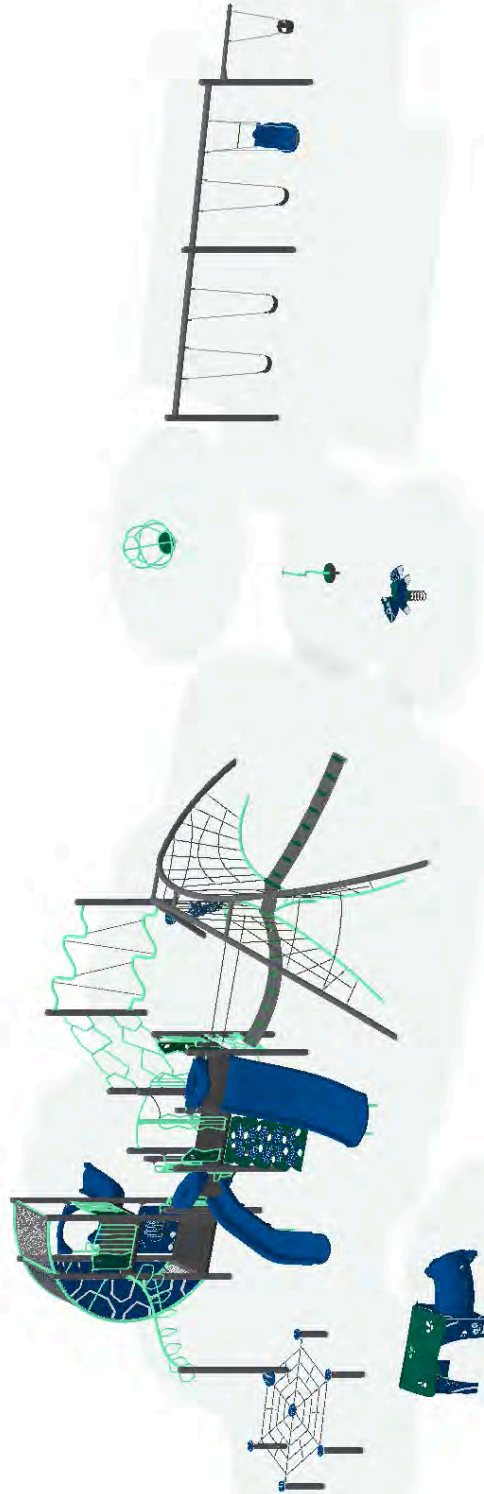

SERIES LINE: Nucleus | Intensity | Burke Basics

ISOMETRIC VIEW

GROUP:
Structure | Free Standing

Ramsey Alpine Park Option 2

Ramsey, MN 55303

01/05/2024

DESIGNED FOR AGES:
5 to 12

St. Croix Recreation Fun Playgrounds
100-178990-1

Designer: Leah Kirssin

Burke
PLAY THAT MOVES YOU

Option B

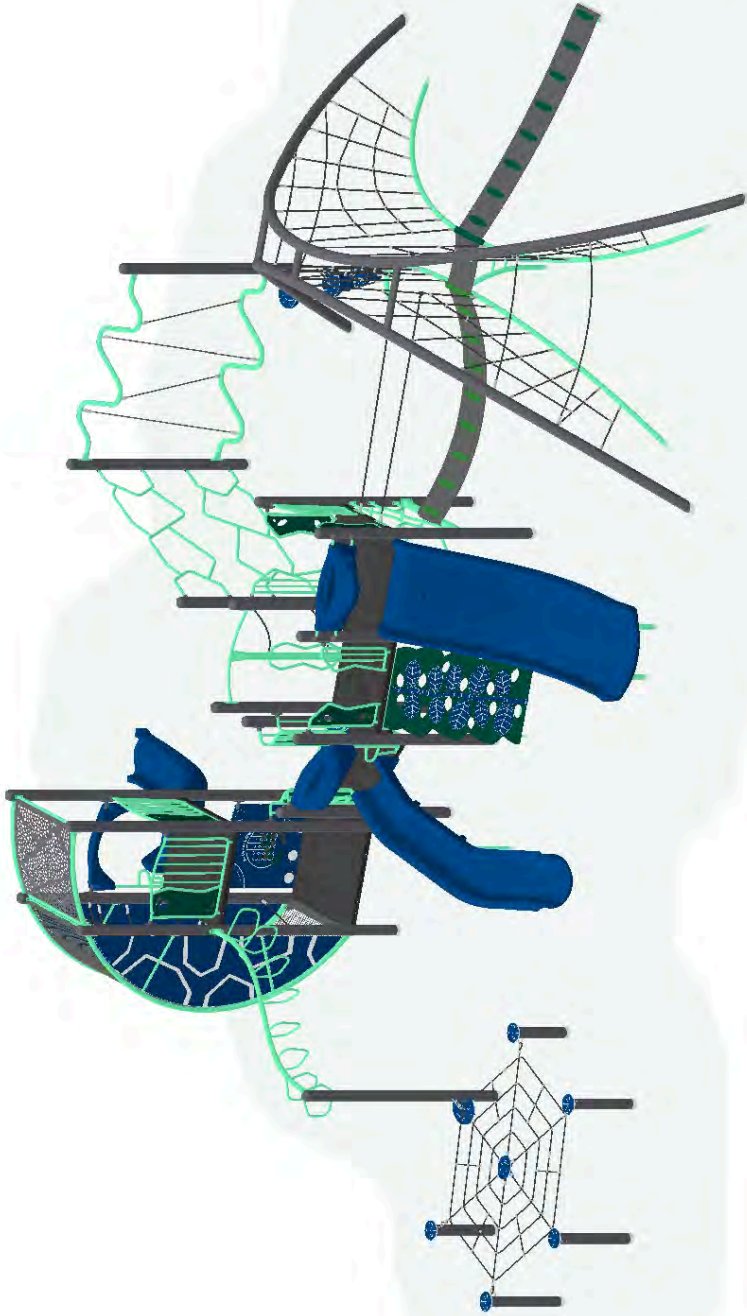

SERIES LINE: Nucleus | Intensity | Burke Basics

ISOMETRIC VIEW

GROUP:
Structure

Ramsey Alpine Park Option 2

Ramsey, MN 55303

01/05/2024

DESIGNED FOR AGES:
5 to 12

St. Croix Recreation Fun Playgrounds
100-178990-1

Designer: Leah Kirssin

Burke
PLAY THAT MOVES YOU

Option B

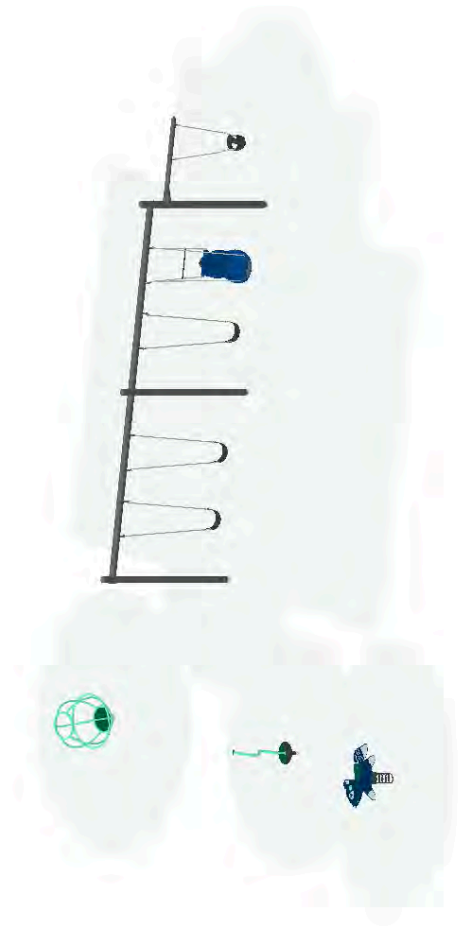

SERIES LINE: Burke Basics

ISOMETRIC VIEW

GROUP:
Free Standing

Ramsey Alpine Park Option 2
Ramsey, MN 55303

01/05/2024

DESIGNED FOR AGES:
5 to 12

St. Croix Recreation Fun Playgrounds
100-178990-1

Designer: Leah Kirssin

Burke
PLAY THAT MOVES YOU

The play components identified in this proposal are IPEMA certified. The use and layout of these components conform to the requirements of ASTM F1487. To verify product certification, visit www.ipema.org.



The space requirements shown in this proposal are to ASTM standards. Requirements for other standards may be different.

Component No.	Description	Qty	User Cap	Ext. User Cap	Weight	Ext. Weight
Structure						
Nucleus						
072-0500-116C	5" OD X 116" CAPPED POST	1	0	0	61	61
072-0500-120C	5" OD X 120" CAPPED POST	1	0	0	63	63
072-0500-124C	5" OD X 124" CAPPED POST	1	0	0	65	65
072-0500-128C	5" OD X 128" CAPPED POST	2	0	0	67	134
072-0500-136C	5" OD X 136" CAPPED POST	1	0	0	71	71
072-0500-140C	5" OD X 140" CAPPED POST	1	0	0	74	74
072-0500-148C	5" OD X 148" CAPPED POST	3	0	0	78	234
072-0500-152C	5" OD X 152" CAPPED POST	2	0	0	80	160
072-0500-204C	5" OD X 204" CAPPED POST	2	0	0	107	214
072-0500-220C	5" OD X 220" CAPPED POST	2	0	0	115	230
270-0009	8" CLOSURE PLATE, ELLIPSE	3	0	0	8	24
270-0120	EVOLUTION UNITARY ENCLOSURE	3	0	0	34	102
270-0129	TRIANGLE PLATFORM	2	2	4	48	96
270-0130	SQUARE PLATFORM	3	6	18	106	318
270-0292	EVOLUTION CENTER MOUNT ENCLOSURE	1	0	0	40	40
270-0301	SPLIT SQUARE PLATFORMCLOSURE ...	1	4	4	108	108
370-0039	EVOLUTION 24" TRANSITION STAI...	1	4	4	181	181
370-0197	TRANGO TWO CLIMBER	1	5	5	12	12
370-0804	JUNGLE VINE CLIMBER 64"	1	2	2	111	111
370-0865	TREE BRANCH CLIMBER 72"	1	4	4	33	33
370-1649	EVOLUTION, DECK TO ROOF CLIMBER	1	7	7	472	472
470-0003	EVOLUTION TOP ROOF SUPPORT, S...	1	0	0	13	13
470-0008	EVOLUTION SIDE ROOF SUPPORT, ...	1	0	0	18	18
470-0009	EVOLUTION SIDE ROOF SUPPORT, ...	1	0	0	18	18
470-0015	EVOLUTION SQUARE ROOF	1	0	0	42	42
470-0075	CRESCENT PLATFORM	1	1	1	52	52
470-0660	VIPER L 48-56 W/O HOOD	1	2	2	126	126
470-0758	VELO XL SLIDE, 88"-96" W/O HOOD	1	2	2	134	134
470-0803	CONTOUR SLIDE, 64"-72"	1	4	4	232	232
470-0805	SLIDE HOOD, HIGH SIDE WALL	1	0	0	32	32
470-0967	SLIDE HOOD, LOW SIDE WALL	1	0	0	37	37
570-0100	EVOLUTION BARRIER	2	0	0	52	104
570-1858	3-IN-A-ROW PANEL, ABOVE PLATFORM	1	2	2	45	45
600-0104	NPPS SUPERVISION SAFETY KIT	1	0	0	3	3
660-0103	MAINTENANCE KIT, STRUCTURE	1	0	0	7	7
660-0104	INSTALLATION KIT, STRUCTURE	1	0	0	5	5

Intensity

370-0033	ODYSSEY POST LINK DOUBLE	1	4	4	78	78
370-0808	TWISTING TRAVERSE	1	5	5	103	103
370-0814	WOBBLY WEB NET	1	10	10	36	36
370-1608	OVISTEP LAUNCH PAD	1	1	1	10	10
370-1679	S OVERHEAD, NUCLEUS	1	7	7	59	59
670-0411	WOBBLY WEB POST, TALL	2	0	0	59	118
670-0412	WOBBLY WEB POST, MED	2	0	0	55	110
670-0413	WOBBLY WEB POST, SHORT	1	0	0	50	50

Structure**Burke Basics**

370-1634	LEVEL X LINK	1	2	2	45	45
560-0453	STEP SPOT POD 8-16"	3	1	3	19	57
560-2605	LEVEL X GROUND LINK	1	1	1	9	9
560-2613	LEVEL X ALLY CENTER	1	41	41	1124	1124

Total User Capacity: 133
Total Weight: 5470 lbs.
Total Price: \$96,179

Free Standing**Burke Basics**

550-0111	BELT SEAT, 8' SINGLE, STD CHAIN	3	1	3	10	30
550-0171	FREEDOM SWING SEAT, 8' BEAM, ...	1	1	1	38	38
550-0183	TOT BAY, ADD-ON, GALV CHAIN	1	1	1	51	51
550-0201	SINGLE POST SWING ASSEMBLY 5" OD	1	0	0	220	220
550-0202	SINGLE POST SWING ADD-ON 5" OD	1	0	0	145	145
560-0457	SWIFT TWIST SPINNER	1	1	1	52	52
560-2586	COMET I	1	6	6	154	154
570-2692	RACCOON ROCKER	1	1	1	65	65
580-1376	PLAYHOUSE WITH TUNNEL	1	8	8	400	400
660-0101	INSTALL KIT, BURKE BASICS - P...	1	0	0	2	2

Total User Capacity: 21
Total Weight: 1157 lbs.
Total Price: \$18,296

Special Notes:

Prices do not include freight, unloading, material storage, site excavation/preparation, removal of existing equipment, removal of excess soil from footing holes, site security, safety surfacing, installation, or sales tax (if applicable). Prices are based on standard colors per CURRENT YEAR BCI Burke Catalog. Custom colors, where available, would be an extra charge. **Pricing is valid for 30 days from the date of this proposal.**

Option B

COLOR SELECTION LIST | PlaygroundColorOption:1

GROUP 1 (Structure)

Deck: Gray
Post: Charcoal
Panel: Blue-White-Blue
Acc: Mint
Flat: Green
Plastic: Blue

GROUP 2 (Free Standing)

Post: Charcoal
Deck: Gray
Plastic: Blue
Flat: Green
Acc: Mint
Panel: Gray-Black-Gray | Blue-White-Blue

COLORS THAT MOVE YOU

POWDER COAT PAINT



SOLIS HUE TOPPERS

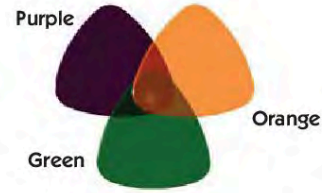

ROCKIT CLIMBERS

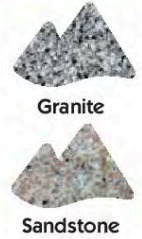

PLATFORMS



HDPE PLASTIC PANELS

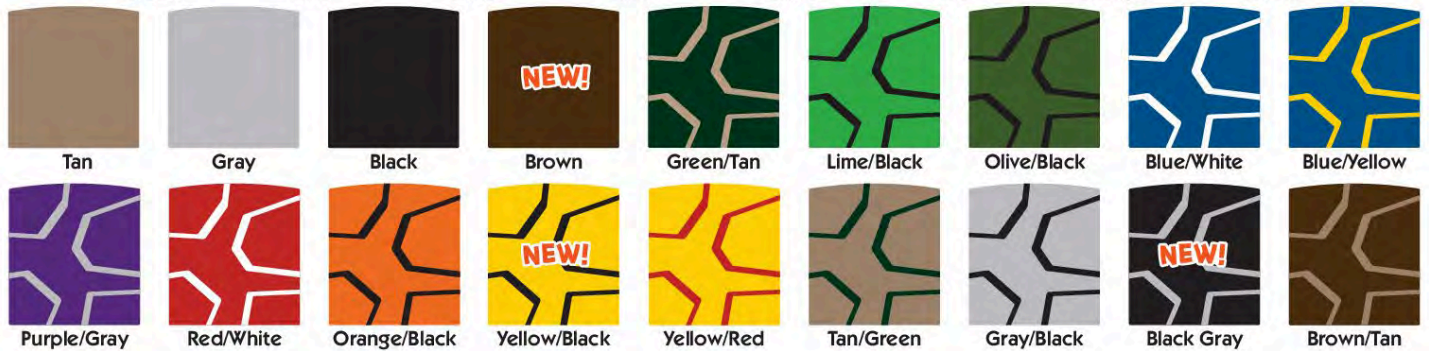
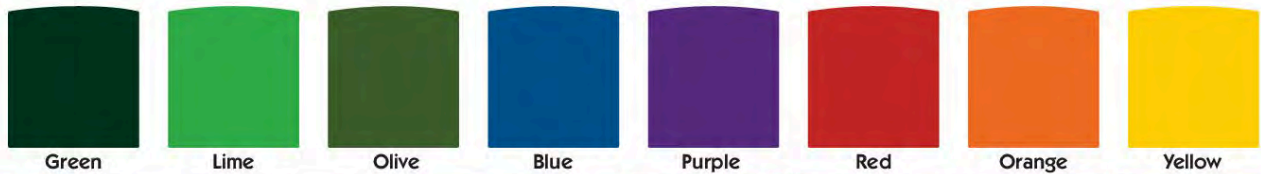

SHADE CANOPIES

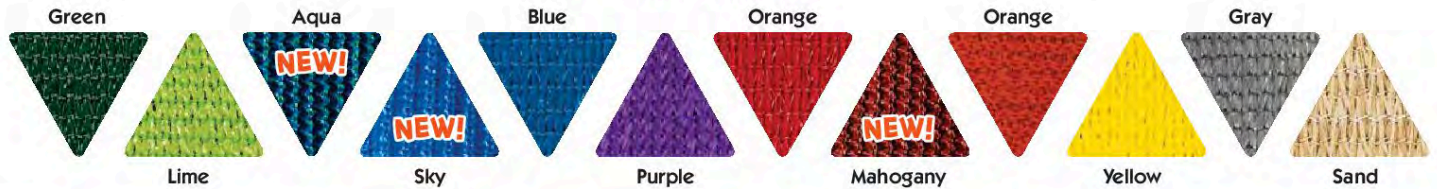

ROTOMOLD PLASTIC

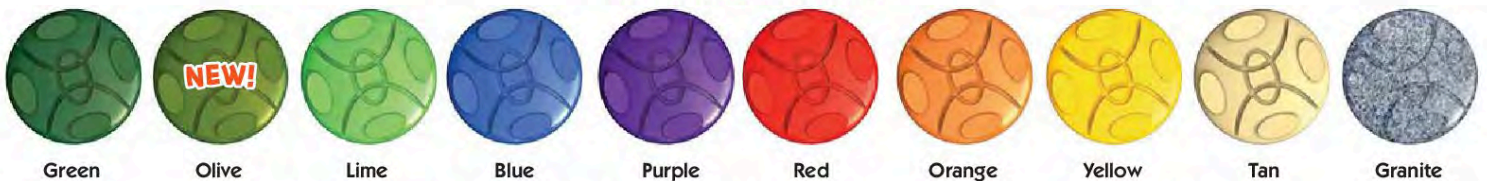

VISIT BCIBURKE.COM/COLOR TO CUSTOMIZE YOUR PLAYGROUND COLORS!

BURKE GENERATIONS WARRANTY®

The Longest and Strongest warranty in the industry

BCI Burke Company, LLC ("Burke") warrants that all standard products are warranted to be free from defects in materials and workmanship, under normal use and service, for a period of one (1) year from the date of shipment.

We stand behind our products. In addition, the following products are warranted, under normal use and service from the date of shipment as follows:

- One Hundred (100) Year Limited Warranty on aluminum and steel upright posts (including Intensity®, Synergy™, Nucleus®, Voltage®, Little Buddies®, ELEVATE®, ACTIVATE®, INVIGORATE™) against structural failure due to corrosion, deterioration or workmanship.
- One Hundred (100) Year Limited Warranty on KoreKonekt® clamps against structural failure due to corrosion, deterioration or workmanship.
- One Hundred (100) Year Limited Warranty on Hardware (nuts, bolts, washers)
- One Hundred (100) Year Limited Warranty on bolt-through fastening and clamp systems (Synergy™, Intensity®, Nucleus®, Voltage®, Little Buddies®, ELEVATE®).
- Twenty-Five (25) Year Limited Warranty on spring assemblies and aluminum cast animals.
- Fifteen (15) Year Limited Warranty on structure platforms and decks, metal roofs, table tops, bench tops, railings and barriers against structural failure due to materials or workmanship.
- Fifteen (15) Year Limited Warranty on all plastic components including StoneBorders against structural failure due to materials or workmanship.
- Ten (10) Year Limited Warranty on ShadePlay Canopies fabric, threads, and cables against degradation, cracking or material breakdown resulting from ultra-violet exposure, natural deterioration or manufacturing defects. This warranty is limited to the design loads as stated in the specifications.
- Ten (10) Year Limited Warranty on NaturePlay® Boulders and GFRC products against structural failure due to natural deterioration or workmanship. Natural wear, which may occur with any concrete product with age, is excluded from this warranty.
- Ten (10) Year Limited Warranty on Full Color Custom Signage against manufacturing defects that cause delamination or degradation of the sign. Full Color Custom Signs also carry a two (2) year warranty against premature fading of the print and graphics on the signs.
- Five (5) Year Limited Warranty on Intensity® and RopeVenture® cables and LEVEL X® flex bridge against premature wear due to natural deterioration or manufacturing defects. Determination of premature wear will be at the manufacturer's discretion.
- Five (5) Year Limited Warranty on moving parts, including swing components, against structural failure due to materials or workmanship.
- Five (5) Year Limited Warranty on PlayEnsemble® cables and mallets against defects in materials and workmanship.
- Three (3) Year Limited Warranty on electronic panel speakers, sound chips and circuit boards against electronic failure caused by manufacturing defects.

The warranty stated above is valid only if the equipment is erected in conformity with the layout plan and/or installation instructions furnished by BCI Burke Company, LLC using approved parts; have been maintained and inspected in accordance with BCI Burke Company, LLC instructions. Burke's liability and your exclusive remedy hereunder will be limited to repair or replacement of those parts found in Burke's reasonable judgment to be defective. Any claim made within the above stated warranty periods must be made promptly after discovery of the defect. A part is covered only for the original warranty period of the applicable part. Replacement parts carry the applicable warranty from the date of shipment of the replacement from Burke. After the expiration of the warranty period, you must pay for all parts, transportation and service charges.

Burke reserves the right to accept or reject any claim in whole or in part. Burke will not accept the return of any product without its prior written approval. Burke will assume transportation charges for shipment of the returned product if it is returned in strict compliance with Burke's written instructions.

THE FOREGOING WARRANTIES ARE EXCLUSIVE AND IN LIEU OF ANY OTHER WARRANTY, EXPRESS OR IMPLIED, INCLUDING BUT NOT LIMITED TO ANY IMPLIED WARRANTY OF MERCHANTABILITY OR FITNESS FOR A PARTICULAR PURPOSE. IF THE FOREGOING DISCLAIMER OF ADDITIONAL WARRANTIES IS NOT GIVEN FULL FORCE AND EFFECT, ANY RESULTING ADDITIONAL WARRANTY SHALL BE LIMITED IN DURATION TO THE EXPRESS WARRANTIES AND BE OTHERWISE SUBJECT TO AND LIMITED BY THE TERMS OF BURKE'S PRODUCT WARRANTY. SOME STATES DO NOT ALLOW THE EXCLUSION OF CERTAIN IMPLIED WARRANTIES, SO THE ABOVE LIMITATION MAY NOT APPLY TO YOU.

Warranty Exclusions: The above stated warranties do not cover: "cosmetic" defects, such as scratches, dents, marring, or fading; damage due to incorrect installation, vandalism, misuse, accident, wear and tear from normal use, exposure to extreme weather; immersion in salt or chlorine water, unauthorized repair or modification, abnormal use, lack of maintenance, or other cause not within Burke's control; and

Limitation of Remedies: Burke is not liable for consequential or incidental damages, including but not limited to labor costs or lost profits resulting from the use of or inability to use the products or from the products being incorporated in or becoming a component of any other product. If, after a reasonable number of repeated efforts, Burke is unable to repair or replace a defective or nonconforming product, Burke shall have the option to accept return of the product, or part thereof, if such does not substantially impair its value, and return the purchase price as the buyer's entire and exclusive remedy. Without limiting the generality of the foregoing, Burke will not be responsible for labor costs involved in the removal of products or the installation of replacement products. Some states do not allow the exclusion of incidental damages, so the above exclusion may not apply to you.

The environment near a saltwater coast can be extremely corrosive. Some corrosion and/or deterioration is considered "normal wear" in this environment. Product installed within 500 yards of a saltwater shoreline will only be covered for half the period of the standard product warranty, up to a maximum of five years, for defects caused by corrosion. Products installed in direct contact with saltwater or that are subjected to salt spray are not covered by the standard warranty for any defects caused by corrosion.

Contact your local Burke Representative for warranty information regarding Burke Turf® and Burke Tile products.

Terms of Sale

Pricing: Prices published in this catalog are in USD, are approximate and do not include shipping & handling, surfacing, installation nor applicable taxes. All prices are subject to change without notice. Contact your Burke representative for current pricing. Payments are to be made in USD.

Weights: Weights are approximate and may vary with actual orders.

Installation: All equipment is shipped unassembled. For a list of factory-certified installers in your area, please contact your Burke representative.

Specifications: Product specifications in this catalog were correct at the time of publication. However, product improvements are ongoing at Burke, and we reserve the right to change or discontinue specifications without notice.

Loss or Damage in Transit: A signed bill of lading is our receipt from a carrier that our shipment to you was complete and in good condition upon arrival. Before you sign, please check the Bill of Lading carefully when the shipment arrives to make sure nothing is missing and there are no damages. Once the shipment leaves our plant, we are no longer responsible for any damage, loss or shortage.

For more information regarding the warranty, call Customer Service at 920-921-9220 or 1-800-356-2070.

01/2021

MIDWEST PLAYSCAPES

Option A

Alpine Park - Scope A

Design Number: MW010524-1 - Bill Of Material

Ref. No.	Part No.	Description	Quantity
Posts			
1	ZZCH0028	3.5in OD x 136in STEEL POST W/ RIVETED CAP	5
2	ZZCH0068	3.5in OD x 184in STEEL POST POST W/RIVETED CAP	1
3	ZZCH0076	3.5in OD x 200in STEEL POST W/RIVETED CAP	6
4	ZZCH0256	3.5in OD x 212in STEEL POST W/CAP	2
5	ZZCH0891	FILLER POST- MIGHTY DESCENT SLIDE 96in DECK (CH)	1
Decks & Kick Plates			
6	ZZCH0616	SQUARE COATED DECK ASSEMBLY	2
7	zzCH0619	FULL HEX COATED DECK ASSEMBLY	1
ADA Items			
8	ZZCH2027	TRANSFER STATION W/BARRIERS (48in DECK)	1
9	ZZUN2019	APPROACH STEP FOR TRANSFER STATION	1
Slides			
10	ZZCH2696	GLIDE SLIDE (72in DECK)	1
11	ZZCH4696	MIGHTY DESCENT	1
Climbers			
12	ZZCH4706	VERTICLIMBER 96in	1
13	ZZCH6989	INCLINED CLIFF HANGER (72in DECK)	1
14	ZZCH7439	ROCK CLIMBER (48in DECK)	1
15	ZZCH7957	SILO CLIMBER (72in DECK)	1
16	ZZCH8280	HOPSCOTCH CLIMBER (72in DECK)	1
17	ZZCH8339	STEEL CURVE CLIMBER	1
Balance			
18	ZZUN7140	STATIONARY BUTTONS (12in)	2
19	ZZUN7146	STATIONARY BUTTONS (18in)	1
Audible Activities			
20	ZZCH4556	7in BELL (POST MOUNT)	1
Roofs & Arches			
21	ZZCH9887	CARNIVAL ROOF - SMALL PERF (HEX)	1
22	ZZCH9898	CARNIVAL ROOF HEX CAP	1
Stairs and Ladders			
23	ZZCH9170	24in ACCESS STEPPED PLATFORM (DECK TO DECK)	2
Additional Tool & Maintenance Kits			
24	ZZUN1471	INSTALLER HARDWARE KIT	1
25	ZZUN9910	SURFACING WARNING LABEL KIT	2
26	ZZUN9930	PIPE SYSTEMS MAINTENANCE KIT W/ AEROSOL	1
27	ZZUN9936	MAINTENANCE BOOK	1
28	ZZXXGNGUID	GENERAL INSTALLERS GUIDE	2



Alpine Park - Scope A

Option A

Design Number: MW010524-1 - Compliance and Technical Data

Reference Document: ASTM F1487

Ref. No.	Part No.	Qty.	Description	Unit ASTM Status	Total Weight (lbs)	Pre-Consumer Recycled Content (lbs)	Post-Consumer Content (lbs)	CO2e Footprint (kgs)	Users	Install Hours	Concrete (Yds3)	Active Play Events
1	ZZXX0065	1	SPIN CUP	Certified	57.21			301	1	2.00	0.12	1
2	ZZXX0260	2	BELT SEAT W/SILVER SHIELD CHAIN FOR 8ft TOP RAIL	Certified	17.60			108	2	0.50	0.00	2
3	ZZXX0265	1	INFANT SEAT W/SILVER SHIELD FOR 8ft TOP RAIL	Certified	11.31			90	1	0.25	0.00	1
4	ZZXX0483	1	COZY COCOON - SPINNING	Certified	132.00			834	3	1.50	0.13	1
5	ZZXX0818	1	8ft SINGLE POST SWING ASSEMBLY	N/A	257.68			159	0	2.00	0.24	0
6	ZZXX0819	1	8ft SINGLE POST SWING ADD-A-BAY	N/A	169.58			109	0	2.00	0.12	0
7	ZZXX0882	1	PLAYHOUSE	Certified	858.20			3,178	20	10.00	0.45	18
8	ZZXX0892	1	ACCESSIBLE SWING SEAT- 8ft TOP RAIL	Certified	51.90			639	1	0.50	0.00	1
9	ZZCH0028	5	3.5in OD x 136in STEEL POST W/ RIVETED CAP	Certified	217.55			293	0	5.00	0.63	0
10	ZZCH0068	1	3.5in OD x 184in STEEL POST POST W/RIVETED CAP	Certified	57.11			78	0	1.00	0.13	0
11	ZZCH0076	6	3.5in OD x 200in STEEL POST W/RIVETED CAP	Certified	366.06			503	0	6.00	0.75	0
12	ZZCH0256	2	3.5in OD x 212in STEEL POST W/CAP	Certified	124.02			187	0	2.00	0.26	0
13	ZZCH0891	1	FILLER POST- MIGHTY DESCENT SLIDE 96in DECK (CH)	N/A	44.50			13	0	0.75	0.13	0
14	ZZCH0616	2	SQUARE COATED DECK ASSEMBLY	Certified	109.72			348	6	2.00	0.00	0
15	zzCH0619	1	FULL HEX COATED DECK ASSEMBLY	Certified	151.26			444	6	1.50	0.00	0
16	ZZCH2027	1	TRANSFER STATION W/BARRIERS (48in DECK)	Certified	261.30			492	3	2.50	0.09	0
17	ZZUN2019	1	APPROACH STEP FOR TRANSFER STATION	Certified	35.83			72	1	1.00	0.04	0
18	ZZCH2696	1	GLIDE SLIDE (72in DECK)	Certified	151.63			653	2	1.50	0.03	1
19	ZZCH4696	1	MIGHTY DESCENT	Certified	748.80			1,285	8	7.00	0.18	1
20	ZZCH4706	1	VERTICLIMBER 96in	Certified	142.40			91	2	1.50	0.13	1
21	ZZCH6989	1	INCLINED CLIFF HANGER (72in DECK)	Certified	144.40			615	2	2.50	0.06	1
22	ZZCH7439	1	ROCK CLIMBER (48in DECK)	Certified	136.38			555	3	2.00	0.03	1
23	ZZCH7957	1	SILO CLIMBER (72in DECK)	Certified	82.32			144	1	1.50	0.06	1



Alpine Park - Scope A

Option A

Design Number: MW010524-1 - Compliance and Technical Data
 Reference Document: ASTM F1487

Ref. No.	Part No.	Qty.	Description	Unit ASTM Status	Total Weight (lbs)	Pre-Consumer Recycled Content (lbs)	Post-Consumer Content (lbs)	CO2e Footprint (kgs)	Users	Install Hours	Concrete (Yds3)	Active Play Events
24	ZZCH8280	1	HOPSCOTCH CLIMBER (72in DECK)	Certified	82.50			161	2	2.00	0.06	1
25	ZZCH8339	1	STEEL CURVE CLIMBER	Certified	48.50			101	1	1.50	0.06	1
26	ZZUN7140	2	STATIONARY BUTTONS (12in)	Certified	54.24			179	2	1.50	0.26	2
27	ZZUN7146	1	STATIONARY BUTTONS (18in)	Certified	27.92			92	1	0.75	0.13	1
28	ZZCH4556	1	7in BELL (POST MOUNT)	Certified	4.61			41	1	0.25	0.00	1
29	ZZCH9887	1	CARNIVAL ROOF - SMALL PERF (HEX)	N/A	158.93			538	0	3.00	0.00	0
30	ZZCH9898	1	CARNIVAL ROOF HEX CAP	Certified	4.60			65	0	0.25	0.00	0
31	ZZCH9170	2	24in ACCESS STEPPED PLATFORM (DECK TO DECK)	Certified	270.48			592	2	4.00	0.00	0
32	ZZUN1471	1	INSTALLER HARDWARE KIT	N/A				57				
33	ZZUN9910	2	SURFACING WARNING LABEL KIT	N/A	0.10			1	0	0.50	0.00	0
34	ZZUN9930	1	PIPE SYSTEMS MAINTENANCE KIT W/ AEROSOL	N/A				90				
35	ZZUN9936	1	MAINTENANCE BOOK	N/A	1.00			TBD	0	0.25	0.00	0
36	ZZXXGNGUIC	2	GENERAL INSTALLERS GUIDE	N/A				1				
Totals:					4,981.64	801	1,404	13,109	71	70.50	4.08	36
					2,241.74 Kg	360 Kg	632 Kg	13 Metric Tons			3.10 m3	



Alpine Park - Scope A

Design Number: MW010524-1 - Compliance and Technical Data

Reference Document: ASTM F1487

Ref. No.	Part No.	Qty.	Description	Unit ASTM Status	Total Weight (lbs)	Pre-Consumer Recycled Content (lbs)	Post-Consumer Content (lbs)	CO2e Footprint (kgs)	Users	Install Hours	Concrete (Yds3)	Active Play Events
----------	----------	------	-------------	------------------	--------------------	-------------------------------------	-----------------------------	----------------------	-------	---------------	-----------------	--------------------

ASTM F1487

The lay-out for this custom playscape, design number MW010524-1, has been configured to meet the requirements of the ASTM F1487 standard. In addition, each of the above components listed as "Certified" have been tested and are IPEMA certified. Components listed as "Not Applicable" do not fall within the scope of the ASTM F1487 standard and have not been tested. IPEMA certification can be verified on the IPEMA website, www.ipema.org. In the interest of playground safety, IPEMA provides a Third Party Certification Service which validates compliance.

2010 ADA Standards for Accessible Design

The lay-out was also designed to meet the 2010 Standards published 15-Sep-2010, by the Department of Justice when installed over a properly maintained surfacing material that is in compliance with ASTM F1951 "Accessibility of Surface Systems Under and Around Playground Equipment" as well as ASTM F1292, "Impact Attenuation of Surfacing Materials Within the Use Zone of Playground Equipment", appropriate for the fall height of the structure.

Installation Times

Installation times are based on one experienced installer. A crew of three experienced individuals can perform the installation within the given time, each member working 1/3 of the given hours. [Eg. Installation Time = 30 hours. For a crew of three, each member will work 10 hours on the installation for a total of 30 hours on the project.]

Carbon Footprint

The CO2e (carbon footprint given in Kilograms and Metric Tons) listed above is a measure of the environmental impact this play structure represents from harvesting raw materials to the time it leaves our shipping dock. Playworld Systems nurtures a total corporate culture that is focused on eliminating carbon producing processes and products, reducing our use of precious raw materials, reusing materials whenever possible and recycling materials at every opportunity. Playworld Systems elected to adopt the Publicly Available Specification; PAS 2050 as published by the British Standards Institute and sponsored by Defra and the Carbon Trust. The PAS 2050 has gained international acceptance as a specification that measures the greenhouse gas emissions in services and goods throughout their entire life cycle.

Pre-Consumer Recycle Content

A measurement, in pounds, that qualifies the amount of material that was captured as waste and diverted from landfill during an initial manufacturing process and is being redirected to a separate manufacturing process to become a different product. E.g. 100% of our Aluminum Tubing is made from captured waste material during the manufacturing process of extruded Aluminum products such as rods, flat bars and H-channels.

Post-Consumer Recycle Content

A measurement, in pounds, that qualifies the amount of material that was once another product that has completed its lifecycle and has been diverted from a landfill as a solid waste through recycling and is now being used in a Playworld Systems' product. E.g. **20% to 40% of the steel in our steel tubing and sheet steel have been diverted from landfills. Automobiles are scrapped and recyclable steel is purchased by the steel mill that produces our raw product.

** The amount of Post-Consumer recycled steel fluctuates daily based on the availability of the recycled steel.



Alpine Park - Scope B

Design Number: MW010524-2 - Bill Of Material

Ref. No.	Part No.	Description	Quantity
Posts			
1	ZZCH0048	3.5in OD x 160in STEEL POST W/ RIVETED CAP	9
2	ZZCH0256	3.5in OD x 212in STEEL POST W/CAP	4
3	ZZPM0036GZ	5in OD X 144in STEEL POST (GROUND ZERO)	7
4	ZZPM0056GZ	5in OD X 168in STEEL POST W/ CAP (GROUND ZERO)	2
Decks & Kick Plates			
5	ZZCH0616	SQUARE COATED DECK ASSEMBLY	1
6	ZZCH0617	TRIANGULAR COATED DECK ASSEMBLY	1
7	zzCH0619	FULL HEX COATED DECK ASSEMBLY	1
ADA Items			
8	ZZCH2027	TRANSFER STATION W/BARRIERS (48in DECK)	1
9	ZZUN2019	APPROACH STEP FOR TRANSFER STATION	1
Slides			
10	ZZCH3126	GLIDE SLIDE (48in DECK)	1
11	ZZCH3205	SLITHER SLIDE ENTRY/ SLIDE-A-SIDE	1
12	ZZCH4696	MIGHTY DESCENT	1
13	ZZUN3208	SLITHER SLIDE 2.0 (RIGHT SECTION)	2
14	ZZUN3219	SLITHER SLIDE ROLLER SECTION	2
15	ZZUN3249	SLITHER SLIDE 2.0 SUPPORT LEG 3ft-6in	1
Barriers			
16	ZZCH4288	ACCESS GATE	1
Climbers			
17	ZZCH6987	INCLINED CLIFF HANGER (48in DECK)	1
18	ZZCH7170	8ft TOWER CLIMBER	1
19	ZZCH7950	SILO CLIMBER (48in DECK)	1
20	ZZCH8939	TRANSITION CLIMBER- CHALLENGER	2
21	ZZUN8727	PLAYCUBE- GROUND LEVEL	3
22	ZZUN8737	PLAYCUBES- SUPPORT POST- 3 CUBES HIGH	1
23	ZZUN8747	PLAYCUBES- ABOVE GROUND- 3 SIDED CONNECTION	1
24	ZZUN8768	INCLINED PASSAGE	3
Ground Zer0 Climbers			
25	ZZPM0297	POST W/ LADDER CLIMBER (36in OR 48in DECK)	2
26	ZZPM5001	TWIN OVERLAY	1
27	ZZPM5003	PITCH CROSSING	1
28	ZZPM5004	TWO-POINT WEDGE	3
29	ZZPM5007	THREE-POINT TRAVERSE - DOUBLE	1
30	ZZPM5008	STEP AROUND	15
Balance			
31	ZZUN7136	UNITY STEPPER - SMALL	3
32	ZZUN7137	UNITY STEPPER - MEDIUM	2
Roofs & Arches			
33	ZZCH9828	CARNIVAL ROOF - SMALL PERF (SQUARE)	1
34	ZZCH9856	CARNIVAL ROOF SQUARE CAP	1



Alpine Park - Scope B

Option B

Design Number: MW010524-2 - Bill Of Material

Ref. No.	Part No.	Description	Quantity
35	ZZCH9887	CARNIVAL ROOF - SMALL PERF (HEX)	1
36	ZZCH9898	CARNIVAL ROOF HEX CAP	1
Stairs and Ladders			
37	ZZCH9170	24in ACCESS STEPPED PLATFORM (DECK TO DECK)	1
Additional Tool & Maintenance Kits			
38	ZZUN1471	INSTALLER HARDWARE KIT	1
39	ZZUN9910	SURFACING WARNING LABEL KIT	2
40	ZZUN9930	PIPE SYSTEMS MAINTENANCE KIT W/ AEROSOL	1
41	ZZUN9936	MAINTENANCE BOOK	1
42	ZZXXGNGUID	GENERAL INSTALLERS GUIDE	2



Option B

Alpine Park - Scope B

Design Number: MW010524-2 - Compliance and Technical Data

Reference Document: ASTM F1487

Ref. No.	Part No.	Qty.	Description	Unit ASTM Status	Total Weight (lbs)	Pre-Consumer Recycled Content (lbs)	Post-Consumer Content (lbs)	CO2e Footprint (kgs)	Users	Install Hours	Concrete (Yds3)	Active Play Events
1	ZZXX0065	1	SPIN CUP	Certified	57.21			301	1	2.00	0.12	1
2	ZZXX0260	2	BELT SEAT W/SILVER SHIELD CHAIN FOR 8ft TOP RAIL	Certified	17.60			108	2	0.50	0.00	2
3	ZZXX0265	1	INFANT SEAT W/SILVER SHIELD FOR 8ft TOP RAIL	Certified	11.31			90	1	0.25	0.00	1
4	ZZXX0483	1	COZY COCOON - SPINNING	Certified	132.00			834	3	1.50	0.13	1
5	ZZXX0818	1	8ft SINGLE POST SWING ASSEMBLY	N/A	257.68			159	0	2.00	0.24	0
6	ZZXX0819	1	8ft SINGLE POST SWING ADD-A-BAY	N/A	169.58			109	0	2.00	0.12	0
7	ZZXX0880	1	COMMUNITY HELPERS W/ TUNNEL	Certified	1,703.10			5,705	20	12.00	1.10	12
8	ZZXX0887	1	CHATTERY	Certified	587.50			1,480	10	10.00	0.48	2
9	ZZXX0892	1	ACCESSIBLE SWING SEAT- 8ft TOP RAIL	Certified	51.90			639	1	0.50	0.00	1
10	ZZCH0048	9	3.5in OD x 160in STEEL POST W/ RIVETED CAP	Certified	451.89			612	0	9.00	1.13	0
11	ZZCH0256	4	3.5in OD x 212in STEEL POST W/CAP	Certified	248.04			374	0	4.00	0.52	0
12	ZZPM0036GZ	7	5in OD X 144in STEEL POST (GROUND ZERO)	Certified	562.87			822	0	10.50	1.26	0
13	ZZPM0056GZ	2	5in OD X 168in STEEL POST W/ CAP (GROUND ZERO)	Certified	194.02			271	0	2.00	0.36	0
14	ZZCH0616	1	SQUARE COATED DECK ASSEMBLY	Certified	54.86			174	3	1.00	0.00	0
15	ZZCH0617	1	TRIANGULAR COATED DECK ASSEMBLY	Certified	29.90			120	2	1.00	0.00	0
16	zzCH0619	1	FULL HEX COATED DECK ASSEMBLY	Certified	151.26			444	6	1.50	0.00	0
17	ZZCH2027	1	TRANSFER STATION W/BARRIERS (48in DECK)	Certified	261.30			492	3	2.50	0.09	0
18	ZZUN2019	1	APPROACH STEP FOR TRANSFER STATION	Certified	35.83			72	1	1.00	0.04	0
19	ZZCH3126	1	GLIDE SLIDE (48in DECK)	Certified	119.73			492	2	1.50	0.03	1
20	ZZCH3205	1	SLITHER SLIDE ENTRY/ SLIDE-A-SIDE	Certified	120.20			339	2	2.00	0.03	1
21	ZZCH4696	1	MIGHTY DESCENT	Certified	748.80			1,285	8	7.00	0.18	1
22	ZZUN3208	2	SLITHER SLIDE 2.0 (RIGHT SECTION)	Certified	39.18			267	0	0.50	0.00	0
23	ZZUN3219	2	SLITHER SLIDE ROLLER SECTION	Certified	67.60			944	0	0.50	0.00	0



Option B

Alpine Park - Scope B

Design Number: MW010524-2 - Compliance and Technical Data

Reference Document: ASTM F1487

Ref. No.	Part No.	Qty.	Description	Unit ASTM Status	Total Weight (lbs)	Pre-Consumer Recycled Content (lbs)	Post-Consumer Content (lbs)	CO2e Footprint (kgs)	Users	Install Hours	Concrete (Yds3)	Active Play Events
24	ZZUN3249	1	SLITHER SLIDE 2.0 SUPPORT LEG 3ft-6in	Certified	15.01			62	0	0.25	0.03	0
25	ZZCH4288	1	ACCESS GATE	Certified	17.34			65	0	0.50	0.00	0
26	ZZCH6987	1	INCLINED CLIFF HANGER (48in DECK)	Certified	107.60			447	1	2.00	0.06	1
27	ZZCH7170	1	8ft TOWER CLIMBER	Certified	115.62			263	2	2.00	0.90	1
28	ZZCH7950	1	SILO CLIMBER (48in DECK)	Certified	74.18			134	1	1.50	0.06	1
29	ZZCH8939	2	TRANSITION CLIMBER- CHALLENGER	Certified	110.28			429	4	5.00	0.00	2
30	ZZUN8727	3	PLAYCUBE- GROUND LEVEL	Certified	454.86			1,287	12	4.50	0.36	3
31	ZZUN8737	1	PLAYCUBES- SUPPORT POST- 3 CUBES HIGH	Certified	15.20			23	0	1.00	0.03	0
32	ZZUN8747	1	PLAYCUBES- ABOVE GROUND- 3 SIDED CONNECTION	Certified	99.58			375	3	1.50	0.00	1
33	ZZUN8768	3	INCLINED PASSAGE	Certified	106.80			110	9	3.00	0.00	3
34	ZZPM0297	2	POST W/ LADDER CLIMBER (36in OR 48in DECK)	Certified	149.62			263	2	1.00	0.26	2
35	ZZPM5001	1	TWIN OVERLAY	Certified	284.60			3,360	8	2.00	0.00	1
36	ZZPM5003	1	PITCH CROSSING	Certified	165.30			771	2	4.00	0.15	1
37	ZZPM5004	3	TWO-POINT WEDGE	Certified	301.80			2,146	12	7.50	0.30	3
38	ZZPM5007	1	THREE-POINT TRAVERSE - DOUBLE	Certified	172.80			1,066	6	3.00	0.10	1
39	ZZPM5008	15	STEP AROUND	Certified	102.00			1,608	15	7.50	0.00	15
40	ZZUN7136	3	UNITY STEPPER - SMALL	Certified	89.91			207	3	3.00	0.39	3
41	ZZUN7137	2	UNITY STEPPER - MEDIUM	Certified	109.42			290	2	2.00	0.26	2
42	ZZCH9828	1	CARNIVAL ROOF - SMALL PERF (SQUARE)	N/A	116.18			341	0	2.00	0.00	0
43	ZZCH9856	1	CARNIVAL ROOF SQUARE CAP	Certified	4.61			23	0	0.25	0.00	0
44	ZZCH9887	1	CARNIVAL ROOF - SMALL PERF (HEX)	N/A	158.93			538	0	3.00	0.00	0
45	ZZCH9898	1	CARNIVAL ROOF HEX CAP	Certified	4.60			65	0	0.25	0.00	0
46	ZZCH9170	1	24in ACCESS STEPPED PLATFORM (DECK TO DECK)	Certified	135.24			296	1	2.00	0.00	0
47	ZZUN1471	1	INSTALLER HARDWARE KIT	N/A				57				
48	ZZUN9910	2	SURFACING WARNING LABEL KIT	N/A	0.10			1	0	0.50	0.00	0



Option B

Alpine Park - Scope B

Design Number: MW010524-2 - Compliance and Technical Data

Reference Document: ASTM F1487

Ref. No.	Part No.	Qty.	Description	Unit ASTM Status	Total Weight (lbs)	Pre-Consumer Recycled Content (lbs)	Post-Consumer Content (lbs)	CO2e Footprint (kgs)	Users	Install Hours	Concrete (Yds3)	Active Play Events
49	ZZUN9930	1	PIPE SYSTEMS MAINTENANCE KIT W/ AEROSOL	N/A				90				
50	ZZUN9936	1	MAINTENANCE BOOK	N/A	1.00			TBD	0	0.25	0.00	0
51	ZZXXGNGUIC	2	GENERAL INSTALLERS GUIDE	N/A				1				
Totals:					8,985.94	1,714	2,999	30,448	148	134.25	8.72	63
					4,043.67 Kg	771 Kg	1,350 Kg	30 Metric Tons				6.63 m3



Alpine Park - Scope B

Design Number: MW010524-2 - Compliance and Technical Data

Reference Document: ASTM F1487

Ref. No.	Part No.	Qty.	Description	Unit ASTM Status	Total Weight (lbs)	Pre-Consumer Recycled Content (lbs)	Post-Consumer Content (lbs)	CO2e Footprint (kgs)	Users	Install Hours	Concrete (Yds3)	Active Play Events
----------	----------	------	-------------	------------------	--------------------	-------------------------------------	-----------------------------	----------------------	-------	---------------	-----------------	--------------------

ASTM F1487

The lay-out for this custom playscape, design number MW010524-2, has been configured to meet the requirements of the ASTM F1487 standard. In addition, each of the above components listed as "Certified" have been tested and are IPEMA certified. Components listed as "Not Applicable" do not fall within the scope of the ASTM F1487 standard and have not been tested. IPEMA certification can be verified on the IPEMA website, www.ipema.org. In the interest of playground safety, IPEMA provides a Third Party Certification Service which validates compliance.

2010 ADA Standards for Accessible Design

The lay-out was also designed to meet the 2010 Standards published 15-Sep-2010, by the Department of Justice when installed over a properly maintained surfacing material that is in compliance with ASTM F1951 "Accessibility of Surface Systems Under and Around Playground Equipment" as well as ASTM F1292, "Impact Attenuation of Surfacing Materials Within the Use Zone of Playground Equipment", appropriate for the fall height of the structure.

Installation Times

Installation times are based on one experienced installer. A crew of three experienced individuals can perform the installation within the given time, each member working 1/3 of the given hours. [Eg. Installation Time = 30 hours. For a crew of three, each member will work 10 hours on the installation for a total of 30 hours on the project.]

Carbon Footprint

The CO2e (carbon footprint given in Kilograms and Metric Tons) listed above is a measure of the environmental impact this play structure represents from harvesting raw materials to the time it leaves our shipping dock. Playworld Systems nurtures a total corporate culture that is focused on eliminating carbon producing processes and products, reducing our use of precious raw materials, reusing materials whenever possible and recycling materials at every opportunity. Playworld Systems elected to adopt the Publicly Available Specification; PAS 2050 as published by the British Standards Institute and sponsored by Defra and the Carbon Trust. The PAS 2050 has gained international acceptance as a specification that measures the greenhouse gas emissions in services and goods throughout their entire life cycle.

Pre-Consumer Recycle Content

A measurement, in pounds, that qualifies the amount of material that was captured as waste and diverted from landfill during an initial manufacturing process and is being redirected to a separate manufacturing process to become a different product. E.g. 100% of our Aluminum Tubing is made from captured waste material during the manufacturing process of extruded Aluminum products such as rods, flat bars and H-channels.

Post-Consumer Recycle Content

A measurement, in pounds, that qualifies the amount of material that was once another product that has completed its lifecycle and has been diverted from a landfill as a solid waste through recycling and is now being used in a Playworld Systems' product. E.g. **20% to 40% of the steel in our steel tubing and sheet steel have been diverted from landfills. Automobiles are scrapped and recyclable steel is purchased by the steel mill that produces our raw product.

** The amount of Post-Consumer recycled steel fluctuates daily based on the availability of the recycled steel.





MIDWEST PLAYSCAPES

PROUDLY SERVING
MINNESOTA
WISCONSIN
IOWA
NORTH DAKOTA
SOUTH DAKOTA
SINCE 1991



ABOUT US

Since 1991, Midwest Playscapes, Inc. has been establishing an excellent reputation as the premier playground and park consultant in Minnesota and the Dakotas. Our clients include: architects, schools, Faith-based organizations, multi-housing and park and rec. departments. Our services include: design, consultation, sales, construction, inspection, auditing, relocation, and replacement parts services. As a generational family owned business, every Midwest Playscapes employee is committed to ensuring excellent customer service in order to establish strong and lasting partnerships with our clients. We are happy to provide references upon request. We have extensive training and experience in playground, picnic shelter, and landscape construction, including over 2,000 company installations and 500 community built projects.

OUR SERVICES



DESIGN

Partnering with our clients, we design playgrounds, parks, and landscapes which offer the most beautiful, exciting, and inclusive experience possible. We specialize in inclusive playgrounds; working closely with child developmental psychologists, schools which specialize in support for children with Autism Spectrum Disorders (ASD), and other experts to design our inclusive playgrounds. We look forward to consulting you on the design, planning, and construction of your next inclusive playground.



PLANING

We offer complimentary consultation services to our clients, evaluating their needs, informing them of their options, and advising them in creating a plan to accomplish their project goals, within their budget constraints. Our consultation services include: Inclusive Playground Design, 3D CAD Design, Site Planning, Fund Raising, ADA Evaluation, Equipment Inspection/Audit/Repair/Install/Relocation and more.



CONSTRUCTION

Our design consultants work closely with our clients and on-staff Installers (CPSI/RISC), to ensure perfect implementation of the plan during the construction phase. Using our in-house installation crews, we are able to ensure quality installations done in a timely and professional manner. We offer both full and community-build style installations.



SAFETY INSPECTIONS

Our playground designers, consultants, and installers are certified by the National Playground Safety Institute as Certified Playground Safety Inspectors and can provide full written playground audits or simple visual inspections.



RELOCATION & RE-SURFACING

We are available to assist you in relocating playgrounds of any size, regardless of manufacturer, anywhere in the Midwest. Contact us to find out how we can resurface your playground from sand/pea gravel to an inclusive and accessible surface like poured in place or artificial turf.



1-800-747-1452 or 952-895-8888



INFO@MIDWESTPLAYSCAPES.COM



www.MIDWESTPLAYSCAPES.com



For over 30 years, Midwest Playscapes, Inc. continues to be a leader in the commercial recreation industry. We take pride in serving our communities through the creation of sustainable, accessible, inclusive, playgrounds, fitness areas, splash-pads, and public spaces. We proudly represent industry-leading manufacturers including: Playworld Systems, Duncan & Grove, Waterplay, ID Sculptures, Outdoor-Fit, RCP Shelters, USA Shade, Bison Sports & Rec, and more.

OUR STAFF

Our staff of experienced professionals includes: 4 Certified Playground Safety Inspectors, 3 Inclusive Design Certified Project Planners, a dedicated placement parts person, factory certified installers, a dedicated installation coordinator, an in-house CAD design department, and 3 fully outfitted installation crews.

We conduct business in Minnesota, Wisconsin, South Dakota, North Dakota, and Iowa, an area encompassing over 17 million people. Our first priority has always been providing the best possible customer service and we believe our track record reflects that core value.



MANUFACTURER AWARDS

- 2021 PLAYWORLD DEALER OF THE YEAR
- 2021 \$5 MILLION CLUB
- 2017 NATIONAL LEADER, CUSTOMER SATISFACTION AWARD.
- 2016 CUSTOMER SATISFACTION AWARD.
- 2001-2017 MEMBER OF PLAYWORLD SYSTEMS MILLION DOLLAR CLUB.
- 2012 & 2010 PLAYWORLD SYSTEMS MOST IMPROVED ORGANIZATION.
- 2014, 2012, 2010, 2002, & 2001 BRONZE AWARD OF EXCELLENCE.
- 2004 AWARD OF EXCELLENCE FOR CUSTOMER SATISFACTION & SERVICE.
- 2010 ONE OF PLAYWORLD SYSTEMS TOP THREE DISTRIBUTORS OF THE YEAR.
- 1999 AND 2000 SILVER AWARD OF EXCELLENCE FOR CUSTOMER SATISFACTION AND SERVICE.

PROUDLY REPRESENTING



RCP Shelters, Inc.



USASHADE
& Fabric Structures



WATERPLAY[®] BY MAKE



OUTDOOR-FIT
exercise systems



Proposal for Design, Provision and Install of Play Equipment at Alpine Park.

\$ 100,000.00 for all costs to complete installation of play structures and site work referenced in Proposal Scope A.

\$ 170,000.00 for all costs to complete installation of play structures and site work referenced in Proposal Scope B.

In submitting the above proposal(s), I/We warrant the quoted amount valid for work to be completed on or before June 30th, 2024—and that all costs associated with the project are included, (equipment, fuel, materials, structures, delivery, installation, construction permits, taxes and service charges). Bidders/Contractors need only include this page (not the whole RFP) with their submittals.

Additionally, I/we acknowledge the specifications and provisions referenced herein and above.

Contractor name Midwest Playscapes

Owner or representative Dominic Dvorak

Signature Dominic Dvorak

Phone(s) 952-895-8888

E-mail dom@midwestplayscapes.com



8632 Eagle Creek Circle, Savage, MN 55378
www.MIDWESTPLAYSCAPES.com

direct: 952.895.8888 **Option A**
 fax: 952.895.8889
 toll free: 800.747.1452

playscapes@earthlink.net



Quotation

Project: Alpine Park - Scope A - City of Ramsey
Contact: Mariah Albrecht
Ship To: 6600 Alpine Drive NW
 Ramsey, MN 55303
Email: malbrecht@cityoframsey.com

Phone: 763-433-9820
Fax:
Bill To:

Shipping Contact Name:

Date: 1/8/24

Qty	Design/Item #	Description	Total
1	MW010524-1	Playworld Playground *Price includes all play equipment, Poured-in-Place, and Engineered Wood Fiber as shown on design #MW010524-1	\$ 95,674.00
133 linear ft		6" x 12" Concrete Curb Border	\$ 3,325.00
		Discount	\$ (15,272.00)
			Subtotal \$ 83,727.00
			Freight \$ 3,500.00
			Sales Tax
			Local Sales Tax
			Total \$ 87,227.00

Tax Exempt # _____ * Please provide certificate

Options

Add \$12,773 for installation of all play equipment and safety surfacing shown in design #MW010524-1, and all site prep including removal and disposal of existing play equipment and safety surfacing.

NOTE: Any Insurance requirements above \$1,000,000 General Liability will be subject to a surcharge

NOTE: UNLESS OTHERWISE NOTED, prices shown are material only. They DO NOT include: assembly, installation, border, safety surfacing, drain tile, geotextile fabric, removal of existing equipment, site preparation, excavation or site restoration, unloading of equipment, disposal of packaging material, storage of equipment, additional insurance and bonding would be extra, unless otherwise stated above. If playground equipment or materials are stored off site, customer is responsible for transporting equipment to job site.

Prices firm for 30 days, subject to review thereafter. Our terms are net 30. A finance charge of 1.5% will be imposed on the outstanding balance unpaid for more than 30 days after the shipment of materials. Equipment shall be invoiced separately from other services and shall be payable in advance of those services and project completion. Retainage not accepted. Once customer has signed quotation, your order cannot be changed or canceled. Please allow TBD weeks for delivery after receipt of order. Standard manufacturing design, specification, and construction apply unless noted otherwise. Customer is responsible for the identification and marking of all underground utilities (public or private) to include drain tile and sprinkler systems. Area must be accessible to Bobcat and other equipment necessary for installation or additional fees will be charged. Freight quote is based on customer unloading equipment and checking in all equipment for any missing parts. If product is refused by customer upon delivery for any reason (unless damaged), without prior authorization from Midwest Playscapes, Inc., the customer agrees to pay 20% restocking fee plus freight charges. Price does not include prevailing wages, unless otherwise noted. If we can be of Other Assistance, please feel free to contact us.

Signed: Dominic Dvorak
 Dominic Dvorak

Accepted _____
 Date: _____
 Printed Name: _____



8632 Eagle Creek Circle, Savage, MN 55378
www.MIDWESTPLAYSCAPES.com

direct: 952.895.8888 **Option B**
 fax: 952.895.8889
 toll free: 800.747.1452

playscapes@earthlink.net



Quotation

Project: Alpine Park - Scope B - City of Ramsey
Contact: Mariah Albrecht
Ship To: 6600 Alpine Drive NW
 Ramsey, MN 55303
Email: malbrecht@cityoframsey.com
Shipping Contact Name:

Phone: 763-433-9820
Fax:
Bill To:

Date: 1/8/24

Qty	Design/Item #	Description	Total
1	MW010524-2	Playworld Playground *Price includes all play equipment, Poured-in-Place, and Engineered Wood Fiber as shown on design #MW010524-2	\$ 169,606.00
284 linear ft		6" x 12" Concrete Curb Border	\$ 7,100.00
		Discount	\$ (32,421.00)
			Subtotal \$ 144,285.00
			Freight \$ 3,800.00
Tax Exempt # _____ * Please provide certificate			Sales Tax
			Local Sales Tax
			Total \$ 148,085.00

Options
 Add \$21,915 for installation of all play equipment and safety surfacing shown in design #MW010524-2, and all site prep including removal and disposal of existing play equipment, safety surfacing, and a portion of existing curb.

NOTE: Any Insurance requirements above \$1,000,000 General Liability will be subject to a surcharge

NOTE: UNLESS OTHERWISE NOTED, prices shown are material only. They DO NOT include: assembly, installation, border, safety surfacing, drain tile, geotextile fabric, removal of existing equipment, site preparation, excavation or site restoration, unloading of equipment, disposal of packaging material, storage of equipment, additional insurance and bonding would be extra, unless otherwise stated above. If playground equipment or materials are stored off site, customer is responsible for transporting equipment to job site.

Prices firm for 30 days, subject to review thereafter. Our terms are net 30. A finance charge of 1.5% will be imposed on the outstanding balance unpaid for more than 30 days after the shipment of materials. Equipment shall be invoiced separately from other services and shall be payable in advance of those services and project completion. Retainage not accepted. Once customer has signed quotation, your order cannot be changed or canceled. Please allow TBD weeks for delivery after receipt of order. Standard manufacturing design, specification, and construction apply unless noted otherwise. Customer is responsible for the identification and marking of all underground utilities (public or private) to include drain tile and sprinkler systems. Area must be accessible to Bobcat and other equipment necessary for installation or additional fees will be charged. Freight quote is based on customer unloading equipment and checking in all equipment for any missing parts. If product is refused by customer upon delivery for any reason (unless damaged), without prior authorization from Midwest Playscapes, Inc., the customer agrees to pay 20% restocking fee plus freight charges. Price does not include prevailing wages, unless otherwise noted. If we can be of Other Assistance, please feel free to contact us.

Signed: Dominic Dvorak
 Dominic Dvorak

Accepted _____
 Date: _____
 Printed Name: _____



NO FAULT SAFETY SURFACE
PRODUCT WARRANTY - Five (5) Yr. FULL

NO FAULT LLC
3112 Valley Creek Drive, Ste. C
Baton Rouge, LA 70808
225-215-7760 www.nofault.com

Project Name: SAMPLE WARRANTY
Address:

NF Job No.:
Customer:
Date of Completion:

NO FAULT LLC ("NF") warrants to the original purchaser (established as "Customer" above) that the No Fault Safety Surface ("NFSS"), installed under the above referenced Project, will conform to the NFSS specifications and remain free from defects in materials and workmanship for a period of five (5) years, per the terms and conditions provided herein.

This limited warranty shall provide for one hundred percent (100%) of the cost to repair or replace of any defective materials or workmanship in the surface area(s) that fail during the warranty period. This includes a failure of the surface to maintain impact attenuation values at or below 1000 HIC and/or 200 GMAX, when tested in accordance with the ASTM F1292 version effective at the time of installation. This warranty shall commence on the date of substantial completion (as established above) and shall expire exactly three years later. This limited warranty is expressly made in lieu of any other warranties and is exclusive to the original Customer.

All warranty claims shall be made in writing to NF within thirty (30) days of the Customer's knowledge thereof. The written notification from the Customer shall include the following: the date of the first notice of the failure, details of the failure, photos of the failed area and a request for a warranty claim meeting with NF at the installation site (if applicable). NF shall determine the validity of all claims after sufficient evidence has been gathered. NF shall then replace, repair, or make a refund for any claims validated by it. Any refund, credit or allowance provided to the Customer on a warranty claim is exercisable only if said allowance is used to accommodate replacement with NF's then current surfacing system. NF's liability for warranty claims shall in no event exceed the cost of repair or replacement of such area(s) that have failed. Customer agrees that in no event shall NF have any liability to Customer for loss of use or loss of profits or any form of consequential damages.

Any dispute as to whether and to what extent there is a NFSS product failure and subsequent valid warranty claim within the meaning of this warranty shall be initially dealt with by joint investigation and discussion between NF and Customer in order to achieve a mutually agreeable solution. If a solution cannot be reached within thirty (30) days, then either the Customer or NF may submit the matter to an accredited arbitrator who is a member of the American Arbitration Association and who shall make a determination in accordance with the rules and regulation of the American Arbitration Association. The decision of the Arbitrator shall be binding on both parties.

This warranty does not include normal wear and tear, discoloration or fading as a result of ultraviolet rays, shrinkage (which is an inherent characteristic of elastic rubber), any damages to the surface during the curing period, or improper sub-base design or construction, including but not limited to surface cracking along expansion joints or separating from an adjacent border, curb, walkway, or existing surface. If the underlying sub-base materials fail for any reason whatsoever (including hydrostatic pressure, cracking, shifting, heaving), then NF's warranty shall be rendered invalid.

NF is under no obligation or responsibility to repair and/or replace the NFSS product if damaged by lawn and landscaping equipment; vehicular traffic; vandalism (including burns, cuts, gouges, etc.); product misuse, abuse or alteration; improper drainage; improper or lack of maintenance; any foreign residue that may be deposited on the surface; any foreign matter from surrounding areas (i.e. any substance other than those indicated on NF's MSDS sheets) that may be siphoned through, migrated in, lodged in and/or harden the surface; sharp objects (high heels, spikes, etc.); use of unapproved cleaning materials; or acts of God.

Specifically regarding Underwater, Water Play, and Pool-deck applications, foreign or excessive chemicals in the water can cause potential damage to the NFSS product resulting in fading, chalking, bleeding, and/or degradation. Pool chemicals and water treatments such as "Ozone" and chlorine levels with a ppm of greater than 3 will harm and degrade the NFSS product. NF will not warrant the NFSS product when foreign or excessive chemicals are used in or around the surface installation. NF will not warrant against mold or mildew caused by improper drainage and/or improper sloping around the pool area, sauna area, steam area or shower area. Recommended minimum slope for positive drainage is 2% for areas over 2000 SF.

Customer acknowledges that the limited warranty will be voided if the Customer fails to follow the NFSS Maintenance Guidelines (attached hereto); keep maintenance and impact attenuation testing records; or fails to make payment in a timely manner as per the terms and conditions of the agreed contract. Customer also acknowledges and agrees that it will not, under any circumstance, make alterations to the NFSS without the written authorization of NF. Any unauthorized alteration by the Customer could result in the termination of any existing warranty for the NFSS and shall also give rise to the duty of the Customer to hold harmless, defend and indemnify NF from any claim, suit or cause of action, personal injury, death, or property damage arising out of or related to said alteration.

WARNING: Surface areas can become extremely hot due to exposure of direct sunlight. Shoes and/or socks must be worn at all times. Customer is responsible for proper supervision of children when in contact with the surface. In addition, warning signs are recommended to be posted in all areas to prevent small children from touching or crawling on to surface areas that may be hot due to extended sun exposure in excessive temperatures. During winter and/or seasons when temperatures fall below 32°F, the impact attenuation performance of the NFSS system can be compromised. In this case, it is recommended to discontinue use until surface is no longer frozen. No Fault Sport Group assumes no liability to such exposure of surfacing temperature as this should be monitored prior to use of surfacing. No Fault Sport Group also assumes no liability to the expansion and contraction of the surfacing during freeze/thaw events.

NO REPRESENTATIVE OF THE SELLER HAS AUTHORITY TO MAKE ANY REPRESENTATION OR PROMISES EXCEPT AS STATED HEREIN. THERE ARE NO WARRANTIES EITHER EXPRESSED OR IMPLIED, INCLUDING THE IMPLIED WARRANTIES OF MERCHANTABILITY AND FITNESS FOR A PARTICULAR PURPOSE THAT EXTEND BEYOND THE WARRANTIES CONTAINED IN THIS DOCUMENT. NF SHALL NOT BE LIABLE FOR ANY INCIDENTAL, CONSEQUENTIAL OR OTHER DAMAGES TO THE STRUCTURE OR ITS CONTENTS ARISING UNDER ANY THEORY OF LAW WHATSOEVER.

NO FAULT LLC:

Jay Ratelle, Vice President of Operations

Warranty issue date:

PLAYWORLD LIMITED WARRANTY

Playworld Systems, Inc. warrants its products against structural failure due to defects in materials and workmanship for the warranty periods and material categories prescribed below.

- LIMITED WARRANTY FOR AS LONG AS YOU OWN THE PRODUCT:** Steel and aluminum deck support posts, stainless steel hardware, clamps, deck hangers, post caps, and cast aluminum parts, except as otherwise specified below.
- LIMITED TWENTY-FIVE (25) YEAR WARRANTY:** Spring Mates® aluminum castings.
- LIMITED FIFTEEN (15) YEAR WARRANTY:** Perforated steel decks and stairs, steel rails, stationary weldments, rotationally-molded and sheet plastic components, recycled plastic lumber, roof panels, and stainless steel slides, except as otherwise specified below by product family type.
- LIMITED TEN (10) YEAR WARRANTY:** Fiberglass signage, accessible swing seats, Fun Centers™, FirstPlay™ play structures, pre-cast PolyFiberCrete® or reinforced concrete products, Timber Stacks™ Robinia timbers and galvanized hardware, Hat Shade fabric and components, Shade Canopy fabric and components, Hypar Shade fabric and components, and Shadesure and Colourshade FR fabrics. (Note Exception: Limited Five (5) Year Warranty on fabrics in colors Red, Yellow, Electric Purple, Zesty Lime, Cinnamon, and Olive.)
- LIMITED FIVE (5) YEAR WARRANTY:** Steel reinforced cable net and rope fittings and connections (Note Exception: Warranty does not cover normal wear and tear such as fraying or fading of cable coating), PlaySimple® play structures, DropZone Tower™, LiveWire Zip Line™, AeroGlider™, Border Timbers™, flex treads, wood and polycarbonate panels, Eco-Armor coating and PVC coating (against cracking and peeling), site amenities (i.e. benches, tables, litter receptacles, and bike racks), GFRP (Glass Fiber Reinforced Polymer) products, and motion/moving play components and parts.
- LIMITED THREE (3) YEAR WARRANTY:** Steel coil and C springs, flat webbing nets (excluding normal wear and tear), electronic panel speakers, sound chips, and circuit boards.
- LIMITED ONE (1) YEAR WARRANTY:** NEOS®, electronic based play products, swing chain, swing clevises, swing galvanized attachment hardware, molded rubber bumpers, handholds, swing seats, and any other materials or custom products not covered above. (*For NEOS only, an extended 3-year warranty is available for purchase, providing 4 years of cumulative coverage.)

BUYER'S REMEDY: If any products prove defective or non-conforming under normal use and within the above-prescribed warranty periods and material categories, Buyer must promptly notify Playworld Systems, Inc. in writing at 1000 Buffalo Road, Lewisburg, PA 17837 USA. Playworld may elect to inspect the alleged defect at Buyer's site or at Playworld's facility. Buyer shall not return products to Playworld unless authorized by Playworld to do so. Authorized returns must be properly packaged and shipped prepaid and insured, at Buyer's expense. Upon verification of warranty coverage, Playworld may elect, in its sole discretion, to repair defective or non-conforming products, or replace them by delivering products or parts free of charge to the site. Playworld's limited warranties do not cover the cost of labor to remove defective or non-conforming parts or to install repaired or replacement parts. By use of these limited warranties, Buyer accepts their terms and limitations, and waives any rights it would otherwise have to claim or assert that such warranties fail of their

essential purpose. Buyer agrees that venue for any court action to enforce these limited warranties shall be in Union County in the State of Pennsylvania.

LIMITATIONS: All warranty periods begin on the date of Playworld's invoice. Repaired and/or replacement parts are warranted only for the balance of the original limited warranty period. Warranties extend only to the original Buyer/end user for products purchased from Playworld or a Playworld authorized reseller, and are not transferable.

Warranties apply only to Playworld products that are erected and installed in conformance with Playworld installation instructions, and that are maintained and inspected in conformance with Playworld maintenance and operational instructions.

Warranties specifically do not cover Playworld products:

- for cosmetic damage or flaws occurring under normal use, such as surface scratches, minor chips, hairline cracks, dents, marring, efflorescence, color fade, discoloration, corrosion/rust, fraying, or warping of recycled plastic lumber;
- that have been modified, altered, or repaired by unauthorized third parties;
- that have not been used as designed or intended, or misused;
- to which non-Playworld parts have been added or substituted;
- that have been removed from their original location and re-installed elsewhere;
- for changes in appearance of natural materials over time or cosmetic defects such as checks or splits in timber components;
- or that have been damaged due to excessive wear and tear, vandalism, abnormal use, abuse, negligence, environmental factors (such as wind-blown sand, salt spray, or airborne emissions from industrial sources), extreme weather (such as hail, flooding, lightning, tornados, sandstorms, earthquakes, or wind storms), and acts of God.

Playworld does not warrant that any particular color will be available for any specific period of time, and reserves the right, in its sole discretion, to discontinue any color for any reason.

THE FOREGOING LIMITED WARRANTY IS THE SOLE AND EXCLUSIVE WARRANTY FOR SELLER'S PRODUCTS, AND IS IN LIEU OF ALL OTHER WARRANTIES, EXPRESS OR IMPLIED, IN LAW OR IN FACT. SELLER SPECIFICALLY DISCLAIMS ALL OTHER WARRANTIES, EXPRESS OR IMPLIED, INCLUDING, WITHOUT LIMITATION, ALL IMPLIED WARRANTIES OF MERCHANTABILITY AND FITNESS FOR A PARTICULAR USE OR PURPOSE, AND ANY IMPLIED WARRANTIES ARISING OUT OF COURSE OF DEALING OR PERFORMANCE OR TRADE USAGE. SELLER SHALL NOT BE LIABLE FOR ANY INCIDENTAL, CONSEQUENTIAL, EXEMPLARY, SPECIAL, OR PUNITIVE DAMAGES, OR ANY LOSS OF REVENUE, PROFIT, OR USE ARISING OUT OF A BREACH OF THIS WARRANTY OR IN CONNECTION WITH THE SALE, INSTALLATION, MAINTENANCE, USE, OPERATION, OR REPAIR OF ANY PRODUCT. IN NO EVENT WILL SELLER BE LIABLE FOR ANY AMOUNT GREATER THAN THE PURCHASE PRICE OF A DEFECTIVE PRODUCT.

Safety & Standards



CERTIFICATIONS AND SAFETY STANDARDS: ISO 14001 certification guarantees that Playworld Systems, Inc. meets the highest standards for environmental-responsible manufacturing.



ISO 9001 certification guarantees that Playworld Systems, Inc. meets stringent quality-control standards in manufacturing our play equipment.

The Consumer Product Safety Commission (CPSC) – Look for “CPSC Pub.325” to see Playworld Systems, Inc.’s CPSC-compliant products.

- **CPSIA** – Playworld Systems, Inc.’s products meet or exceed the requirements of the Consumer Products Safety Improvement Act (CPSIA) of 2008.



The European Norm (EN) covers general safety requirements and test methods. Look for “EN1176” to see Playworld Systems, Inc.’s EN-compliant products.



The European RoHS directive restricts the use of six hazardous materials in the manufacture of electronic equipment, and seeks to reduce the amount of hazardous materials entering electronic products. All Playworld Systems, Inc.’s electronic products are RoHS compliant.

- **Singaporean Standard** – Based primarily on the ASTM standards, the Singaporean Standard is widely used throughout Asia.



Playworld Systems, Inc. is a founding member of the **International Play Equipment Manufacturers Association**

(IPEMA), a member-driven organization whose mission is to assist in providing safe environments for children to play. In the interest of playground safety, IPEMA provides a third-party certification service, whereby a designated independent laboratory, TUV America, validates a participant's certification of conformance to the following standards:



- **ASTM F1487** – Standard Consumer Safety Performance Specification for Playground Equipment for Public Use



- **CAN/CSA Z614** – Guideline on Children's Play Spaces and Equipment



- **ASTM F1292** – Standard Specification for Impact Attenuation Under and Around Playground Equipment

The use of the corresponding IPEMA certification logos (shown left) signify that Playworld Systems, Inc. has received written validation from an independent laboratory that the product associated with the use of the logo conforms with the requirements of the indicated standard. Check the IPEMA website (ipema.org) to confirm product validation.

Playworld Systems, Inc. is proud to hold these prestigious designations. For more information regarding the above standards, visit Playworld.com/Standards or contact your local Playworld Systems, Inc. representative.

TERMS OF SALE • PRICES: Prices are subject to change without notice. Unless otherwise stated in writing, all prices are F.O.B. Lewisburg, PA, USA, and shall be exclusive of installation, surfacing, transportation, insurance, taxes, license fees, customs fees, duties, premiums, fees, and other charges. **DESIGN:** Playworld Systems, Inc. continually improves play equipment to better serve our customers and therefore reserves the right to change the design specifications without notice.



CERTIFICATE OF LIABILITY INSURANCE

DATE (MM/DD/YYYY)

5/18/2023

THIS CERTIFICATE IS ISSUED AS A MATTER OF INFORMATION ONLY AND CONFERS NO RIGHTS UPON THE CERTIFICATE HOLDER. THIS CERTIFICATE DOES NOT AFFIRMATIVELY OR NEGATIVELY AMEND, EXTEND OR ALTER THE COVERAGE AFFORDED BY THE POLICIES BELOW. THIS CERTIFICATE OF INSURANCE DOES NOT CONSTITUTE A CONTRACT BETWEEN THE ISSUING INSURER(S), AUTHORIZED REPRESENTATIVE OR PRODUCER, AND THE CERTIFICATE HOLDER.

IMPORTANT: If the certificate holder is an ADDITIONAL INSURED, the policy(ies) must have ADDITIONAL INSURED provisions or be endorsed. If SUBROGATION IS WAIVED, subject to the terms and conditions of the policy, certain policies may require an endorsement. A statement on this certificate does not confer rights to the certificate holder in lieu of such endorsement(s).

PRODUCER CIA Insurance 122 W Main St, PO Box 38 Lime Springs, IA 52155	CONTACT NAME: PHONE (A/C, No, Ext): (563) 566-2621	FAX (A/C, No): (563) 566-0906	
	E-MAIL ADDRESS:		
INSURED Midwest Playscapes Inc 8632 Eagle Creek Cir Savage, MN 55378	INSURER(S) AFFORDING COVERAGE		NAIC #
	INSURER A : Cincinnati Specialty Underwriters Insurance Company		13037
	INSURER B : Cincinnati Insurance Company		10677
	INSURER C : Cincinnati Casualty Company		28665
	INSURER D :		
	INSURER E :		
INSURER F :			

COVERAGES

CERTIFICATE NUMBER:

REVISION NUMBER:

THIS IS TO CERTIFY THAT THE POLICIES OF INSURANCE LISTED BELOW HAVE BEEN ISSUED TO THE INSURED NAMED ABOVE FOR THE POLICY PERIOD INDICATED. NOTWITHSTANDING ANY REQUIREMENT, TERM OR CONDITION OF ANY CONTRACT OR OTHER DOCUMENT WITH RESPECT TO WHICH THIS CERTIFICATE MAY BE ISSUED OR MAY PERTAIN, THE INSURANCE AFFORDED BY THE POLICIES DESCRIBED HEREIN IS SUBJECT TO ALL THE TERMS, EXCLUSIONS AND CONDITIONS OF SUCH POLICIES. LIMITS SHOWN MAY HAVE BEEN REDUCED BY PAID CLAIMS.

INSR LTR	TYPE OF INSURANCE	ADDL INSD	SUBR WVD	POLICY NUMBER	POLICY EFF (MM/DD/YYYY)	POLICY EXP (MM/DD/YYYY)	LIMITS
A	<input checked="" type="checkbox"/> COMMERCIAL GENERAL LIABILITY <input type="checkbox"/> CLAIMS-MADE <input checked="" type="checkbox"/> OCCUR GEN'L AGGREGATE LIMIT APPLIES PER: <input type="checkbox"/> POLICY <input checked="" type="checkbox"/> PROJECT <input type="checkbox"/> LOC OTHER:	X	X	CSU0209172	5/20/2023	5/20/2024	EACH OCCURRENCE \$ 1,000,000
							DAMAGE TO RENTED PREMISES (Ea occurrence) \$ 100,000
							MED EXP (Any one person) \$ 5,000
							PERSONAL & ADV INJURY \$ 1,000,000
							GENERAL AGGREGATE \$ 2,000,000
							PRODUCTS - COMP/OP AGG \$ 2,000,000
							\$
B	<input checked="" type="checkbox"/> AUTOMOBILE LIABILITY <input checked="" type="checkbox"/> ANY AUTO OWNED AUTOS ONLY <input type="checkbox"/> SCHEDULED AUTOS <input checked="" type="checkbox"/> HIRED AUTOS ONLY <input checked="" type="checkbox"/> NON-OWNED AUTOS ONLY			CSU0209172	6/1/2023	6/1/2024	COMBINED SINGLE LIMIT (Ea accident) \$ 1,000,000
							BODILY INJURY (Per person) \$
							BODILY INJURY (Per accident) \$
							PROPERTY DAMAGE (Per accident) \$
							\$
A	<input checked="" type="checkbox"/> UMBRELLA LIAB <input checked="" type="checkbox"/> OCCUR <input type="checkbox"/> EXCESS LIAB <input type="checkbox"/> CLAIMS-MADE DED <input checked="" type="checkbox"/> RETENTION \$ 2,500			CSU0209172	5/20/2023	5/20/2024	EACH OCCURRENCE \$ 2,000,000
							AGGREGATE \$ 2,000,000
							\$
C	WORKERS COMPENSATION AND EMPLOYERS' LIABILITY ANY PROPRIETOR/PARTNER/EXECUTIVE OFFICER/MEMBER EXCLUDED? (Mandatory in NH) <input type="checkbox"/> Y / <input type="checkbox"/> N If yes, describe under DESCRIPTION OF OPERATIONS below		X	EWC 0654880	6/1/2023	6/1/2024	PER STATUTE <input type="checkbox"/> OTH-ER <input type="checkbox"/>
							E.L. EACH ACCIDENT \$ 1,000,000
							E.L. DISEASE - EA EMPLOYEE \$ 1,000,000
							E.L. DISEASE - POLICY LIMIT \$ 1,000,000

DESCRIPTION OF OPERATIONS / LOCATIONS / VEHICLES (ACORD 101, Additional Remarks Schedule, may be attached if more space is required)

CERTIFICATE HOLDER

CANCELLATION

Midwest Playscapes, Inc
8632 Eagle Creek Circle
Savage, MN 55378

SHOULD ANY OF THE ABOVE DESCRIBED POLICIES BE CANCELLED BEFORE THE EXPIRATION DATE THEREOF, NOTICE WILL BE DELIVERED IN ACCORDANCE WITH THE POLICY PROVISIONS.

AUTHORIZED REPRESENTATIVE