



**AIA**<sup>®</sup>

# Document G701<sup>®</sup> – 2017

## Change Order

**PROJECT:** *(Name and address)*  
Williamson County  
Children's Advocacy Center  
1811 SE Inner Loop  
Georgetown, TX 78626

**CONTRACT INFORMATION:**  
Contract For: General Construction

**CHANGE ORDER INFORMATION:**  
Change Order Number: 013

Date: 11/23/2021

Date: 05/08/23

**OWNER:** *(Name and address)*  
Williamson County, Texas  
710 Main Street, Suite 101  
Georgetown, TX 78626

**ARCHITECT:** *(Name and address)*  
BLGY Architecture  
8001 Centre Park Drive, Suite 150  
Austin, TX 78754

**CONTRACTOR:** *(Name and address)*  
J. T. Vaughn Construction  
10355 Westpark Drive  
Houston, Texas 77042

**THE CONTRACT IS CHANGED AS FOLLOWS:**

*(Insert a detailed description of the change and, if applicable, attach or reference specific exhibits. Also include agreed upon adjustments attributable to executed Construction Change Directives.)*

Change Order No. 013 includes the below listed Vaughn Change Proposals No. 0027, 0028, 0030, and 0031. Additionally, a credit is included for Williamson County Utilities Invoices #1882494-52509287 and #1882494-52509296. This is deducted from Vaughn's Fee for the following Change Proposals. For Vaughn Project No. 2860-01.

- CP No. 0027 - ASI 30 Concrete Revisions	\$ 3,018.00
- CP No. 0028 - ASI 29 and ASI 37R Drainage Revisions	\$ 8,042.00
- CP No. 0030 - Signage Allowance Reconciliation	\$ 4,729.00
- CP No. 0031 - WRP Reconciliation	\$ 64,926.00

Reconcile Utilities Invoice #123028 (ref. OCO 011) \$ 837.00

The original Contract Sum was	\$ 7,749,572.00
The net change by previously authorized Change Orders	\$ 691,417.00
The Contract Sum prior to this Change Order was	\$ 8,440,989.00
The Contract Sum will be increased by this Change Order in the amount of	\$ 81,552.00
The new Contract Sum including this Change Order will be	\$ 8,522,541.00

The Contract Time will be unchanged by zero (0) days.  
The new date of Substantial Completion will be 04/20/23

**NOTE:** This Change Order does not include adjustments to the Contract Sum or Guaranteed Maximum Price, or the Contract Time, that have been authorized by Construction Change Directive until the cost and time have been agreed upon by both the Owner and Contractor, in which case a Change Order is executed to supersede the Construction Change Directive.

**NOT VALID UNTIL SIGNED BY THE ARCHITECT, CONTRACTOR AND OWNER.**

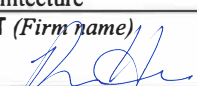
BLGY Architecture  
 ARCHITECT *(Firm name)*  
  
 SIGNATURE  
 Brody Harris, Architect  
 PRINTED NAME AND TITLE  
 5/9/23  
 DATE

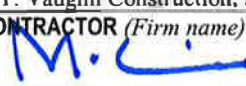
J. T. Vaughn Construction, LLC  
 CONTRACTOR *(Firm name)*  
  
 SIGNATURE  
 Mike Simpson, Director of Controls  
 PRINTED NAME AND TITLE  
 5/9/23  
 DATE

Williamson County, Texas  
 OWNER *(Firm name)*  
 SIGNATURE  
 PRINTED NAME AND TITLE  
 DATE

April 17, 2023

Brody Harris  
BLGY Architecture  
8001 Centre Park Dr. Suite 150  
Austin, TX 78754

Re: Children's Advocacy Center

Job No: 286001

Subj: Change Proposal No. 286001-0027

Dear Sir or Madam:

We respectfully submit our proposal for an increase to our contract in the amount of \$3,018 (three thousand eighteen) dollars to provide concrete revisions in accordance with ASI 30 issued by BLGY dated 12/22/22 for the above referenced project.

This proposal excludes the rubber surface play area.

Our price is valid for Fourteen (14) days

Please indicate your acceptance of this change proposal by signing and returning one copy of the attached Form B breakdown of our cost.

Very truly yours,  
VAUGHN CONSTRUCTION



Doug Boram

Attachments: Sub Back-up & ASI 030 Narrative

CC: Angel Gomez

**FORM B**

**PROJECT:** Children's Advocacy Center

**CHANGE PROPOSAL NO:** 286001-0027

**QUOTATION :**

<u>Item</u>	<u>Labor</u>	<u>Materials</u>	<u>Subs</u>	<u>Total</u>
Vaughn Construction : Fee (5.5%)	\$0.00	\$157.00	\$0.00	\$157.00
4Gen Concrete Inc (24):	\$0.00	\$0.00	\$2,861.00	\$2,861.00
<b>Totals</b>	\$0.00	\$157.00	\$2,861.00	\$3,018.00

---

**TOTAL**

**\$3,018.00**

**TIME EXTENSION TO CONTRACT:** 18 Days

**Submitted Date:** 4/18/2023

**Accepted**

**By:** \_\_\_\_\_

**Date:** \_\_\_\_\_

**VAUGHN CONSTRUCTION**

**By:**  \_\_\_\_\_  
**Doug Boran**

**Proposal Valid for 14 Days**

# 4Gen Concrete, Inc

8947 FM 2244 Rd. Suite 101  
Austin, TX 78746  
Phone: 512-263-9480  
Fax: 512-263-9487

To:  
**Clayton Coleman**  
**Vaughn Construction**

Date:  
March 2, 2023

From:  
Nathan Boltz

Project:  
**Williamson County Children's Advocacy Center**

## Change Order #9

Scope:  
Revisions to advocate and break courtyards

Deduct sidewalk and mow strip	-592.00	sf	\$5.45	-\$3,226.40
Add sidewalk and mow strip	1,117.00	sf	\$5.45	\$6,087.65
	Subtotal			\$2,861.25

*Note: Per plans CAC.ASI.30. Unit Price accounts for increased concrete price.*

---

<b>Total Bid</b>	<b>\$2,861.25</b>
------------------	-------------------

**Please sign and return this form to authorize said work to proceed.**

***Contractor has 7 days to respond to 4Gen Concrete, Inc. After which, the above quoted price will no longer be valid.***

Printed Name \_\_\_\_\_  
Title \_\_\_\_\_  
Signature \_\_\_\_\_  
Date \_\_\_\_\_

Thank you,

**Nathan Boltz**



8001 Centre Park Dr.  
 Suite 150  
 Austin, TX 78754  
 512.977.0390 t  
 512.977.0838 f  
 www.blgy.com

**ARCHITECT'S  
 SUPPLEMENTAL INSTRUCTION  
 (ASI)**

PROJECT: Wilco Children's Advocacy Center – Addition ASI NO:

**30**

PROJECT NO: 22002.0

TO: Doug Boram

DATE: 12/22/2022

This Architectural Supplemental Instruction is issued for the purpose of providing information or clarification to the Contract Documents. The work shall be carried out in accordance with the following supplemental instructions issued in accordance with the Contract Documents without change in Contract Sum or Contract Time. Indicate your acceptance of these instructions as consistent with the Contract Documents and return signed copy to the Owner and Architect.

**INSTRUCTION(S):** Landscaping and Yard area modifications

**See attached revised Architectural sheet A1.02 and A1.05**

**Also see attached revised Landscape sheets LA-0.00 and LA-1.01**

**Below are some options for the rubber play surface.**

<https://sustainablesurfacing.com/uploads/files/polystar-tumbleturf-brochure.pdf>

<https://adventureturf.com/prefabricated-rubber-playground-tiles/>

<https://www.sofsurfaces.com/durasafe>

Issued By: **BLGY, Inc.**

Accepted By:

Brody Harris/ Sita Lakshminarayan

CM Vaughn Construction

Date: \_\_\_\_\_

Copies: Angel Gomez, Project Manager

Wilco

May 08, 2023

Brody Harris  
BLGY Architecture  
8001 Centre Park Dr. Suite 150  
Austin, TX 78754

Re: Children's Advocacy Center  
Job No: 286001

Subj: Change Proposal No. 286001-0028

Dear Sir or Madam:

We respectfully submit our proposal for an increase to our contract in the amount of \$8,042 (eight thousand forty-two) dollars to provide civil drainage revisions in accordance with ASI 29 issued by BLGY on 12/15/2022 and civil grading and drainage revisions in accordance with ASI 37R issued by BLGY on 01/24/23 for the above referenced project.

It is assumed in this proposal that the scope of this work can be completed without impact to the existing contract's revised substantial completion date, 04/20/2023. If factors such as material procurement, proposal approval time, etc. cause the scope to impact substantial completion, a separate proposal will be made to claim a time extension to the contract and associated General Conditions.

Our price is valid for Fourteen (14) days

Please indicate your acceptance of this change proposal by signing and returning one copy of the attached Form B breakdown of our cost.

Very truly yours,  
VAUGHN CONSTRUCTION



Doug Boram

Attachments: Sub Back-Up, ASI 29 and 37R Narratives

CC: Angel Gomez

**FORM B**

**PROJECT:** Children's Advocacy Center

**CHANGE PROPOSAL NO:** 286001-0028

**QUOTATION :**

<u>Item</u>	<u>Labor</u>	<u>Materials</u>	<u>Subs</u>	<u>Total</u>
Texas Quality Services, LLC (25): ASI 29 Drainage Revisions	\$0.00	\$0.00	\$4,523.00	\$4,523.00
Champion Site Prep, Inc. (18): ASI 37R Grading Revisions	\$0.00	\$0.00	\$3,069.00	\$3,069.00
Vaughn Construction : Sub Default Insurance (1% of Champion)	\$0.00	\$31.00	\$0.00	\$31.00
Vaughn Construction : Fee - 5.5%	\$0.00	\$419.00	\$0.00	\$419.00

<b>Totals</b>	\$0.00	\$450.00	\$7,592.00	\$8,042.00
<b>Insurance, Tax, Benefits on Labor</b>				\$0.00
<b>Overhead</b>				\$0.00
<b>Fee on Subs</b>				\$0.00
<b>Fee on JTV</b>				\$0.00
<b>Bond</b>				\$0.00
<b>Remodel Tax</b>				\$0.00

---

**TOTAL** **\$8,042.00**

**TIME EXTENSION TO CONTRACT:** 0 Days

**Submitted Date:** 5/8/2023

**Accepted**

**By:** \_\_\_\_\_

**Date:** \_\_\_\_\_

**VAUGHN CONSTRUCTION**

**By:**  \_\_\_\_\_  
**Doug Boram**

**Proposal Valid for 14 Days**



**SUBCONTRACTOR REQUEST FOR CHANGE ORDER**

**Date:** 2/6/2023 **Subcontractor C.O. #:** 3

**Project:** Childrens Advocacy

**General Contractor:** Vaughn Construction

**TQS Contact:** Randall Reese **Phone:** 512-689-5220

In connection with our Subcontract for work to be performed at the above project, the following change has been requested.

**Description of Work or Discrepancy on Drawing:**

Added storm drain pipe not shown in civil drawings for the roof drains. Est 72 ft 6"

**Change Order Breakdown:**

**LABOR**

How many Labors	<u>1</u>	How many hours	<u>24.00</u>	Cost per hour	<u>\$35.00</u>	
How many pipe layer	<u>1</u>	How many hours	<u>12.00</u>	Cost per hour	<u>\$41.00</u>	
How many Operators	<u>1</u>	How many hours	<u>12.00</u>	Cost per hour	<u>\$43.00</u>	
How many Foreman	<u>1</u>	How many hours	<u>12.00</u>	Cost per hour	<u>\$47.00</u>	
				<b>Total Cost</b>		<u>\$2,412.00</u>

**MATERIAL**

Item: <u>pipe</u>	Cost:	<u>\$700.00</u>
Item: _____	Cost:	_____
Item: _____	Cost:	_____
Item: _____	Cost:	_____
	<b>Total Material Cost</b>	<u>\$700.00</u>

**EQUIPMENT**

Equipment Rental: <u>SKID STEER</u>	Cost:	<u>\$500.00</u>
Equipment Rental: <u>MINI EXCAVATOR</u>	Cost:	<u>\$500.00</u>
Other (describe): _____	Cost:	_____
Other (describe): _____	Cost:	_____
Other (describe): _____	Cost:	_____
Other (describe): _____	Cost:	_____
	<b>Total Miscellaneous Cost</b>	<u>\$1,000.00</u>

**Subtotal** \$4,112.00

**Overhead & Profit** 10% \$411.20

**Total Change Order Request** \$4,523.20

The conditions hereinbefore referred to are as follows:

- The aforementioned changes, and work affected thereby shall be performed under the same terms and conditions that are included in the original contract unless stated otherwise.
- This change order includes all materials, labor, tools, equipment, supervision and related taxes necessary to perform the above-mentioned work.

Submitted by: Randall Reese Title: Utility Manager Date: 2/6/2023





# CHAMPION SITE PREP

6301 N. IH 35

GEORGETOWN, TX 78633

(512) 863-3453 / WWW.IDIGDIRT.COM

## ADDITIONAL WORK / CHANGE AUTHORIZATION

[JOEY@IDIGDIRT.COM](mailto:JOEY@IDIGDIRT.COM)

ASI 37 Grading Revisions : Wilco CAC

<b>DATE:</b>	01/26/23	<b>JOB NAME:</b>	Wilco CAC
<b>TO:</b>	Vaughn Construction	<b>ESTIMATOR:</b>	JC
<b>ATTN:</b>	Clayton Coleman	<b>LOCATION:</b>	Georgetown

	DESCRIPTION	QTY	UNIT	RATE	
1.	Backhoe w/ Operator	10	HR	\$148.00	\$1,480.00
2.	Skid Steer w/ Operator	10	HR	\$131.00	\$1,310.00
<del>3.</del>	<del>Curlex (TY 2)</del>	<del>2500</del>	<del>SF</del>	<del>\$1.75</del>	<del>\$4,375.00</del>

	<b>SUBTOTAL:</b>	\$ <span style="border: 1px solid blue; padding: 2px;">2,790</span>
OH&P	1    10%	\$ <span style="border: 1px solid blue; padding: 2px;">279</span>
	<b>TOTAL:</b>	\$ <span style="border: 1px solid blue; padding: 2px;">3069</span>

Description of Work:

The scope items above include items not part of overhead including: FUEL, OIL, GREASE, MAINTENANCE, INSURANCE, SMALL TOOLS, LIGHT TRUCKS, SURVEY/CAD EQUIPMENT, AND OVERTIME IF APPLICABLE.

**NOTE:** Pricing per GC REQUEST. Scope not listed above is not included. Price is valid for 30 days.

ACCEPTANCE OF PROPOSAL- The above prices, specifications and conditions are satisfactory and are hereby accepted.

\_\_\_\_\_  
AUTHORIZED SIGNATURE

\_\_\_\_\_  
DATE OF ACCEPTANCE



8001 Centre Park Dr.  
 Suite 150  
 Austin, TX 78754  
 512.977.0390 t  
 512.977.0838 f  
 www.blgy.com

# ARCHITECT'S SUPPLEMENTAL INSTRUCTION (ASI)

PROJECT: Wilco Children's Advocacy Center – Addition ASI NO: 29  
 PROJECT NO: 22002.0  
 TO: Doug Boram DATE: 12/15/2022

This Architectural Supplemental Instruction is issued for the purpose of providing information or clarification to the Contract Documents. The work shall be carried out in accordance with the following supplemental instructions issued in accordance with the Contract Documents without change in Contract Sum or Contract Time. Indicate your acceptance of these instructions as consistent with the Contract Documents and return signed copy to the Owner and Architect.

INSTRUCTION(S): Entry Plaza Modifications

See attached revised Architectural sheet A1.03 ALT this will replace A1.03 when procing is approved.

Also see attached revised Structural sheets S2.01C and S3.13

Issued By: **BLGY, Inc.**

Accepted By:

Brody Harris/ Sita Lakshminarayan

CM Vaughn Construction

Date: \_\_\_\_\_

Copies: Angel Gomez, Project Manager

Wilco



8001 Centre Park Dr.  
 Suite 150  
 Austin, TX 78754  
 512.977.0390 t  
 512.977.0838 f  
 www.blgy.com

**ARCHITECT'S  
 SUPPLEMENTAL INSTRUCTION  
 (ASI)**

PROJECT: Wilco Children's Advocacy Center – Addition ASI NO: **37R**  
 PROJECT NO: 22002.0  
 TO: Doug Boram DATE: 1/24/2023

This Architectural Supplemental Instruction is issued for the purpose of providing information or clarification to the Contract Documents. The work shall be carried out in accordance with the following supplemental instructions issued in accordance with the Contract Documents without change in Contract Sum or Contract Time. Indicate your acceptance of these instructions as consistent with the Contract Documents and return signed copy to the Owner and Architect.

INSTRUCTION(S): **Grading Clarifications**

**See attached revised Civil sheet C 13**

Issued By: **BLGY, Inc.**

Accepted By:

Brody Harris/ Sita Lakshminarayan

CM Vaughn Construction

Date: \_\_\_\_\_

Copies: Angel Gomez, Project Manager  
Wilco

April 10, 2023

Brody Harris  
BLGY Architecture  
8001 Centre Park Dr. Suite 150  
Austin, TX 78754

Re: Children's Advocacy Center

Job No: 286001

Subj: Change Proposal No. 286001-0030

Dear Sir or Madam:

We respectfully submit our proposal for an increase to our contract in the amount of \$4,729 (four thousand seven hundred twenty-nine) dollars to provide overages to the Signage Allowance for buyout of the exterior and interior logo signage for the above referenced project.

Due to material lead times in combination with the timing of approval of the signage, the logo signage will not be completed before the project substantial completion date of 4/20/23.

Our price is valid for Fourteen (14) days

Please indicate your acceptance of this change proposal by signing and returning one copy of the attached Form B breakdown of our cost.

Very truly yours,  
VAUGHN CONSTRUCTION



Doug Beram

Attachments: Sub Back-Up

CC: Angel Gomez

**FORM B**

**PROJECT:** Children's Advocacy Center

**CHANGE PROPOSAL NO:** 286001-0030

**QUOTATION :**

<u>Item</u>	<u>Labor</u>	<u>Materials</u>	<u>Subs</u>	<u>Total</u>
Sign Resource Management, Inc. (30): Logo Signage Overage	\$0.00	\$0.00	\$4,189.00	\$4,189.00
Sign Resource Management, Inc. (30): ID Signage Changes	\$0.00	\$0.00	\$294.00	\$294.00
Vaughn Construction : Fee (5.5%)	\$0.00	\$246.00	\$0.00	\$246.00
<b>Totals</b>	\$0.00	\$246.00	\$4,483.00	\$4,729.00

---

**TOTAL**

**\$4,729.00**

**TIME EXTENSION TO CONTRACT:** 0 Days

**Submitted Date:** 4/10/2023

**Accepted**

**By:** \_\_\_\_\_

**Date:** \_\_\_\_\_

**VAUGHN CONSTRUCTION**

**By:**  \_\_\_\_\_  
**Doug Beram**

**Proposal Valid for 14 Days**



**WILCO CHILDREN'S ADVOCACY CENTER  
SIGNAGE: LOGOS EXTERIOR/INTERIOR**

**FROM: Marianne Koons  
512-863-9929 Ph/512-863-9939 Fx**

**DATE: 3-13-23**

**TO: Clayton Coleman, Vaughn Construction**

DESCRIPTION	SIZE	QTY	UNIT COST	EXTENDED TOTAL	NOTES
<b>WILCO CHILDREN'S ADVOCACY CENTER EXTERIOR/INTERIOR LOGOS</b>					
<b>EXTERIOR LOGO</b>					
Painted Aluminum w/Painted Graphics	6'0" x 6'0" x 1/4"	1	\$ 2,800.00	\$ 2,800.00	
<b>INTERIOR LOGOS</b>					
Painted Acrylic w/Painted Graphics	6'0" x 6'0" x 1/4"	2	\$ 1,950.00	\$ 3,900.00	
Installation - All above			\$ 1,295.00	\$ 1,295.00	
				\$ 7,995.00	TOTAL BUDGET - ALL LOGOS as detailed



\$3,806 (AA-02: Remainder of Signage Allowance)  
 \$4,189 (CP#30: Signage Allowance Overage)  
 \$7,995



**Wilco Children's Advocacy Center  
CO Budget Rev 1 Room Sign Changes**

**TO:** Clayton Coleman  
**EMAIL:** [W.Coleman@vaughnconstruction.com](mailto:W.Coleman@vaughnconstruction.com)  
**DATE:** March 20, 2023  
**FROM:** Marianne Koons

DESCRIPTION	SIZE	QTY	UNIT COST	EXTENDED TOTAL	NOTES
<b>Room Identification</b>					<b>Current Contract Breakdown</b>
Type I	6" x 7"	43	\$ 59.50	\$ 2,558.50	
Type II - w/insert	6" x 7"	12	\$ 77.50	\$ 930.00	Scaled Measurements - Quoted 3D SignEdge; price includes 1 color paint
Type III - Restroom	9" x 10-1/2"	8	\$ 108.00	\$ 864.00	
Additional paint colors per each		6	\$ 81.00	\$ 486.00	
		69		\$ 4,838.50	
Installation		1	\$ 875.00	\$ 875.00	
				<b>\$ 5,713.50</b>	<b>Total Room Identification</b>

DESCRIPTION	SIZE	QTY	UNIT COST	EXTENDED TOTAL	NOTES
<b>Room Identification</b>					<i>Paint color charge removed; all one color set. Budget changes per returned submittal/sign type changes.</i>
Type I	6" x 7"	8	\$ 59.50	\$ 476.00	
Type II - w/insert	6" x 7"	47	\$ 77.50	\$ 3,642.50	
Type III - Restroom	9" x 10-1/2"	8	\$ 108.00	\$ 864.00	
Backers for Glass Mounts	6" x 7"	10	\$ 15.00	\$ 150.00	
		73		\$ 5,132.50	
Installation		1	\$ 875.00	\$ 875.00	
				<b>\$ 6,007.50</b>	<b>Total Room Identification</b>
				<b>\$ 5,713.50</b>	<b>Total in Current Contract/Room Signs</b>
				<b>\$ 294.00</b>	<b>CO ADD for Sign Changes</b>

May 08, 2023

Brody Harris  
BLGY Architecture  
8001 Centre Park Dr. Suite 150  
Austin, TX 78754

Re: Children's Advocacy Center

Job No: 286001

Subj: Change Proposal No. 286001-0031

Dear Sir or Madam:

We respectfully submit our proposal for an increase to our contract in the amount of \$64,926 (sixty-four thousand nine hundred twenty-six) dollars to provide WRP Reconciliation for the above referenced project.

This change proposal is for reconciliation of WRP revisions. The railing, column wraps, and sound masking scope additions/revisions are expected to be complete after the substantial completion date, 4/20/23. There are no claims for additional days or general conditions in this proposal.

Our price is valid for Fourteen (14) days

Please indicate your acceptance of this change proposal by signing and returning one copy of the attached Form B breakdown of our cost.

Very truly yours,  
VAUGHN CONSTRUCTION



Doug Boram

Attachments: Sub Back-Up

CC: Angel Gomez



**FORM B****PROJECT: Children's Advocacy Center****CHANGE PROPOSAL NO: 286001-0031****QUOTATION :**

<u>Item</u>	<u>Labor</u>	<u>Materials</u>	<u>Subs</u>	<u>Total</u>
MIL, Ltd. (1001): CP #12 - SE Step Rails	\$0.00	\$0.00	\$1,740.00	\$1,740.00
MIL, Ltd. (1001): CP #13 - Plaza Trough	\$0.00	\$0.00	\$2,002.00	\$2,002.00
Jewel's Commercial Cleaning, LLC (1): CP #1 - Final Clean Additions	\$0.00	\$0.00	\$2,970.00	\$2,970.00
Empire Acero, LLC (3): CP #10 - Steel Modifications	\$0.00	\$0.00	\$1,115.00	\$1,115.00
The Glass House, Inc. (7): CP #7 - Additional Flashing	\$0.00	\$0.00	\$1,998.00	\$1,998.00
Standard Drywall, Inc. (8): CP #20 - Sun Shade Clip Install	\$0.00	\$0.00	\$12,816.00	\$12,816.00
Standard Drywall, Inc. (8): CP #21/30/31 - Miscellaneous Drywall Revisions	\$0.00	\$0.00	\$4,115.00	\$4,115.00
Standard Drywall, Inc. (8): CP #43 - Large Conference Room Cloud Ceiling Revision	\$0.00	\$0.00	\$849.00	\$849.00
Standard Drywall, Inc. (8): CP #44 - RFI 61 Grid Revisions	\$0.00	\$0.00	\$425.00	\$425.00
Central Texas Finishers, LLC (11): CP #11 - Clear Seal Interview Frames	\$0.00	\$0.00	\$237.00	\$237.00
Central Texas Finishers, LLC (11): CP #12 - Paint Window Sills	\$0.00	\$0.00	\$329.00	\$329.00
DRP Group, LLC (12): CP #20 - Toilet Partition Revisions	\$0.00	\$0.00	\$1,980.00	\$1,980.00
Doyle Electric, LLC (15): CP #19 - Motorized Shade Circuit	\$0.00	\$0.00	\$582.00	\$582.00
Doyle Electric, LLC (15): CP #20/21 - Additional Pathways	\$0.00	\$0.00	\$1,909.00	\$1,909.00
Doyle Electric, LLC (15): CP #22 - Upsize Water Heater Breaker	\$0.00	\$0.00	\$1,580.00	\$1,580.00
Doyle Electric, LLC (15): CP #23 - Refeed AC Unit	\$0.00	\$0.00	\$261.00	\$261.00
Doyle Electric, LLC (15): CP #25 - Additional Fire Alarm Pathway	\$0.00	\$0.00	\$340.00	\$340.00
Britt Rice Construction Company, L.P. (16): CP #4 - Sound Masking	\$0.00	\$0.00	\$7,859.00	\$7,859.00
A K Fuquay Construction (19): CP #2 - Construction Entrance Credit	\$0.00	\$0.00	\$(1,350.00)	\$(1,350.00)
Red & White Greenery, Inc. (20): CP #5 - Additional Bed Excavation	\$0.00	\$0.00	\$3,000.00	\$3,000.00
Red & White Greenery, Inc. (20): CP #6 - Gates and Hinges	\$0.00	\$0.00	\$9,296.00	\$9,296.00
Texas Traditions Group, LLC (26): CP #7 - Column Wraps	\$0.00	\$0.00	\$11,883.00	\$11,883.00

# FORM B

**PROJECT:** Children's Advocacy Center

**CHANGE PROPOSAL NO:** 286001-0031

**QUOTATION :**

<u>Item</u>	<u>Labor</u>	<u>Materials</u>	<u>Subs</u>	<u>Total</u>
Waterproofers, LLC (27): CP #9 - Sun Shade Clip Flashing	\$0.00	\$0.00	\$2,387.00	\$2,387.00
Waterproofers, LLC (27): CP #10 - Caulk Doors	\$0.00	\$0.00	\$1,190.00	\$1,190.00
Waterproofers, LLC (27): CP #11 - Caulk Brick to Hardie	\$0.00	\$0.00	\$2,502.00	\$2,502.00
Vaughn Construction : Fee - 5.5% of items after WRP Reconciliation Deduction	\$0.00	\$3,384.00	\$0.00	\$3,384.00
Vaughn Construction : WRP Reconciliation	\$0.00	\$(11,106.00)	\$0.00	\$(11,106.00)
Southwest Geo-Solutions, Inc (21): Additional SWPPP Inspection	\$0.00	\$0.00	\$300.00	\$300.00
Vaughn Construction : Sub Default Insurance (1.25% of SDI, Myrex, and Doyle)	\$0.00	\$333.00	\$0.00	\$333.00

<b>Totals</b>	\$0.00	\$(7,389.00)	\$72,315.00	\$64,926.00
				<b>Insurance, Tax, Benefits on Labor</b>
				\$0.00
				<b>Overhead</b>
				\$0.00
				<b>Fee on Subs</b>
				\$0.00
				<b>Fee on JTV</b>
				\$0.00
				<b>Bond</b>
				\$0.00
				<b>Remodel Tax</b>
				\$0.00

---

**TOTAL** **\$64,926.00**

**TIME EXTENSION TO CONTRACT:** 0 Days

**Submitted Date:** 5/8/2023

**Accepted**

**VAUGHN CONSTRUCTION**

By: \_\_\_\_\_

By:   
 \_\_\_\_\_  
**Doug Beran**

Date: \_\_\_\_\_

**Proposal Valid for 14 Days**

# INVOICE

**Jewel's Commercial Cleaning, LLC.**  
4730 Shavano Oak Suite #211  
San Antonio, TX 78249

julia@jccml.us  
(210) 888-6130



## Vaughn Construction - SA

**Bill to**  
Vaughn Construction - SA  
1400 Universal City Blvd, Universal  
City, TX 78148

**Invoice details**  
**Change Order 001 - Additional Clean**

Product or service	Amount
1. <b>Cleaning Fee</b> Wilco CAC - Final Clean - Crew of 8 - Final Clean: Broom Clean of all exposed hard and resilient floors. Clean all architectural woodwork. Clean all doors and polish hardware. Clean all walls, electrical fixtures, switches, wall outlets, light fixtures, wall vents, grills, diffusers, and registers. Vacuum all carpeted areas. Clean all toilets, sink fixtures, dispensers, and accessories. Clean finishes free of dust, stains, films and other foreign substances. Polish reflective surfaces to clear shine. Clean all window sills, windows, and frames.	1 unit × \$2,700.00 \$2,700.00
2. <b>OH&amp;P</b> 10%	1 unit × \$270.00 \$270.00
<b>Total</b>	<b>\$2,970.00</b>



## T&M Ticket #4

<b>Performed on</b>	Mar 22, 2023	<b>Reference #</b>	
<b>Status</b>	Closed	<b>Ordered by</b>	Shawn Baggett (Vaughn Construction)
<b>Description</b>	Redrilling holes into the sunshade frames to match existing wall clips.		

### Labor (2)

Employee	Hours
John Carter (Empire Steel Erectors, L.P.)	6.0
Chason Carter (Empire Steel Erectors, L.P.)	6.0
<b>Total:</b>	12.0

### Equipment (1)

Equipment	Description	Unit	Quantity
Rig Truck		hours	6.0
<b>Total:</b>			6.0

### Attachments



[3F67D2B5-7D90-4044-87A2-4B728257F135.jpg](#)



[651267C9-1C97-4C1B-9442-2BB6EFAC0164.jpg](#)



[58445E6A-5C74-4AE4-A460-6AAB2D1E3D82.jpg](#)



[CECBD046-269E-49A1-9486-2BB6494050AC.jpg](#)



[C6C09949-BFD7-4647-82EF-DE93FB30F9E2.jpg](#)



[A0B5705F-7E68-49F1-B162-61EE587BB180.jpg](#)

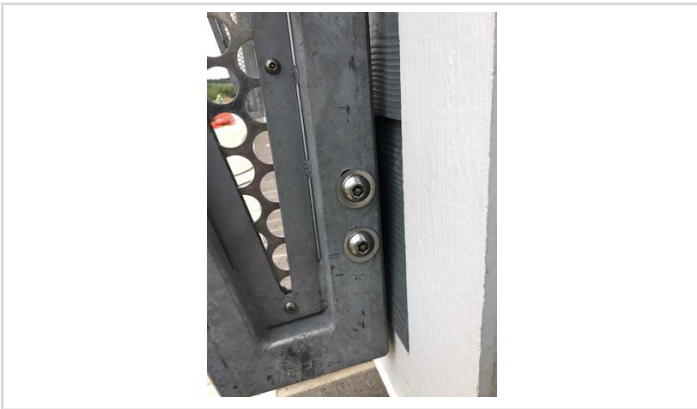

[7236613E-8C37-43E5-96A0-38EFDD1018E6.jpg](#)



[EB13C9E3-8F8E-4EA9-AA96-04788839FE63.jpg](#)



[DCE4697A-D73B-43ED-8111-E4F75F2840CF.jpg](#)



[D4E09A38-CB30-4EEF-A067-6B5EE8F796CF.jpg](#)

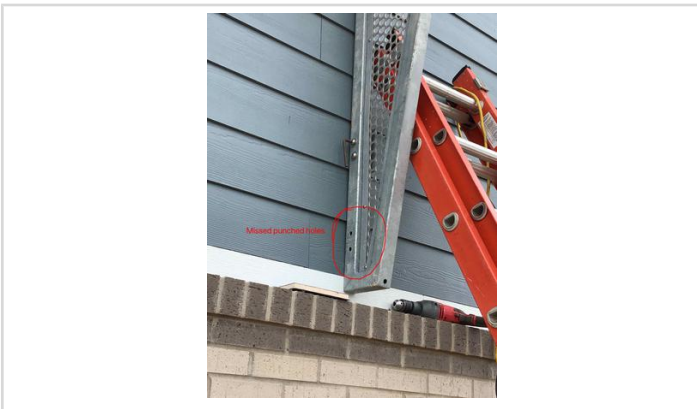

[9FA83B9E-4FE4-4EA6-8B0B-30FF0AD4B719.jpg](#)



[35DB24EC-A0D5-4602-9C29-795E5B523E67.jpg](#)

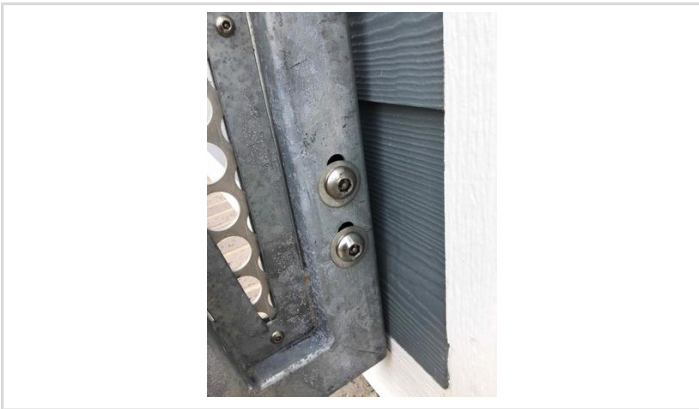

[72B7D3F6-D8B9-4FE2-9711-DD8A1D1DDAA0.jpg](#)

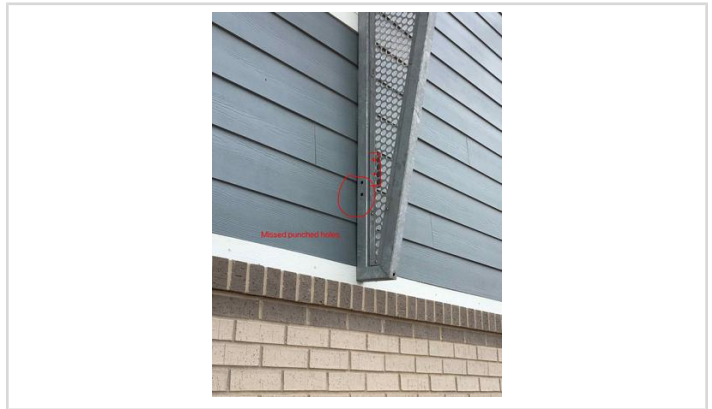

[8426CC4C-7B0E-47FC-A894-339B1A695F03.jpg](#)



[1970F1E4-5008-49D2-94E4-D1753995205C.jpg](#)



[979A3938-B555-4076-B776-B686FF00E425.jpg](#)



[596EA32F-94C0-4BFD-AC39-4F713C2C710B.jpg](#)

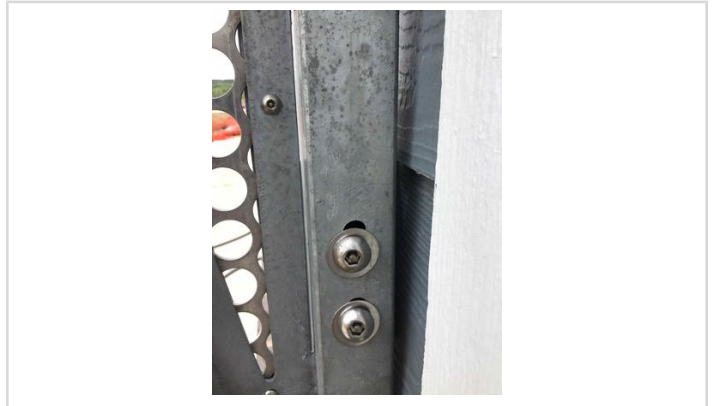

[6870659E-22BC-483D-B3CB-8650E2F78388.jpg](#)

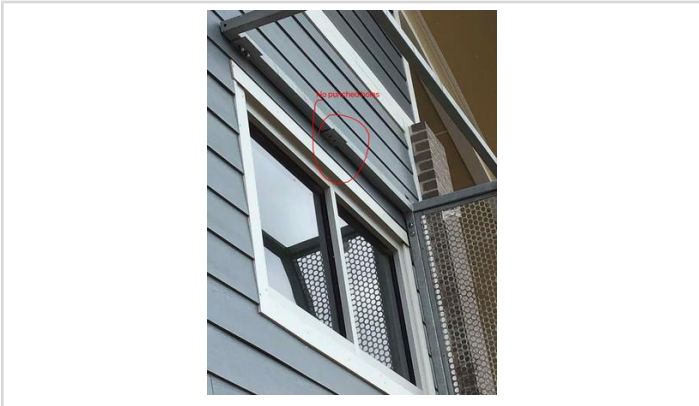

[913800BD-C392-4D07-B901-E486F9517774.jpg](#)

**Approvals**



Mar 29, 2023

**COMPANY SIGNATURE**  
John Carter  
Empire Steel Erectors, L.P.

**DATE**



Mar 29, 2023

**CUSTOMER SIGNATURE**  
Shawn Baggett  
Vaughn Construction

**DATE**

**Notes**





5Mar2023

**JOB: Vaughn Construction/Children's Advocacy Center  
286001-0007**

**RE: Supply Head and Sill Flashing  
TGH COR #07**

GENTLEMEN:

**PLEASE ISSUE A CHANGE ORDER TO OUR CONTRACT TO MAKE CHANGES AS FOLLOWS:**

- Per Vaughn's request via email on 2/18/2023. Supply additional brake metal flashings.

***Oscar,***

***I need 10 more pieces of flashing. Several pieces get damaged and these are critical to getting the exterior skin completed. If you could have them expedited that would be appreciated. Feel free to call with any questions.***

**QUALIFICATIONS:**

- Includes (+/-) 100 LF of .050 brake metal matching storefront finish.
- Supply only – no installation labor.
- Material to be supplied bent in 120" long pieces.
- Please allow 2-3 Weeks lead times for material after COR has been approved and the order has been released. (Keep in mind lead times might extend as we have seen due to historical material supply)

**COR TOTAL**

**\$1,998.00**

ALL OTHER TGH PROPOSAL TERMS AND CONDITIONS REMAIN UNCHANGED

**\*\*\*\*Due to historic material supply conditions this change order pricing is good for ten (10) days from proposal date\*\*\*\***

QUESTIONS CONCERNING THIS COR SHOULD BE DIRECTED TO:

**Abraham Davalos**

The Glass House, Inc.

El Paso / Austin

915-704-0042 cell

[adavalos@glasshousetexas.com](mailto:adavalos@glasshousetexas.com)



# REQUEST FOR CHANGE ORDER

Ref.# TX8013-020

External/RCO#

GC Ref#

Date Oct 25, 2022

Job # TX8013

**To: VAUGHN CONSTRUCTION**  
 10355 WESTPARK DRIVE  
 HOUSTON, TX 77042  
 Phone: (281) 808-7772 Fax: (713) 243-8350

**Project: WILCO CHILDREN'S ADVOCACY CENTER**  
 1811 S.E. Inner Loop  
 Georgetown, TX 78626

**Contact: Doug Boram**

Description: Sunshade clip install

Labor	Phase	Cost Code	Quantity UOM	Unit Total	Rate	Total
General Foreman	00	501	16.00 Hrs	16.00	50.00	\$800.00
Extra Work	00	511	236.00 Hrs	236.00	42.00	\$9,912.00
<b>Total Labor</b>						<b>\$10,712.00</b>

Material	Phase	Cost Code	Size	Quantity UOM	Unit Price	Total
6" STUD 1 5/8" FLANGE (68 MIL) 14GA G90		601	12'	5.00 PCS	6,930.00 MLF	\$415.80
<b>Total Material</b>						<b>\$415.80</b>

Equipment	Phase	Cost Code	Quantity UOM	Unit Price	Total
40' ARTICULATING BOOM-2WD ELEC - JLG E400AJPN - Genie Z-40/23N	00	750	0.50 EA	1,050.00 EA	\$525.00
<b>Total Equipment</b>					<b>\$525.00</b>

**AUTHORIZED BY: Doug Boram**  
**ON BEHALF OF: VAUGHN CONSTRUCTION**  
**PROJECT MANAGER: JEREMY A RIDDLE**  
**ESTIMATOR: TRENT E PATTESON**

<b>Labor Total:</b>	<b>\$10,712.00</b>
<b>Material Total:</b>	<b>\$415.80</b>
<b>Sub Trade Total:</b>	<b>\$0.00</b>
<b>Cleanup Total:</b>	<b>\$0.00</b>
<b>Equipment Total:</b>	<b>\$525.00</b>
<b>Misc. Total:</b>	<b>\$0.00</b>
<b>Sub Total:</b>	<b>\$11,652.80</b>
<b>Mark Up:</b>	<b>\$1,163.20 9.98%</b>
<b>Total:</b>	<b>\$12,816.00</b>

STANDARD DRYWALL, INC.  
EXTRA WORK AUTHORIZATION

63967

JOB NO. T-8013	JOB NAME Wilco CAC	CUSTOMER Vaughn	AUTH TO PROCEED	START DATE 12/17/22	FINISH DT 1-7-23
-------------------	-----------------------	--------------------	-----------------	------------------------	---------------------

DESCRIPTION OF WORK:  
Der request of Shawn B SDI worked installing sun shade clips. all this including 2 saturday's 12-17-22 and 1-7-23

MATERIAL		LABOR							
QTY	DESCRIPTION	TRADE	R	OT	DT	PT	DP	RATE	AMOUNT
		SUPERVISION	16						
310	5-0D10-18 x 3/4	CARPENTER	23%						
5	5 p.s 605125-68 x 12'	TAPER							
220	1-1/4 Self tapes	LATHER							
		PLASTERER							
		HODCARRIER							
		LABORER							
SUBTOTAL									
SALES TAX @ %									
TOTAL MATERIAL COST		TOTAL LABOR COST							

MISCELLANEOUS			SUMMARY	
QTY	DESCRIPTION	AMOUNT	DESCRIPTION	AMOUNT
	TRUCKING		TOTAL MATERIAL	
	EQUIPMENT RENTAL		TOTAL LABOR	
1	boom lift 40'		TOTAL MISCELLANEOUS	
1	2790RT		OVERHEAD & PROFIT	
			BOND	
TOTAL MISCELLANEOUS COST			GRAND TOTAL	

AUTHORIZED BY <i>S. Baucett</i>	CUSTOMER WORK AUTHORIZATION NO.	SDI REPRESENTATIVE Diego C
COMPANY Vaughn	WORK TO BE CONTINUED? YES <input type="checkbox"/> NO <input type="checkbox"/>	PRINT Diego C
IF YES, CONTINUED ON EWA NO.		



# REQUEST FOR CHANGE ORDER

Ref.# TX8013-021

External/RCO#

GC Ref#

Date Oct 26, 2022

Job # TX8013

**To: VAUGHN CONSTRUCTION**

10355 WESTPARK DRIVE

HOUSTON, TX 77042

Phone: (281) 808-7772 Fax: (713) 243-8350

**Project: WILCO CHILDREN'S ADVOCACY CENTER**

1811 S.E. Inner Loop

Georgetown, TX 78626

**Contact: Doug Boram****Description: RFI 77 - revisions to get existing wall and new wall at Room 169 to align**

Labor	Phase	Cost Code	Quantity UOM	Unit Total	Rate	Total
General Foreman	00	501	2.00 Hrs	2.00	50.00	\$100.00
Cleanup All	00	507	1.00 Hrs	1.00	42.00	\$42.00
Stocking	00	508	1.00 Hrs	1.00	42.00	\$42.00
Frame All	02	155	4.00 Hrs	4.00	42.00	\$168.00
Demolition	02	184	12.00 Hrs	12.00	42.00	\$504.00
<b>Total Labor</b>						<b>\$856.00</b>

Material	Phase	Cost Code	Size	Quantity UOM	Unit Price	Total
5/8" TYPE "X" DRYWALL X58	00	600	4'X10'	2.00 SHT	.378 SQFT	\$30.24
4" STUD 1 1/4" FLANGE (33 MIL) 20GA	00	600	10'	5.00 PCS	1.7115 FT	\$85.58
<b>Total Material</b>						<b>\$115.82</b>

**AUTHORIZED BY: Doug Boram**  
**ON BEHALF OF: VAUGHN CONSTRUCTION**  
**PROJECT MANAGER: JEREMY A RIDDLE**  
**ESTIMATOR: TRENT E PATTESON**

<b>Labor Total:</b>	<b>\$856.00</b>
<b>Material Total:</b>	<b>\$115.82</b>
<b>Sub Trade Total:</b>	<b>\$0.00</b>
<b>Cleanup Total:</b>	<b>\$0.00</b>
<b>Equipment Total:</b>	<b>\$0.00</b>
<b>Misc. Total:</b>	<b>\$0.00</b>
<b>Sub Total:</b>	<b>\$971.82</b>
<b>Markup:</b>	<b>\$97.18 10.00%</b>
<b>Total:</b>	<b>\$1,069.00</b>



# REQUEST FOR CHANGE ORDER

Ref.# TX8013-030

External/RCO#

GC Ref#

Date Jan 02, 2023

Job # TX8013

**To: VAUGHN CONSTRUCTION**  
 10355 WESTPARK DRIVE  
 HOUSTON, TX 77042  
 Phone: (281) 808-7772 Fax: (713) 243-8350

**Project: WILCO CHILDREN'S ADVOCACY CENTER**  
 1811 S.E. Inner Loop  
 Georgetown, TX 78626

**Contact: Doug Boram**

Description: Replace drywall in room #122

Labor	Phase	Cost Code	Quantity UOM	Unit Total	Rate	Total
General Foreman	00	501	1.00 Hrs	1.00	50.00	\$50.00
Extra Work	00	511	8.00 Hrs	8.00	42.00	\$336.00
<b>Total Labor</b>						<b>\$386.00</b>

Material	Phase	Cost Code	Size	Quantity UOM	Unit Price	Total
GOLD BOND MOISTURE RESISTANT XP 5/8"			4'X8'	4.00 SHT	.4725 SQFT	\$60.48
<b>Total Material</b>						<b>\$60.48</b>

**AUTHORIZED BY: Doug Boram**  
**ON BEHALF OF: VAUGHN CONSTRUCTION**  
**PROJECT MANAGER: JEREMY A RIDDLE**  
**ESTIMATOR: TRENT E PATTESON**

<b>Labor Total:</b>	<b>\$386.00</b>
<b>Material Total:</b>	<b>\$60.48</b>
<b>Sub Trade Total:</b>	<b>\$0.00</b>
<b>Cleanup Total:</b>	<b>\$0.00</b>
<b>Equipment Total:</b>	<b>\$0.00</b>
<b>Misc. Total:</b>	<b>\$0.00</b>
<b>Sub Total:</b>	<b>\$446.48</b>
<b>Mark Up:</b>	<b>\$44.52 9.97%</b>
<b>Total:</b>	<b>\$491.00</b>

STANDARD DRYWALL, INC.  
EXTRA WORK AUTHORIZATION

63965

JOB NO. Tx 8013	JOB NAME Wilco C.A.	CUSTOMER Vaughn	AUTH TO PROCEED	START DATE 12-12-22	FINISH DT 12-12-22
--------------------	------------------------	--------------------	-----------------	------------------------	-----------------------

DESCRIPTION OF WORK:  
 Per request of Vaughn. SDI replace drywall  
 at room #122 (Mold tough)

MATERIAL		LABOR							
QTY	DESCRIPTION	TRADE	R	OT	DT	PT	DP	RATE	AMOUNT
		SUPERVISION	1						
4 pcs	4'x8'x 5/8 mold tough	CARPENTER	8						
200	1-1/2" drywall screws	TAPER							
		LATHER							
		PLASTERER							
		HODCARRIER							
		LABORER							
SUBTOTAL									
SALES TAX @ %									
TOTAL MATERIAL COST		TOTAL LABOR COST							

MISCELLANEOUS			SUMMARY	
QTY	DESCRIPTION	AMOUNT	DESCRIPTION	AMOUNT
	TRUCKING		TOTAL MATERIAL	
	EQUIPMENT RENTAL		TOTAL LABOR	
			TOTAL MISCELLANEOUS	
			OVERHEAD & PROFIT	
			BOND	
TOTAL MISCELLANEOUS COST			GRAND TOTAL	

AUTHORIZED BY <i>S. B. [Signature]</i>	CUSTOMER WORK AUTHORIZATION NO.	SDI REPRESENTATIVE <i>Diego C</i>
COMPANY Vaughn	WORK TO BE CONTINUED? YES <input type="checkbox"/> NO <input checked="" type="checkbox"/>	PRINT <i>Diego C</i>
IF YES, CONTINUED ON EWA NO.		



# REQUEST FOR CHANGE ORDER

Ref.# TX8013-031

External/RCO#

GC Ref#

Date Jan 02, 2023

Job # TX8013

**To: VAUGHN CONSTRUCTION**  
 10355 WESTPARK DRIVE  
 HOUSTON, TX 77042  
 Phone: (281) 808-7772 Fax: (713) 243-8350

**Project: WILCO CHILDREN'S ADVOCACY CENTER**  
 1811 S.E. Inner Loop  
 Georgetown, TX 78626

**Contact: Doug Boram**

Description: EWA 63966 - RFI 88R1

Labor	Phase	Cost Code	Quantity UOM	Unit Total	Rate	Total
General Foreman	00	501	3.00 Hrs	3.00	50.00	\$150.00
Extra Work	00	511	26.00 Hrs	26.00	42.00	\$1,092.00
<b>Total Labor</b>						<b>\$1,242.00</b>

Material	Phase	Cost Code	Size	Quantity UOM	Unit Price	Total
1" SHAFTWALL LINER USG MOLDTOUGH	00	600	10'	2.00 EA	1.2075 SQFT	\$48.30
<b>Total Material</b>						<b>\$48.30</b>

**AUTHORIZED BY: Doug Boram**  
**ON BEHALF OF: VAUGHN CONSTRUCTION**  
**PROJECT MANAGER: JEREMY A RIDDLE**  
**ESTIMATOR: TRENT E PATTESON**

<b>Labor Total:</b>	<b>\$1,242.00</b>
<b>Material Total:</b>	<b>\$48.30</b>
<b>Sub Trade Total:</b>	<b>\$0.00</b>
<b>Cleanup Total:</b>	<b>\$0.00</b>
<b>Equipment Total:</b>	<b>\$0.00</b>
<b>Misc. Total:</b>	<b>\$0.00</b>
<b>Sub Total:</b>	<b>\$1,290.30</b>
<b>Mark Up:</b>	<b>\$128.70 9.97%</b>
<b>Total:</b>	<b>\$1,419.00</b>

STANDARD DRYWALL, INC.  
EXTRA WORK AUTHORIZATION

63966

JOB NO.	JOB NAME	CUSTOMER	AUTH TO PROCEED	START DATE	FINISH DT
Ty 8013	Wilco C AC	Vaughn		12-5-22	12-19-22

DESCRIPTION OF WORK:

Per request of shawn B. From Vaughn  
SDT Fixed shaft wall Per RFI #88R1

MATERIAL			LABOR							
QTY	DESCRIPTION		TRADE	R	OT	DT	PT	DP	RATE	AMOUNT
10 pcs	<del>2" steel pins</del>		SUPERVISION	3						
2 pcs	2'x10'x1" shaft liner		CARPENTER	26						
30 pcs	1-3/8 self tapers		TAPER							
			LATHER							
			PLASTERER							
			HODCARRIER							
			LABORER							
SUBTOTAL										
SALES TAX @ %										
TOTAL MATERIAL COST			TOTAL LABOR COST							

MISCELLANEOUS			SUMMARY	
QTY	DESCRIPTION	AMOUNT	DESCRIPTION	AMOUNT
	TRUCKING		TOTAL MATERIAL	
	EQUIPMENT RENTAL		TOTAL LABOR	
			TOTAL MISCELLANEOUS	
			OVERHEAD & PROFIT	
			BOND	
TOTAL MISCELLANEOUS COST			GRAND TOTAL	

AUTHORIZED BY <i>S. Barnett</i> COMPANY Vaughn	CUSTOMER WORK AUTHORIZATION NO.	SDI REPRESENTATIVE Diego C PRINT Diego C.
WORK TO BE CONTINUED?	YES <input type="checkbox"/> NO <input checked="" type="checkbox"/>	
IF YES, CONTINUED ON EWA NO.		





# REQUEST FOR CHANGE ORDER

Ref.# TX8013-043

External/RCO#

GC Ref#

Date Mar 21, 2023

Job # TX8013

**To: VAUGHN CONSTRUCTION**  
 10355 WESTPARK DRIVE  
 HOUSTON, TX 77042  
 Phone: (281) 808-7772 Fax: (713) 243-8350

**Project: WILCO CHILDREN'S ADVOCACY CENTER**  
 1811 S.E. Inner Loop  
 Georgetown, TX 78626

**Contact: Doug Boram**

**Description: Move upper ceiling cloud in conference room**

Labor	Phase	Cost Code	Quantity UOM	Unit Total	Rate	Total
General Foreman	00	501	2.00 Hrs	2.00	50.00	\$100.00
Extra Work	00	511	16.00 Hrs	16.00	42.00	\$672.00
<b>Total Labor</b>						<b>\$772.00</b>

**AUTHORIZED BY: Doug Boram**  
**ON BEHALF OF: VAUGHN CONSTRUCTION**  
**PROJECT MANAGER: JEREMY A RIDDLE**  
**ESTIMATOR: TRENT E PATTESON**

<b>Labor Total:</b>	<b>\$772.00</b>
<b>Material Total:</b>	<b>\$0.00</b>
<b>Sub Trade Total:</b>	<b>\$0.00</b>
<b>Cleanup Total:</b>	<b>\$0.00</b>
<b>Equipment Total:</b>	<b>\$0.00</b>
<b>Misc. Total:</b>	<b>\$0.00</b>
<b>Sub Total:</b>	<b>\$772.00</b>
<b>Mark Up:</b>	<b>\$77.00 9.97%</b>
<b>Total:</b>	<b>\$849.00</b>

STANDARD DRYWALL, INC.  
EXTRA WORK AUTHORIZATION

63973

JOB NO. Tx 803	JOB NAME Wilco c/c	CUSTOMER Vaughn	AUTH TO PROCEED	START DATE 2-11-23	FINISH DT 2-11-23
-------------------	-----------------------	--------------------	-----------------	-----------------------	----------------------

DESCRIPTION OF WORK:

At the request of Shawn B. SDI moved the upper ceiling clouds at the large conference room

MATERIAL		LABOR							
QTY	DESCRIPTION	TRADE	R	OT	DT	PT	DP	RATE	AMOUNT
		SUPERVISION	2						
		CARPENTER	16						
		TAPER							
		LATHER							
		PLASTERER							
		HODCARRIER							
		LABORER							
SUBTOTAL									
SALES TAX @ %									
TOTAL MATERIAL COST		TOTAL LABOR COST							

MISCELLANEOUS			SUMMARY	
QTY	DESCRIPTION	AMOUNT	DESCRIPTION	AMOUNT
	TRUCKING		TOTAL MATERIAL	
	EQUIPMENT RENTAL		TOTAL LABOR	
			TOTAL MISCELLANEOUS	
			OVERHEAD & PROFIT	
			BOND	
TOTAL MISCELLANEOUS COST			GRAND TOTAL	

AUTHORIZED BY S. Byatt S. BALLETT	CUSTOMER WORK AUTHORIZATION NO.	SDI REPRESENTATIVE Diego C
COMPANY Vaughn	WORK TO BE CONTINUED? YES <input type="checkbox"/> NO <input checked="" type="checkbox"/>	PRINT Diego C
IF YES, CONTINUED ON EWA NO.		



# REQUEST FOR CHANGE ORDER

Ref.# TX8013-044

External/RCO#

GC Ref#

Date Mar 21, 2023

Job # TX8013

**To: VAUGHN CONSTRUCTION**

10355 WESTPARK DRIVE

HOUSTON, TX 77042

Phone: (281) 808-7772 Fax: (713) 243-8350

**Project: WILCO CHILDREN'S ADVOCACY CENTER**

1811 S.E. Inner Loop

Georgetown, TX 78626

**Contact: Doug Boram**

Description: EWA 64277 - RFI 61

Labor	Phase	Cost Code	Quantity UOM	Unit Total	Rate	Total
General Foreman	00	501	1.00 Hrs	1.00	50.00	\$50.00
Extra Work	00	511	8.00 Hrs	8.00	42.00	\$336.00
<b>Total Labor</b>						<b>\$386.00</b>

**Labor Total: \$386.00****Material Total: \$0.00****Sub Trade Total: \$0.00****Cleanup Total: \$0.00****Equipment Total: \$0.00****Misc. Total: \$0.00****Sub Total: \$386.00****Mark Up: \$39.00 10.10%**

<b>Total:</b>	<b>\$425.00</b>
---------------	-----------------

**AUTHORIZED BY: Doug Boram****ON BEHALF OF: VAUGHN CONSTRUCTION****PROJECT MANAGER: JEREMY A RIDDLE****ESTIMATOR: TRENT E PATTESON**





**CENTRAL TEXAS FINISHERS**  
QUALITY. ON TIME!

8534 Apache Rd. Converse Texas 78109  
Project Manager- Enrique Sapien  
[es@centraltexasfinishers.com](mailto:es@centraltexasfinishers.com)  
915.249.5678

**T&M Estimate**

Project Name: WILCO CHILDRENS ADVOCACY CENTER Date: 4/5/2023  
Contractor Name: CTF Change No. \_\_\_\_\_  
Description: WINDOW FRAME SEALER

Item #	Description	Quantity	Unit	Unit Cost	Labor	Material & Equipment	Equipment
<b>Labor</b>							
	BENJAMIN SANCHEZ	6.0	HR	\$ 25.11	\$ 151		
	5-Apr		HR		\$ -		
			HR		\$ -		
			HR		\$ -		
<b>Materials</b>							
	MINWAX CLEAR PU WOOD SEALER SG	1.0	GL	\$ 64.85		\$ 64.85	
						\$ -	
						\$ -	
						\$ -	
						\$ -	
						\$ -	
						\$ -	
<b>Equipment</b>							
							\$ -
							\$ -
							\$ -
							\$ -
							\$ -
							\$ -

**SUBTOTAL** \$ 150.66 \$ 64.85 \$ -  
\$ 215.51

<b>Overhead and Profit (15% for up to \$10,000 Subtotal)</b>	<b>SUBTOTAL</b>	\$ 215.51
10.0%		\$ 21.55
<b>Overhead and Profit (10% for \$10,000 - \$20,000 Subtotal)</b>	<b>SUBTOTAL</b>	\$ -
10.0%		\$ -
<b>Overhead and Profit (7.5% for over \$20,000 Subtotal)</b>	<b>SUBTOTAL</b>	\$ -
7.5%		\$ -

**TOTAL FOR THIS CHANGE PROPOSAL** \$ **237.06**



**CENTRAL TEXAS FINISHERS**  
QUALITY. ON TIME!

8534 Apache Rd. Converse Texas 78109  
Project Manager- Enrique Sapien  
[es@centraltexasfinishers.com](mailto:es@centraltexasfinishers.com)  
915.249.5678

**T&M Estimate**

Project Name: WILCO CHILDRENS ADVOCACY CENTER Date: 4/6/2023  
Contractor Name: CTF Change No. \_\_\_\_\_  
Description: WINDOW SILL PAINT

Item #	Description	Quantity	Unit	Unit Cost	Labor	Material & Equipment	Equipment
<b>Labor</b>							
	GILBERT MARTINEZ JR		HR		\$ -		
	5-Apr	3.0	HR	\$ 25.11	\$ 75		
	6-Apr	4.0	HR	\$ 25.11	\$ 100		
			HR		\$ -		
<b>Materials</b>							
	SW EXTREME BOND PRIMER	1.0	GL	\$ 55.99		\$ 55.99	
	SW PROMAR 200 LOW VOC INTERIOR PAINT	1.0	GL	\$ 67.99		\$ 67.99	
						\$ -	
						\$ -	
						\$ -	
						\$ -	
						\$ -	
<b>Equipment</b>							
							\$ -
							\$ -
							\$ -
							\$ -
							\$ -

**SUBTOTAL** \$ 175.77 \$ 123.98 \$ -  
\$ 299.75

<b>Overhead and Profit (15% for up to \$10,000 Subtotal)</b>	<b>SUBTOTAL</b>	\$ 299.75
10.0%		\$ 29.98
<b>Overhead and Profit (10% for \$10,000 - \$20,000 Subtotal)</b>	<b>SUBTOTAL</b>	\$ -
10.0%		\$ -
<b>Overhead and Profit (7.5% for over \$20,000 Subtotal)</b>	<b>SUBTOTAL</b>	\$ -
7.5%		\$ -

**TOTAL FOR THIS CHANGE PROPOSAL** \$ 329.73

**Southern Specialty & Accessory, LLC**

4250 Cedarbrush Drive • Dallas, Texas 75229 • 214-470-5821

MBE Certification #HMMB92903N1019 • HUB Certification #1463618387400 • DBE Certification #HMDB20659Y0920

August 8, 2022

Re: Wilco CAC Changer order #2  
Georgetown, TX

Dear Joseph,

For the above-referenced project and per the plans provided by BLGY Architecture, we propose the following prices for the following items:

Material Cost Escalation: \$ 1,830  
OH&P (8.2%): \$ 150

**Toilet Partitions**

**\$1,980.00**

**Total \$1,980.00**

**Inclusions:**

- One Mobilization to field measure and one to install everything
- Southern Specialty & Accessory will not install grab bars, baby changing stations or shower seats without the necessary and proper wood blocking
- Manufacturer's Standard colors on all items
- **\*CHANGE IN PANEL SIZE & MANUFACTURER PRICE INCREASE**

**Exclusions:**

- Blocking of walls
- P & P Bonds
- Permits
- Tax

These prices are good for 30 days and are subject to review if there are any changes to the above referenced plans. Should you have any questions please do not hesitate to call.

Sincerely,

**Jose Mora**

972-821-8901



**Doyle Electric, LLC**  
917 Sixth St  
Marble Falls, Texas 78654  
Phone: 512-743-5534

## Request for Change Order

4/6/2023

**TO:**

Vaughn Construction  
Doug Boram  
Houston, Texas 77042

**JOB:**

Project: Wilco Children's Advocacy Center  
1811 SE Inner Loop  
Georgetown, TX 78626

Change Order Number: 593-18

**CHANGE ORDER INFORMATION: Power to Motorized Shades**

**WORK DESCRIPTION: Includes labor and material for additional power to motorized shades.**

The total amount of this Change Order is: **\$582.00**

Total Number of Working Days: 1

**Exclusions:**

- Tax
- Sheetrock Repair
- Paint
- Grid Repair
- Schedule Delays
- Additional Caulking
- Plugs/Sealing of sleeves
- Access Panels

Sincerely,

*Dustin Doyle*

Dustin Doyle  
Doyle Electric, LLC  
512-743-5534



Item#	Description	Qty	Price	Price Unit	Ext Price	Labor	Labor Unit	Ext Labor
9856	Cut-in Box with F Clips	1.00	5.70	E	5.70	1.00	E	0.00
9857	Electrician	3.00	0.00	C	0.00	1.00	E	3.00
						<b>5.70</b>		<b>3.00</b>

<b>Change Order Summary</b>	
Material Total	\$5.70
<b>Material Subtotal</b>	<b>\$5.70</b>
Electrician Hours	3.00
Electrician per Hour with Burden	\$38.77
Overtime Electrician Hours	0.00
OT Electrician per Hour with Burden	\$57.38
Superintendent Hours	1.00
Superintendent per Hour with Burden	\$63.88
OT Superintendent Hours	0.00
OT Superintendent per Hour with Burden	\$94.54
<b>Labor Subtotal</b>	<b>\$180.19</b>
Consumables (6% of material)	\$0.34
Project Management (5% of labor)	\$9.01
Safety (\$0.50 per labor hour)	\$1.50
Equipment	\$332.00
Subcontractors	\$0.00
<b>Direct Costs Subtotals</b>	<b>\$342.85</b>
Total Costs Subtotal	\$528.74
Overhead/Profit (10%)	\$52.87
<b>CHANGE ORDER TOTAL</b>	<b>\$582</b>



**Doyle Electric, LLC**  
917 Sixth St  
Marble Falls, Texas 78654  
Phone: 512-743-5534

## Request for Change Order

4/6/2023

**TO:**

Vaughn Construction  
Doug Boram  
Houston, Texas 77042

**JOB:**

Project: Wilco Children's Advocacy Center  
1811 SE Inner Loop  
Georgetown, TX 78626

Change Order Number: 593-19

**CHANGE ORDER INFORMATION: Relocate Receptacles per RFI 90**

**WORK DESCRIPTION: Includes labor and material for relocation of receptacles per RFI 90.**

The total amount of this Change Order is: **\$780.00**

Total Number of Working Days: 1

**Exclusions:**

- Tax
- Sheetrock Repair
- Paint
- Grid Repair
- Schedule Delays
- Additional Caulking
- Plugs/Sealing of sleeves
- Access Panels

Sincerely,

*Dustin Doyle*

Dustin Doyle  
Doyle Electric, LLC  
512-743-5534

Item#	Description	Qty	Price	Price Unit	Ext Price	Labor	Labor Unit	Ext Labor
9856	Electrician	7.50	0.00	C	0.00	1.00	E	7.50
					<b>0.00</b>			<b>7.50</b>

<b>Change Order Summary</b>	
Material Total	\$0.00
<b>Material Subtotal</b>	<b>\$0.00</b>
Electrician Hours	7.50
Electrician per Hour with Burden	\$38.77
Overtime Electrician Hours	0.00
OT Electrician per Hour with Burden	\$57.38
Superintendent Hours	1.00
Superintendent per Hour with Burden	\$63.88
OT Superintendent Hours	0.00
OT Superintendent per Hour with Burden	\$94.54
<b>Labor Subtotal</b>	<b>\$354.66</b>
Consumables (6% of material)	\$0.00
Project Management (5% of labor)	\$17.73
Safety (\$0.50 per labor hour)	\$4.25
Equipment	\$332.00
Subcontractors	\$0.00
<b>Direct Costs Subtotals</b>	<b>\$353.98</b>
Total Costs Subtotal	\$708.64
Overhead/Profit (10%)	\$70.86
<b>CHANGE ORDER TOTAL</b>	<b>\$780</b>



**Doyle Electric, LLC**  
917 Sixth St  
Marble Falls, Texas 78654  
Phone: 512-743-5534

## Request for Change Order

4/6/2023

**TO:**

Vaughn Construction  
Doug Boram  
Houston, Texas 77042

**JOB:**

Project: Wilco Children's Advocacy Center  
1811 SE Inner Loop  
Georgetown, TX 78626

Change Order Number: 593-20

**CHANGE ORDER INFORMATION: Additional AV Conduit in Conference Rm 160**

**WORK DESCRIPTION: Includes material and labor for additional AV conduit required in Conference Rm 160**

The total amount of this Change Order is: **\$1,129.00**

Total Number of Working Days: 1

**Exclusions:**

- Tax
- Sheetrock Repair
- Paint
- Grid Repair
- Schedule Delays
- Additional Caulking
- Plugs/Sealing of sleeves
- Access Panels

Sincerely,

*Dustin Doyle*

Dustin Doyle  
Doyle Electric, LLC  
512-743-5534

Item#	Description	Qty	Price	Price Unit	Ext Price	Labor	Labor Unit	Ext Labor
1003	1-1/4" EMT	30.00	330.08	C	99.02	6.20	C	0.00
1005	2" EMT	30.00	472.78	C	141.83	8.00	C	0.00
1567	1-1/4" Compression Steel Coupling	3.00	322.10	C	9.66	0.50	E	0.00
1569	2" Compression Steel Coupling	3.00	637.92	C	19.14	0.70	E	0.00
1609	1-1/4" Plastic Bushing	2.00	69.23	C	1.38	0.17	E	0.00
1611	2" Plastic Bushing	2.00	162.53	C	3.25	0.27	E	0.00
2373	1-1/4" Unistrut Strap	4.00	279.02	C	11.16	14.00	C	0.00
2375	2" Unistrut Strap	4.00	339.31	C	13.57	20.00	C	0.00
3078	1/8" Poly Pull Line	80.00	33.44	M	2.68	3.50	M	0.00
5932	Unistrut (Deep)	10.00	1150.04	C	115.04	20.00	C	0.00
5935	Cut 12 Gauge 1-5/8x1-5/8 Channel (labor)	5.00	0.00	E	0.00	0.26	E	0.00
						<b>416.74</b>		<b>4.50</b>

<b>Change Order Summary</b>	
Material Total	\$416.74
<b>Material Subtotal</b>	<b>\$416.74</b>
Electrician Hours	4.50
Electrician per Hour with Burden	\$38.77
Overtime Electrician Hours	0.00
OT Electrician per Hour with Burden	\$57.38
Superintendent Hours	1.00
Superintendent per Hour with Burden	\$63.88
OT Superintendent Hours	0.00
OT Superintendent per Hour with Burden	\$94.54
<b>Labor Subtotal</b>	<b>\$238.35</b>
Consumables (6% of material)	\$25.00
Project Management (5% of labor)	\$11.92
Safety (\$0.50 per labor hour)	\$2.75
Equipment	\$332.00
Subcontractors	\$0.00
<b>Direct Costs Subtotals</b>	<b>\$371.67</b>
Total Costs Subtotal	\$1,026.75
Overhead/Profit (10%)	\$102.68
<b>CHANGE ORDER TOTAL</b>	<b>\$1,129</b>



**Doyle Electric, LLC**  
917 Sixth St  
Marble Falls, Texas 78654  
Phone: 512-743-5534

## Request for Change Order

4/7/2023

**TO:**

Vaughn Construction  
Doug Boram  
Houston, Texas 77042

**JOB:**

Project: Wilco Children's Advocacy Center  
1811 SE Inner Loop  
Georgetown, TX 78626

Change Order Number: 593-21

**CHANGE ORDER INFORMATION: Upgrade Water Heater Circuit**

**WORK DESCRIPTION: Includes material and labor for upgrading water heater circuit due to higher amperage needed.**

The total amount of this Change Order is: **\$1,580.00**

Total Number of Working Days: 1

**Exclusions:**

- Tax
- Sheetrock Repair
- Paint
- Grid Repair
- Schedule Delays
- Additional Caulking
- Plugs/Sealing of sleeves
- Access Panels

Sincerely,

*Dustin Doyle*

Dustin Doyle  
Doyle Electric, LLC  
512-743-5534

Item#	Description	Qty	Price	Price Unit	Ext Price	Labor	Labor Unit	Ext Labor	
2662	#8 THHN CU Stranded Wire	160.00	573.78	M	91.80	0.00	M	0.00	
3238	60A/3P 600V HD Fus Safety Sw-Nema 1	1.00	465.81	E	465.81	0.00	E	0.00	
3339	40A 600V RK5 Time Delay Fuse	3.00	34.42	E	103.26	0.00	E	0.00	
3959	40A 3P 120/240V Bolt-On Circuit Breaker	1.00	67.40	E	67.40	0.00	E	0.00	
9857	Electrician	3.00	0.00	C	0.00	0.00	E	6.50	
								<b>728.27</b>	<b>6.50</b>

<b>Change Order Summary</b>	
Material Total	\$728.27
<b>Material Subtotal</b>	<b>\$728.27</b>
Electrician Hours	4.00
Electrician per Hour with Burden	\$38.77
Overtime Electrician Hours	0.00
OT Electrician per Hour with Burden	\$57.38
Superintendent Hours	2.50
Superintendent per Hour with Burden	\$63.88
OT Superintendent Hours	0.00
OT Superintendent per Hour with Burden	\$94.54
<b>Labor Subtotal</b>	<b>\$314.78</b>
Consumables (6% of material)	\$43.70
Project Management (5% of labor)	\$15.74
Safety (\$0.50 per labor hour)	\$1.50
Equipment	\$332.00
Subcontractors	\$0.00
<b>Direct Costs Subtotals</b>	<b>\$392.94</b>
Total Costs Subtotal	\$1,435.99
Overhead/Profit (10%)	\$143.60
<b>CHANGE ORDER TOTAL</b>	<b>\$1,580</b>



**Doyle Electric, LLC**  
917 Sixth St  
Marble Falls, Texas 78654  
Phone: 512-743-5534

## Request for Change Order

4/7/2023

**TO:**

Vaughn Construction  
Doug Boram  
Houston, Texas 77042

**JOB:**

Project: Wilco Children's Advocacy Center  
1811 SE Inner Loop  
Georgetown, TX 78626

Change Order Number: 593-22

**CHANGE ORDER INFORMATION: Refeed CU at North Mechanical Yard**

**WORK DESCRIPTION: Includes material and labor for refeeding condenser at North Mechanical Yard.**

The total amount of this Change Order is: **\$261.00**

Total Number of Working Days: 1

**Exclusions:**

- Tax
- Sheetrock Repair
- Paint
- Grid Repair
- Schedule Delays
- Additional Caulking
- Plugs/Sealing of sleeves
- Access Panels

Sincerely,

*Dustin Doyle*

Dustin Doyle  
Doyle Electric, LLC  
512-743-5534



Item#	Description	Qty	Price	Price Unit	Ext Price	Labor	Labor Unit	Ext Labor
2662	#10 THHN CU Stranded Wire	40.00	307.67	M	12.31	0.00	M	0.00
1269	3/4" Liquidtite Conduit	6.00	521.81	C	31.31	0.00	E	0.00
9857	Electrician	3.00	0.00	C	0.00	0.00	E	3.00
					<b>43.62</b>			<b>3.00</b>

<b>Change Order Summary</b>	
Material Total	\$43.62
<b>Material Subtotal</b>	<b>\$43.62</b>
Electrician Hours	3.00
Electrician per Hour with Burden	\$38.77
Overtime Electrician Hours	0.00
OT Electrician per Hour with Burden	\$57.38
Superintendent Hours	1.00
Superintendent per Hour with Burden	\$63.88
OT Superintendent Hours	0.00
OT Superintendent per Hour with Burden	\$94.54
<b>Labor Subtotal</b>	<b>\$180.19</b>
Consumables (6% of material)	\$2.62
Project Management (5% of labor)	\$9.01
Safety (\$0.50 per labor hour)	\$2.00
Equipment	\$0.00
Subcontractors	\$0.00
<b>Direct Costs Subtotals</b>	<b>\$13.63</b>
Total Costs Subtotal	\$237.43
Overhead/Profit (10%)	\$23.74
<b>CHANGE ORDER TOTAL</b>	<b>\$261</b>



**Doyle Electric, LLC**  
917 Sixth St  
Marble Falls, Texas 78654  
Phone: 512-743-5534

## Request for Change Order

4/7/2023

**TO:**

Vaughn Construction  
Doug Boram  
Houston, Texas 77042

**JOB:**

Project: Wilco Children's Advocacy Center  
1811 SE Inner Loop  
Georgetown, TX 78626

Change Order Number: 593-24

**CHANGE ORDER INFORMATION: Additional FA Conduit between New and Existing Building**

**WORK DESCRIPTION: Includes material and labor for additional conduit between new and existing building.**

The total amount of this Change Order is: **\$340.00**

Total Number of Working Days: 1

**Exclusions:**

- Tax
- Sheetrock Repair
- Paint
- Grid Repair
- Schedule Delays
- Additional Caulking
- Plugs/Sealing of sleeves
- Access Panels

Sincerely,

*Dustin Doyle*

Dustin Doyle  
Doyle Electric, LLC  
512-743-5534

Item#	Description	Qty	Price	Price Unit	Ext Price	Labor	Labor Unit	Ext Labor
1001	3/4" EMT	20.00	106.04	C	21.21	0.00	C	0.00
1545	3/4" Set Screw Steel Conn	7.00	346.50	C	24.26	0.00	E	0.00
2339	3/4" 1-Hole Strap	2.00	55.24	C	1.10	0.00	C	0.00
2477	4-11/16" Square Box Comb KO's	3.00	6945.20	M	20.84	0.00	E	0.00
6163	Anchors	7.00	30.00	C	2.10	0.00	E	0.00
6197	3\4" Bushing	3.00	0.93	E	2.79	0.00	E	0.00
9857	Electrician	4.00	0.00	C	0.00	0.00	E	4.00
<b>72.29</b>								<b>4.00</b>

<b>Change Order Summary</b>	
Material Total	\$72.29
<b>Material Subtotal</b>	<b>\$72.29</b>
Electrician Hours	4.00
Electrician per Hour with Burden	\$38.77
Overtime Electrician Hours	0.00
OT Electrician per Hour with Burden	\$57.38
Superintendent Hours	1.00
Superintendent per Hour with Burden	\$63.88
OT Superintendent Hours	0.00
OT Superintendent per Hour with Burden	\$94.54
<b>Labor Subtotal</b>	<b>\$218.96</b>
Consumables (6% of material)	\$4.34
Project Management (5% of labor)	\$10.95
Safety (\$0.50 per labor hour)	\$2.50
Equipment	\$0.00
Subcontractors	\$0.00
<b>Direct Costs Subtotals</b>	<b>\$17.79</b>
Total Costs Subtotal	\$309.03
Overhead/Profit (10%)	\$30.90
<b>CHANGE ORDER TOTAL</b>	<b>\$340</b>



4603 COMMERCIAL PARK DRIVE ■ AUSTIN, TEXAS 78724

April 17, 2023

## PROPOSAL

**Submitted to: Vaughn Construction**

**Project Name: Wilco Advocacy Center-Sound Masking**

**Location: Georgetown, Texas**

## SCOPE OF WORK

This proposal covers custom sound masking systems. Carroll Systems is a MPS Certified Installer and can offer a manufacture warranty.

### **Custom sound masking system to include:**

- 1.) Install 1, networkable, 4x M24 4 channel MPS control module in the server room or other discreet location. Master control module and power supply requires a standard 115v outlet plug. Install **14**, full-spectrum voice arrest speakers per included design drawing. Speaker placement design focuses on coverage of the primary open corridor area. The conference room, and private offices break room are excluded and the open corridor area are indicated by (Red, Blue & Purple dots). The grid pattern allows consistent and pleasant sound masking sound throughout the treated space.
- 2.) “Adaptive Technology” allows the system to automatically make volume adjustments according to the current sound/voice/noise level. Quite simply – it ramps up the sound masking volume when it’s noisy, and scales it back when it’s not. This feature also provides additional energy savings. This optional feature would include **0** sensors to be installed centrally in exposed ceiling in the open office area.

- 3.) All work will be performed during normal working hours.
  - 4.) A 1–2-hour onsite training will be scheduled before “go-live”.
- ✓ State-of-the art, software-driven sound masking system utilizing full-range, plenum installed speakers installed in a grid pattern to provide focused and comfortable sound masking throughout the designated treated areas.
  - ✓ Available Adaptive Technology control. Ceiling-installed sensors automatically adjust the volume level of the sound masking depending on the current voice/noise level of the treated space. Patented technology – available in no other sound masking system currently in production
  - ✓ 5-year warranty on all system components
  - ✓ I.P. addressable – System can be controlled from any wireless notebook computer (or desktop) that logs onto the sound masking wireless network – or via optional touchpad.
  - ✓ Fully expandable and re-configurable. Additional controllers/speakers/zones can be added in the future at a reduced cost.
  - ✓ No tuning, maintenance, or updating required - truly “set and forget.”
  - ✓ Fully detailed wiring diagram highlighting zone, speaker, controller, and sensor placement
  - ✓ We provide a Project Manager to oversee the project.

### Pricing

Description	Price
Materials	\$5,137.00
Labor	\$2,722.00
<b>Total</b>	<b>\$7,859.00</b>

## Material

QTY	UM	MANF.	PART #	DESCRIPTION
1000	ea	ReelSimple	112000-09	18/2 AWG Wire CMP
4	ea	MPS	VA-SURF4	VoiceArrest Surface Mount Speaker-4"
10	ea	MPS	VA-DIRB	VoiceArrest Plenum Speaker Black
1	ea	MPS	VA-24PKG	VA-24 Controller Package
1	ea	0	0	Velcro
1	ea	Spec Seal	SSP100	Fire Putty
20	ea	Panduit	JP75W-L20	J Hooks
1	lot	0	0	10-9900 MISC

## PROVISIONS

Any additional work not specified in this scope of work or any additional work request from customer may result in a change order.

**This proposal does not include bond costs.** Carroll Systems is bondable and can obtain a bond upon contact award if desired by customer.

**Lift Rental is included in the cost will be needed to route cable and mount speakers in heigh ceiling areas. Floor coverings to be provided by Vaughn and laid out by Carroll Systems as needed to shuffle lift.**

This quotation is based on asbestos-free environment.

Project delays outside of Carroll System's control, including but not limited to delay by other trades or customer, could result in additional cost to customer.

This proposal pricing is good for a period of 30 days.

This quotation assumes that detailed "As-Built" drawings (floor plans), key sheets, cable/jack configuration including all existing inside and outside cable plant will be provided by customer and will be ready prior to cable installations.

This quotation assumes that all existing and new conduits are properly sized and that any new conduits, power poles, core holes, floor or wall penetrations, and floor boxes will be provided by other vendors and will be ready prior to cable installation.

**ACCEPTANCE**

We hereby propose to furnish material and labor - complete in accordance with the enclosed scope of work for the sum of:

**Seven Thousand Eight Hundred Fifty-Nine Dollars and 00/100**

**\$7,859.00**

Payment to be made as follows: Net 30 days

Sales tax: Exempt:   X      Resale         Taxable:     

All material is guaranteed to be as specified. All work to be completed in a workmanlike manner according to standard practices. Any alteration or deviation from enclosed specifications involving extra costs will be executed only upon written orders, and will become an extra charge over and above the estimate. All agreements contingent upon strikes, accidents or delays beyond our control. Owner to carry fire, tornado and other necessary insurance. Our employees are fully covered by Workmen’s Compensation Insurance.

Authorized Signature: \_\_\_\_\_

Note: This proposal may be withdrawn by us if not accepted within Thirty (30) days.

Acceptance of Proposal: The above prices, specifications and conditions are satisfactory and are hereby accepted. You are authorized to do the work as specified. Payment will be made as outlined above.

\_\_\_\_\_  
Date of Acceptance

\_\_\_\_\_  
Signature

\_\_\_\_\_  
Signature

Respectfully,

Richard Wehr  
Project Manager  
Carroll Systems

O 512-927-1200  
F 512-927-1355  
C 512-844-2197

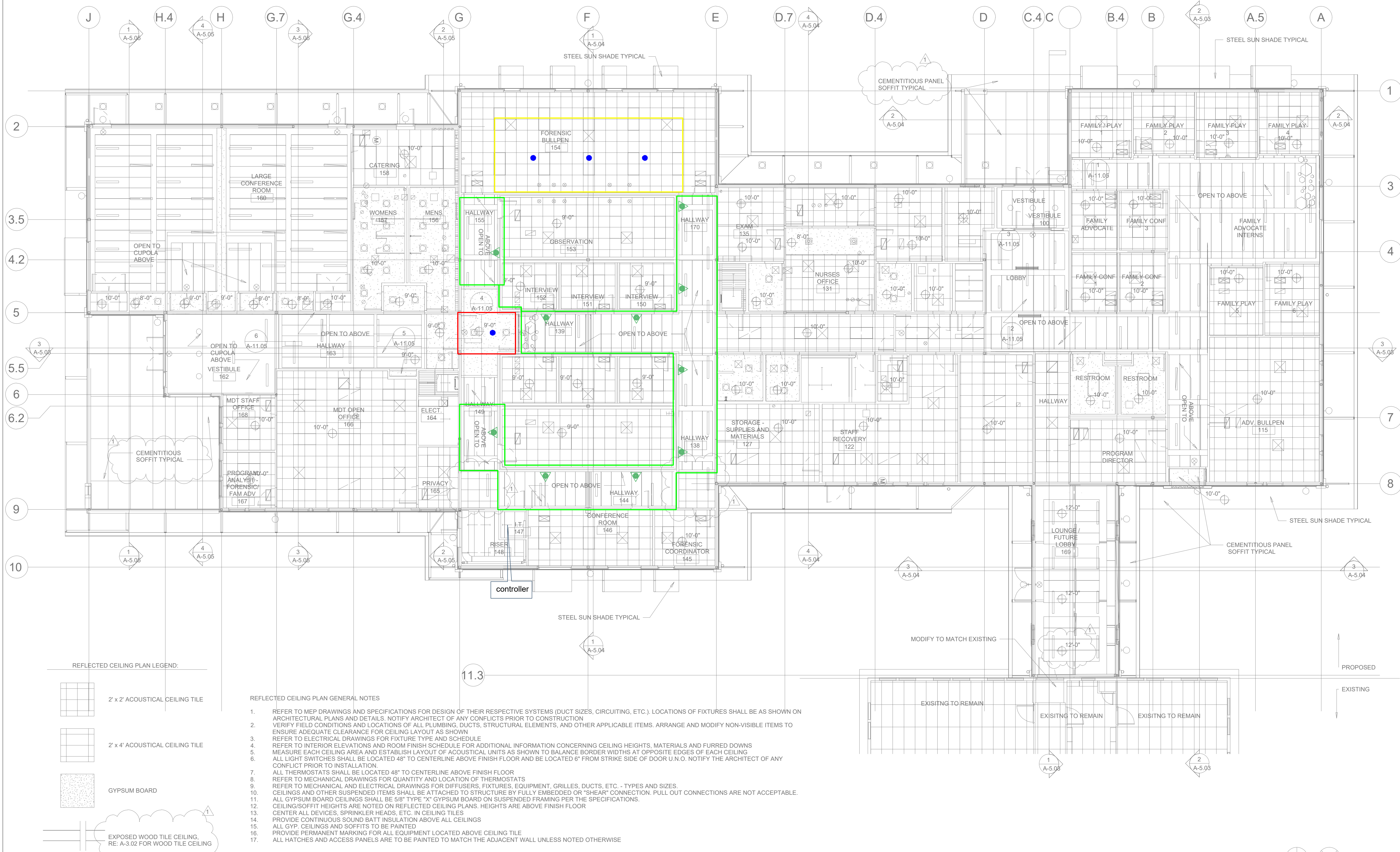

Equipment	Qty
VA-SPK plenum	0
VA-DIR-B exposed	10
VA-FLAT	0
VA-HDN	0
VA-SURF4W	4
VA-SEN	0
VA-VibX	0
VA-CTRL	0

Rev.	Date	By
A	3/29/2023	GW
B	4/5/2023	GW
C	4/12/2023	GW
D	4/14/2023	GW

Carroll Systems LP - Austin  
 Childrens Advocacy Center



MPS Acoustics  
 McKinney, TX  
 Trenton, TX  
 866-557-8438

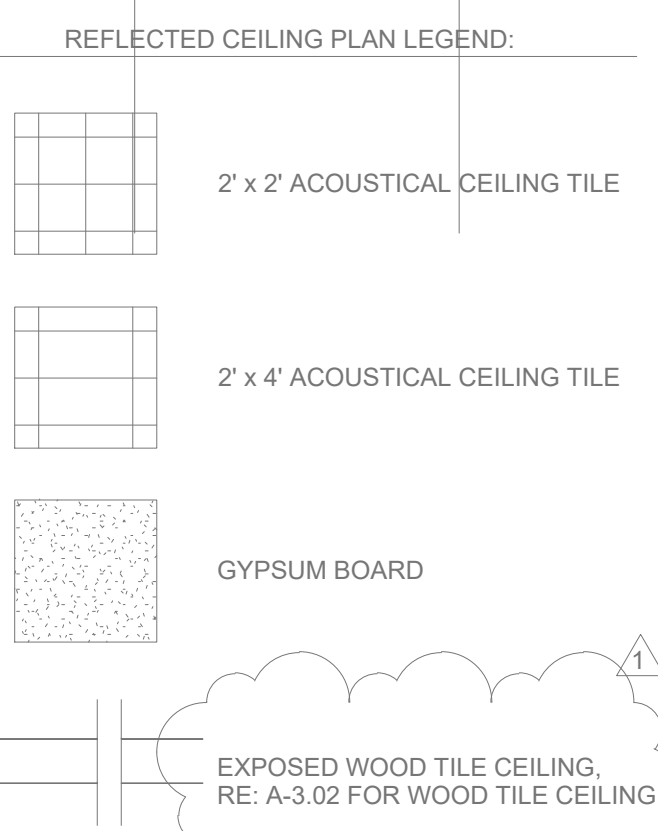

- REFLECTED CEILING PLAN GENERAL NOTES
- REFER TO MEP DRAWINGS AND SPECIFICATIONS FOR DESIGN OF THEIR RESPECTIVE SYSTEMS (DUCT SIZES, CIRCUITING, ETC.). LOCATIONS OF FIXTURES SHALL BE AS SHOWN ON ARCHITECTURAL PLANS AND DETAILS. NOTIFY ARCHITECT OF ANY CONFLICTS PRIOR TO CONSTRUCTION
  - VERIFY FIELD CONDITIONS AND LOCATIONS OF ALL PLUMBING, DUCTS, STRUCTURAL ELEMENTS, AND OTHER APPLICABLE ITEMS. ARRANGE AND MODIFY NON-VISIBLE ITEMS TO ENSURE ADEQUATE CLEARANCE FOR CEILING LAYOUT AS SHOWN
  - REFER TO ELECTRICAL DRAWINGS FOR FIXTURE TYPE AND SCHEDULE
  - REFER TO INTERIOR ELEVATIONS AND ROOM FINISH SCHEDULE FOR ADDITIONAL INFORMATION CONCERNING CEILING HEIGHTS, MATERIALS AND FURRED DOWNS
  - MEASURE EACH CEILING AREA AND ESTABLISH LAYOUT OF ACOUSTICAL UNITS AS SHOWN TO BALANCE BORDER WIDTHS AT OPPOSITE EDGES OF EACH CEILING
  - ALL LIGHT SWITCHES SHALL BE LOCATED 48" TO CENTERLINE ABOVE FINISH FLOOR AND BE LOCATED 6" FROM STRIKE SIDE OF DOOR U.N.O. NOTIFY THE ARCHITECT OF ANY CONFLICT PRIOR TO INSTALLATION.
  - ALL THERMOSTATS SHALL BE LOCATED 48" TO CENTERLINE ABOVE FINISH FLOOR
  - REFER TO MECHANICAL DRAWINGS FOR QUANTITY AND LOCATION OF THERMOSTATS
  - REFER TO MECHANICAL AND ELECTRICAL DRAWINGS FOR DIFFUSERS, FIXTURES, EQUIPMENT, GRILLES, DUCTS, ETC. - TYPES AND SIZES.
  - CEILINGS AND OTHER SUSPENDED ITEMS SHALL BE ATTACHED TO STRUCTURE BY FULLY EMBEDDED OR "SHEAR" CONNECTION. PULL OUT CONNECTIONS ARE NOT ACCEPTABLE.
  - ALL GYPSUM BOARD CEILINGS SHALL BE 5/8" TYPE "X" GYPSUM BOARD ON SUSPENDED FRAMING PER THE SPECIFICATIONS.
  - CEILING/SOFFIT HEIGHTS ARE NOTED ON REFLECTED CEILING PLANS. HEIGHTS ARE ABOVE FINISH FLOOR
  - CENTER ALL DEVICES, SPRINKLER HEADS, ETC. IN CEILING TILES
  - PROVIDE CONTINUOUS SOUND BATT INSULATION ABOVE ALL CEILINGS
  - ALL GYP. CEILINGS AND SOFFITS TO BE PAINTED
  - PROVIDE PERMANENT MARKING FOR ALL EQUIPMENT LOCATED ABOVE CEILING TILE
  - ALL HATCHES AND ACCESS PANELS ARE TO BE PAINTED TO MATCH THE ADJACENT WALL UNLESS NOTED OTHERWISE

**1 REFLECTED CEILING PLAN**  
 1/8" = 1'-0"

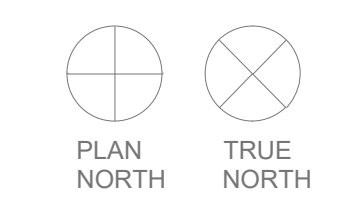



# A K FUQUAY CONSTRUCTION

CERTIFIED WBE/DBE

Main office: P.O. Box 310335 New Braunfels, TX 78131 Phone (512) 260-9899 Fax (512) 260-9009  
www.fuquay.com

## CHANGE ORDER

DATE March 31, 2023

PROJECT WILCO CHILDREN'S ADVOCACY CENTER ADDITION

WE PROPOSE TO PROVIDE ALL THE MATERIALS, LABOR, EQUIPMENT AND SUPERVISION NECESSARY TO COMPLETE THE FOLLOWING ITEMS FOR THE PROJECT REFERENCED ABOVE.

ITEM NUMBER/ DESCRIPTION	ESTIMATED QUANTITY	UNIT PRICE	ESTIMATED COST
-----------------------------	-----------------------	---------------	-------------------

Please send over a deductive change order for the construction entrance that will not be done. Thanks,  
Jason

*CONSTRUCTION ENTRANCE <i>12X50, Underlined with fabric</i>	1 EA	\$ 1,350.00 EA	\$ 1,350.00
--	------	----------------	-------------

RED & WHITE GREENERY, INC.

P. O. BOX 126  
 GEORGETOWN, TX 78627

# Estimate

Date	Estimate #
3/24/2023	033426BS
Project	
T&M Excavation	
P.O. No.	

Name / Address
WILCO Children's Advocacy Center 1811 SE Inner Loop Georgetown, TX. 78626

Description	Qty	Unit of Measure...	Rate	Total
Field Request for T&M Bed Excavation 3.16.23				
Labor for Excavation of Beds	40	mh	43.50	1,740.00
Skid Loader (2 for 1 day)	1	days	819.00	819.00
Mini Excavator	1	days	441.00	441.00
**spoils spread onsite**				

			<b>Subtotal</b>	\$3,000.00
Phone #	Fax #	Web Site	<b>Sales Tax (8.25%)</b>	\$0.00
512-930-4707	512-869-2521	www.rwgreenery.com	<b>Total</b>	\$3,000.00

RED & WHITE GREENERY, INC.

P. O. BOX 126  
 GEORGETOWN, TX 78627

# Estimate

Date	Estimate #
3/27/2023	033427BS
Project	
ASI 30 Addition- Fencing Changes	
P.O. No.	

Name / Address
WILCO Children's Advocacy Center 1811 SE Inner Loop Georgetown, TX. 78626

Description	Qty	Unit of Measure...	Rate	Total
ASI 30 dated 12.21.22- Fencing Change/Addition of Gates				
Addition of (2) 4' Standard Walk Gates, (1) Double 8' Standard Maintenance Gates, (2) Egress Standard Walk Gates prepped for ADA compliant hardware supplied by others.	1	ls	7,266.14	7,266.14
Alternate #1- Provide Self closing Hinges for ADA Gates if hardware installer does not provide self closing hinges with package. ADD- \$2,030.00				

			<b>Subtotal</b>	\$7,266.14
Phone #	Fax #	Web Site	<b>Sales Tax (8.25%)</b>	\$0.00
512-930-4707	512-869-2521	www.rwgreenery.com	<b>Total</b>	\$7,266.14



Texas Traditions Roofing, LLC  
508 Cedar Drive  
Georgetown, TX 78628



**Recommendation Provided To:**

Vaughn Construction  
6604 N Lamar Blvd.  
Austin, TX 78752  
512-663-7461  
[dougboram@vaughnconstruction.com](mailto:dougboram@vaughnconstruction.com)

**Date Provided:**

April 17, 2023

**License #: 03-0321**

**Recommendation Provided by:**

Jameson Riser  
559-779-1207

**Scope:**

Custom Metal Column Wraps at two (2) locations.

**Base Price:** **\$ 11,883**

*Price Valid for 60 days.*

**Inclusions:**

Wrap column with insulation.  
Install custom metal column wraps in Berridge 22-gauge Cityscape finish.

**Exclusions:**

Fire proofing.  
Framing of the columns.  
Round perforated metal mesh panels.  
16-gauge metal.  
Any other work not mentioned above.





**CONTRACT CHANGE ORDER**

Project Name: Williamson County CAC

Project Number: \_\_\_\_\_

Date: 3/10/2023

To: Vaughn

Attn: Clayton

CCO No. \_\_\_\_\_

Description: Re-Flashing Sun Clips

Line items:	Amount:
Labor	\$ 987.00
Material (+lift time)	\$ 1,400.00
<b>Subtotal:</b>	<b>\$ 2,387.00</b>
This CCO:	\$ 2,387.00

Aquatech Waterproofing

Vaughn

Brian C. King 3-10-23  
Name Date

\_\_\_\_\_  
Name Date



**CONTRACT CHANGE ORDER**

Project Name: Wilco CAC

Project Number:

Date: 4/5/2023

To: Vaughn

Attn: Clayton Coleman

CCO No.

**Description:** *Hollow Door Frames and wide expansion joint*

Line items:	Amount:
Labor	\$ 732.00
Material	\$ 350.00
OH and Profit	\$ 108.20

---

**Subtotal:** \$ 1,190.20

---

Original Contract:	
Previous CCO's:	
This CCO:	\$ 1,190.20
<b>Total Contract:</b>	<b>\$ 1,190.20</b>

Signature Block:  
Aquatech Waterproofing

Vaughn

  
Name \_\_\_\_\_ Date 4/5/23

\_\_\_\_\_  
Name \_\_\_\_\_ Date \_\_\_\_\_



**CONTRACT CHANGE ORDER**

Project Name: Wilco CAC

Project Number: \_\_\_\_\_

Date: 4/18/2023

To: Vaughn

Attn: Clayton

CCO No. \_\_\_\_\_

Description: Caulk trim to masonry

Line items:	Amount:
Labor	\$ 1,175.00
Material	\$ 1,100.00
OH and Profit	\$ 227.50
<b>Subtotal:</b>	<b>\$ 2,502.50</b>
<b>This CCO:</b>	<b>\$ 2,502.50</b>

Aquatech Waterproofing

Vaughn

Brent C. Hays 4/18/23  
 Name Date

\_\_\_\_\_  
 Name Date





**Fabricators of Commercial and Industrial Steel**

City of Houston Certified #367  
 1912 Buschong St. Houston, TX 77039  
 (713) 691-5200 Main Fax (713) 691-3355 Sales Fax (713) 691-4646

**\*\*\* CHANGE ORDER REQUEST \*\*\***

DATE OF CHANGE ORDER March 16, 2023  
 DATE OF LAST REVISION  
 MYREX JOB NO. 11804  
 MYREX CHANGE NO. -012  
 CUSTOMER CHANGE ORDER OR RFI NO. Email Request  
 PROJECT Wilco Children's Advocacy Center  
 CONTRACTOR NAME Vaughn Construction (ATX)  
 PROJECT MANAGER Doug Boram  
 JOB SITE PHONE  
 JOB SITE FAX

**PLEASE PROCESS A CHANGE ORDER TO OUR PURCHASE ORDER FOR THE EXTRA WORK DESCRIBED BELOW:**

Added 2 line rail at concrete steps

*All material will be painted with one coat of Myrex standard shop primer with SSPC-SP2 cleaning u.n.o.*

Materials

				Material Amount	250.00	
Fabrication	Manhours	10.00	Hourly Rate	55.00	Fabrication Labor	550.00
	Detailing	5.00	Hourly Rate	60.00	Detailing Time	300.00
	Project Mgr		Hourly Rate		Project Mgr Time	0.00
				Freight	350.00	

**ITEM DESCRIPTIONS AND AMOUNTS: Galvanizing, Miscellaneous, Buyouts, etc.**

	Galvanizing	150.00

See Page 2 for Grand Total

Subtotal from Page 1 | 1,600.00

5.00% Overhead | 80.00

5.00% Profit | 80.00

Erection |

Erection Overhead/Profit | 0.00

NOTES

Empty rectangular box for notes.

CHANGE TOTALS

Change Amount | 1,760.00

Tax Amount | 0.00

GRAND TOTAL | 1,760.00

The status of this Change Order is **Unapproved**

Approved = Myrex has received formal Change Order.

Unapproved = Myrex has been authorized to proceed, with formal Change Order to follow.

Quoted only = Myrex has not been authorized to proceed.

PIP = Pricing In Progress.

Please initial here \_\_\_\_\_ to verify Change Order status.

MYREX INDUSTRIES

Vaughn Construction (ATX)

Ryan Sevcik

Authorized Signature

**DUE TO VOLATILITY IN THE CURRENT STEEL MARKET THE PRICE QUOTED ON THIS CHANGE ORDER WILL BE SUBJECT TO POSSIBLE ESCALATION IF THE ORDER IS NOT RECEIVED IN 24 HOURS.**

**EXTRA WORK WILL NOT BE PERFORMED UNTIL A SIGNED COPY OF THIS REQUEST IS RETURNED TO MYREX INDUSTRIES.**

**THE CHANGES QUOTED HEREIN WILL IMPACT THE MYREX PRODUCTION SCHEDULE BY A MINIMUM OF 2.00 WORKING DAYS.**

FINISH:  
SURFACE PREP:

SCALE:  
DATE:

MYREX INDUSTRIES  
CITY OF HOUSTON CERTIFIED # 382, 383 & 389  
WELDER

DATE: 03-22  
DATE: 03-22  
DATE: 03-22  
DATE: 03-22

VAUGHN CONSTRUCTION (ATX)  
PROJECT: WILCO CHILDREN'S ADVOCACY CENTER  
LOCATION: GEORGETOWN, TX

11804  
ME-103

NOTE: UNLESS OTHERWISE SPECIFIED, ALL WELDING TO BE PERFORMED IN ACCORDANCE WITH AWS D11.1 WITH EXXXL FILLER METAL

NOTE \* IMPORTANT \* NOTE  
We will not accept charges for labor, materials, or corrective work unless duly authorized.

REV. NO.	DESCRIPTION	DATE	BY	DATE
1	FOR APPROVAL			
2				
3				
4				
5				
6				
7				
8				
9				
10				

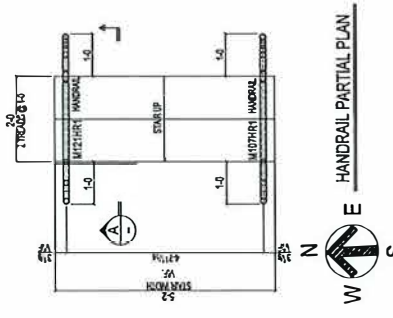
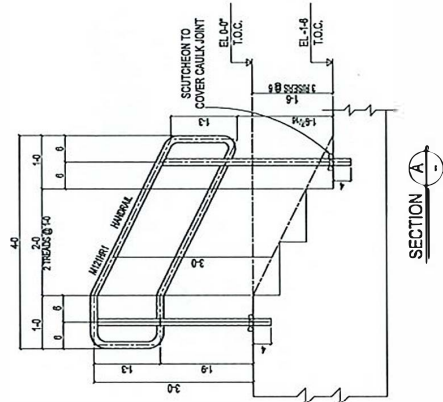



**Fabricators of Commercial and Industrial Steel**

City of Houston Certified #367  
 1912 Buschong St. Houston, TX 77039  
 (713) 691-5200 Main Fax (713) 691-3355 Sales Fax (713) 691-4646

**\*\*\* CHANGE ORDER REQUEST \*\*\***

DATE OF CHANGE ORDER April 6, 2023  
 DATE OF LAST REVISION  
 MYREX JOB NO. 11804  
 MYREX CHANGE NO. -013  
 CUSTOMER CHANGE ORDER OR RFI NO. Email Request  
 PROJECT Wilco Children's Advocacy Center  
 CONTRACTOR NAME Vaughn Construction (ATX)  
 PROJECT MANAGER Doug Boram  
 JOB SITE PHONE  
 JOB SITE FAX

**PLEASE PROCESS A CHANGE ORDER TO OUR PURCHASE ORDER FOR THE EXTRA WORK DESCRIBED BELOW:**

**Additional diamond plate for mechanical trough covers**

*All material will be painted with one coat of Myrex standard shop primer with SSPC-SP2 cleaning u.n.o.*

Materials

				Material Amount	350.00	
Fabrication	Manhours	6.00	Hourly Rate	55.00	Fabrication Labor	330.00
	Detailing	4.00	Hourly Rate	60.00	Detailing Time	240.00
	Project Mgr		Hourly Rate		Project Mgr Time	0.00
				Freight	650.00	

**ITEM DESCRIPTIONS AND AMOUNTS: Galvanizing, Miscellaneous, Buyouts, etc.**

	Galvanizing	250.00

**See Page 2 for Grand Total**

Subtotal from Page 1

Overhead

Profit

Erection

Erection Overhead/Profit

NOTES

CHANGE TOTALS

Change Amount

Tax Amount

GRAND TOTAL

The status of this Change Order is **Unapproved**

Approved = Myrex has received formal Change Order.

Unapproved = Myrex has been authorized to proceed, with formal Change Order to follow.

Quoted only = Myrex has not been authorized to proceed.

PIP = Pricing In Progress.

Please initial here \_\_\_\_\_ to verify Change Order status.

MYREX INDUSTRIES

Vaughn Construction (ATX)

Ryan Sevcik

Authorized Signature

**DUE TO VOLATILITY IN THE CURRENT STEEL MARKET THE PRICE QUOTED ON THIS CHANGE ORDER WILL BE SUBJECT TO POSSIBLE ESCALATION IF THE ORDER IS NOT RECEIVED IN 24 HOURS.**

**EXTRA WORK WILL NOT BE PERFORMED UNTIL A SIGNED COPY OF THIS REQUEST IS RETURNED TO MYREX INDUSTRIES.**

**THE CHANGES QUOTED HEREIN WILL IMPACT THE MYREX PRODUCTION SCHEDULE BY A MINIMUM OF 0.00 WORKING DAYS.**