

WILLIAMSON COUNTY
LICENSE AGREEMENT

WILLIAMSON COUNTY, TEXAS a political subdivision of the State of Texas (the “County”), and the Municipal Utility District named on the signature page hereinbelow, being a political subdivision of the State of Texas (the “Licensee”), enter into this License Agreement (the “Agreement”) upon the terms and conditions set forth below.

I. PURPOSE OF LICENSE AGREEMENT

Licensee has requested permission from County to install, operate, maintain and repair additions, including, but not limited to sidewalks, accessible ramps, trails, landscaping, lighting, fencing, signage and irrigation systems (collectively referred to herein as the “Licensee’s Improvements”) in portions of the County’s right-of-way. Subject to the terms and conditions of this Agreement, the County grants to Licensee permission to install, repair and maintain Licensee’s Improvements in the areas of County’s right-of-way shown and depicted in the attached **Exhibit “A”** (the “Licensed Property”). The parties acknowledge that this Agreement does not apply to, or affect any interests, rights and obligations regarding water, wastewater, drainage facilities or other utilities located or to be located within the Licensed Property pursuant to any validly issued permits or executed easements related thereto.

The County makes this grant solely to the extent of its right, title and interest in the Licensed Property, without any express or implied warranties.

Licensee agrees that all construction, repair, operation and maintenance permitted by this Agreement shall be done in compliance with the terms and conditions of this Agreement and all applicable County, State and/or Federal police, traffic, building, health and safety ordinances, laws and regulations existing at the time said construction, repair, operation and maintenance is performed.

II. ANNUAL FEE

The County, its governing body, and its respective successors and assigns agree that no annual fee shall be assessed for the license and permission herein granted to Licensee. Licensee agrees that the County’s permission and grant of a license hereunder and Licensee’s ability to construct Licensee’s Improvements on the Licensed Property serve as consideration to support this Agreement.

III. COUNTY’S RIGHTS TO LICENSED PROPERTY

This Agreement is expressly subject and subordinate to the present and future rights of the County, its successors, assigns, lessees, grantees and licensees, to construct, install, establish, maintain, use, operate and renew any public utilities facilities, franchised public utilities, roadways or streets on, beneath or above the surface of the Licensed Property described in Article I above.

Nothing in this Agreement shall be construed to limit, in any way, the power of the County to widen, alter or improve the Licensed Property subject to this Agreement pursuant to official action by the governing body of the County or its successors. The County does, however, agree to

give Licensee at least thirty (30) days written notice of such action and shall cooperate with Licensee to effect the relocation and/or removal of Licensee's Improvements, at Licensee's sole cost, in the event of such widening, altering or improvement of the Licensed Property, further, to cooperate with Licensee wherever possible, to effect such widening, altering or improving of the Licensed Property so that Licensee's Improvements and operations on the Licensed Property will not be materially affected thereby.

Licensee hereby agrees and acknowledges that Licensee, at its expense, shall be responsible for removal of Licensee's Improvements from the Licensed Property within forty-eight (48) hours of County's directive to remove specified Licensee's Improvements whenever such removal is deemed by County necessary for: (a) exercising the County's rights or duties with respect to the Licensed Property; (b) protecting persons or property; or (c) protecting the public health or safety with respect to the Licensed Property. In the event Licensee fails to remove the Licensee's Improvements to the County's satisfaction following County's directive to do so, then and in that event the County may cause the Improvements to be removed at the expense of Licensee.

Notwithstanding any provision in this Agreement to the contrary, the County retains the right to enter upon the Licensed Property, at any time without notice to Licensee, assuming no obligation to Licensee, and remove, repair or replace, without liability to County and at Licensee's expense, any of the Licensee's Improvements thereof whenever such removal is deemed by County necessary for: (a) exercising the County's rights or duties with respect to the Licensed Property; (b) protecting persons or property; or (c) protecting the public health or safety with respect to the Licensed Property.

IV. INSURANCE

Licensee shall, at its sole expense, provide a commercial general liability insurance policy, written by a company acceptable to the County and licensed to do business in Texas, with a combined single limit of not less than One Million and No/100 Dollars (\$1,000,000.00), which coverage may be provided in the form of a rider and/or endorsement to a previously existing insurance policy. Such insurance coverage shall specifically name the County as an additional insured. This insurance coverage shall cover all perils arising from the activities of Licensee, its officers, directors, employees, agents or contractors, relative to this Agreement. Licensee shall be responsible for any deductibles stated in the policy. A true copy of each instrument effecting such coverage shall be delivered to the County on or before the Effective Date.

So long as Licensee is using the Licensed Property, Licensee shall not cause such insurance to be canceled nor permit such insurance to lapse. All insurance certificates shall include a clause to the effect that the policy shall not be canceled, reduced, restricted or otherwise limited until thirty (30) days after the County has received written notice as evidenced by a return receipt of registered or certified mail.

V. INDEMNIFICATION

INDEMNIFICATION - EMPLOYEE PERSONAL INJURY CLAIMS. TO THE FULLEST EXTENT PERMITTED BY LAW, THE LICENSEE SHALL INDEMNIFY, DEFEND (WITH COUNSEL OF COUNTY'S CHOOSING), AND HOLD HARMLESS COUNTY, AND COUNTY'S EMPLOYEES, AGENTS, REPRESENTATIVES, PARTNERS,

OFFICERS, AND DIRECTORS (COLLECTIVELY, THE "INDEMNITEES") AND SHALL ASSUME ENTIRE RESPONSIBILITY AND LIABILITY (OTHER THAN AS A RESULT OF COUNTY'S GROSS NEGLIGENCE) FOR ANY CLAIM OR ACTION BASED ON OR ARISING OUT OF THE PERSONAL INJURY, OR DEATH, OF ANY EMPLOYEE OF THE LICENSEE, OR OF ANY SUBCONTRACTOR, OR OF ANY OTHER ENTITY FOR WHOSE ACTS THEY MAY BE LIABLE, WHICH OCCURRED OR WAS ALLEGED TO HAVE OCCURRED ON THE PROJECT SITE OR IN CONNECTION WITH THE PERFORMANCE OF THE WORK. LICENSEE HEREBY INDEMNIFIES THE INDEMNITEES EVEN TO THE EXTENT THAT SUCH PERSONAL INJURY WAS CAUSED OR ALLEGED TO HAVE BEEN CAUSED BY THE SOLE, COMPARATIVE OR CONCURRENT NEGLIGENCE OF THE STRICT LIABILITY OF ANY INDEMNIFIED PARTY. THIS INDEMNIFICATION SHALL NOT BE LIMITED TO DAMAGES, COMPENSATION, OR BENEFITS PAYABLE UNDER INSURANCE POLICIES, WORKERS COMPENSATION ACTS, DISABILITY BENEFITS ACTS, OR OTHER EMPLOYEES BENEFIT ACTS.

INDEMNIFICATION - OTHER THAN EMPLOYEE PERSONAL INJURY CLAIMS. TO THE FULLEST EXTENT PERMITTED BY LAW, LICENSEE SHALL INDEMNIFY, DEFEND (WITH COUNSEL OF COUNTY'S CHOOSING), AND HOLD HARMLESS INDEMNITEES FROM AND AGAINST CLAIMS, DAMAGES, LOSSES AND EXPENSES, INCLUDING BUT NOT LIMITED TO ATTORNEYS' FEES, ARISING OUT OF OR ALLEGED TO BE RESULTING FROM THE PERFORMANCE OF THIS AGREEMENT OR THE WORK DESCRIBED HEREIN, TO THE EXTENT CAUSED BY THE NEGLIGENCE, ACTS, ERRORS, OR OMISSIONS OF LICENSEE OR ITS SUBCONTRACTORS, ANYONE EMPLOYED BY THEM OR ANYONE FOR WHOSE ACTS THEY MAY BE LIABLE, REGARDLESS OF WHETHER OR NOT SUCH CLAIM, DAMAGE, LOSS OR EXPENSE IS CAUSED IN WHOLE OR IN PART BY A PARTY INDEMNIFIED HEREUNDER.

VI. CONDITIONS

A. Plan Review. Licensee's Improvements shall not be erected, placed, constructed or altered after being constructed on any of the Licensed Property until Licensee's plans and specifications for Licensee's Improvements have been approved, in writing, by County's Engineer or its authorized representatives. Licensee's required plans and specifications for all proposed improvements shall be submitted to County's Engineer and include necessary and applicable details such as site plan, landscape plans, irrigation plans, exterior elevations, drainage and grading plans and/or exterior materials. Approval of plans is at the sole discretion of the County's Engineer. The County Engineer will review all plans in the normal course of business and will make good faith efforts to issue remarks and approvals without unreasonable delay. Once the required plans and specifications are approved by the County Engineer, Licensee hereby acknowledges and agrees that the development and use of the Licensed Property shall thereafter be in strict compliance with the approved plans and specifications or approved amendments thereto.

B. Licensee's Responsibilities. Licensee will be responsible for any damage to and/or for the relocation of existing facilities on the Licensed Property. Further, Licensee shall reimburse the County for all costs of replacing or repairing any property of the County or of others which are damaged or destroyed as a result of activities authorized under this Agreement by, or on behalf of, Licensee.

C. Maintenance. Licensee shall maintain the Licensed Property and the Licensee's Improvements by keeping the area free of debris and litter. Removal of dead or dying plants shall also be handled by Licensee at its expense, as required by the County. Such removal of dead or dying plants shall be completed within fifteen (15) days following receipt of a written request by

the County to do so. If Licensee abandons or fails to maintain the Licensed Property, and the County receives no substantive response within fifteen (15) days following written notification to Licensee, then the County may, in addition to any other remedy set out herein, remove and/or replace all of Licensee's Improvements.

D. Removal or Modification. Licensee agrees that removal or modification of any improvements now existing or to be later replaced on the Licensed Property shall be at Licensee's sole expense. Said removal or modification shall be at Licensee's sole discretion, except where otherwise provided by this Agreement; provided, however, any modification to existing Licensee's Improvements must comply with the Plan Review requirements set out herein.

E. Default. In the event that Licensee fails to maintain the Licensed Property or otherwise comply with the terms or conditions as set forth herein, then the County shall give Licensee written notice thereof to the Licensee at the address set forth below. Licensee shall have fifteen (15) days from the date of receipt of such notice to take action to remedy the failure complained of and, if Licensee does not remedy the same to County's complete satisfaction within the fifteen (15) period, the County may, in addition to other remedies available herein or by law to County, (1) perform the work, (2) contract for the completion of the work, or (3) terminate this Agreement. Licensee agrees to pay, within fifteen (15) days of written demand by the County, all costs and expenses incurred by the County in completing the work or contracting for the work to be completed.

VII. COMMENCEMENT; TERMINATION BY ABANDONMENT

This Agreement shall be effective as of the date of the last party's execution below ("Effective Date"), and continue thereafter for so long as the Licensed Property shall be used for the purposes set forth herein or until this Agreement is terminated according to the terms hereof.

If Licensee abandons the use of all or any part of the Licensed Property for such purposes set forth in this Agreement, then this Agreement, as to such portion or portions abandoned, shall expire and terminate following fifteen (15) days written notice to the Licensee. If such abandonment has not been remedied by Licensee within such period, the County shall thereafter have the same complete title to the Licensed Property so abandoned as though this Agreement had never been made and shall have the right to enter on the Licensed Property and terminate the rights of Licensee, its successors and assigns hereunder. All installations of Licensee's Improvements that are not removed prior to County's termination of the license subject of this Agreement shall be deemed property of the County as of the effective date of County's termination.

VIII. TERMINATION

A. Termination by Licensee. This Agreement, or portion of the Licensed Property, may be terminated by Licensee by delivering written notice of termination to the County not later than thirty (30) days before the effective date of termination. If Licensee so terminates, then Licensee shall, within the 30-day notice period, remove from the Licensed Property, or such other portion thereof that is being terminated, installations of Licensee's Improvements. Any of Licensee's Improvements that are not removed within said period shall become the property of the County. Licensee hereby agrees and acknowledges that Licensee shall be liable to County for any damages

caused to the Licensed Property by the removal of Licensee's Improvements.

B. Termination by County. In addition to any other termination rights set out herein, this Agreement may be revoked and terminated at any time by County if such revocation and termination is reasonably required by the public interest (as hereinafter set forth), after providing fifteen (15) days written notice to the Licensee.

Subject to prior written notification to Licensee or its successors-in-interest, revocation and termination of this Agreement is reasonably required by the public interest if:

1. the County deems, in its sole discretion, that Licensee's Improvements, or a portion of them, interfere with the County's right-of-way;
2. use of the Licensed Property becomes necessary for a public purpose;
3. the Licensee's Improvements, or a portion of them, constitute a danger to the public which the County deems, in its sole discretion, not to be remediable by alteration or maintenance of such improvements;
4. despite fifteen (15) days written notice to Licensee, the County deems, in its sole discretion, maintenance or alteration necessary to alleviate a danger to the public has not been made; or
5. Licensee fails to comply with the terms and conditions of this Agreement including, but not limited to, any insurance requirements specified herein.

IX. MISCELLANEOUS PROVISIONS

A. Venue and Governing Law. Each party to this Agreement hereby agrees and acknowledges that venue and jurisdiction of any suit, right, or cause of action arising out of or in connection with this Agreement shall lie exclusively in Williamson County, Texas. Furthermore, this Agreement shall be governed by and construed in accordance with the laws of the State of Texas, excluding, however, its choice of law rules.

B. Severability. If any provision of this Agreement shall be held invalid or unenforceable by any court of competent jurisdiction, such holding shall not invalidate or render unenforceable any other provision hereof, but rather this entire Agreement will be construed as if not containing the particular invalid or unenforceable provision or provisions, and the rights and obligation of the parties shall be construed and enforced in accordance therewith. The parties acknowledge that if any provision of this Agreement is determined to be invalid or unenforceable, it is the desire and intention of each that such provision be reformed and construed in such a manner that it will, to the maximum extent practicable, give effect to the intent of this Agreement and be deemed to be validated and enforceable.

C. Covenant Running With Land: Waiver of Default. This Agreement and all of the covenants herein shall run with the land; therefore, the conditions set forth herein shall inure to and bind each party's successors and assigns. Either party may waive any default of the other at any time, without affecting or impairing any right arising from any subsequent or other default.

D. Assignment. Licensee shall not assign, sublet or transfer its interest in this Agreement

without the written consent of the County, which consent shall not be unreasonably withheld. In the event County agrees to Licensee's assignment of its interest in this Agreement and subject to the assignee's compliance with the insurance requirements set forth herein, if any, Licensee shall furnish to the County a copy of any such assignment or transfer of any of Licensee's rights in this Agreement, including the name, date, address and contact person.

E. Notices. Excepts as specifically otherwise set forth herein, all notices, demands and requests for delivery of documents or information hereunder shall be in writing and shall be sent to the receiving party at the address identified below and be deemed to have been properly delivered and received (1) as of the time of delivery if personally delivered; (2) as of the time deposited in the mail system if sent by United States certified mail, return receipt requested, and postage prepaid; (3) as of the time of delivery to Federal Express (or comparable express delivery system) if sent by such method with all costs prepaid; or (4) as of the third (3rd) day following the date in which notice is sent by electronic mail (e-mail). All notices, demands and requests hereunder shall be addressed:

To Licensee At:

The address set forth below Licensee's signature block herein below.

To County At:

Williamson County Engineer
3151 S. E. Inner Loop, Suite B
Georgetown, Texas 78626

with copy to: Williamson County Judge
710 Main Street, Ste. 101
Georgetown, Texas 78626

or to such other addresses which either party may so designate by sending notice as aforesaid.

F. Day. Unless otherwise set forth herein, all references herein to a "day" shall mean a calendar day and not a business day.

G. No Third-Party Beneficiaries. This Agreement is for the sole and exclusive benefit of the parties hereto, and nothing in this Agreement, express or implied, is intended to confer or shall be construed as conferring upon any other person any rights, remedies or any other type or types of benefits.

H. Compliance with Laws. Each party to this Agreement shall comply with all federal, state, and local laws, statutes, ordinances, rules and regulations, and the orders and decrees of any courts or administrative bodies or tribunals in any matter affecting the performance of this Agreement

I. Gender, Number and Headings. Words of any gender used in this Agreement shall be held and construed to include any other gender, and words in the singular number shall be held to

include the plural, unless the context otherwise requires. The headings and section numbers are for convenience only and shall not be considered in interpreting or construing this Agreement.

J. Construction. Each party to this Agreement acknowledges that it and its counsel have reviewed this Agreement and that the normal rules of construction are not applicable and there will be no presumption that any ambiguities will be resolved against the drafting party in the interpretation of this Agreement.

K. No Waiver of Immunities. Nothing in this Agreement shall be deemed to waive, modify or amend any legal defense available at law or in equity to County, its past or present officers, employees, or agents or employees, nor to create any legal rights or claim on behalf of any third party. County does not waive, modify, or alter to any extent whatsoever the availability of the defense of governmental immunity under the laws of the State of Texas and of the United States.

L. Force Majeure. If the party obligated to perform is prevented from performance by reasons for which they are not responsible or circumstances beyond their control, including, but without limitation to, “acts of God”, abnormal weather conditions or other natural catastrophes, war, terrorist attacks, sabotage, computer viruses, riots, strikes, lockouts or other industrial disturbances, pandemics, epidemics, health emergencies, disease, plague, quarantine, travel restrictions, discovery of hazardous materials, differing or unforeseeable site conditions, acts of governmental agencies or authorities (whether or not such acts are made in response to other Force Majeure Events), or any other events or circumstances not within the reasonable control of the party affected, whether or not of a similar kind or nature to any of the foregoing (a “Force Majeure Event”). For the avoidance of doubt, Force Majeure Events include the Coronavirus (SARS Cov-2) and such related diseases (e.g. COVID- 19) outbreak., the other party shall grant such party relief from the performance of this Agreement. The burden of proof for the need of such relief shall rest upon the party obligated to perform. To obtain release based on force majeure, the party obligated to perform shall file a written request with the other party and take reasonable efforts undertaken to mitigate its effects.

M. Entire Agreement. This Agreement represents the entire and integrated Agreement between the parties hereto and supersedes all prior negotiations, representations, or agreements, either oral or written. This Agreement may be amended only by written instrument signed by each party to this Agreement. NO OFFICIAL, EMPLOYEE, AGENT, OR REPRESENTATIVE OF THE COUNTY HAS ANY AUTHORITY, EITHER EXPRESS OR IMPLIED, TO AMEND THIS AGREEMENT, EXCEPT PURSUANT TO SUCH EXPRESS AUTHORITY AS MAY BE GRANTED BY THE COUNTY COMMISSIONERS COURT.

TERMS AND CONDITIONS ACCEPTED, to be effective as of the date of the last party's execution below (the "Effective Date").

WILLIAMSON COUNTY, , TEXAS
a political subdivision of the State of Texas

By: Stm Snell

Printed Name: _____

Representative Capacity: As Presiding Officer of the
Williamson County Commissioners Court

Date: _____, 20__

THE STATE OF TEXAS §
 §
COUNTY OF WILLIAMSON §

This instrument was acknowledged before me on this the 20th day of November, 2025 by Steven Snell, as Presiding officer of the Williamson County Commissioners Court, on behalf of Williamson County, Texas.

Andrea L. Schiele

NOTARY PUBLIC, State of Texas

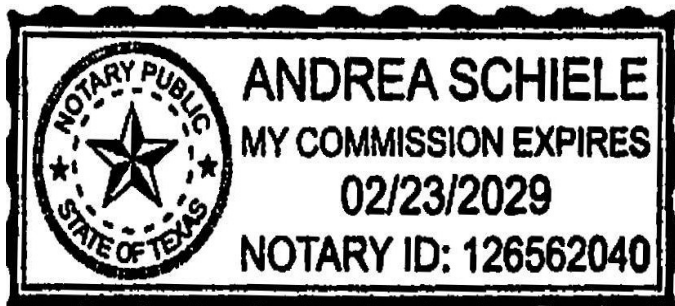

LICENSEE:

STONEWALL RANCH MUNICIPAL UTILITY DISTRICT

a conservation and reclamation district of the State of Texas

By: *Dallas Worth*

Printed Name: Dallas Worth

Title: Vice President

Date: April 21, 2025

Address for Notice:

4301 Bull Creek Road, Ste. 150
Austin, Texas 78731
E-mail: dallas.worth@swrmud.org

THE STATE OF TEXAS §

COUNTY OF TRAVIS §

This instrument was acknowledged before me on this the 21st day of April, 2025, by Dallas Worth, Vice President of Stonewall Ranch Municipal Utility District, a conservation and reclamation district of the State of Texas.

Kymerlee Izquierdo
NOTARY PUBLIC, State of Texas

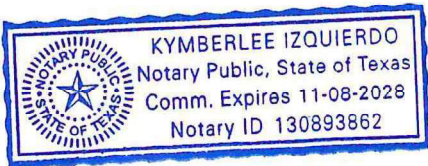

EXHIBIT "A"

LICENSED PROPERTY

The portions of all public rights-of-way between the edge of pavement or back of curb to the outer boundary of said rights-of-way within and adjacent to the portion of Capstone Road and Sandstone Road located within the Stonewall Ranch Subdivision and depicted on Exhibit "A-1". For reference, the Stonewall Ranch Subdivision is generally depicted on Exhibit "A-2".

EXHIBIT "A-1"
LICENSED PROPERTY

The Licensed Property shall consist of the following areas:

The West side of the public right-of-way area for Capstone Road, outside of the road pavement and any curb, in proximity to the intersection of Capstone Road and CR 213.

The North side of the public right-of-way for Sandstone Road, outside of the road pavement and any curb, in proximity to the intersection of Sandstone Road and CR 213

Distance: 9 ft.

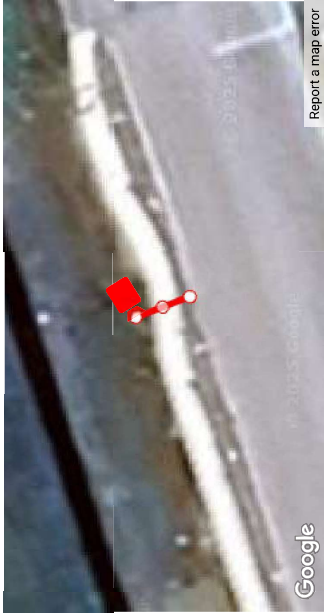

Position

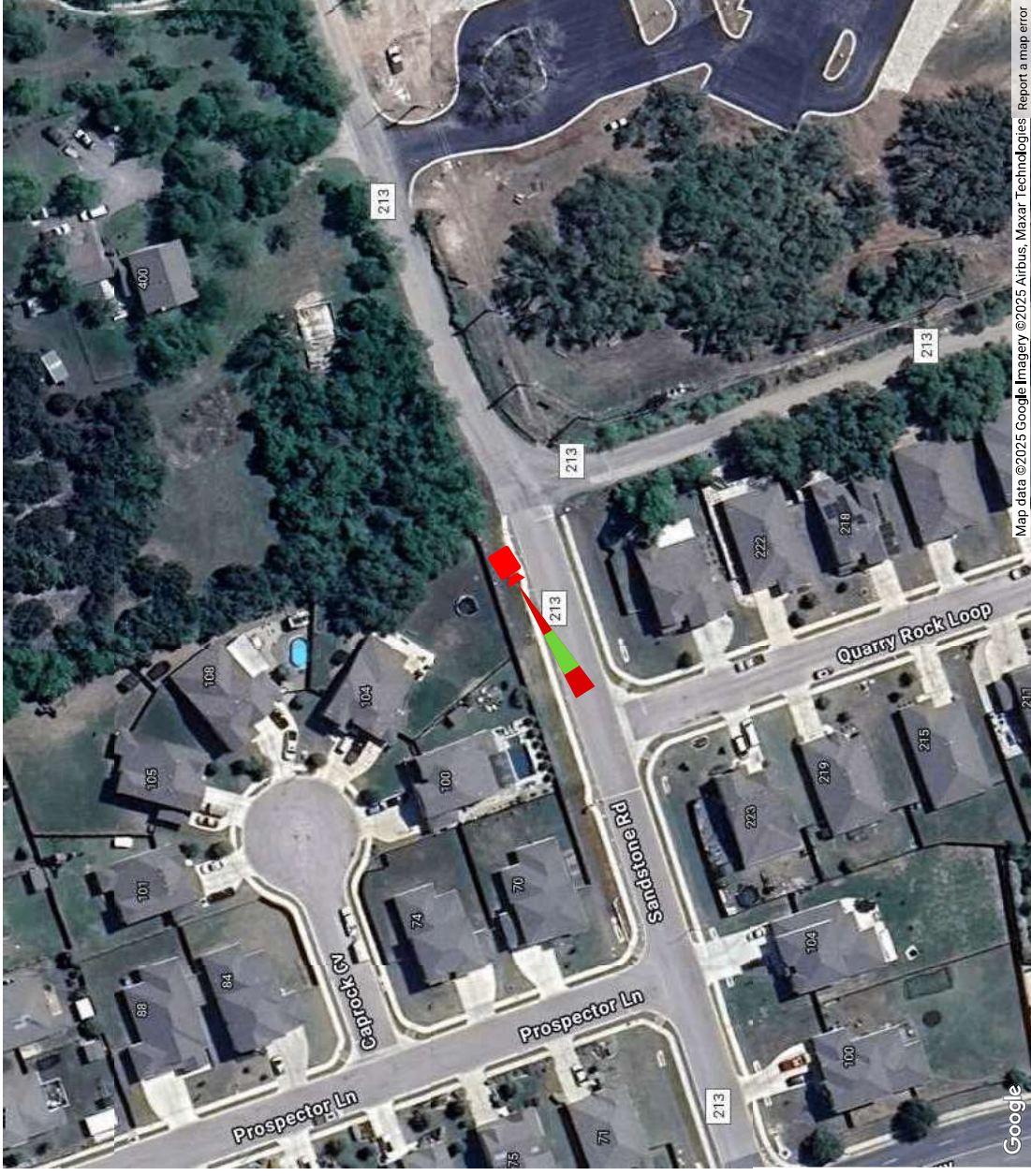

Location Notes: None

Property	Value
Camera Number	1
Name	F#002 Sandstone Rd Prospector Ln WB
Address	226 Quarry Rock Loop, Liberty Hill, TX 78642-4040, United States
Direction	Westbound
Lat	30.661382565507783
Lng	-97.88667190534656
Pole Type	
Distance from	9

TYPICAL DETAIL
FLOCK SAFETY CAMERAS ON
1/2" FLOCK POLE

flock safety
1170-HOWELL MILL ROAD SUITE 210
ATLANTA, GA 30318

REV.	DATE	BY	DESCRIPTION
-	-	-	-
-	-	-	-
-	-	-	-
0	08/02/2025	DAW	TYP. DETAIL

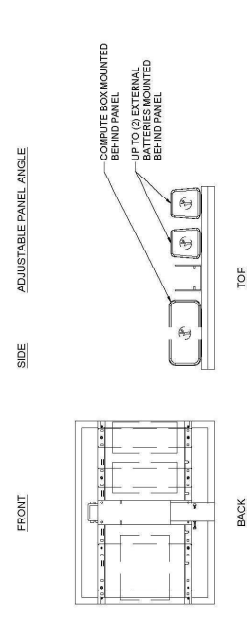
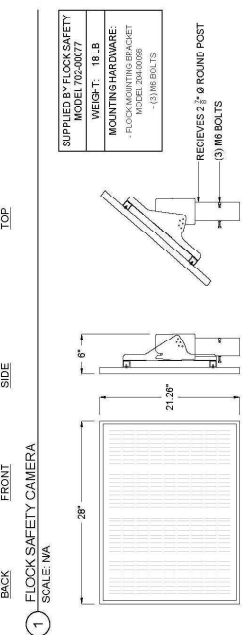
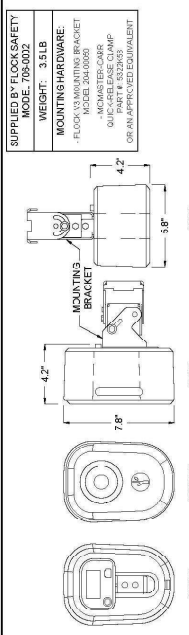
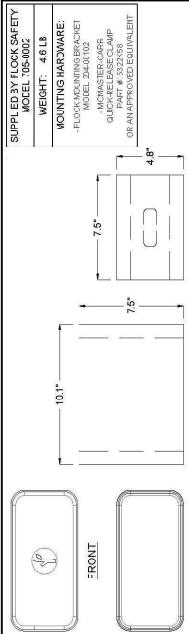

SUPPLIED BY FLOCK SAFETY
MODEL: 705-0002
WEIGHT: 4.6 LB

MOUNTING HARDWARE:
- FLOCK MOUNTING BRACKET
MODEL: 2816-0102
- NICHIMASTER-CARR
G-1000
PART # 832203-00P
OR AN APPROVED EQUIVALENT

SUPPLIED BY FLOCK SAFETY
MODEL: 705-0002
WEIGHT: 3.5 LB

MOUNTING HARDWARE:
- FLOCK MOUNTING BRACKET
MODEL: 2816-0102
- NICHIMASTER-CARR
G-1000
PART # 832203-00P
OR AN APPROVED EQUIVALENT

SUPPLIED BY FLOCK SAFETY
MODEL: 705-0007
WEIGHT: 18.8

MOUNTING HARDWARE:
- FLOCK MOUNTING BRACKET
MODEL: 2816-0102
- (3) #8 BOLTS

RECEIVES 2 1/2" Ø ROUND POST
(3) #8 BOLTS

SUPPLIED BY FLOCK SAFETY
MODEL: 705-0001
WEIGHT: 5.9 LB

MOUNTING HARDWARE:
- FLOCK MOUNTING BRACKET
MODEL: 2816-0102
- NICHIMASTER-CARR
G-1000
PART # 832203-00P
OR AN APPROVED EQUIVALENT

[THIS SPACE LEFT INTENTIONALLY BLANK FOR STAMP]

TX - Stonewall Ranch MUD
01201067

Flock Safety
1170 HOWELL MILL ROAD SUITE 210
ATLANTA, GA 30318

REV.	DATE	BY	DESCRIPTION
-	-	-	-
-	-	-	-
-	-	-	-
0	10/01/2025	FLK	PRELIM

I HEREBY CERTIFY THIS DOCUMENT WAS PREPARED BY MYSELF OR UNDER MY DIRECT SUPERVISION AND THAT I AM A DULY REGISTERED ENGINEER UNDER THE LAWS OF THE STATE OF TEXAS

[THIS SPACE LEFT INTENTIONALLY BLANK FOR STAMP]

FLOCK SAFETY EQUIPMENT
INSTALLATION

TYPICAL DETAILS	REV.
SHEET: SPEC.02	-

FLOCK SAFETY EQUIPMENT INSTALLATION
CASE NUMBER: 01201067
PERMITTING JURISDICTION: Williamson County (County of), Right-of-Way

COVER SHEET & LOCATION MAPS	
SHEET: SPEC.02	REV: 0

ITEM NO.	DESCRIPTION	QTY.
1	2.5" SCH 40 2 BTFS00 74.000L	1
2	2.5" SCH 40 2 BTFS00 94.000L	1
3	EUT TORX 0.250-20 TAMPER RESISTANT	6
4	INSERT SLEEVE STYLE 7 TAPPED	1
5	ORING	1
6	WASHER	6
7	CONCRETE FOOTING	1
8	F-BOLT 0.2500-20	1

PROVELI STYLE 7 COUPLER ASSEMBLY
 PART #: 1020-01
 MATERIAL: SCHED 40 6063 T6 ALUMINUM
 WEIGHT: 170.42 LBS
 DATE: 09/27/2023
 DO NOT SCALE DRAWINGS (NTS)

TYPICAL DETAIL
 FLOCK SAFETY CAMERAS ON
 1/2" FLOCK POLE

flock safety
 1170-HOWELL MILL ROAD SUITE 210
 ATLANTA, GA 30318

REV.	DATE	BY	DESCRIPTION	DATE	BY	DESCRIPTION	DATE	BY	DESCRIPTION
0	09/02/2023	DAW	TYP DETAIL	-	-	-	-	-	-

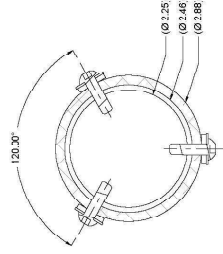

SECTION C-C

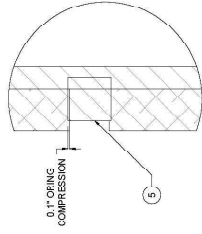

DETAIL D

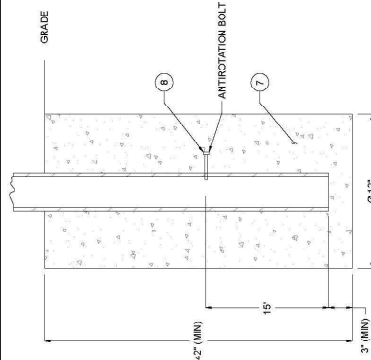

DETAIL E

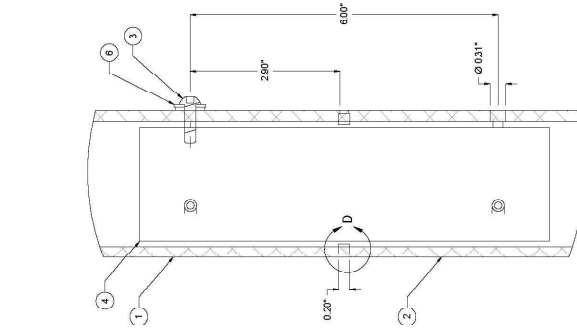

DETAIL F

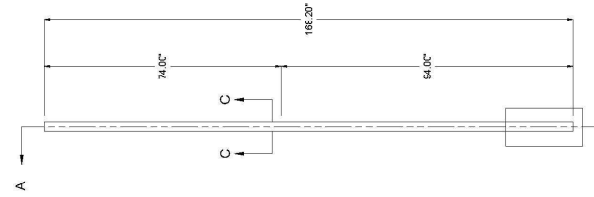

SECTION A-A

THE INFORMATION CONTAINED IN THIS DRAWING IS THE SOLE PROPERTY OF FLOCK SAFETY. ALL INFORMATION IS MARKED ONLY IN CASE OF THEORETICAL INFORMATION OF FLOCK SAFETY IS REQUIRED. DO NOT SCALE DRAWINGS.

TX - Stonewall Ranch MUD
 01201067

Flock Safety
 1170 HOWELL MILL ROAD SUITE 210
 ATLANTA, GA 30318

REV.	DATE	BY	DESCRIPTION
-	-	-	-
-	-	-	-
-	-	-	-
0	10/01/2025	FLK	PRELIM

I HEREBY CERTIFY THIS DOCUMENT WAS PREPARED BY MYSELF OR UNDER MY DIRECT SUPERVISION AND THAT I AM A DULY REGISTERED ENGINEER UNDER THE LAWS OF THE STATE OF TEXAS

[THIS SPACE LEFT INTENTIONALLY BLANK FOR STAMP]

FLOCK SAFETY EQUIPMENT INSTALLATION
 CASE NUMBER: 01201067
 PERMITTING JURISDICTION: Williamson County (County of), Right-of-Way

COVER SHEET & LOCATION MAPS
 SHEET: **SPEC.03** REV: **0**

THIS DOCUMENT HAS BEEN DRAWN BASED OFF THE MOST RECENT AVAILABLE DATA & AERIAL IMAGERY, THIS INCLUDES RIGHT OF WAY, EXISTING UTILITIES, & PRIVATE PROPERTY LINES. IT REMAINS THE RESPONSIBILITY OF OTHERS TO VERIFY ALL DATA PRIOR AND EXISTING SURROUNDING FACILITIES TO VERIFY & CONFLICTS ABOVE & BELOW GRADE, ALL CONSTRUCTION TO FOLLOW TEXAS DEPARTMENT OF TRANSPORTATION GENERAL GUIDELINES, DO NOT SCALE DRAWINGS, CALL 811 PRIOR TO DIGGING.

Distance: 4 ft.



Position

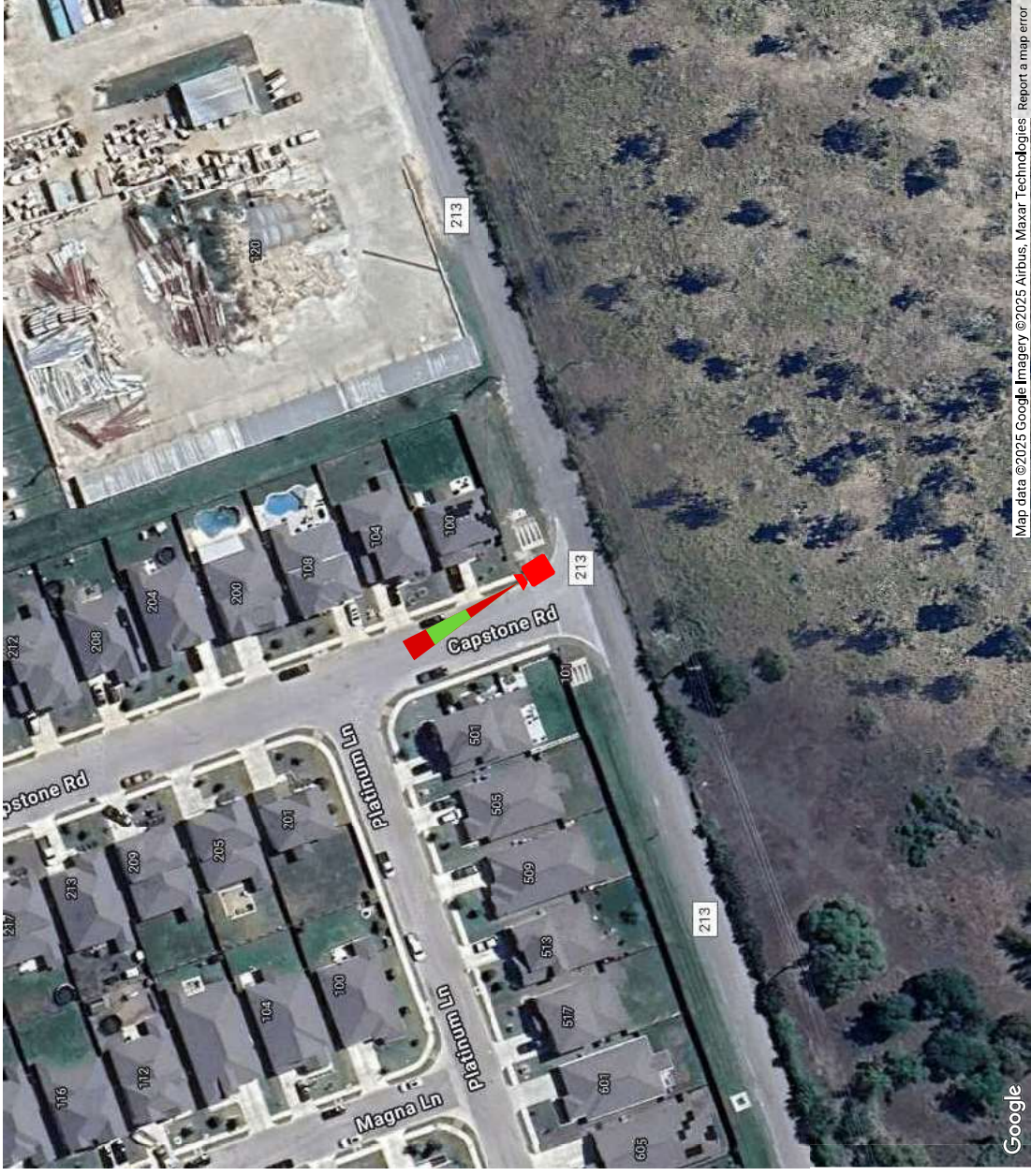

Location Notes: Does CX know who pole owner is ?

Property	Value
Camera Number	1
Name	F#001 CR-213 @ Capstone Rd WB
Address	100 Capstone Rd, Liberty Hill, TX 78642, United States
Direction	Northbound
Lat	30.662668
Lng	-97.882853
Pole Type	Existing Light Pole
Distance from Roadway (ft)	4

EXHIBIT "A-2"
DEPICTION OF LICENSED PROPERTY

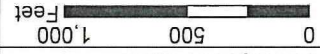
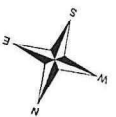

**Stonewall Ranch Municipal Utility District
 Land Use Plan - Use of Surplus Funds**

Legend: MUD BOUNDARY

